

TECHNICAL MANUAL

OPERATOR'S, ORGANIZATIONAL, AND DIRECT SUPPORT AND GENERAL SUPPORT MAINTENANCE MANUAL (INCLUDING REPAIR PARTS AND SPECIAL TOOLS LIST)

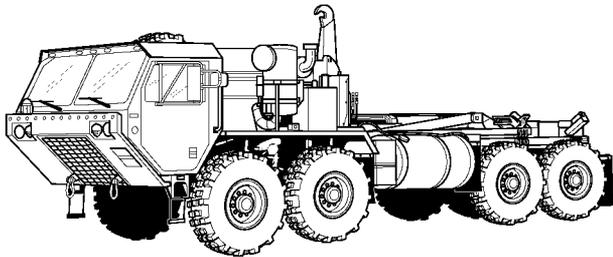

LOAD HANDLING SYSTEM, HEAVY EXPANDED MOBILITY TACTICAL TRUCKS (HEMTT)

MODEL M1120
NSN 2320-01-471-1326
Contract No. DAAE07-97-D-X010

Approved for public release; distribution is unlimited.

INTRODUCTION	1-1
OPERATING INSTRUCTIONS	2-1
OPERATOR/CREW PREVENTIVE MAINTENANCE CHECKS AND SERVICES TABLES	2-6
OPERATOR MAINTENANCE INSTRUCTIONS	3-1
ORGANIZATIONAL MAINTENANCE INSTRUCTIONS	4-1
DIRECT SUPPORT AND GENERAL SUPPORT MAINTENANCE	5-1
REFERENCES	A-1
MAINTENANCE ALLOCATION CHART (MAC)	B-1
REPAIR PARTS AND SPECIAL TOOLS LIST (RPSTL)	C-1
COMPONENTS OF END ITEM & BASIC ISSUE ITEMS LISTS	D-1
ADDITIONAL AUTHORIZED LIST	E-1
EXPENDABLE/DURABLE SUPPLIES AND MATERIALS LIST	F-1
STOWAGE AND SIGN GUIDE	G-1
ILLUSTRATED LIST OF MANUFACTURED ITEMS	H-1
TORQUE LIMITS	J-1
MANDATORY REPLACEMENT PARTS	K-1
INDEX	Index 1

CHANGE
NO. 1

HEADQUARTERS
DEPARTMENT OF THE ARMY
WASHINGTON D.C., 15 September 2001

TECHNICAL MANUAL
OPERATOR'S, ORGANIZATIONAL, AND
DIRECT SUPPORT AND
GENERAL SUPPORT
MAINTENANCE MANUAL
(INCLUDING REPAIR PARTS AND
SPECIAL TOOLS LIST)

LOAD HANDLING SYSTEM, HEAVY EXPANDED
MOBILITY TACTICAL TRUCKS (HEMTT)

MODEL M1120

NSN 2320-01-472-2731

Approved for public release; distribution is unlimited.

TM 9-2320-302-14&P, 15 August 2000, is changed as follows:

1. *Remove old pages and insert new pages as indicated below.*
2. *New or changed material is indicated by a vertical bar in the margin of the page.*
3. *Minor changes to illustrations are indicated by a miniature pointing hand.*
4. *Illustrations that are new or that have major revisions are indicated by a vertical bar adjacent to the illustration.*

Remove Pages

A thru B
a thru g/(h blank)
i thru iv
1-1 and 1-2
none
1-3 thru 1-8
none
1-9 thru 1-14
2-1 thru 2-6
none
2-11 thru 2-14
2-17 thru 2-20
2-25 thru 2-34

Insert Pages

A thru B
a thru l
i thru iv
1-1 and 1-2
1-2.1/(1-2.2 blank)
1-3 thru 1-8
1-8.1/(1-8.2 blank)
1-9 thru 1-15/(1-16 blank)
2-1 thru 2-6
2-8.1 thru 2-8.8
2-11 thru 2-14
2-17 thru 2-20
2-25 thru 2-34

Remove Pages

none
2-35 thru 2-38
2-81 and 2-82
none
2-83 and 2-84
none
2-85 and 2-86
none
3-1 and 3-2
none
3-3 and 3-4
none
3-7 and 3-8
none
4-1 and 4-2
none
4-3 and 4-4
none
4-9 thru 4-12
none
none
none
none
none
none
none
4-233 and 4-234
none
5-1 and 5-2
none
5-141 and 5-142
none
5-143 thru 5-148
none
A-1 and A-2
B-3 thru B-6
C-7 and C-8/(C-9 blank)
43-1/(43-2 blank) thru I-31/(I-32 blank)
D-1 and D-2
F-1 thru F-4
G-3/(G-4 blank)
K-1 and K-2
Index 1 thru Index 11/(Index 12 blank)
none
none
none

Insert Pages

2-34.1/(2-34.2 blank)
2-35 thru 2-38
2-81 and 2-82
2-82.1 thru 2-82.161/(2-82.162 blank)
2-83 and 2-84
2-84.1 thru 2-84.5/(2-84.6 blank)
2-85 and 2-86
2-86.1 thru 2-86.3/(2-86.4 blank)
3-1 and 3-2
3-2.1 thru 3-2.4
3-3 and 3-4
3-4.1/(3-4.2 blank)
3-7 and 3-8
3-8.1 thru 3-8.4
4-1 and 4-2
4-2.1/(4-2.2 blank)
4-3 and 4-4
4-8.1 thru 4-8.5/(4-8.6 blank)
4-9 thru 4-12
4-142.1 thru 4-142.20
4-168.1 thru 4-168.7/(4-168.8 blank)
4-170.1 thru 4-170.11/(4-170.12 blank)
4-184.1 thru 4-184.8
4-208.1 thru 4-208.2
4-212.1 thru 4-212.7/(4-212.8 blank)
4-228.1/(4-228.2 blank)
4-233 and 4-234
4-234.1 thru 4-234.76
5-1 and 5-2
5-140.1 and 5-140.2
5-141 and 5-142
5-142.1 thru 5-142.6
5-143 thru 5-148
5-225 thru 5-276
A-1 and A-2
B-3 thru B-7/(B-8 blank)
C-7 and C-8/(C-9 blank)
43-1 thru I-47/(I-48 blank)
D-1 thru D-3/(D-4 blank)
F-1 thru F-4
G-3 thru G-5/(G-6 blank)
K-1 thru K-3/(K-4 blank)
Index 1 thru Index 14
FP-4.1/(FP-4.2 blank)
FP-4.3/(FP-4.4 blank)
FP-6.1/(FP-6.2 blank)

File this change sheet in front of the publication for reference purposes.

By Order of the Secretary of the Army:

Official:



JOEL B. HUDSON
*Administrative Assistant to the
Secretary of the Army*
0110001

ERIC K. SHINSEKI
*General, United States Army
Chief of Staff*

DISTRIBUTION: To be distributed in accordance with the Initial Distribution Number (IDN) 381091, requirements for TM 9-2320-304-14&P.

WARNING

Carbon monoxide is without color or smell, but can cause death. Breathing air with carbon monoxide produces symptoms of headache, dizziness, loss of muscular control, a sleepy feeling, and coma. Brain damage or death can result from heavy exposure. Carbon monoxide occurs in the exhaust fumes of fuel-burning heaters and internal combustion engines. Carbon monoxide can become dangerously concentrated under conditions of no ventilation. Precautions must be followed to ensure crew safety when the personnel heater or engine of any vehicle is operated for any purpose.

1. DO NOT operate personnel heater or engine of vehicle in a closed place without proper ventilation.
2. DO NOT drive any vehicle with inspection plates, cover plates, or engine compartment covers removed unless necessary for maintenance purposes.
3. BE ALERT at all times during vehicle operation for exhaust odors and exposure symptoms. If either are present, IMMEDIATELY VENTILATE personnel compartments. If symptoms persist, remove affected crew to fresh air and keep warm. DO NOT PERMIT PHYSICAL EXERCISE. If necessary, give artificial respiration and get immediate medical attention. For artificial respiration, refer to FM 21-11.
4. BE AWARE that the gas particulate filter unit or the field protection mask for nuclear-biological-chemical protection WILL NOT offer safety from carbon monoxide poisoning.

WARNING

Adhesives, solvents, and sealing compound can burn easily, can give off harmful vapors, and are harmful to skin and clothing. To avoid injury or death, keep away from open fire and use in a well-ventilated area. If adhesive, solvent, or sealing compound gets on skin or clothing, wash immediately with soap and water.

WARNING

After removing deck, caution must be used not to get impaled on brackets.

WARNING

After tightening handnut, it may be necessary to loosen handnut slightly to align tab with handle lock plate.

WARNING

All personnel must stand clear during lifting operations. A swinging or shifting load may cause injury or death to personnel.

WARNING

Always lift stack of CROPs by connecting lift device to bottom CROP. Failure to comply may result in damage to equipment or severe injury or death to personnel.

WARNING

ALWAYS use air line respirators when using CARC paint unless air sampling shows exposure to be below standards. Use chemical cartridge respirator if air sampling is below standards.

WARNING

Arm assembly weighs 240 lbs. (109 kg). Attach suitable lifting device to prevent possible injury to personnel.

WARNING

BE AWARE of CARC paint exposure symptoms; symptoms can occur a few days after initial exposure. Seek medical help immediately if symptoms are detected.

WARNING

Bracket weighs 120 lbs. (54 kg). Attach suitable lifting device prior to installation to prevent possible injury to personnel.

WARNING

Bracket weighs 120 lbs. (54 kg). Attach suitable lifting device prior to removal to prevent possible injury to personnel.

WARNING

CARC paint contains isocyanate (HDI) which is highly irritating to skin and respiratory system. High concentrations of HDI can produce symptoms of itching and reddening of skin, a burning sensation in throat and nose, and watering of the eyes. In extreme concentrations, HDI can cause cough, shortness of breath, pain during respiration, increased sputum production, and chest tightness. The following precautions must be taken whenever using CARC paint:

- ALWAYS use air line respirators when using CARC paint unless air sampling shows exposure to be below standards. Use chemical cartridge respirator if air sampling is below standards.
- BE AWARE of CARC paint exposure symptoms; symptoms can occur a few days after initial exposure. Seek medical help immediately if symptoms are detected.
- DO NOT grind or sand painted equipment without high-efficiency air-purifying respirators in use.
- DO NOT let skin or eyes come in contact with CARC paint. Always wear protective equipment (gloves, ventilation mask, safety goggles, etc.).
- DO NOT use CARC paint without adequate ventilation.
- NEVER weld or cut CARC-coated materials.

WARNING

Check for overhead power lines or other obstructions before attempting LHS operation. LHS reaches a height of 17 ft. 2 in. (5.23 m) with ISO container. Serious injury or death to personnel could result from contact with electrical power lines.

WARNING

Check for overhead power lines or other obstructions before attempting LHS operations. LHS reaches a height of 18-ft. (5.5 mm). Injury or death could result if LHS contacts power lines.

WARNING

Check ground conditions for firmness and extreme sideways inclination before picking up or off-loading a flatrack. Any ground instability beneath road wheels could cause serious injury or death to personnel.

WARNING

Compressed air used for cleaning purposes shall not exceed 30 psi (207 kPa). Use only with effective chip guarding and personal protective equipment (goggles/shield, gloves, etc.), or injury to personnel may result.

WARNING

Compression frame weighs 800 lbs. (363 kg). Attach suitable lifting device prior to removal to prevent possible injury to personnel.

WARNING

Container lock could drop suddenly if not supported. Failure to comply may result in injury to personnel.

WARNING

CROP weighs 3,800 lbs. (1 724 kg). Six CROPs weigh 22,800 lbs. (10 342 kg). Make sure all personnel stand clear of CROP when CROP is being moved. Failure to comply may result in severe injury or death to personnel.

WARNING

Crossmember assembly weighs 530 lbs. (240 kg). Attach lifting device to prevent possible injury to personnel.

WARNING

Cylinder weighs in excess of 210 lbs. (95 kg). Attach suitable lifting device prior to lifting to prevent possible injury to personnel.

WARNING

Cylinder weighs in excess of 210 lbs. (95 kg). Attach suitable lifting device prior to installation or removal to prevent possible injury to personnel.

WARNING

Do not allow front lift adapter to contact the ground when half-height container front hooks are not engaged with container upper corner castings. Failure to comply may result in damage to equipment and injury or death to personnel.

WARNING

Do not attempt loading or unloading operations on a side slope greater than 5 degrees and/or fore/aft slope greater than 20 percent. Before attempting loading or unloading operations on slopes, determine if ground surface conditions permit safe loading or unloading operations. Slopes that contain snow, ice, loose gravel, or sand may not permit safe loading or unloading.

WARNING

Do not get under LHS when disconnecting or connecting connectors and hoses. A hydraulic malfunction could cause LHS to lower causing serious injury or death.

WARNING

DO NOT grind or sand painted equipment without high-efficiency, air-purifying respirators in use.

WARNING

DO NOT let skin or eyes come in contact with CARC paint. Always wear protective equipment (gloves, ventilation mask, safety goggles, etc.).

WARNING

Do not put hands, arms, or any body parts under container when positioning chock blocks. Failure to comply may result in injury or death to personnel.

WARNING

Do not reduce tire pressure when loaded with FRS or container. Highway tire pressure, 60 psi (414 kPa) front and 83 psi (572 kPa) rear, is required at all times when loaded with FRS or container. Failure to comply could result in damage to equipment and severe injury or death to personnel.

WARNING

Do not stand between front lift adapter and container. Truck could roll, crushing personnel, causing serious injury or death.

WARNING

DO NOT use CARC paint without adequate ventilation.

WARNING

Do not work on any item supported only by lift jacks or hoist. Always use blocks or proper stands to support the item prior to any work. Equipment may fall and cause injury or death to personnel.

WARNING

Drycleaning solvent (P-D-680) is TOXIC and flammable. Wear protective goggles, face shield, and gloves; use only in a well-ventilated area; avoid contact with skin, eyes, and clothes; and do not breathe vapors. Keep away from heat or flame. Never smoke when using solvent. The flashpoint for Type III Drycleaning Solvent is 200°F (93°C). Failure to do so may result in injury or death to personnel.

WARNING

Each strut bracket assembly weighs 30 lbs. (13.61kg) and cross bracket weighs 530 lbs. (240.40 kg). Attach suitable lifting device to prevent possible injury to personnel.

WARNING

Ensure hook arm assembly is supported with wooden blocks prior to removal to prevent possible injury to personnel.

WARNING

Ensure hook arm is supported with wooden blocks during installation to prevent possible injury to personnel.

WARNING

Ensure rail transport locking pins are disengaged before unloading flatrack. Rail transport locking pins are used for rail transport only. Failure to comply may result in damage to equipment.

WARNING

Ensure that flatrack runners contact LHS rear rollers correctly. Failure to contact flatrack runners correctly could result in serious injury or death to personnel and damage to equipment.

WARNING

Ensure that flatrack/FRS runners contact LHS rear rollers correctly. Failure to contact flatrack/FRS runners correctly could result in serious injury or death to personnel and damage to equipment.

WARNING

Ensure trailer air system is pressurized before beginning transfer, or flatrack locks may not properly engage/disengage. Serious injury or death to personnel could result.

WARNING

Environmental friendly high pressure washing creates hazardous noise levels and severe burn potential. Eye, skin, and ear protection is required. Failure to comply may result in injury to personnel.

WARNING

Front crossmember assembly weighs approximately 500 lbs. (227 kg). Attach suitable lifting device to prevent possible injury to personnel.

WARNING

Front lift adapter and hook weigh 1,750 lbs. (794 kg). Attach suitable lifting device prior to removal or installation to prevent possible injury to personal.

WARNING

Front lift adapter must be unloaded on a flat, level surface. Failure to comply may result in front lift adapter tipping over unexpectedly, causing injury or death to personnel.

WARNING

Front lift adapter weighs 1,600 lbs. (726 kg). Personnel must stay clear when installing or removing front lift adapter to LHS hook arm hook. Failure to comply may result in injury or death to personnel.

WARNING

Front lift adapter weighs 1,600 lbs. (726 kg). Attach suitable lifting device to prevent possible injury to personnel.

WARNING

Front lift adapter weighs 1600 lbs. (726 kg). Personnel must stay clear when installing or removing lifting frame to LHS hook arm hook. Failure to comply may result in injury or death to personnel.

WARNING

Fuel and oil are slippery and can cause falls To avoid injury, wipe up spilled fuel or oil with rags.

WARNING

Give off harmful vapors, and are harmful to skin and clothing. To avoid injury or death, keep away from open fire and use in well-ventilated area. If adhesive, solvent, or sealing compound gets on skin or clothing, wash immediately with soap and water.

WARNING

Hands may get pinched when installing container guide into slider. Hold container guides by outer edges of plate to avoid pinching between container guides and slider. Failure to comply may result in injury to personnel.

WARNING

Hook arm cylinder weighs 210 lbs. (95 kg). Attach suitable lifting device prior to removal or installation to prevent possible injury to personnel.

WARNING

Hook arm cylinder weighs 210 lbs. (95 kg). Attach suitable lifting device prior to lifting to prevent possible injury to personnel.

WARNING

Hook arm weighs 1,100 lbs. (499 kg). Attach suitable lifting device prior to removal or installation to prevent possible injury to personnel.

WARNING

Hook arm weighs 1,100 lbs. (499 kg). Attach suitable lifting device to prevent possible injury to personnel.

WARNING

Horizontal roller weighs 75 lbs (34 kg). Attach suitable lifting device prior to removal or installation to prevent possible injury to personnel.

WARNING

Hydraulic fluid is under great pressure. Engines on both trucks must be shut off while disconnecting hydraulic lines, steps (4) through (8). Failure to do so could cause serious injury or death to personnel.

WARNING

Hydraulic fluid is under great pressure. Engines on both trucks must be shut off while disconnecting hydraulic lines, steps (20) through (24). Failure to do so could cause serious injury or death to personnel.

WARNING

If ground is soft, jacking plate from truck BII or similar item may be positioned under support leg pad to prevent front lift adapter from sinking in ground.

WARNING

If LHS OVER LOAD indicator illuminates and normal operation has stopped, return load to original position and notify supervisor to have payload redistributed or weight reduced. Failure to comply may result in damage to equipment.

WARNING

If LHS OVER LOAD indicator illuminates but loading operation continues, operator is cautioned that LHS is nearing maximum capacity. In this situation, operator should notify supervisor if it appears payload is unevenly distributed in container or if container load exceeds 24,000 lbs. (10 886 kg). If any of these conditions exist, payload must be redistributed or reduced, or damage to equipment may result.

WARNING

If personnel become dizzy while using cleaning solvent, immediately get fresh air and medical help. If solvent contacts skin or clothes, flush with cold water. If solvent contacts eyes, immediately flush eyes with water and get immediate medical attention.

WARNING

ISO corner lock will become loose from front bottom corner casting of ISO container when performing step (5).

WARNING

It may be necessary to move the truck forward or backward slightly to get the slide arm upper front hooks to disengage.

WARNING

Keep all personnel away from rear of flatrack and chains while attempting to disengage the load locks. Chains will be under great tension and could unhook or fail, resulting in serious injury or death to personnel.

WARNING

Keep clear of equipment when equipment is being raised or lowered. Equipment may fall and cause serious injury or death to personnel.

WARNING

Left and right bumpers are identical. Right bumper is shown.

WARNING

Left front support bracket weighs 98 lbs. (44 kg). Attach suitable lifting device to prevent possible injury to personnel.

WARNING

LHS will only operate when transmission range selector is in N (Neutral).

WARNING

Lift hook weighs 200 lbs. (91 kg). Attach suitable lifting device prior to removal or installation to prevent possible injury to personnel.

WARNING

Lifting frame and hook weigh 1700 lbs. (771 kg). Attach suitable lifting device prior to removal or installation to prevent possible injury to personal.

WARNING

Load must be evenly distributed in the container. Uneven load distribution may cause the LHS OVER LOAD indicator to give false signals and cause the LHS to operate incorrectly. Damage to equipment may result.

WARNING

M1077 flatrack weighs 3,200 lbs. (1 452 kg). M1077A1 flatrack weighs 3,900 lbs. (1 769 kg). Attach suitable lifting device prior to removal or installation to prevent possible injury to personnel.

WARNING

Main frame and hook arm combined weight is 2,100 lbs. (953 kg). Hook arm cylinders weigh 210 lbs. (95 kg) each. Attach suitable lifting device prior to installation to prevent possible injury to personnel.

WARNING

Main frame and hook arm combined weight is 2,100 lbs. (953 kg). Attach suitable lifting device prior to removal to prevent possible injury to personnel.

WARNING

Main frame and hook arm combined weight is 2,100 lbs. (953 kg). Attach suitable lifting device prior to installation to prevent possible injury to personnel.

WARNING

Main frame and hook arm have a combined weight of 2,100 lbs. (953 kg). Hook arm cylinders weigh 210 lbs. (95 kg) each. Attach suitable lifting device prior to removal or installation to prevent possible injury or death to personnel.

WARNING

Main frame cylinder weighs 325 lbs. (148 kg). Attach suitable lifting device prior to installation to prevent possible injury to personnel.

WARNING

Main frame cylinder weighs 325 lbs. (148 kg). Attach suitable lifting device prior to removal to prevent possible injury to personnel.

WARNING

Main frame weighs 1,000 lbs. (454 kg). Attach suitable lifting device prior to removal to prevent possible injury to personnel.

WARNING

Main frame weighs 1,000 lbs. (454 kg). Attach suitable lifting device prior to installation to prevent possible injury to personnel.

WARNING

Main frame weighs 2,500 lbs. (1 135 kg). Attach suitable lifting device prior to removal to prevent possible injury to personnel.

WARNING

Main frame weighs 2,500 lbs. (1 135 kg). Attach suitable lifting device prior to installation to prevent possible injury to personnel.

WARNING

Main frame, hook arm, and hook have a combined weight of 2,300 lbs. (1 043 kg). Attach suitable lifting device prior to lifting to prevent possible injury to personnel.

WARNING

Make sure all personnel stand clear of CROP when CROP is being moved. failure to comply may result in severe injury or death to personnel.

WARNING

Make sure fingers and hands are not between strut front and rear halves. Fingers and hands could become pinched during assembly, causing injury to personnel.

WARNING

Make sure front lift adapter is free of snow, ice, and mud when installing on LHS. Front lift adapter may be unbalanced and may cause injury or death to personnel.

WARNING

Make sure hook arm is supported with lifting device during installation to prevent possible injury to personnel.

WARNING

Make sure lower container locks do not contact container. If lower container locks contact container lift hooks will disengage container causing container to drop and front lift adapter to become erratic. Failure to comply may result in injury or death to personnel.

WARNING

Make sure not to hold on to front of slider when stowing. Hands and fingers may be pinched between front of slider and hard lift bracket causing injury to personnel.

WARNING

Make sure operator, objects and other personnel are clear of LHS and truck during LHS operation or serious injury or death could result to personnel.

WARNING

Make sure parking brake is not applied before starting load sequence, or damage to equipment may occur.

WARNING

Make sure that all tension has been relieved between LHS hook and front lift adapter prior to unlocking front lift adapter lower container locks. Stay clear of front lift adapter when unlocking front lift adapter lower container locks as front lift adapter may separate from container unexpectedly. Failure to comply may result in serious injury or death to personnel.

WARNING

Make sure that container has contacted rear sliders correctly and is between guides. Failure to comply may result in serious injury or death to personnel and damage to equipment.

WARNING

Maximum permissible gross container weight is 24,000 lbs. (10 886 kg).

WARNING

Maximum side slope when loaded with a container is 30 percent. Failure to comply may result in equipment damage or severe injury or death to personnel.

WARNING

Maximum side slope when loaded with a FRS or container is 30 percent. Failure to comply may result in equipment damage or severe injury or death to personnel.

WARNING

Never crawl under equipment when performing maintenance unless equipment is securely blocked. Equipment may fall and cause serious injury or death to personnel.

WARNING

Never drive with LHS NO TRANSIT indicator illuminated. An illuminated indicator means LHS is not fully stowed. The load could break loose causing serious injury or death to personnel.

WARNING

Never use fuel to clean parts. Fuel is highly flammable. Serious personal injury could result if fuel ignites during cleaning.

WARNING

NEVER weld or cut CARC-coated materials.

WARNING

Oil will spray from cylinder manifold ports when rod is moved in or out. Cover ports with two cleaning cloths to prevent oil from spraying. Failure to comply may result in injury to personnel.

WARNING

On direct contact, uncured silicone sealant irritates eyes. In case of contact, flush eyes with water and seek medical attention. In case of skin contact, wipe off and flush with water.

WARNING

Personnel must stand clear of flatrack and lift hook areas during manual unload procedures or injury to personnel may result.

WARNING

Prior to and during any load or unload cycle, all personnel should stay clear of LHS and flatrack or serious injury or death to personnel could result.

WARNING

Prior to and during any load or unload cycle, all personnel should stay clear of LHS, front lift adapter, and container, or serious injury or death may result.

WARNING

Rail transport struts weigh 60 lbs. (27 kg). Use the aid of Soldier B when installing or removing rail strut. Failure to comply may result in injury to personnel.

WARNING

Rear guide assembly weighs 70 lbs. (32 kg). Attach lifting device to prevent possible injury to personnel.

WARNING

Rear roller assembly weighs 375 lbs (170 kg). Attach suitable lifting device prior to removal or installation to prevent possible injury to personnel.

WARNING

Rear roller bracket weighs 150 lbs. (68 kg). Attach suitable lifting device to prevent possible injury to personnel.

WARNING

Rear roller bracket weighs 150 lbs. (68 kg). When removing one rear roller bracket, make sure remaining rear roller bracket is supported. Attach suitable lifting device to prevent possible injury to personnel.

WARNING

Remove all jewelry such as rings, dog tags, bracelets, etc. If jewelry or tools contact positive electrical circuits, a direct short may result. Damage to equipment and injury or death to personnel may occur.

WARNING

Right front support bracket weighs 98 lbs. (44 kg). Attach suitable lifting device to prevent possible injury to personnel.

WARNING

Screws are extremely hot. Do not touch screws without protective gloves or severe burns to hands could result.

WARNING

Slide arm weighs 65 lbs. (29 kg). Attach suitable lifting device to prevent possible injury to personnel.

WARNING

Slider weighs 142 lbs. (64 kg). Attach suitable lifting device to prevent possible injury to personnel.

WARNING

Solvents used with a spray gun must be used in a spray booth with a filter. Face shield must be used by personnel operating spray gun. Failure to comply may result in injury to personnel.

WARNING

Steam cleaning creates hazardous noise levels and severe burn potential. Eye, skin, and ear protection is required. Failure to comply may result in injury to personnel.

WARNING

Stowage tray weights 72 lbs. (32.66 kg). Attach suitable lifting device to prevent possible injury to personnel.

WARNING

The LHS hydraulic system operates at oil pressures up to 1,725 psi (11 894 kPa). Never disconnect any hydraulic line or fitting without first dropping pressure to zero. Failure to comply may result in serious injury or death to personnel.

WARNING

These simplified procedures are to be used only as a guide. Full procedures for operation of the Container Handling Unit (CHU) are to be followed as authored in (Para 2-10.1 through 2-10.11).

WARNING

This is the symbol for a warning statement. WARNINGS describe a situation which could cause severe injury or death to personnel.

WARNING

Tip of removal tool is very sharp. Use caution when using tool. Failure to comply may result in injury to personnel.

WARNING

Tire pressure must be checked properly or serious injury or death to personnel may occur. Refer to TM 9-2320-279-10 for proper tire pressure check instructions.

WARNING

To disengage LHS hook arm from front lift adapter hook, it may be necessary to cycle LHS to unload after driving ahead slightly.

WARNING

To prevent corrosion, parts should be dipped in rust preventive within two hours of degreasing.

WARNING

To prevent injury to personnel, properly support stowage box.

WARNING

Trailer wheels must be chocked during transfer operations or serious injury or death to personnel could result.

WARNING

Two personnel must be used (driver and spotter) to position front lift adapter (FLA). Failure to comply may result in damage to equipment and injury or death to personnel.

WARNING

Unsafe welding practices can cause serious injury from fire, explosions, or harmful agents. Allow only authorized personnel to weld or cut metals, and follow safety precautions in TC 9-237. Protective clothing and goggles must be worn, adequate protective equipment used, a suitable fire extinguisher kept nearby, and requirements of TC 9-237 strictly followed.

WARNING

Use care when installing snap rings and retaining rings. Snap rings and retaining rings are under spring tension and can act as projectiles when released and can cause severe injury.

WARNING

Use care when removing springs. Springs are under tension and can act as projectiles when released and could cause injury to personnel.

WARNING

Use caution when working around front lift adapter. Front lift adapter may swing unexpectedly when not attached to container. Failure to comply may result in injury or death to personnel.

WARNING

When loaded with a container, the center of gravity is moved up and toward rear of truck. Extreme caution must be taken when turning and ascending or descending on a grade. Failure to use extreme caution could result in severe injury or death to personnel.

WARNING

When loaded with FRS, or container the center of gravity is moved up and toward rear of truck. Extreme caution must be taken when turning and ascending or descending on a grade. Failure to use extreme caution could result in severe injury or death to personnel.

WARNING

When loading or unloading containers on uneven ground (side slope up to 5 degrees and downgrades up to 20 percent), it may be necessary to apply truck service brakes to prevent truck rollaway or severe injury or death could result.

WARNING

When loading or unloading flatracks on uneven ground (side slope or downgrades up to 5 degrees), it may be necessary to apply truck service brakes to prevent truck rollaway or severe injury or death to personnel could result.

WARNING

When loading or unloading flatracks/FRS on uneven ground (side slope or down grades up to 5 degrees), it may be necessary to apply truck service brakes to prevent truck rollaway or severe injury or death to personnel could result.

WARNING

When operating M1120 truck with M1076 trailer, the heaviest loaded flatrack must always be placed on the truck, otherwise adverse handling and/or braking may result, causing injury or death to personnel.

INSERT LATEST UPDATED PAGES/WORK PACKAGES, DESTROY SUPERSEDED DATE

I LIST OF EFFECTIVE PAGES/WORK PACKAGES

NOTE: The portion of text affected by the updates is indicated by a vertical line in the outer margins of the page. Updates to illustrations are indicated by miniature pointing hands. Updates to wiring diagrams are indicated by shaded areas.

Dates of issue for original and updated pages/work packages are:

Original . . . 0 15 August 2000
 Change . . . 1 15 September 2001

TOTAL NUMBER OF PAGES IN THIS PUBLICATION IS 1312
 CONSISTING OF THE FOLLOWING:

Page/WP No.	*Revision No.	Page/UP No.	*Revision No.	Page/WP No.	Revision No.
Cover		2-9 - 2-10	0	2-87 - 2-109/	
a - I	1	2-11 - 2-13	1	(2-110 blank)	0
A - B	1	2-14 - 2-16	0	3-1 - 3-2	1
i	1	2-17	1	3-2.1 - 3-2.4	1
ii	0	2-18 - 2-19	0	3-3 - 3-4	1
iii	1	2-20	1	3-4.1/	
iv - v/(vi blank)	0	2-21 - 2-25	0	(3-4.2 blank)	1
I-1	1	2-26 - 2-34	1	3-5 - 3-7	0
I-2	0	2-34.1/(2-34.2 blank)	1	3-8	1
1-2.1/		2-35 - 2-36	1	3-8.1 - 3-8.4	1
(I-2.2 blank)	1	2-37	0	3-9/	
I-3 - I-8	1	2-38	1	(3-10 blank)	0
1-8.1/		2-39 - 2-81	0	4-1 - 4-2	1
(I-8.2 blank)	1	2-82	1	4-2.1	1
I-9	0	2-82.1 - 2-82.161/		(4-2.2 blank)	1
I-10 - I-15/		(2-82.162 blank)	1	4-3	1
2-1	1	2-83	0	4-4 - 4-8	0
2-2	0	2-84	1	4-8.1 - 4-8.5/	
2-3 - 2-4	1	2-84.1 - 2-84.5/		(4-8.6 blank)	1
2-5	0	(2-84.6 blank)	1	4-9	1
2-6	1	2-85	0	4-10 - 4-11	0
2-7 - 2-8	0	2-86	1	4-12	1
2-8.1 - 2-8.8	1	2-86.1 - 2-86.3/		4-13 - 4-142	0
		(2-86.4 blank)	1	4-142.1 - 4-142.20	1

* Zero in this column indicates an original page.

Page/WP No.	*Revision No.	Page/WP No.	*Revision No.	Page/WP No.	*Revision No.
4-143 - 4-168	0	5-225 - 5-276	1	FIG. 63 - 63-1/ (63-2 blank)	1
4-168.1 - 4-168.7/ (4-168.8 blank)	1	A-1	0	I-1 - I-47/ (I-48 blank)	1
4-169 - 4-170	0	A-2	1	D-1	0
4-170.1 - 4-170.11/ (4-170.12 blank)	1	B-1 - B-3	0	D-2 - D-3/ (D-4 blank)	1
4-171 - 4-184	0	B-4 - B-7/ (B-8 blank)	1	E-1/(E-2 blank)	0
4-184.1 - 4-184.8	1	C-1 - C-7	0	F-1	0
4-185 - 4-208	0	C-8/(C-9 blank)	1	F-2 - F-4	1
4-208.1 - 4-208.2	1	FIG. 1-1 - 27-1/ (27-2 blank)	0	G-1 - G-3	0
4-209 - 4-212	0	FIG. 28 - 28-1/ (28-2 blank)	0	G-4 - G-5/ (G-6 blank)	1
4-212.1 - 4-212.7/ (4-212.8 blank)	1	FIG. 29 - 29-2/ (29-3 blank)	0	H-1 - H-6	0
4-213 - 4-228	0	FIG. 30 - 31-1/ (31-2 blank)	0	J-1 - J-7/ (J-8 blank)	0
4-228.1/ (4-228.2 blank)	1	FIG. 32 - 32.2/ (32-3 blank)	0	K-1 - K-3/ (K-4 blank)	1
4-229 - 4-233	0	FIG. 33 - Fig. 43	0	Index 1 - Index 14	1
4-234	1	43-1 - 50-2/ (50-3 blank)	1	Authentication Page	0
4-234.1 - 4-234.76	1	FIG. 51 - 51-2/ (51-3 blank)	1	2028 Sample Front & Rear	0
4-235 - 4-236	0	FIG. 52 - 53-2/ (53-3 blank)	1	2028 Front & Rear	0
5-1	1	FIG. 54 - 59-4/ (59-5 blank)	1	FP-1/(FP-2 blank)	0
5-2 - 5-140	0	FIG. 60 - 60-1/ (60-2 blank)	1	FP-3/(FP-4 blank)	0
5-140.1 - 5-140.2	1	FIG. 61 - 62-1/(62-2 blank)	1	FP-4.1/(FP-4.2 blank)	1
5-141	0	FIG. 61 - 62-1/(62-2 blank)	1	FP-4.3/(FP-4.4 blank)	1
5-142	1	KITS-1 - KITS-2	1	FP-5/(FP-6 blank)	0
5-142.1 - 5-142.6	1	BULK-1	0	FP-6.1/(FP-6.2 blank)	1
5-143	0			FP-7/(FP-8 blank)	0
5-144 - 5-148	1				
5-149 - 5-224	0				

* Zero in this column indicates an original page.

TECHNICAL MANUAL

No. 9-2320-304-14&P

HEADQUARTERS
DEPARTMENT OF THE ARMY
Washington, DC, 15 August 2000

**OPERATOR’S, ORGANIZATIONAL MAINTENANCE, AND DIRECT SUPPORT
AND GENERAL SUPPORT MAINTENANCE MANUAL
(INCLUDING REPAIR PARTS AND SPECIAL TOOLS LIST)**

FOR

**LOAD HANDLING SYSTEM,
HEAVY EXPANDED MOBILITY TACTICAL TRUCKS (HEMTT)
MODEL M1120 NSN 2320-01-472-2731
Contract No. DAAE07-97-D-X010**

REPORTING ERRORS AND RECOMMENDING IMPROVEMENTS

You can help improve this publication. If you find any mistakes or if you know of a way to improve the procedures, please let us know. Submit your DA Form 2028-2 (Recommended Changes to Equipment Technical Publications), through the Internet, on the Army Electronic Product Support (AEPS) website. The Internet address is <http://aeps.ria.army.mil>. If you need a password, scroll down and click on “ACCESS REQUEST FORM”. The DA Form 2028 is located in the ONLINE FORMS PROCESSING section of the AEPS. Fill out the form and click on SUBMIT. Using this form on the AEPS will enable us to respond quicker to your comments and better manage the DA Form 2028 program. You may also mail, fax, or E-mail your letter, DA Form 2028, or DA Form 2028-2 direct to: Commander, U.S. Army Tank-automotive and Armaments Command, ATTN: AMSTA-LC-CIP-WT, Rock Island, IL 61299-7630. The email address is TACOM-TECH-PUBS@ria.army.mil. The fax number is DSN 793-0726 or Commercial (309) 782-0726.

TABLE OF CONTENTS

	Page
CHAPTER 1 INTRODUCTION	1-1
Section I. General Information	1-1
Section II. Equipment Description	1-6
Section III. Technical Principals of Operation	1-13
CHAPTER 2 OPERATING INSTRUCTIONS	2-1
Section I. Description and Use of Operator’s Controls and Indicators	2-1
Section II. Operator Preventive Maintenance Checks and Services	2-4
Section III. Operating Instructions	2-9
Section IV. Operating Instructions, Operations under Unusual Conditions	2-89
CHAPTER 3 OPERATOR MAINTENANCE INSTRUCTIONS	3-1
Section I. Lubrication Instructions	3-1
Section II. Troubleshooting Procedures	3-4
Section III. Maintenance Procedures	3-8.4

TABLE OF CONTENTS (CONT)

	Page
CHAPTER 4 ORGANIZATIONAL MAINTENANCE INSTRUCTIONS	4-1
Section I. General Information	4-2
Section II. Equipment Description and Data	4-3
Section III. Service Upon Receipt	4-3
Section IV. Preventive Maintenance Checks and Services (PMCS)	4-4
Section V. Troubleshooting	4-9
Section VI. Maintenance Procedures	4-143
CHAPTER 5 DIRECT SUPPORT AND GENERAL SUPPORT MAINTENANCE	5-1
Section I. Repair Parts, Special Tools, TMDE, and Support Equipment	5-2
Section II. Service Upon Receipt	5-2
Section III. Troubleshooting	5-2
Section IV. Direct Support/General Support Maintenance Introduction	5-74
Section V. Direct Support/General Support Maintenance Procedures	5-82
APPENDIX A REFERENCES	A-1
APPENDIX B MAINTENANCE ALLOCATION CHART (MAC)	B-1
Section I. Maintenance Allocation Chart	B-3
Section II. Tool and Test Equipment Requirements	B-4
Section III. Remarks	B-6
APPENDIX C REPAIR PARTS AND SPECIAL TOOLS LIST (RPSTL)	C-1
Section I. Introduction	C-1
Section II. Repair Parts List	C-7
APPENDIX D COMPONENTS OF END ITEM & BASIC ISSUE ITEMS LISTS	D-1
Section I. Introduction	D-1
Section II. Components of End Item	D-1
Section III. Basic Issue Items	D-2
APPENDIX E ADDITIONAL AUTHORIZED LIST	E-1
Section I. Introduction	E-1
Section II. Additional Authorized List	E-1
APPENDIX F EXPENDABLE/DURABLE SUPPLIES AND MATERIALS LIST	F-1
Section I. Introduction	F-1
Section II. Expendable/Durable Supplies and Materials List	F-2
APPENDIX G STOWAGE AND SIGN GUIDE	G-1
Section I. Introduction	G-1
Section II. Stowage and Sign Guide	G-3
APPENDIX H ILLUSTRATED LIST OF MANUFACTURED ITEMS	H-1
APPENDIX J TORQUE LIMITS	J-1
Section I. Introduction	J-1
APPENDIX K MANDATORY REPLACEMENT PARTS	K-1
Section I. Introduction	K-1
Section II. Mandatory Replacement Parts	K-1

LIST OF ILLUSTRATIONS

Figure	Title	Page
1-1	HEMTT Load Handling System Vehicle	1-2
2-1	LHS Controls and Indicators	2-2
3-1	Lubrication Points	3-2
4-1	General Tightening Sequences	4-149
4-2	Hydraulic Lines - M1120 Vehicle	4-236
5-1	General Tightening Sequences	5-81
FO-1	LHS Wiring Schematic	FP-1
FO-1.1	LHS-CHU Wiring Schematic	FP-4.1
FO-2	Chassis Electric Schematic	FP-5
FO-2.1	CHU Chassis Electric Schematic	FP-6.1
FO-3	Hydraulic Schematic	FP-7

LIST OF TABLES

Number	Title	Page
1-1	Equipment Data	1-8
1-2	Load Classification	1-13
2-1	Operator's Preventive Maintenance Checks and Services (Before)	2-7
2-2	Operator's Preventive Maintenance Checks and Services (After)	2-8
2-3	Operator's Preventive Maintenance Checks and Services for CHU (After)	2-8.1
3-1	Fault Symptom Index	3-4
3-2	Troubleshooting	3-5
4-1	Unit Level Preventive Maintenance Checks and Services (PMCS)	4-6
4-2	Load Handling System Fault Index	4-12
4-2.1	Container Handling Unit (CHU) Fault Index	4-12
4-3	Load Handling System (LHS) Troubleshooting	4-13
4-3.1	Container Handling Unit (CHU) Troubleshooting	4-142.1
4-4	Recommended Flats Rotation	4-148
4-4.1	CHU Control Box Wiring	4-170.5
4-5	Proximity Switch Wire Positions	4-172
5-1	Load Handling System Fault Index	5-4
5-2	Direct Support/General Support Troubleshooting	5-5
5-3	Recommended Flats Rotation	5-80
H-1	Wooden Blocks	H-1
J-1	Torque Limits For Wet Flange Nuts	J-2
J-2	Torque Limits For Wet Socket Head Cap Screws	J-2
J-3	Torque Limits For Dry Fasteners	J-4
J-4	Torque Limits For Wet Fasteners	J-5
J-5	Torque Limits For 37-Degree Flare Hose Connections	J-6
J-6	Torque Limits For 45-Degree Flare Hose Connections	J-6
J-7	Torque Limits For ORS Preformed Packing Face Seal Hose Connections	J-7
J-8	Torque Limits For NPSM Swivel Connections	J-7
K-1	Mandatory Replacement Parts	K-1

HOW TO USE THIS SUPPLEMENTAL MANUAL

This manual is designed to help operate and maintain the Heavy Expanded Mobility Tactical Truck (HEMTT) with Load Handling System (LHS) on Model M1120 Truck, with winch NSN 2302-01-472-2731, without winch NSN 2320-01-471-1326. This supplemental manual should be used in conjunction with the M977 series manual set to operate and maintain the HEMTT LHS vehicle. Listed below are some of the features included in this manual to help locate and use the needed information:

- A front cover Table of Contents is provided for quick reference to chapters and sections that will be used often.
- Warning, caution, and note headings, subject headings and other essential information are printed in bold type making them easier to see.
- In addition to text, there are exploded-view illustrations showing how to take a component off and put it back on. Cleaning and inspection criteria are also included where necessary.
- Chapter 1 of this manual supplements the M977 series manual set, describes the LHS, and provides equipment data.
- Chapter 2 of this manual supplements the TM 9-2320-279-10 manual with additional operating instructions.
- Chapter 3 of this manual supplements TM 9-2320-279-10 and covers additional instructions for Operator's Lubrication, Troubleshooting, and Unscheduled Maintenance.
- Chapter 4 of this manual supplements TM 9-2320-279-20 and provides Organizational Maintenance instructions for the LHS.
- Chapter 5 of this manual supplements TM 9-2320-279-34 and provides Direct Support and General Support Maintenance instructions for the LHS.
- Appendix A covers the References used in this manual.
- Appendix B supplements TM 9-2320-279-20 and covers the Maintenance Allocation Chart (MAC) for the LHS.
- Appendix C supplements TM 9-2320-279-24P and covers the Repair Parts and Special Tools List (RPSTL) for the LHS.
- Appendix D supplements TM 9-2320-279-10 and covers the Components of End Item (COEI) and Basic Issue Items (BII) Lists for the LHS.
- Appendix E supplements TM 9-2320-279-10 and covers the Additional Authorized List (AAL) of items authorized for the LHS.
- Appendix F supplements M977 series manual set and covers the Expendable and Durable Supplies and Materials List for the LHS.
- Appendix G supplements TM 9-2320-279-10 and covers the Stowage and Sign Guide for the LHS.
- Appendix H supplements TM 9-2320-279-10 and covers the Illustrated List of Manufactured Items for the LHS.
- Appendix J supplements TM 9-2320-279-10 and covers the Torque Limits for the LHS.
- Appendix K supplements TM 9-2320-279-10 and covers the Mandatory Replacement Parts for the LHS.
- An Alphabetical Index is provided to help locate items in the text.

The vehicles referenced in the TM 9-2320-279-10, TM 9-2320-279-20, TM 9-2320-279-24P, TM 9-2320-279-34, and TM 9-2815-224-34&P manuals are similar, but not identical, to the vehicle referenced in this supplemental manual. HEMTT LHS truck procedures that are common to the M977 can be found in the -10, -20, -24P, -34, and -34&P manuals. Configuration differences can be determined by visually inspecting the vehicle prior to maintenance.

Follow these guidelines when using this manual:

- Read all WARNINGS and CAUTIONS before performing any procedure.
- The driver must read this supplemental manual along with TM 9-2320-279-10 and become familiar with the content of each manual before attempting to operate the vehicle.
- Maintenance personnel must read this supplemental manual along with the M977 series maintenance manuals (-20, -24P, -34, and -34&P) and become familiar with the content of each manual before performing any maintenance to the vehicle.

CHAPTER 1 INTRODUCTION

Contents	Para	Page
Scope	1-1	1-1
Maintenance Forms and Records	1-2	1-3
Equipment Improvement Report and Maintenance Digest (EIR MD) and Equipment Improvement Report and Maintenance Summary (EIR MS)	1-3	1-3
Hand Receipt (HR) Manuals	1-4	1-3
Submitting Quality Deficiency Reports (QDR)	1-5	1-3
Warranty Information	1-6	1-4
Metric System	1-7	1-4
Reference Information	1-8	1-4
Equipment Characteristics, Capabilities, and Features	1-9	1-6
Location and Description of Major Components	1-10	1-7
Equipment Data	1-11	1-8
Systems Introduction	1-12	1-13
Load Handling System (LHS)	1-13	1-13
Container Handling Unit (CHU)	1-14	1-15

Section I. General Information

1-1. SCOPE.

This manual supplements the M977 series manual set. This manual is used for operation and maintenance of the M1120 series truck equipped with a Load Handling System (LHS) capable of self-loading and unloading. See Figure 1-1.

This manual is also used for operation and maintenance of the M1120 series truck equipped with the Container Handling Unit (CHU). See Figure 1-2.

Introduction (Cont)

1-1 SCOPE (CONT).

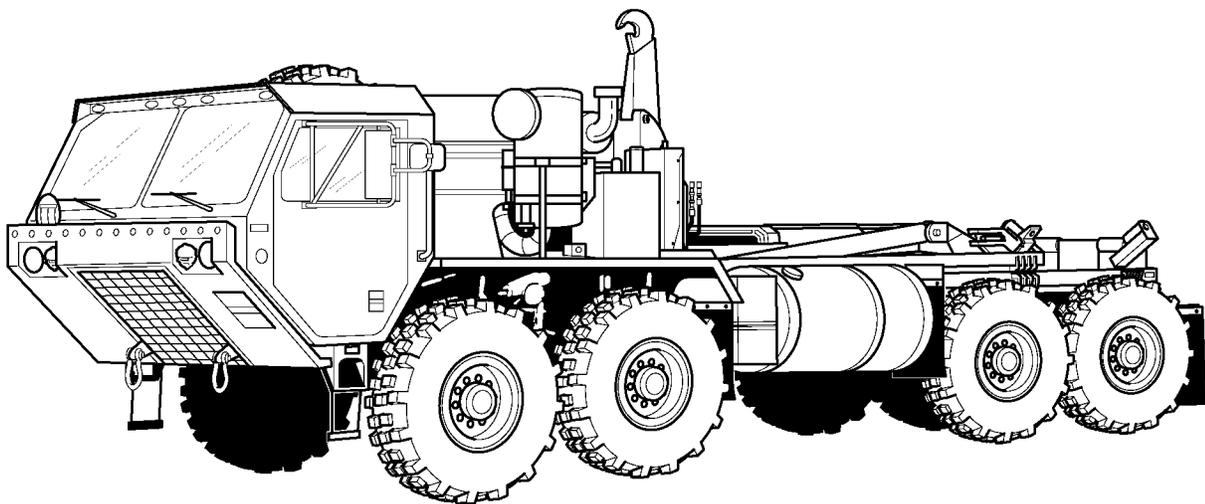
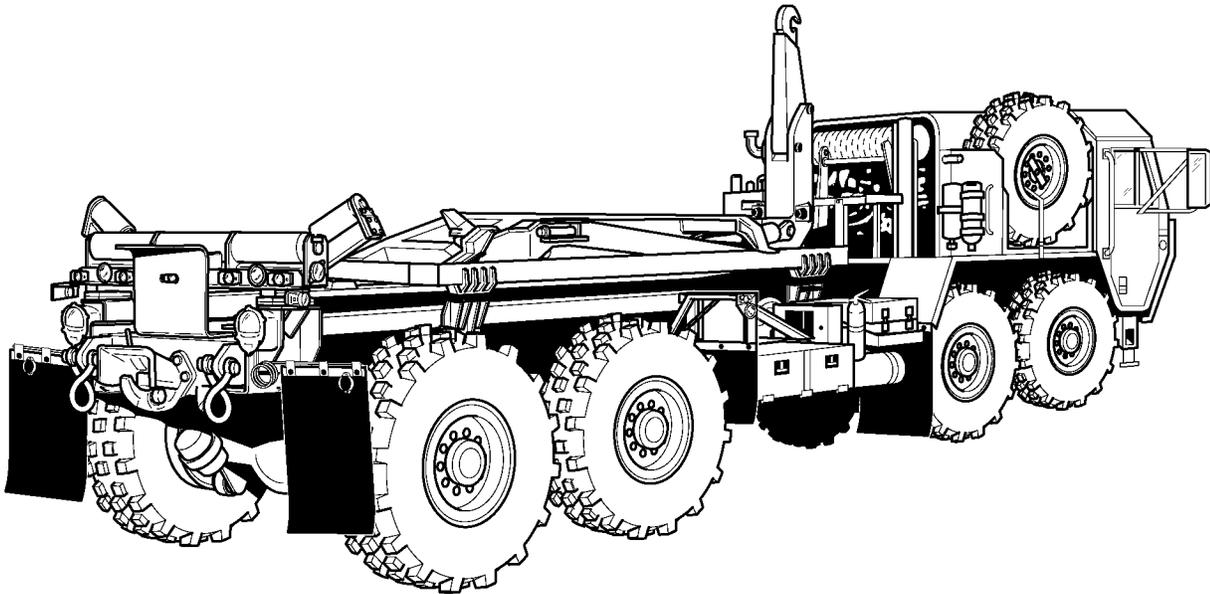

Figure 1-1. HEMTT Load Handling System Vehicle.

Introduction (Cont)

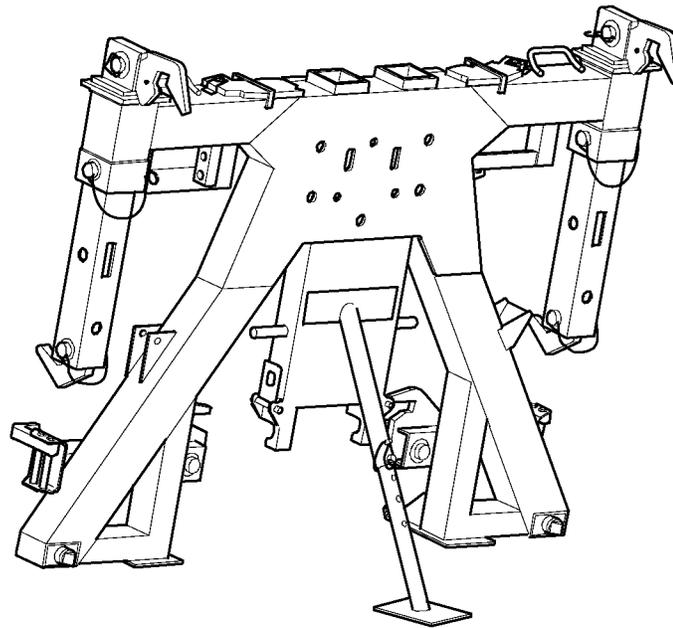
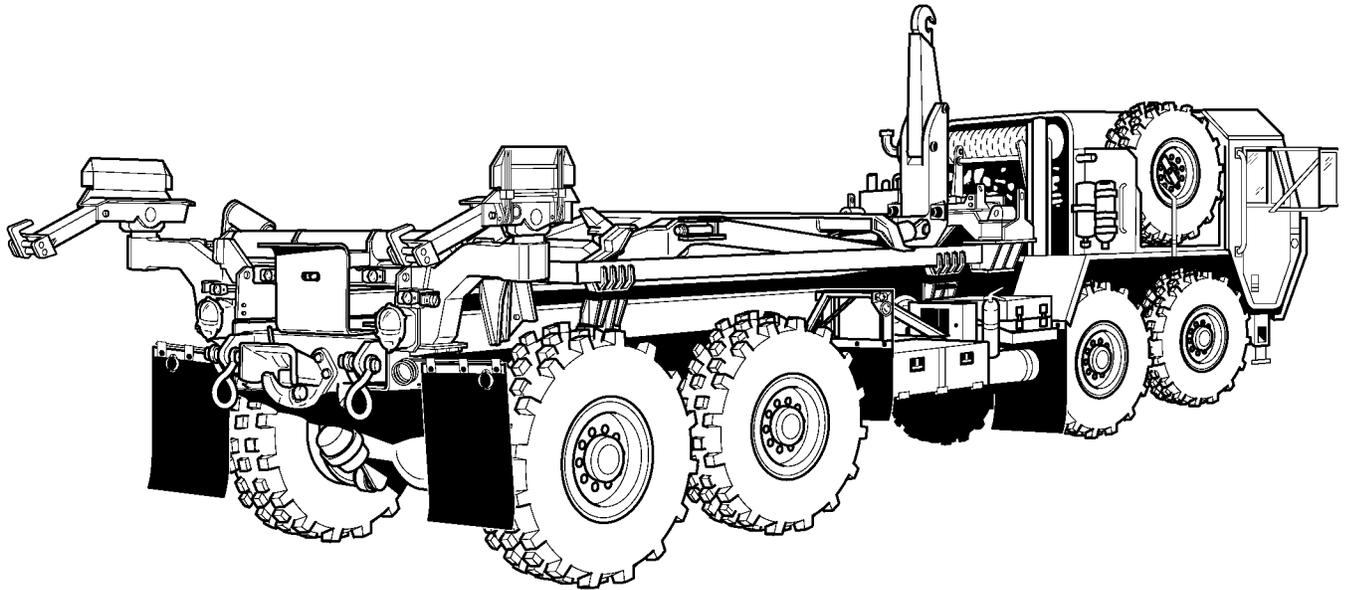

Figure 1-2. HEMTT LHS with Container Handling Unit (CHU)

Introduction (Cont)

1-2. MAINTENANCE FORMS AND RECORDS.

Department of the Army forms and procedures used for equipment maintenance will be those prescribed by DA PAM 738-750, The Army Maintenance Management System (TAMMS) (Maintenance Management UPDATE).

1-3. EQUIPMENT IMPROVEMENT REPORT AND MAINTENANCE DIGEST (EIR MD) AND EQUIPMENT IMPROVEMENT REPORT AND MAINTENANCE SUMMARY (EIR MS).

The quarterly Equipment Improvement Report and Maintenance Digest, TB 43-0001-62 series, contains valuable field information on equipment covered in this manual. Information in the TB 43-0001-62 series is compiled from some of the Equipment Improvement Reports that have been prepared on vehicles covered in this manual. Many of these articles result from comments, suggestions, and improvement recommendations that were submitted to the EIR program. The TB 43-0001-62 series contains information on equipment improvements, minor alterations, proposed Modification Work Orders (MWOs), warranties (if applicable), actions taken on some of the DA Form 2028s (Recommended Changes to Equipment Technical Publications), and advance information on proposed changes that may affect this manual. Significant maintenance articles, including minor alterations and field-fixes, are republished in the Equipment Improvement Report and Maintenance Summary (EIR MS) for TACOM Equipment (TM 43-0143). Refer to the TB 43-0001-62 series and TM 43-0143 periodically for the most current and authoritative information on the equipment. The information will help to do a better job and will advise of the latest changes to this manual. Also refer to DA Pam 310-1, Consolidated Index of Army Publications and Blank Forms, and Appendix A, References, of this manual.

1-4. HAND RECEIPT (HR) MANUALS.

This manual has a companion document with a TM number followed by “-HR” (Hand Receipt). The TM 9-2320-279-10-HR consists of preprinted hand receipts (DA Form 2062) that list end item related equipment (COEI, BII, and AAL) which must be accounted for. As an aid to property accountability, additional -HR manuals may be requisitioned from the following source in accordance with procedures in Chapter 3, AR 310-2: Commander

US Army Adjutant General Publications Center
ATTN: AGDM-OD
2800 Eastern Blvd.
Baltimore, MD 21220

1-5. SUBMITTING QUALITY DEFICIENCY REPORTS (QDR).

If your vehicle needs improvement, let us know. Send us a QDR. You, the user, are the only one who can tell us what you don't like about your equipment. Let us know why you don't like the design or performance. Put it on an SF368 (Quality Deficiency Report). Mail it to:

Department of the Army
U.S. Army Tank-automotive and Armaments Command
ATTN: AMSTA-TR-E-PQDR MS 267
Warren, MI 48397-5000

A reply will be sent to you.

Introduction (Cont)

1-6. WARRANTY INFORMATION.

The M1120 series vehicles are warranted by Oshkosh Truck Corporation for 12 months or 12,000 miles (19 308 km), whichever comes first. The warranty starts on the date found in block 23, DA Form 2408-9, in the logbook. Report all defects in material or workmanship to the supervisor, who will take appropriate action through the organizational maintenance shop. Refer to TB 9-2320-279-14 for more information on the warranty procedures for the M1120 series vehicles.

1-7. METRIC SYSTEM.

The equipment described herein contains metric components and requires metric, common, and special tools. Therefore, metric units and English units will be used throughout this publication. An English-to-metric conversion table is included as the last page of this manual inside the back cover.

1-8. REFERENCE INFORMATION.

This listing includes a nomenclature cross-reference list and a list of abbreviations used in this manual.

a. Nomenclature Cross-Reference List

Common Name	Official Nomenclature
Engine Coolant	- Antifreeze, ethylene glycol mixture
Cold Start System	- Ether quick start system
Cable	- Wire rope
Glad Hand	- Quick disconnect air coupling
Throttle Pedal	- Throttle control
Service Brake Pedal	- Brake pedal
Jake Brake	- Engine brake

b. Abbreviations.

AAL	Additional Authorization List
amp	Amperes
AOAP	Army Oil Analysis Program
BII	Basic Issue Item
C	Centigrade
CAGE	Commercial and Government Entity
CBR	Chemical, Biological, Radiological
CCA	Cold Cranking Amps
CHU	Container Handling Unit
cid	Cubic Inch Displacement
CKT	Circuit
cm	Centimeter
COEI	Components of End Item
CROP	Container Roll-in/Out Platform
CTA	Common Table of Allowance
DA	Department of the Army
EIR	Equipment Improvement Recommendation

Introduction (Cont)

F	Fahrenheit
FLA	Front Lift Adapter
fl. oz.	Fluid Ounce
FR	Flatrack
FRS	Forward Repair System
ft.	Foot
gal	Gallon
GCWR	Gross Combination Weight Rating
GPFU	Gas Particulate Filter Unit
GVWR	Gross Vehicle Weight Rating
HDI	Isocyanate
hp	Horsepower
in.	Inch
I.D.	Inside Diameter
ISO	International Standards Organization
JTA	Joint Tables of Allowances
kg	Kilogram
km/h	Kilometers Per Hour
kPa	Kilopascal
kw	Kilowatt
L	Liter
lb-ft.	Pound-Foot
lb-in.	Pound-Inch
lb.	Pound
LHS	Load Handling System
m	Meter
mi.	Mile
ml	Milliliter
mm	Millimeter
mph	Miles Per Hour
N•m	Newton Meters
NBC	Nuclear, Biological, Chemical
O.D.	Outside Diameter
OTC	Oshkosh Truck Corporation
oz	Ounce
PMCS	Preventive Maintenance Checks and Services
psi	Pound-Force Per Square Inch
pt.	Pint
PTO	Power Takeoff
qt.	Quart
RFI	Radio-Frequency Interference
rpm	Revolutions Per Minute
SAE	Society of Automotive Engineers
SRW	Self-Recovery Winch
TAMMS	The Army Maintenance Management System
TDA	Tables of Distribution and Allowance
TM	Technical Manual
Vdc	Volts direct current
XHD	Extra Heavy Duty

Introduction (Cont)

Section II. Equipment Description

1-9. EQUIPMENT CHARACTERISTICS, CAPABILITIES, AND FEATURES.

a. Characteristics. The HEMTT with LHS is a tactical wheeled truck with integral self-load/unload capability. Major subsystems of truck are: cab, engine, transmission, drive train, suspension, electrical system, hydraulic system, pneumatic system, and load handling system (LHS).

b. Capabilities.

- (1) All models are capable of operating in temperatures from -25 to 120°F (-32 to 49°C) and to -50°F (-46°C) with the arctic kit installed.
- (2) All models can ford water up to 48 in. (1 219 mm) deep for five minutes without damage or requiring maintenance before operation can continue.
- (3) Normal operating range for truck is 300 mi. (483 km) based on 154 gal (583 L) of fuel and 103,000 lb. (46 720 kg) GVCWR, traveling over mixed terrain. Varying loads, prolonged idle, use of the LHS, off-road driving and, climatic conditions affect operating range.
- (4) All models are provided with sufficient tiedown points located so that the truck can be restrained in all directions during air transport. All models are capable of transport by highway, rail, and sea.

c. Features.

- (1) Eight-cylinder, V-type, two-cycle, fuel-injected, turbocharged diesel engine.
- (2) High/low range transfer case.
- (3) Power steering system consists of basic manual steering system with a hydraulic boost.
- (4) Mechanical linkage also provides operator control in event of hydraulic oil pressure loss.
- (5) Fuel system includes one main fuel tank, fuel lines, fuel water separator, fuel pump, secondary fuel filter, fuel pipes, and fuel injectors.
- (6) Two front and two rear towing eyes.
- (7) Manual-release-type rear self-guided coupler allows towing of trailer.
- (8) Radio frequency interference suppression to permit voice radio communications during all phases of operation.
- (9) LHS enables a single operator to load a flatrack to a truck and/or a trailer.
- (9.1) LHS enables a single operator to load the Forward Repair System (FRS) to a truck, but not a trailer.
- (9.2) Container Handling Unit (CHU) capable of lifting ISO containers and shelters onto truck.
- (10) The sideboard kit and tiedowns on the flatrack allow the truck to carry bulk loads.
- (11) Multiple warning indicators, gages, and buzzers protect the systems from damage by warning the operator about unsafe operating conditions.
- (12) Circuit breakers protect electrical system from damage and can be reset from cab.
- (13) LHS has backup systems in the event of hydraulic or electrical system failure.
- (14) Each truck is fitted for a Gas Particulate Filter Unit (GPFU) that would mount in the cab.

Introduction (Cont)

1-10. LOCATION AND DESCRIPTION OF MAJOR COMPONENTS.

Major components and accessories found on M1120 are illustrated and described below.

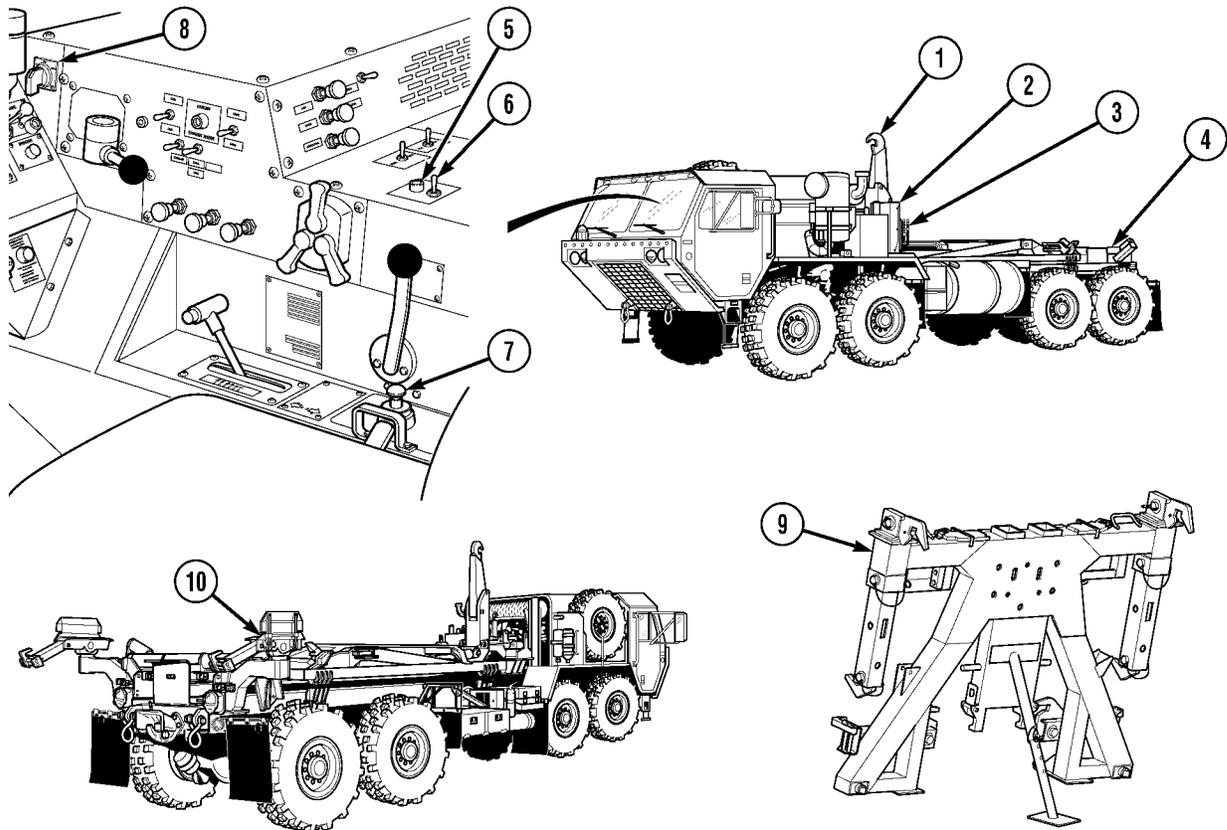

1. **HOOK.** Used to load/unload flatrack.
2. **CONTROL BOX.** Houses LHS controls.
3. **HYDRAULIC CONNECTIONS.** Used to supply hydraulic power to LHS. Also used in an emergency to operate LHS using another truck.
4. **ROLLERS.** Help guide flatrack onto trucks.
5. **PTO INDICATOR.** Illuminates when PTO is engaged.
6. **PTO ENGAGE SWITCH.** Engages and disengages PTO.
7. **JOYSTICK.** Used to control LHS.
8. **HYDRAULIC SELECTOR SWITCH.** Used to turn the LHS on and off.
9. **CONTAINER HANDLING UNIT (CHU) FRONT LIFT ADAPTER.** Used to load/unload ISO containers and shelters onto truck.
10. **REAR SLIDER ASSEMBLY.** Used to guide containers onto truck.

Introduction (Cont)

1-11. EQUIPMENT DATA.

Refer to Table 1-1 for typical equipment data for the HEMTT with LHS.

Table 1-1. Equipment Data

Model	Item
M1120	<p>DIMENSIONS</p> <p>Width (overall): 96 in. (2 438 mm)</p> <p>Height (overall): 148 in. (3 759 mm)</p> <p>Height (reduced for shipping): 102 in. (2 591 mm)</p> <p>Length (overall): 393 in. (9 982 mm)</p> <p>Wheelbase: 210 in. (5 334 mm)</p> <p>Turning Circle (wall-to-wall): 100 ft. (31 m)</p> <p>Ground Clearance: 24 in. (610 mm)</p> <p>Center of Gravity: See shipping data plate on left rear outside of cab.</p>
M1120 w/CHU	<p>DIMENSIONS</p> <p>Width (overall): 101 in. (256.5 cm).</p> <p>Height (overall): 171 in. (434.3 cm).</p> <p>Length (overall): 424 in. (1077 cm).</p>
M1120	<p>WEIGHT</p> <p>Curb Weight: 36,500 lb. (16 556 kg)</p> <p>Gross Vehicle Weight Rating: 66,000 lb. (29 937 kg)</p> <p>Gross Combination Weight Rating: 103,000 lb. (46 720 kg)</p>
M1120 w/CHU	<p>WEIGHT</p> <p>Curb Weight: 40,300 lb. (18 280 kg).</p> <p>Gross Vehicle Weight Rating: 66,000 lb. (29 937 kg).</p> <p>Gross Combination Weight Rating: 103,000 lb. (46 720 kg).</p>
M1120	<p>WEIGHT DISTRIBUTION</p> <p>Front Tandem Axles - Curb: 23,200 lb. (10 523 kg)</p> <p>Front Tandem Axles - Loaded: 30,000 lb. (13 608 kg)</p> <p>Rear Tandem Axles - Curb: 12,800 lb. (5 806 kg)</p> <p>Rear Tandem Axles - Loaded: 36,000 lb. (16 329 kg)</p>
M1120	<p>PERFORMANCE</p> <p>Cruising Range at GCWR: 300 mi. (483 km)</p> <p>Maximum Sustained Forward Speed (at 2100 rpm) - 4th Gear: 57 mph (9 2 kph)</p> <p>Maximum Sustained Forward Speed (at 2100 rpm) - 3th Gear: 41 mph (66 kph)</p>

Table 1-1. Equipment Data (Cont)

Model	Item
M1120 (Cont)	<p>PERFORMANCE (CONT)</p> <p>Maximum Sustained Forward Speed (at 2100 rpm) - 2nd Gear: 28 mph (45 kph)</p> <p>Maximum Sustained Forward Speed (at 2100 rpm) - 1st Gear: 15 mph (24 kph)</p> <p>Speed on 3% Grade at GCWR: 25 mph (40 kph)</p> <p>Speed on 3% Grade at GVWR: 40 mph (64 kph)</p> <p>Speed on 30% Grade at GCWR: 3 mph (5 kph)</p> <p>Speed on 30% Grade at GVWR: 5 mph (8 kph)</p> <p>Maximum Grade at GCWR: 30 percent</p> <p>Maximum Grade at GVWR: 60 percent</p> <p>Maximum Side Slope w/Adequate Traction Surface: 30 percent</p> <p>Maximum Towed Speed (Reference FM 20-22): 15 mph (24 kph)</p> <p>Maximum Ford Depth: 48 in. (1 219 mm)</p> <p>Approach Angle: 41 degrees</p> <p>Departure Angle: 45 degrees</p> <p>Limp Home Speed: 10 mph (16 kph) for up to 30 mi. (48 km)</p>

Introduction (Cont)

Table 1-1. Equipment Data (Cont)

Model	Item
M1120	<p>CAPACITIES</p> <p>Engine Oil w/o Filters: 28 qt. (27 L)</p> <p>Engine Oil w/Filters: 30 qt. (28 L)</p> <p>Cooling System: 80 qt. (76 L)</p> <p>Transmission w/o Filter: 37 qt. (35 L)</p> <p>Transmission w/Filter: 38 qt. (36 L)</p> <p>Front Tandem - Front Axle (No. 1): 17.5 qt. (16.6 L)</p> <p>Front Tandem - Rear Axle (No. 2): 21.5 qt. (20.3 L)</p> <p>Rear Tandem - Front Axle (No. 3): 21 qt. (20 L)</p> <p>Rear Tandem - Rear Axle (No. 4): 16.5 qt. (15.6 L)</p> <p>Hydraulic Reservoir w/Filters: 120 qt. (114 L)</p> <p>Fuel Tank: 154 gal (583 L)</p> <p>Transfer Case: 6.5 qt. (6.2 L)</p> <p>Windshield Washer Fluid: 2 qt. (2 L)</p> <p>Operating Modes: On/off road</p> <p>Operating Temperature w/o Arctic Kit: -25 to 120°F (-32 to 49°C)</p> <p>Operating Temperature w/Arctic Kit: -50 to 120°F (-46 to 49°C)</p>
M1120	<p>ENGINE</p> <p>Make: Detroit Diesel</p> <p>Model: 8V92TA</p> <p>Type: 2-Stroke, V-type Diesel</p> <p>Cylinders: 8</p> <p>Bore: 4.84 in. (123 mm)</p> <p>Stroke: 5 in. (127 mm)</p> <p>Displacement: 736 cid (12 L)</p> <p>Torque (at 2100 rpm): 1250 lb-ft. (1 695 N•m)</p> <p>Maximum Brake Horsepower (at 2100 rpm): SAE445 hp (332 kw)</p> <p>Maximum Governed Engine Speed - Loaded: 2050 - 2150 rpm</p> <p>Maximum Governed Engine Speed - No Load: 2175 - 2275 rpm</p> <p>Oil Filter Type: Full flow, replaceable element</p> <p>Oil Filter Quantity: 1</p>

Introduction (Cont)

1-11. EQUIPMENT DATA (CONT).

Table 1-1. Equipment Data (Cont)

Model	Item
M1120	FUEL SYSTEM Type: Diesel Injection Tank Quantity: 1 Air Cleaner Type: Dry element Element Quantity: (1 primary, 1 secondary)
M1120	COOLING SYSTEM Radiator Working Pressure: 7 psi (48 kPa)
M1120	ELECTRICAL SYSTEM Voltage: 24 Vdc Alternator (amps): 130 (5.8 kWh) RFI Suppression Ability: Yes Number of Batteries: 4 Battery Voltage (each): 12 volts Battery Connection: Series - parallel Battery Capacity (at 20-hour rate): 900 amp Battery Reserve Capacity (each, at 80°F, 27°C): 180 minutes Battery Cold Cranking Amps (each, at 0°F, -18°C): 575 CCA Battery Amp Hours (each, at 20-hour rate): 100 amp
M1120	TRANSMISSION Make: Allison Model: HT740D Type: Automatic Number of Forward Speeds: 4 Number of Reverse Speeds: 1
M1120	TRANSFER CASE Make: Oshkosh Model: 55000 Type: Air operated front tandem disconnect Ratios: 98:1 and 2.66:1
M1120	AXLES Front Tandem Make: Oshkosh

Introduction (Cont)

Table 1-1. Equipment Data (Cont)

Model	Item																								
M1120	<p>AXLES (CONT)</p> <p>Differential Carrier Model Nos.: No. 1 axle-RS480 No. 2 axle-DS480-P</p> <p>Maximum Load Capacity: 30,000 lb. (13 600 kg)</p> <p>Maximum Steering Angle: 32 degrees</p> <p>Rear Tandem</p> <p>Make: Eaton</p> <p>Differential Carrier Model Nos.: No. 3 axle-DS480-P No. 4 axle-RS480</p> <p>Maximum Load Capacity: 36,000 lb. (16 329 kg)</p>																								
M1120	<p>BRAKE SYSTEM</p> <p>Actuation: Air</p> <p>Number of Brake Chambers: 8</p> <p>Pressure Range: 60 - 120 psi (414 - 827 kPa)</p>																								
M1120	<p>WHEELS</p> <p>Type: 2-piece bolt-together</p> <p>Quantity: 8</p> <p>Vehicle Spare Wheel</p> <p>Quantity: 1</p> <p>Rim Size: 20 x 20</p> <p>Stud Quantity Per Wheel: 10</p>																								
M1120	<p>TIRES</p> <p>Type: Radial tubeless</p> <p>Quantity: 8</p> <p>Spare Quantity: 1</p> <p>Tread Type: Radial traction, non-directional</p> <p>Size: 16:00R x 20 in.</p> <p>Load Range: M</p> <p>Tire Pressures:</p> <table border="0" data-bbox="418 1577 1511 1728"> <thead> <tr> <th></th> <th>Highway</th> <th>Cross Country - Dry</th> <th>Cross Country - Wet</th> </tr> </thead> <tbody> <tr> <td>Front</td> <td>60 psi (414 kPa)</td> <td>35 psi (241 kPa)</td> <td>20 psi (138 kPa)</td> </tr> <tr> <td>Rear</td> <td>83 psi (572 kPa)</td> <td>47 psi (324 kPa)</td> <td>37 psi (255 kPa)</td> </tr> <tr> <td>Spare Tire</td> <td>100 psi (689kPa)</td> <td>100 psi (689 kPa)</td> <td>100 psi (689 kPa)</td> </tr> </tbody> </table> <p>Operating Speeds:</p> <table border="0" data-bbox="418 1787 1511 1856"> <thead> <tr> <th></th> <th>Highway</th> <th>Cross Country - Dry</th> <th>Cross Country - Wet</th> </tr> </thead> <tbody> <tr> <td>Maximum Speed</td> <td>55 mph (89 kmh)</td> <td>40 mph (64 kmh)</td> <td>20 mph (32 kmh)</td> </tr> </tbody> </table>		Highway	Cross Country - Dry	Cross Country - Wet	Front	60 psi (414 kPa)	35 psi (241 kPa)	20 psi (138 kPa)	Rear	83 psi (572 kPa)	47 psi (324 kPa)	37 psi (255 kPa)	Spare Tire	100 psi (689kPa)	100 psi (689 kPa)	100 psi (689 kPa)		Highway	Cross Country - Dry	Cross Country - Wet	Maximum Speed	55 mph (89 kmh)	40 mph (64 kmh)	20 mph (32 kmh)
	Highway	Cross Country - Dry	Cross Country - Wet																						
Front	60 psi (414 kPa)	35 psi (241 kPa)	20 psi (138 kPa)																						
Rear	83 psi (572 kPa)	47 psi (324 kPa)	37 psi (255 kPa)																						
Spare Tire	100 psi (689kPa)	100 psi (689 kPa)	100 psi (689 kPa)																						
	Highway	Cross Country - Dry	Cross Country - Wet																						
Maximum Speed	55 mph (89 kmh)	40 mph (64 kmh)	20 mph (32 kmh)																						

Introduction (Cont)

1-11. EQUIPMENT DATA (CONT).

Table 1-1. Equipment Data (Cont)

Model	Item
M1120	<p>STEERING SYSTEM Type: Dual gear with integrated hydraulic power assist</p>
M1120	<p>PINTLE Type: Manual Release - Self-Guided Coupler Maximum Trailer Load Capacity - Pulling: 39,000 lb. (17 690 kg) Maximum Load Capacity - Vertical: 17,000 lb. (7 711 kg)</p>
M1120	<p>TOWING EYES Quantity: 4 (2 front, 2 rear) Maximum Load Capacity Each: 60,000 lb. (27 200 kg)</p>
M1120	<p>CAB Windshield: Tinted, 2-piece, safety glass Personnel Capacity: 2</p>
M1120 with Winch	<p>SELF-RECOVERY WINCH Make: DP Manufacturing Model: 20K-HEMTT</p>
M1120	<p>Wire Rope Diameter: 9/16 in. (14.3 mm) Wire Rope Length: 200 ft. (61 m) Line Pull - 1st Layer (Five Wraps Minimum): 20,000 lb. (9 100 kg) Line Pull - 2nd Layer: 18,173 lb. (8 243 kg) Line Pull - 3rd Layer: 16,663 lb. (7 558 kg) Line Pull - 4th Layer: 15,361 lb. (6 968 kg) Line Pull - 5th Layer: 14,254 lb. (6 466 kg)</p>
M1120	<p>AUXILIARY EQUIPMENT Arctic Kit - Engine Chemical Alarm Decontamination Unit Gas Particulate Filter Unit Machine Gun Ring Radio Installation Kit Rifle Mounting Kit * Vehicle may or may not be equipped with any of these items depending on mission, climate, or other factors.</p>

Introduction (Cont)

Table 1-1. Equipment Data (Cont)

Model	Item
M1120	LOAD HANDLING SYSTEM Make: OTC Model: MKV
M1120 w/CHU	CONTAINER HANDLING UNIT W/FRONT LIFT ADAPTER (FLA) Make: OTC Model: CHU Maximum Capacity: 24,000 lbs. (10 886 kg)

Table 1-2. Load Classification

Model	Unloaded (ton)	Full Load (ton)
M1120	18	28

Section III. Technical Principals of Operation

1-12. SYSTEMS INTRODUCTION.

All M1120 vehicles contain three functional systems. They are the electrical system, air system, and hydraulic system. Refer to TM 9-2320-279-10 for information on these systems.

1-13. LOAD HANDLING SYSTEM (LHS).

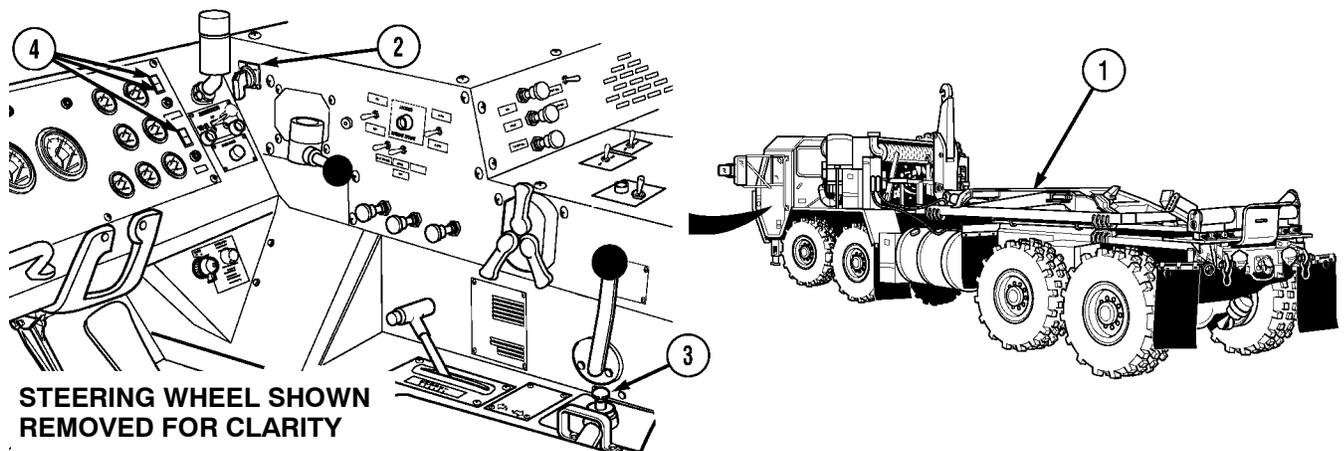

The LHS (1) is fully hydraulic, powered by the truck hydraulic system, and is operated by a hydraulic selector switch (2) and a joystick (3), located to the driver's right in the truck cab. The LHS control system is electrically powered from the truck electrical system. The LHS is capable of the following, with a flatrack (FR) loaded with 11 ton (9 979 kg) nominal payload:

- Loading/unloading the FR from the truck to 12 in. (30.5 cm) below ground level and any intermediate level.

Introduction (Cont)

1-13. LOAD HANDLING SYSTEM (LHS) (CONT).

- Loading/unloading from uneven ground slopes of 5 degrees from the trucks lateral and horizontal axis.
- Loading/unloading to/from trailers or ramps in which the height is equal to or less than the height from the ground to the bottom of the FR (while on the truck).

The LHS with CHU kit is capable of the following, with a flatrack (FR) or container loaded with 24,000 lb (10 886 kg) nominal payload:

- Loading/unloading the FR or container from the truck to 12 in. (30,5 cm) below ground level and any intermediate level.
- Loading/unloading from uneven ground, slopes of 5 degrees from the trucks lateral and horizontal axis.

The LHS is capable of the following, with the FRS:

- Loading/unloading the FRS from the truck to 12 in. (30.5 cm) below ground level and any intermediate level.
- Loading/unloading from uneven ground slopes of 5 degrees from the trucks lateral and horizontal axis.

a. Flatrack Locking. The LHS is designed with automatic locking features that secure the FR for all modes of transportation. The LHS can automatically guide, center, and secure a FR to the truck so that even during rough trail operations, the FR remains safely secured.

b. LHS Overload. The LHS will not function when the payload exceeds 11 tons (9 979 kg) maximum. A warning indicator (4), located in the cab in plain view of the driver, activates when a FR with a payload of 11 tons (9 979 kg) is being loaded by the LHS while under the worst conditions.

c. Hydraulic System. Hydraulic filters are located to provide direct access and to allow removal without damage to the truck. By-passes are furnished where necessary to protect filters during cold temperature operation. All cylinder rods exposed during operation have a hard chromium plating.

d. Slave Hydraulics. Self-sealing, quick-disconnect hydraulic couplings and a hose with appropriate connectors are provided so that one M1120 truck can readily hydraulically power the LHS of another M1120 truck.

Introduction (Cont)

1-14. CONTAINER HANDLING UNIT (CHU).

The CHU utilizes the LHS (1) to load and unload ISO containers and shelters onto the truck (2). The CHU consists of an FLA (3) which is hooked by the LHS and is attached to an ISO container. The rear slider assembly (4) guides the container onto the truck (2).

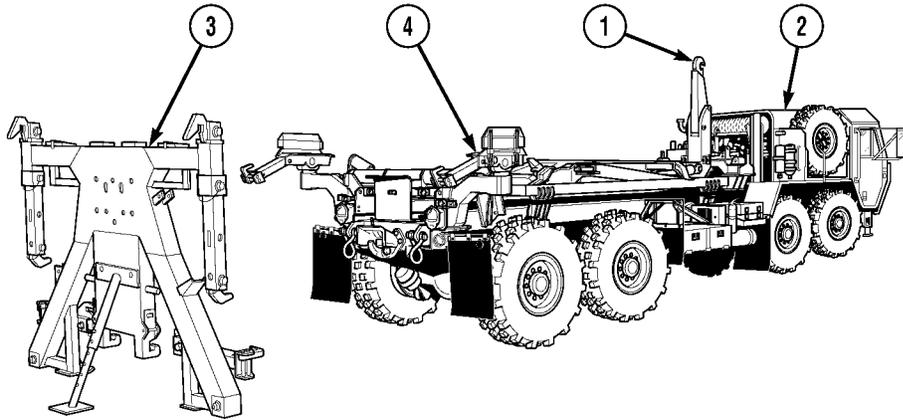

CHAPTER 2 OPERATING INSTRUCTIONS

Contents	Para	Page
Controls and Indicators Introduction	2-1	2-1
Instrument Panel Controls and Indicators	2-2	2-2
PMCS Introduction	2-3	2-4
Maintenance Forms and Records	2-4	2-4
Preventive Maintenance Checks and Services	2-5	2-4
General Maintenance Procedures	2-6	2-5
Leakage Classification and Definition	2-7	2-6
Operator/Crew Preventive Maintenance Checks and Services Tables	2-8	2-6
Load Handling System (LHS)	2-9	2-9
Configuring for Over-the-Road Operations	2-10	2-81
Container Handling Unit (CHU)	2-10.1	2-82
Loading and Unloading Container (82 Inches [208 cm] or Taller) to Truck Using Front Lift Adapter (FLA)	2-10.2	2-82.14
Loading and Unloading Container (72 Inches [183 cm] or Taller) to Truck Using Front Lift Adapter (FLA)	2-10.3	2-82.40
Loading and Unloading Container (51 Inches [130 cm] or Taller) to Truck Using Front Lift Adapter (FLA)	2-10.4	2-82.67
Loading and Unloading Container (48 Inches [122 cm] or Taller) to Truck Using Front Lift Adapter (FLA)	2-10.5	2-82.96
Transport Front Lift Adapter with HEMTT LHS Without Container	2-10.6	2-82.124
Lift Container Out of Mud	2-10.7	2-82.125
Stacking/Loading M3 CROP on Trailer	2-10.8	2-82.134
Loading/Unloading ISO Container with M3 CROP	2-10.9	2-82.136
Rail Transport	2-10.10	2-82.144
Removing and Installing Front Lift Adapter from Truck	2-10.11	2-82.150
Simplified Container Handling Unit (CHU) Operation	2-10.12	2-82.158
Configuring for Air/Sea Transport	2-11	2-82.161
Use Access Ladder	2-12	2-87
Operate Vehicle in Extreme Cold Environment (-26° F [-32° C] to -50° F [-46° C])	2-13	2-89
Emergency Procedures	2-14	2-90

Section I. Description and Use of Operator’s Controls and Indicators

2-1. CONTROLS AND INDICATORS INTRODUCTION.

This section shows the location and describes the use of controls and indicators used to operate the LHS system and Container Handling Unit (CHU) on the M1120.

Operating Instructions (Cont)

2-2. INSTRUMENT PANEL CONTROLS AND INDICATORS.

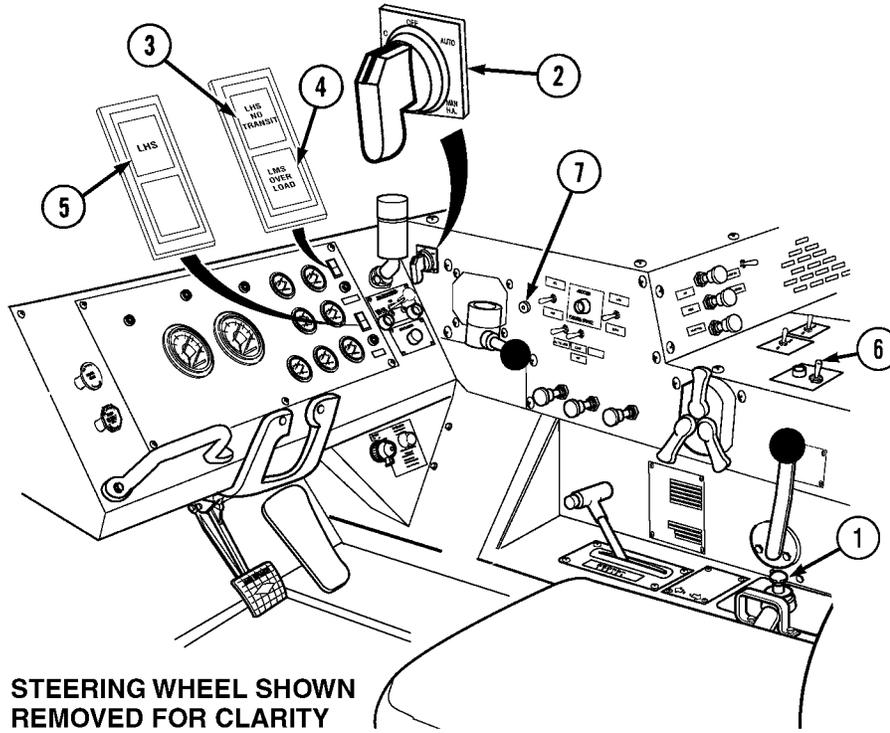

Figure 2-1. LHS Controls and Indicators.

Operating Instructions (Cont)

Legend for Figure 2-1. LHS Controls and Indicators

Key	Control or Indicator	Function
1.	Joystick	Controls operations of loading (LOAD) and unloading (UN-LOAD) of flatracks.
2.	Hydraulic Selector Switch	<p>OFF position: Joystick (1) not operational (LHS transit mode).</p> <p>AUTO position: For normal pick-up and off-loading sequence of flatrack.</p> <p>MANUAL HOOK ARM (MAN H.A.) position: For picking up and off-loading use on trailer, docks, and in event of failure to automatic hook arm electronic circuits.</p> <p>MANUAL MAIN FRAME (MAN M.F.) position: For picking up and offloading on trailers, docks, and in the event of failure of automatic main frame electronic circuits.</p> <p>MANUAL TRANSIT (MAN TRANS) position: Used when automatic circuits have failed and MAN H.A. and MAN M.F. are operated. This position must be selected if truck is to travel.</p> <p>CRANE/SRW position: Not used on this vehicle.</p>
3.	LHS NO TRANSIT Indicator	LHS NO TRANSIT indicator (3) (red): Illuminates when LHS is not correctly stowed in transport position.
4.	LHS OVER LOAD Indicator	LHS OVER LOAD indicator (4) (yellow): Illuminates whenever main hydraulic relief valve is opened during loading or unloading. When light illuminates, driver will be warned that LHS has reached an overload condition or that hydraulic system is lifting very near maximum capacity. OVER LOAD indicator will come on any time main relief valve is cracked open; therefore, load or unload operation may not come to a complete stop, but light will come on momentarily. This situation would indicate that system is lifting near maximum capacity. If the LHS is overloaded, the light illuminates and the system is automatically blocked out. Off-load/on-load flatrack and attempt second operation. If, during this second attempt, the LHS shuts down, stop operation and redistribute weight or reduce payload before attempting load or unload. When attempting to load/unload Forward Repair System (FRS), manual procedures must be followed or LHS overload system will shut down the LHS system (Para 2-9d. and Para 2-9e).
5.	LHS Indicator	LHS indicator (5) (green): Illuminates when rotary hydraulic selector switch (2) is in positions AUTO, MAN H.A., OR MAN M.F.
6.	Power Take Off Switch (PTO)	Supplies or shuts off electrical power to power take off.
7.	Circuit Breaker	Protects LHS electrical system from overload and damage.

Operating Instructions (Cont)

Section II. Operator Preventive Maintenance Checks and Services

2-3. PMCS INTRODUCTION.

This section contains PMCS requirements for the LHS system and CHU on the M1120 series vehicles. The PMCS tables contain checks and services necessary to ensure that the LHS system and CHU are ready for operation. Using PMCS tables, perform maintenance at specified intervals. Refer to TM 9-2320-279-10 for M1120 series vehicle PMCS requirements.

2-4. MAINTENANCE FORMS AND RECORDS.

a. Operator. Every mission begins and ends with paperwork. There is not much of it, but it must be kept up. The filled out forms and records have several uses. They are a permanent record of services, repairs, and modifications made on the vehicle. They are reports to Organizational Maintenance and to your Commander. They are a checklist to know what was wrong with the vehicle after its last use and whether those faults have been fixed. For the information needed on forms and records, refer to DA PAM 738-750.

b. Organizational Maintenance. Department of the Army Forms and Procedures used for maintenance will be those prescribed by DA PAM 738-750, The Arm Maintenance Management System (TAMMS) (Maintenance Management Update).

2-5. PREVENTIVE MAINTENANCE CHECKS AND SERVICES.

a. Do the before (B) PREVENTIVE MAINTENANCE just before operating vehicle. Pay attention to the CAUTIONS and WARNINGS.

b. Do the during (D) PREVENTIVE MAINTENANCE while vehicle and/or its component systems are in operation. Pay attention to the CAUTIONS and WARNINGS.

c. Do the after (A) PREVENTIVE MAINTENANCE right after operating vehicle. Pay attention to the CAUTIONS and WARNINGS.

d. Do the (W) PREVENTIVE MAINTENANCE weekly. Pay attention to the CAUTIONS and WARNINGS.

e. Do the (M) PREVENTIVE MAINTENANCE monthly. Pay attention to the CAUTIONS and WARNINGS.

f. If something does not work, troubleshoot with instructions in Chapter 3 and notify the supervisor.

g. Always do PREVENTIVE MAINTENANCE in the same order until it gets to be habit. Once practiced, problems can be spotted in a hurry.

h. If something looks wrong and cannot be fixed right then, write it on DA Form 2404. If something seems seriously wrong, report it to Organizational Maintenance RIGHT NOW.

i. When doing PREVENTIVE MAINTENANCE, take along the tools needed and a rag or two to make all the checks.

Operating Instructions (Cont)

2-6. GENERAL MAINTENANCE PROCEDURES.**WARNING**

Adhesives, solvents, and sealing compounds can burn easily, can give off harmful vapors, and are harmful to skin and clothing. To avoid injury or death, keep away from open fire and use in well-ventilated area. If adhesive, solvent, or sealing compound gets on skin or clothing, wash immediately with soap and water.

- a. Cleanliness.** Dirt, grease, oil, and debris only get in the way and may cover up a serious problem. Use drycleaning solvent (Appendix F, Item 18) on all metal surfaces.
- b. Bolts, Nuts, and Screws.** Check bolts, nuts, and screws for obvious looseness, missing, bent, or broken condition. Look for chipped paint, bare metal, or rust around boltheads. If any part seems loose, tighten it, or report it to Organizational Maintenance.
- c. Welds.** Look for loose or chipped paint, rust, or gaps where parts are welded together. If a bad weld is found, report it to Organizational Maintenance.
- d. Electric Wires and Connectors.** Look for cracked or broken insulation, bare wires, and loose or broken connectors. Tighten loose connectors and make sure wires are in good condition. If a bad wire or faulty connector is found, report it to Organizational Maintenance.
- e. Hydraulic Lines and Fittings.** Look for wear, damage, and leaks; make sure clamps and fittings are tight. Wet spots show leaks. Stains around a fitting or connector can mean a leak. If a leak comes from a loose fitting or connector, tighten it. If something is broken or worn out, report it to Organizational Maintenance.
- f. Damage is defined as:** Any conditions that affect safety or would render the vehicle unserviceable for mission requirements.

Operating Instructions (Cont)

2-7. LEAKAGE CLASSIFICATION AND DEFINITION.

CAUTION

Equipment operation is allowable with minor leaks (Class I or II). Consideration must be given to the fluid capacity in the item/system being checked/inspected. When in doubt, notify the supervisor. When operating with Class I or II leaks, continue to check fluid levels as required in the PMCS. Class III leaks should be repaired using tools available if possible. If not, use "Not Fully Mission Capable" column criteria.

NOTE

- If leakage is detected, further investigation is needed to determine the location and cause of the leak. If there is any doubt, contact your supervisor or Organizational Maintenance.
- Diesel engine slobber is an inherent condition of two-cycle diesel engines when engines are allowed to idle for prolonged periods of time. This characteristic may be incorrectly interpreted as a Class III leak. Check engine oil level. If there is any doubt, consult with your supervisor or Organizational Maintenance.

a. Class I. Leakage of fluid as indicated by wetness or discoloration not great enough to form drops.

b. Class II. Leakage of fluid great enough to form drops but not enough to cause drops that fall from item being checked/inspected.

c. Class III. Leakage of fluid great enough to form drops that fall from the item being checked/inspected. Try to fix leak using tools available.

2-8. OPERATOR/CREW PREVENTIVE MAINTENANCE CHECKS AND SERVICES TABLES.

NOTE

Table 2-1 covers items common to LHS system and CHU on M1120 series vehicle. Refer to TM 9-2320-279-10 for vehicle PMCS.

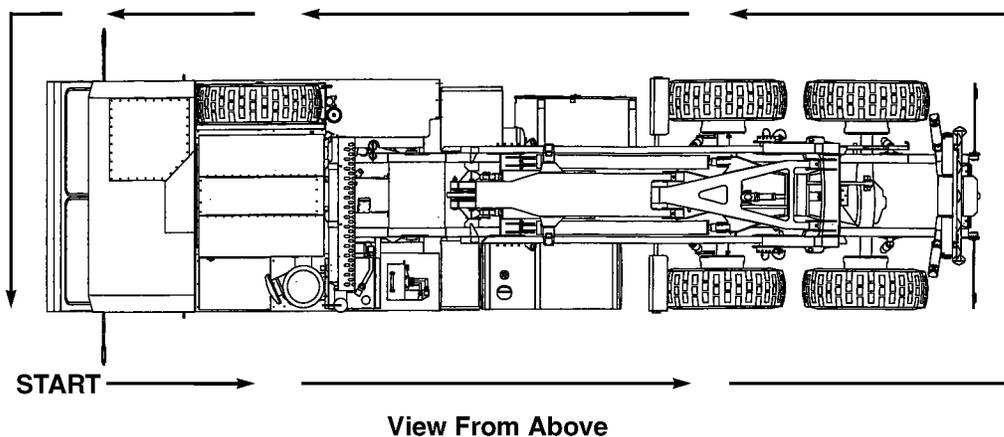

Operating Instructions (Cont)

Table 2-1. Operator's Preventive Maintenance Checks and Services (Before)

Item No.	Interval	Location		Procedure	Not Fully Mission Capable if:
		Item to Check/Service			
1	Before	Load Handling System (LHS) Controls		<p style="text-align: center;">WARNING</p> <p>Check for overhead power lines or other obstructions before attempting LHS operation. LHS reaches a system height of 17 ft. 2 in. (5.23 m) with ISO container. Serious injury or death could result from contact with electrical power lines.</p> <p>(a) Check for proper operation of hydraulic selector switch (1) and joystick control (2). Verify by putting PTO ENGAGE switch (3) in ON position. Make sure indicator light (4) comes on and place hydraulic selector switch (1) in the AUTO position.</p> <p>(b) Pull joystick (2) to rear to raise LHS approximately one to two ft. (0.305 to 0.610 m). LHS indicator (5) will light green and LHS NO TRANSIT indicator (6) will light red. LHS OVER LOAD indicator (7) may light yellow if system is overloaded.</p> <p>(c) Push joystick (2) forward and lower to transport position. LHS NO TRANSIT indicator (6) will go out.</p> <p>(d) Turn hydraulic selector switch (1) to OFF. LHS indicator (5) will go out.</p> <p>(e) Put PTO ENGAGE switch (3) in OFF position. Make sure indicator light (4) goes off.</p> <p>(f) Shut OFF engine (TM 9-2320-279-10).</p>	LHS will not operate.

Operating Instructions (Cont)

2-8. OPERATOR/CREW PREVENTIVE MAINTENANCE CHECKS AND SERVICES TABLES (CONT).

Table 2-2. Operator's Preventive Maintenance Checks and Services (After)

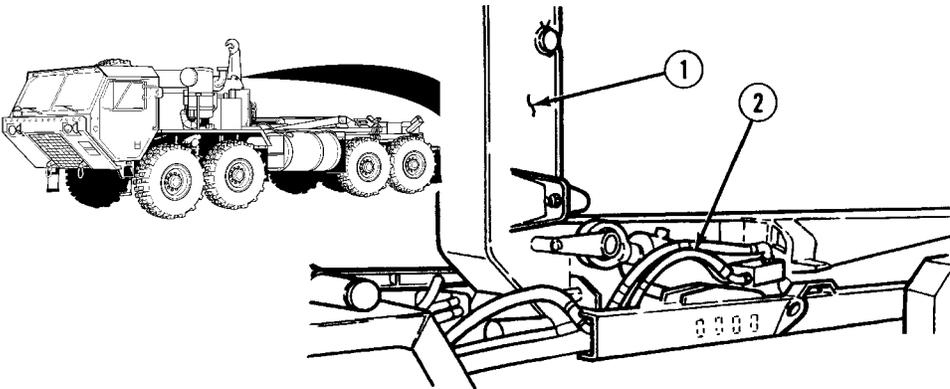
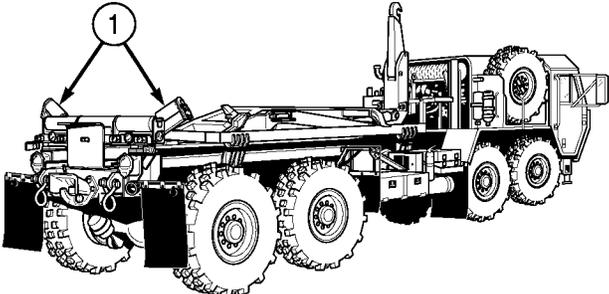
Item No.	Interval	Location	Procedure	Not Fully Mission Capable if:
		Item to Check/ Service		
				
1	After	Load Handling System (LHS)	Check LHS (1) for loose and missing parts.	Parts are missing.
2	After	Load Handling System (LHS)	Visually check hydraulic lines and hoses (2), for leaks. Visually check for cracked and kinked lines.	Class III leak is evident. Cracks or kinks that will impair operation are present.
				
3	After	Load Handling System (LHS) Rollers	Check LHS rollers (1) for damage and binding.	Rollers broken, missing, or inoperable.

Operating Instructions (Cont)

Table 2-3. Operator's Preventive Maintenance Checks and Services for CHU (After)

Item No.	Interval	Location	Procedure	Not Fully Mission Capable if:
		Item to Check/Service		
1	After	Front Lift Adapter (FLA)	<p>(a) Check FLA (1) for missing or damaged lock pin (2). If lock pin (2) is missing or damaged, remove lock pin from rail transport lock for temporary use as replacement.</p> <p>(b) Check container locks (3) for damage and/or free rotation.</p> <p>(c) Check for damaged or missing handle lock (4), handle (5), hand nut (6), or spring (7).</p>	<p>Parts are damaged or missing.</p> <p>Parts are damaged or missing.</p> <p>Parts are damaged or missing.</p>

Operating Instructions (Cont)

2-8. OPERATOR/CREW PREVENTIVE MAINTENANCE CHECKS AND SERVICES TABLES (CONT).

Table 2-3. Operator's Preventive Maintenance Checks and Services for CHU (After) (Cont)

Item No.	Interval	Location	Procedure	Not Fully Mission Capable if:
		Item to Check/Service		
<p>NOTE</p> <p>If hooks are missing or removed to replace lost pins, hook on opposite side must also be removed to maintain balance.</p>				
2	After	Rear Container Locks	<p>(a) Check rear container locks (1) for missing hooks (2).</p> <p>(b) Check for missing or damaged pins (3) and lock pins (4).</p> <p>If pin (3) or parts are damaged or missing, or lock pin (4) is damaged or missing, container guide storage pin (5) may be used temporarily.</p>	<p>Parts are damaged or missing.</p> <p>Parts are damaged or missing.</p>

Operating Instructions (Cont)

Table 2-3. Operator's Preventive Maintenance Checks and Services for CHU (After) (Cont)

Item No.	Interval	Location	Procedure	Not Fully Mission Capable if:
		Item to Check/Service		
<p>NOTE</p> <p>If hooks are missing or removed to replace lost pins, hook on opposite side must also be removed to maintain balance.</p>				
3	After	Hooks	<p>Check standard hooks (1), 6-ft. (183 cm) hooks (2), half-height hooks (3), and hooks (4) for missing or damaged pins (5) and snapper pins (6).</p> <p>If top hook (1) pin (5), or snapper pin (6) is damaged or missing, remove pin (5) and snapper pin (6) from 6-ft. (183 cm) hook (2). Secure top hook with pin and snapper pin, then secure 6-ft. hook in truck.</p> <p>If recovery hook (4) pin (5), or snapper pin (6) is damaged or missing, remove pin (5) and snapper pin (6) from lower end of rail transport strut (7) in stowed location. Pin from slide arm (8) could also be used.</p>	<p>Parts are damaged or missing.</p> <p>Parts are damaged or missing.</p> <p>Parts are damaged or missing.</p>

Operating Instructions (Cont)

2-8. OPERATOR/CREW PREVENTIVE MAINTENANCE CHECKS AND SERVICES TABLES (CONT).

Table 2-3. Operator's Preventive Maintenance Checks and Services for CHU (After) (Cont)

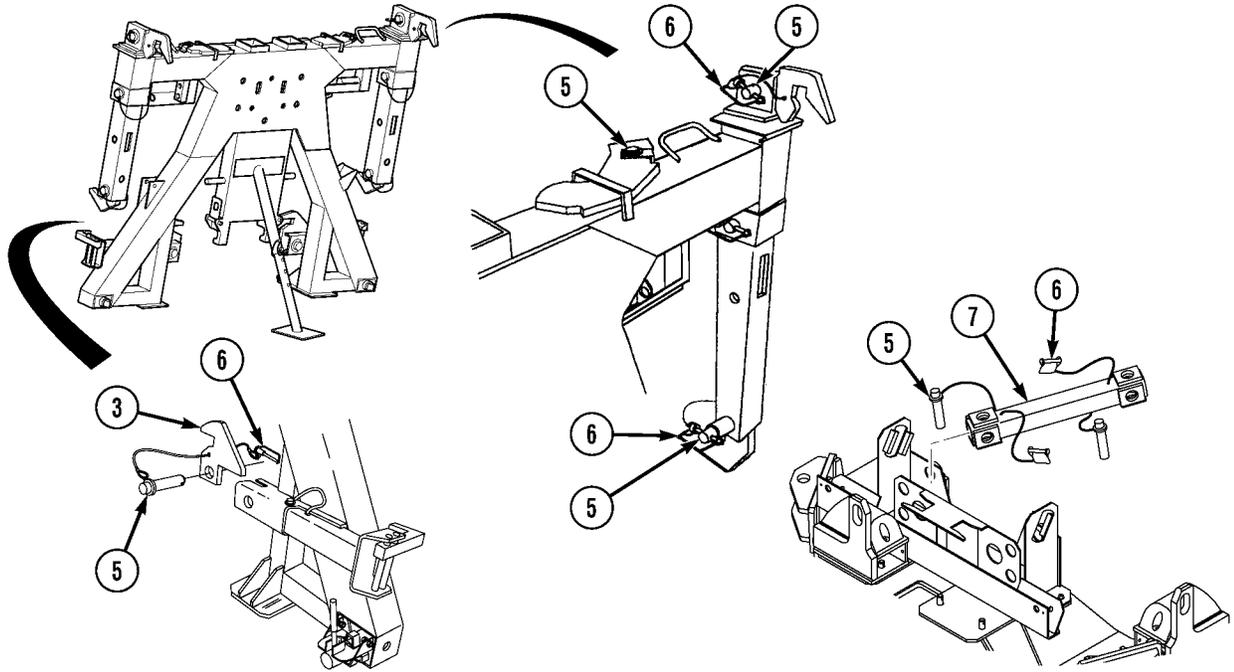
Item No.	Interval	Location	Procedure	Not Fully Mission Capable if:
		Item to Check/Service		
	After	Hooks - (Cont)	 <p>If half-height hook (3), pin (5), or snapper pin (6) is damaged or missing, remove pin (5) and snapper pin (6) from one end of rail transport strut (7) in stowed location. Pin will be slightly longer, but will still function in this location.</p>	Parts are damaged or missing.

Operating Instructions (Cont)

Table 2-3. Operator's Preventive Maintenance Checks and Services for CHU (After) (Cont)

Item No.	Interval	Location	Procedure	Not Fully Mission Capable if:
		Item to Check/Service		
4	After	Bail Bar Lock	<p>Check bail bar lock (1) for missing or damaged pin (2) and lock pin (3) or deformation greater than 3/16 in. (4.76 mm), except handle.</p>	Parts are damaged or missing.
5	After	Slide Arm	<p>(a) If truck is equipped with Container Handling Unit (CHU), make sure slide arm (4) has free movement.</p> <p>(b) Check for missing or damaged pins (5) and lock pins (6).</p> <p>If slide arm (4), pin (5), or snapper pin (6) is damaged or missing, rail transport strut pin (5), and snapper pin (6) can be used.</p>	Parts are damaged or missing.

Operating Instructions (Cont)

Table 2-3. Operator's Preventive Maintenance Checks and Services for CHU (After) (Cont)

Item No.	Interval	Location	Procedure	Not Fully Mission Capable if:
		Item to Check/ Service		
6	After	Rear Sliders, Pivot Lock Pin, and Container Lock Pivot Pin	<p>(a) If truck is equipped with Container Handling Unit (CHU), make sure rear sliders (1) have free rotation.</p> <p>(b) Check slider wear plate (2) for any one gouge deeper than 1/4 in. (6.35 mm) or more than 80% of heat treat (black coating) is worn through to bare metal.</p> <p>(c) Check pivot lock (3) for missing or damaged parts and proper operation.</p> <p>(d) Check container lock pivot pins (4) for damaged parts and proper operation.</p>	<p>Parts are damaged or missing.</p> <p>Parts are damaged.</p> <p>Parts are damaged or missing.</p> <p>Parts are damaged or missing.</p>
7	After	Container Guides	Check container guides (5) for missing or damaged lock pins (6).	Parts are damaged or missing.

Operating Instructions (Cont)

2-8. OPERATOR/CREW PREVENTIVE MAINTENANCE CHECKS AND SERVICES TABLES (CONT).

Table 2-3. Operator's Preventive Maintenance Checks and Services for CHU (After) (Cont)

Item No.	Interval	Location	Procedure	Not Fully Mission Capable if:
		Item to Check/Service		
8	After	Long and Short Strut	<p>(a) If truck is equipped with Container Handling Unit (CHU), ensure long strut (1) and short strut (2) have free rotation.</p> <p>(b) Check for missing or damaged pins (3) and lock pins (4).</p> <p>If pin (3) or lock pin (4) is damaged or missing, temporary replacements may be removed from guide stowage location (in container mode). In flatrack mode, no pin is needed since properly stowed slider will hold long strut (1) in stowed position.</p>	<p>Parts are damaged or missing.</p> <p>Parts are damaged or missing.</p>

Operating Instructions (Cont)

Table 2-3. Operator's Preventive Maintenance Checks and Services for CHU (After) (Cont)

Item No.	Interval	Location	Procedure	Not Fully Mission Capable if:
		Item to Check/Service		
9	After	Rail Container Locks	Check rail container locks (1) for damage and/or free rotation.	Parts are damaged or missing.

Operating Instructions (Cont)

Section III. Operating Instructions

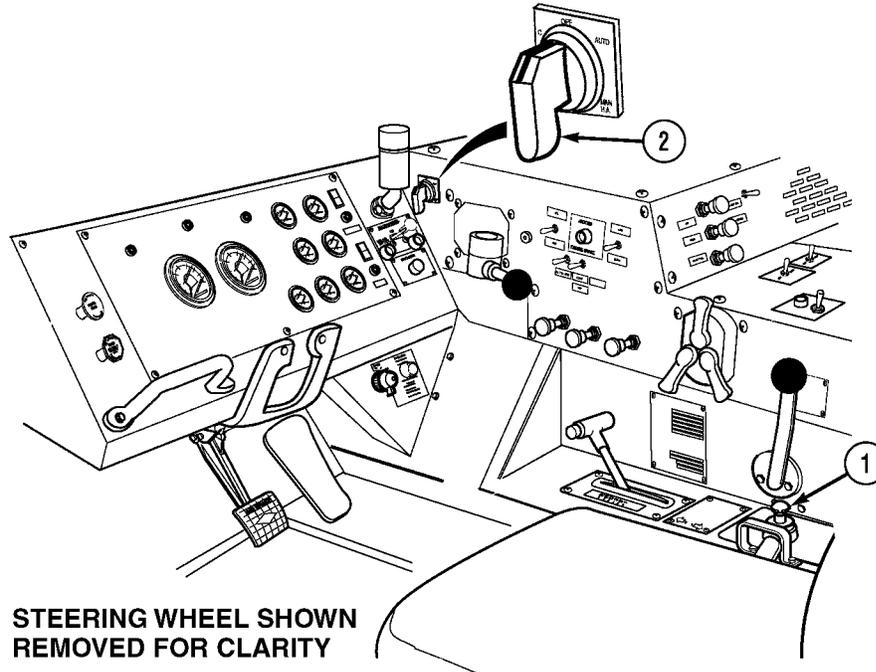
2-9. LOAD HANDLING SYSTEM (LHS).*a. Controls and Indicators.***CAUTION**

- Before starting any LHS operations, clean all operating components of snow, ice, sand, or mud, or damage to equipment may result.
- Before starting any LHS operations, adjust extension mirror to monitor LHS operations, or damage to equipment may result.
- If terrain is deeply rutted, soft soil, etc., mud flaps must be pinned up before beginning LHS operations, or damage to mud flaps may result.
- If LHS had previously been used in Manual mode and not completely stowed in AUTO mode, the hook arm cylinders must be completely extended or the LHS must be completely stowed using Auto mode before the flatrack can be loaded. Failure to comply may result in damage to the truck and flatrack.

- (1) Joystick (1) controls operations of loading (LOAD) and unloading (UNLOAD) of flatracks.
 (2) Hydraulic selector switch (2).

CAUTION

Engine speed must be at idle before using hydraulic selector switch, or damage to equipment may result.

- (a) OFF position: Joystick (1) not operational (LHS transit mode).

Operating Instructions (Cont)

2-9. LOAD HANDLING SYSTEM (LHS) (CONT).

- (b) AUTO position: For normal pick-up and off-loading sequence of flatrack.
 - (c) MANUAL HOOK ARM (MAN H.A.) position: For picking up and off-loading use on trailers, docks, and in event of failure of automatic hook arm electronic circuits.
 - (d) MANUAL MAIN FRAME (MAN M.F.) position: For picking up and off-loading on trailers, docks, and in the event of failure of automatic main frame electronic circuits.
 - (e) MANUAL TRANSIT (MAN TRANS) position: Used when automatic circuits have failed and MAN H.A. and MAN M.F. are operated. This position must be selected if truck is to travel.
 - (f) CRANE/SRW position: Not used.
- (3) Warning Indicators.

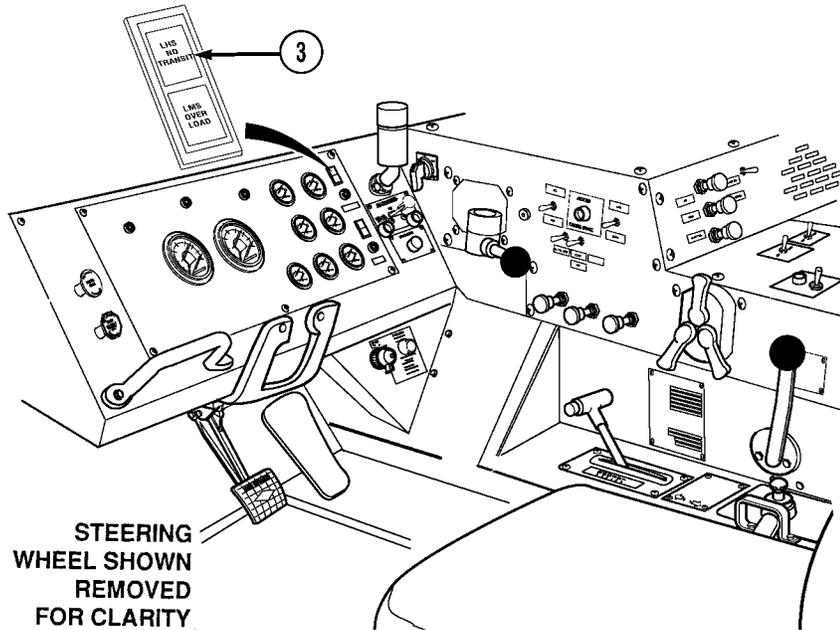

- (g) LHS NO TRANSIT indicator (3) (red) illuminates when LHS is not correctly stowed in transport position.

Operating Instructions (Cont)

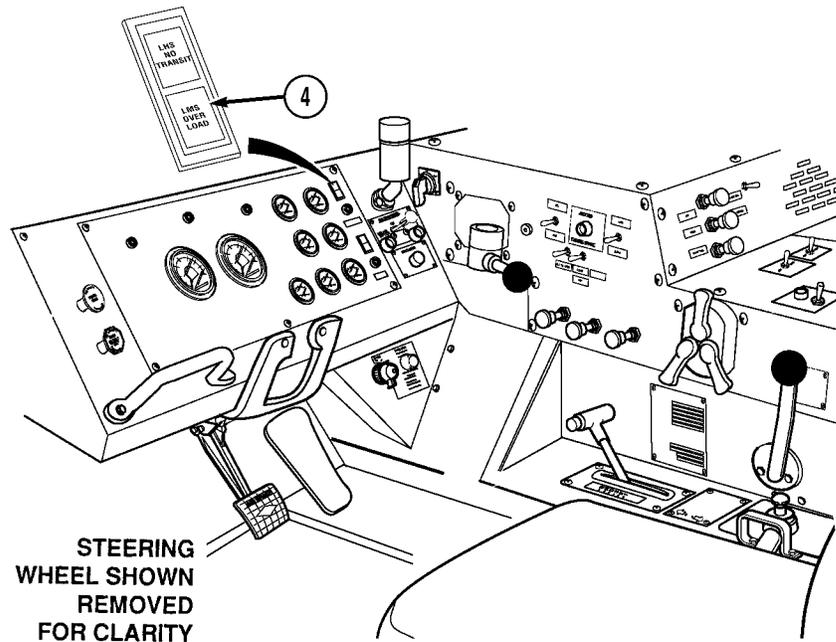
**NOTE**

- To reset LHS overload, return load to start position and release joystick switch.
 - When attempting to load/unload Forward Repair System (FRS), manual-mode procedures must be followed, or LHS overload system will shut down the LHS system (Para 2-9d and Para 2-9e).
- (h) LHS OVER LOAD indicator (4) (yellow) is located on the driver's dash panel and illuminates whenever main hydraulic relief valve is opened during loading or unloading. When indicator illuminates, driver will be warned that LHS has reached an overload condition or that hydraulic system is lifting very near maximum capacity. LHS OVER LOAD indicator will come on any time main relief valve is cracked open; therefore, load or unload operation may not come to a complete stop, but indicator will come on momentarily. This situation would indicate that system is lifting near maximum capacity. If the LHS is overloaded, the LHS OVER LOAD indicator illuminates and the system is automatically blocked out. Off-load/on-load flatrack and attempt second operation. If during this second attempt the LHS shuts down, stop operation and redistribute weight or reduce payload before attempting load or unload.

Operating Instructions (Cont)

2-9. LOAD HANDLING SYSTEM (LHS) (CONT).

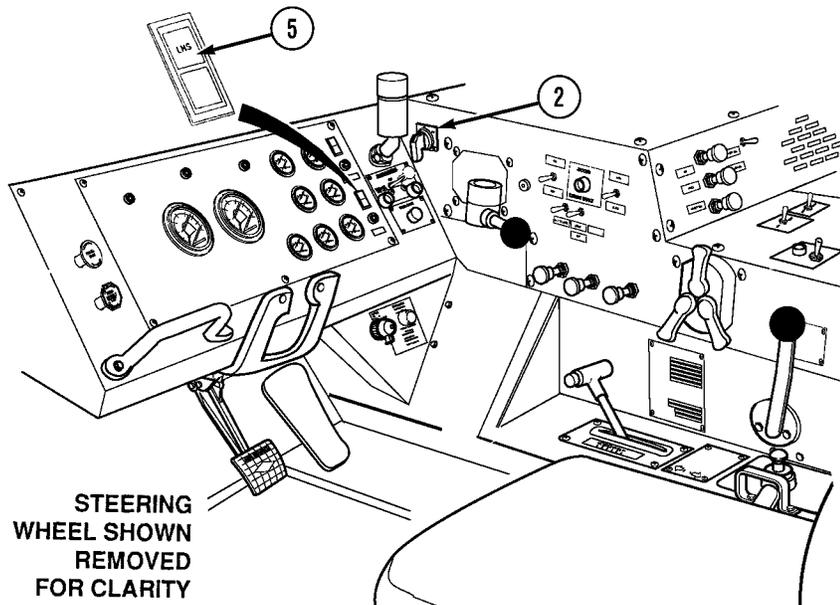

CAUTION

- Overload protection system on M1120 protects LHS and flatrack from structural damage during loading or unloading. This system does not protect truck chassis from being overloaded by means of a crane, forklift, or excessively loaded flatracks.
 - HEMTT LHS Truck chassis is designed to carry an evenly distributed 26,000 lbs. (11 793 kg) payload and flatrack combined weight. Operator is responsible to know what payload weighs.
 - HEMTT LHS with CHU Kit is designed to carry an evenly distributed 24,000 lbs. (10 886 kg) payload and container/flatrack combined weight. Operator is responsible to know what payload weighs.
- (i) LHS indicator (5) (green): Illuminates when rotary hydraulic selector switch (2) is in positions AUTO, MAN H.A., or MAN M.F.

Operating Instructions (Cont)

b. Picking Up a Flatrack in Auto Mode.

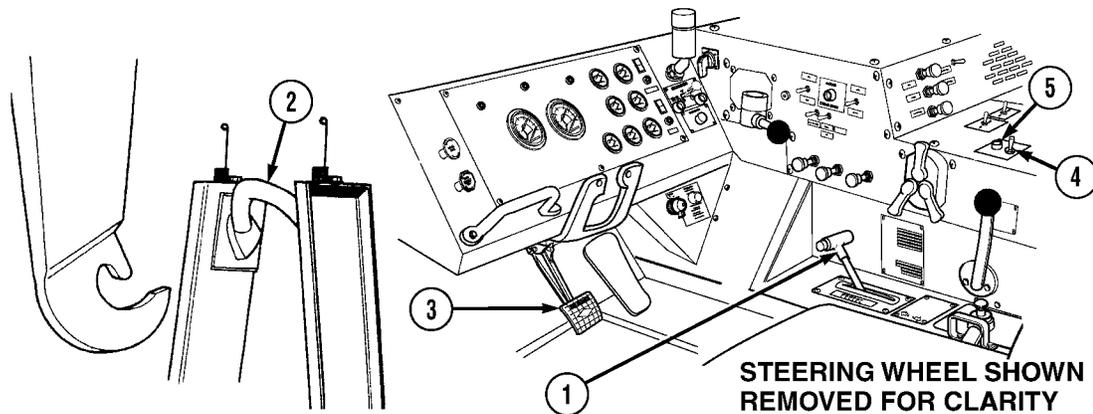

CAUTION

If LHS had previously been used in Manual mode and not completely stowed in Auto mode, the hook arm cylinders must be completely extended or the LHS must be completely stowed using Auto Mode before the flatrack can be loaded. Failure to comply may result in damage to the truck and flatrack.

NOTE

- Continued repetitive cycles, approximately nine at rated 26,000 lb. (11 793 kg) payload, of the load handling system (LHS) could cause overheating and system will fail to pick up the load. Allow the hydraulic system to cool. Wait approximately 1 1/2 hours or until the hydraulic reservoir is cool. The hydraulic reservoir is cool when you can hold your hand on the reservoir for more than 10 seconds.
- Continued repetitive cycles, approximately nine at rated 24,000 lb. (10 886 kg) payload, of the load handling system with container handling unit (CHU) could cause overheating and system will fail to pick up the load. Allow the hydraulic system to cool. Wait approximately 1 1/2 hours or until the hydraulic reservoir is cool. The hydraulic reservoir is cool when you can hold your hand on the reservoir for more than 10 seconds.

(1) Start truck (TM 9-2320-279-10).

NOTE

- The amount of time to load and unload is controlled by engine speed. Engine speed can be increased to 1,500 to maximum rpm to reduce loading and unloading times.
 - LHS will only operate when transmission range selector is in N (Neutral).
- (2) Set transmission range selector (1) to R (Reverse) and back truck up to flatrack. Stop at approximately 5 ft. (1.3 m) from hook bar (2). Check for overhead obstructions and firmness of the ground.
- (3) Apply service brake pedal (3) and set transmission range selector (1) to N (Neutral).
- (4) Put PTO ENGAGE switch (4) in ON position. Make sure indicator light (5) comes on.

Operating Instructions (Cont)

2-9. LOAD HANDLING SYSTEM (LHS) (CONT).

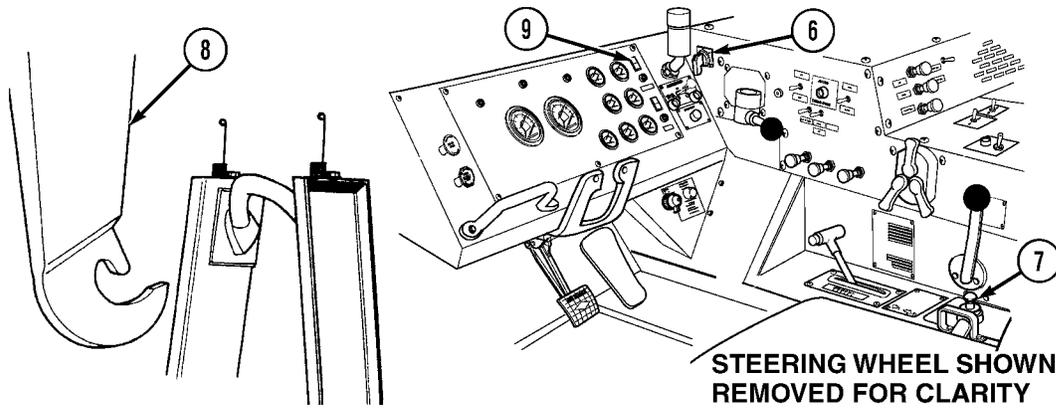

WARNING

- Check for overhead power lines or other obstructions before attempting LHS operation. LHS reaches a height of 17 ft. 2 in. (5.23 m) with ISO container. Serious injury or death to personnel could result from contact with electrical power lines.
- Check ground conditions for firmness and extreme sideways inclination before picking up or off-loading a flatrack. Any ground instability beneath road wheels could cause serious injury or death to personnel.
- Prior to and during any load or unload cycle, all personnel should stay clear of LHS and flatrack or serious injury or death to personnel could result.

CAUTION

Engine speed must be at idle before using hydraulic selector switch, or damage to equipment may result.

- (5) Turn hydraulic selector switch (6) to AUTO position.
- (6) Move joystick (7) to UNLOAD position. Lift hook (8) will raise and begin to move rearwards. LHS NO TRANSIT indicator (9) will illuminate to indicate hook arm is up and load lock has been cleared.

Operating Instructions (Cont)

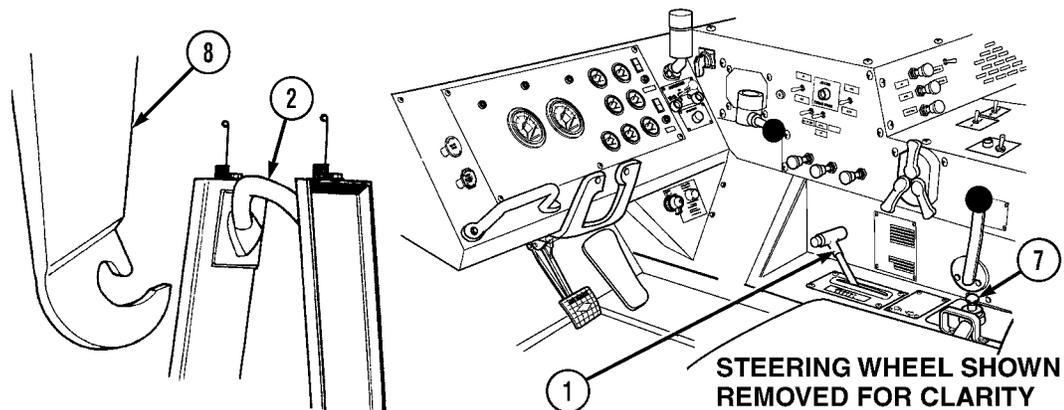
**NOTE**

- To fully view lift hook relation to hook bar, it may be necessary to observe position from outside the cab.
- LHS will only operate when transmission range selector is in N (Neutral).

- (7) Continue to unload until lift hook (8) has moved to below level of flatrack hook bar (2).
 (8) Release joystick (7).
 (9) Set the transmission range selector (1) to R (Reverse) and back truck up to flatrack, alining truck and flatrack as straight as possible with lift hook (8) to middle of hook bar (2) until lift hook (8) contacts hook bar (2). Be sure lift hook tip is positioned below bottom of hook bar (2).

NOTE

LHS will only operate when transmission range selector is in N (Neutral).

- (10) Set the transmission range selector (1) to N (Neutral).

CAUTION

Do not use R (Reverse) to back up truck while hook arm is attached to flatrack or damage to LHS will occur.

- (11) Move the joystick (7) to LOAD position to raise lift hook (8) and engage hook bar (2).

Operating Instructions (Cont)

2-9. LOAD HANDLING SYSTEM (LHS) (CONT).

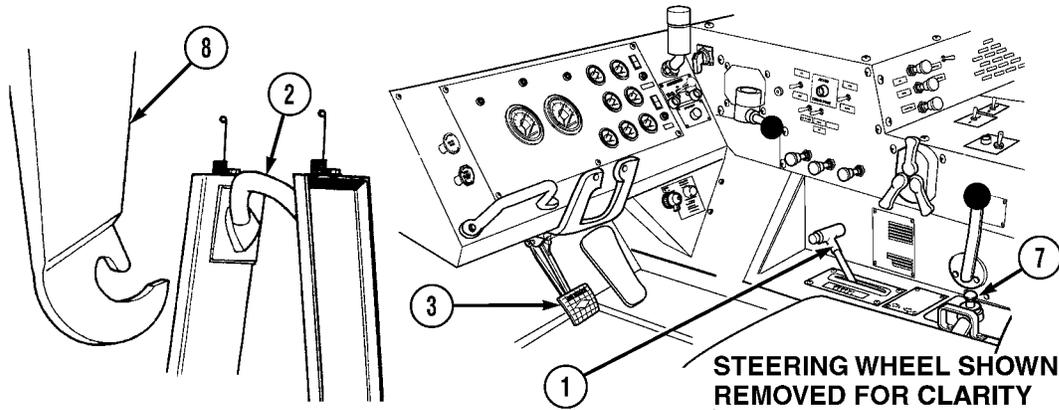

NOTE

LHS will only operate when transmission range selector is in N (Neutral).

- (12) If lift hook (8) fails to engage the hook bar (2):
 - (a) Release the joystick (7).
 - (b) Set the transmission range selector (1) to D (Drive), release service brake pedal (3) and move truck forward to clear flatrack.
 - (c) Move the joystick (7) to UNLOAD position until lift hook (8) is below level of hook bar (2).
 - (d) Repeat steps (7) through (11).
- (13) When correctly engaged, set the transmission range selector (1) to N (Neutral) and release service brake pedal (3).

Operating Instructions (Cont)

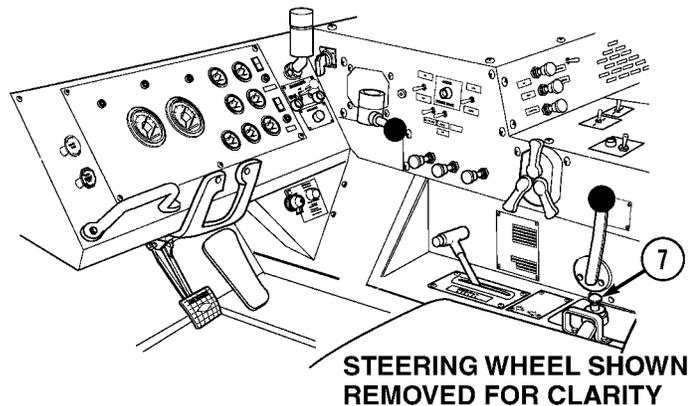

WARNING

When loading or unloading flatracks on uneven ground (side slope or downgrades up to 5 degrees), it may be necessary to apply truck service brakes to prevent truck rollaway or severe injury or death to personnel could result.

CAUTION

- If LHS OVER LOAD indicator illuminates but loading operation continues, operator is cautioned that LHS is nearing maximum capacity. In this situation operator should determine if payload is evenly distributed on flatrack or if flatrack load exceeds 25,000 lbs. (11 340 kg) for LHS or 24,000 lb. (10 886 kg) for LHS with CHU kit. If any of these conditions exist, operator must redistribute or reduce the payload or damage to equipment may occur.
- Load must be evenly distributed on the pallet. Uneven load distribution may cause LHS OVER LOAD indicator to give false signals and cause LHS to operate incorrectly. Damage to equipment may result.
- If LHS OVER LOAD indicator illuminates and normal operation has stopped, return load to original position and redistribute or reduce payload weight or equipment damage may occur.
- Ensure that parking brake is not applied before starting load sequence or damage to equipment may occur.

(14) Move joystick (7) to LOAD position, allowing truck to be pulled under flatrack.

Operating Instructions (Cont)

2-9. LOAD HANDLING SYSTEM (LHS) (CONT).

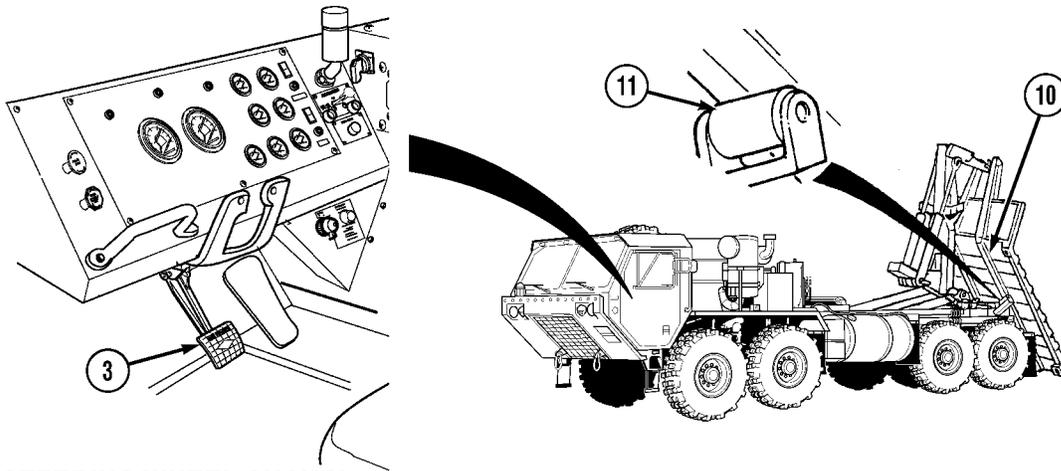

**STEERING WHEEL SHOWN
REMOVED FOR CLARITY**

WARNING

Ensure that flatrack runners contact LHS rear rollers correctly. Failure to contact flatrack runners correctly could result in serious injury or death to personnel and damage to equipment.

NOTE

LHS OVER LOAD indicator may illuminate when lifting flatrack from unusual conditions.

- (15) As load is lifted, truck will be pulled under flatrack. Some steering wheel adjustment may have to be made to ensure that flatrack runners (10) will contact rear rollers (11).

CAUTION

Reduce engine speed to idle before flatrack main rails contact rear rollers or damage to flatrack may result.

- (16) Before flatrack contacts rear rollers (10), reduce engine speed.
(17) Apply service brake pedal (3) after flatrack main rails contact rear rollers.

Operating Instructions (Cont)

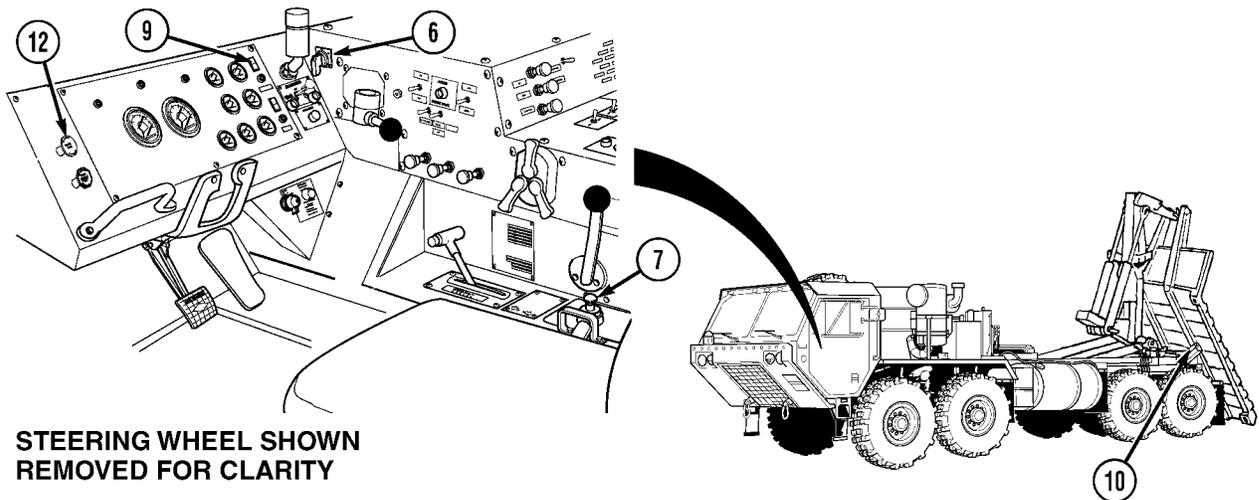

**STEERING WHEEL SHOWN
REMOVED FOR CLARITY**

NOTE

If flatrack is being loaded in soft soil conditions, do steps (a) through (c), then continue with step (18).

- (a) Release joystick (7). Set hydraulic selector switch (6) to MAN H.A. position.
- (b) Move joystick (7) to LOAD position until flatrack is approximately 2 ft. (0.61 m) off the ground. Release joystick.
- (c) Set hydraulic selector switch (6) to AUTO position. Resume normal AUTO operations.

NOTE

Engine speed will require increasing and decreasing in the following steps to facilitate performance.

- (18) After flatrack contacts rear rollers (10), increase engine speed to 1,500 to maximum rpm until flatrack is nearly loaded. Reduce engine speed to idle.
- (19) Continue loading until engaged flatrack is fully loaded and LHS NO TRANSIT indicator (9) goes off.
- (20) Release joystick (7).
- (21) Pull out PARKING BRAKE control (12).

Operating Instructions (Cont)

2-9. LOAD HANDLING SYSTEM (LHS) (CONT).

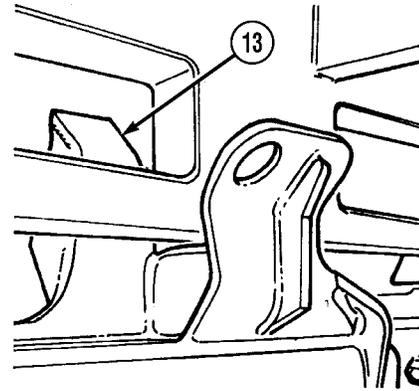
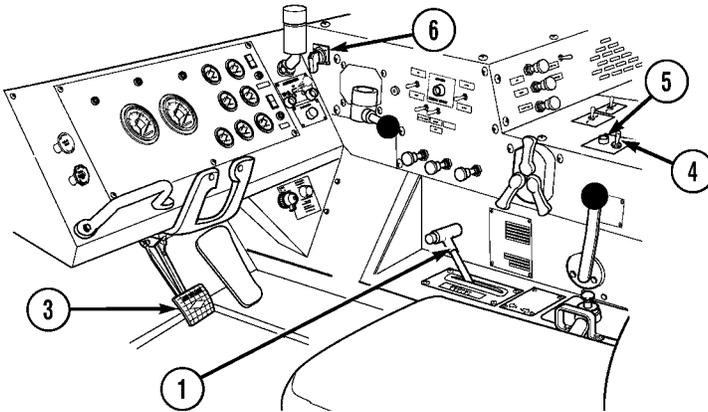

**STEERING WHEEL SHOWN
REMOVED FOR CLARITY**

NOTE

If flatrack is not engaged in load locks, raise flatrack slightly and lower again. Flatrack should set completely and engage load locks.

- (22) Inspect that both load locks (13) have engaged and flatrack is completely down on truck.

CAUTION

Engine speed must be at idle before using hydraulic selector switch, or damage to equipment may result.

- (23) Put PTO ENGAGE switch (4) in OFF position. Make sure indicator light (5) goes off.
 (24) Turn hydraulic selector switch (6) to OFF position.

WARNING

- When loaded with FRS, or container the center of gravity is moved up and toward rear of truck. Extreme caution must be taken when turning and ascending or descending on a grade. Failure to use extreme caution could result in severe injury or death to personnel.
- Maximum side slope when loaded with a FRS or container is 30 percent. Failure to comply may result in equipment damage or severe injury or death to personnel.
- Do not reduce tire pressure when loaded with FRS or container. Highway tire pressure, 60 psi (414 kPa) front and 83 psi (572 kPa) rear, is required at all times when loaded with FRS or container. Failure to comply could result in damage to equipment and severe injury or death to personnel.

Operating Instructions (Cont)

c. Off-Loading Flatrack in Auto Mode.

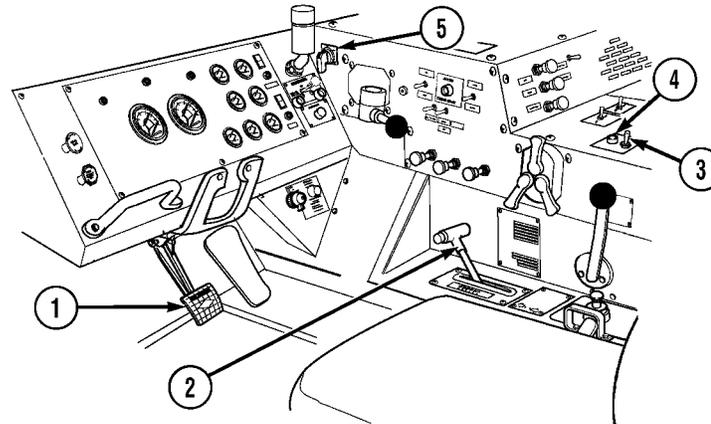

**STEERING WHEEL SHOWN
REMOVED FOR CLARITY**

NOTE

Continued repetitive cycles, approximately nine at rated 26,000 lb. payload, of the load handling system (LHS) could cause overheating and system will fail to pick up the load. Allow the hydraulic system to cool. Wait approximately 1 1/2 hours or until the hydraulic reservoir is cool. The hydraulic reservoir is cool when you can hold your hand on the reservoir for more than 10 seconds.

- (1) Check area for sufficient operating room at front and rear of truck. Check overhead clearance and ground conditions.
- (2) Apply service brake pedal (1) and set transmission range selector (2) to N (Neutral).

CAUTION

Ensure parking brake is not applied during unload sequence or damage to equipment may result.

- (3) Put PTO ENGAGE switch (3) in ON position. Make sure indicator light (4) comes on.
- (4) Set hydraulic selector switch (5) to AUTO position.

Operating Instructions (Cont)

2-9. LOAD HANDLING SYSTEM (LHS) (CONT).

WARNING

- When loading or unloading flatracks on uneven ground (side slope or downgrades up to 5 degrees), it may be necessary to apply truck service brakes to prevent truck rollaway or severe injury or death to personnel could result.
- Check for overhead power lines or other obstructions before attempting LHS operation. LHS reaches a height of 17 ft. 2 in. (5.23 m) with ISO container. Serious injury or death to personnel could result from contact with electrical power lines.
- Check ground conditions for firmness and extreme sideways inclination before picking up or off-loading a flatrack. Any ground instability beneath road wheels could cause serious injury or death to personnel.
- Prior to and during any load or unload cycle, all personnel should stay clear of LHS and flatrack or serious injury or death to personnel could result .

CAUTION

- Check that ground conditions where flatrack will be placed can support the flatrack weight or damage to flatrack or LHS may result.
- Ensure rail transport locking pins are disengaged before unloading flatrack. Rail transport locking pins are used for rail transport only. Failure to comply may result in damage to equipment.

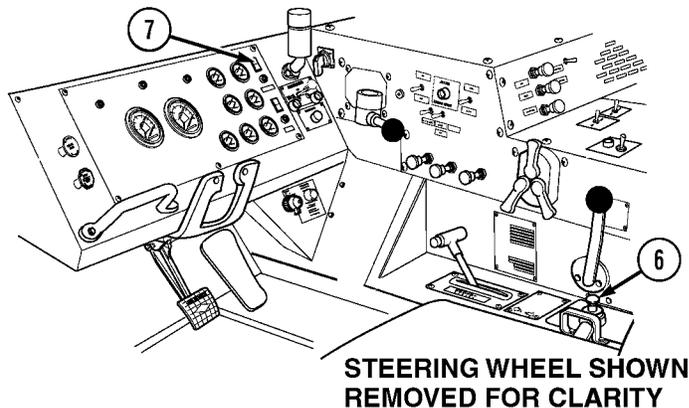

NOTE

LHS OVER LOAD indicator may come on when engine is at idle speed.

- (5) Move joystick (6) to UNLOAD position. Flatrack will start to move rearwards. LHS NO TRANSIT indicator (7) will illuminate. Maintain engine speed at idle until front of flatrack raises approximately 1 ft. (30.5 cm).

NOTE

Loading and unloading times are controlled by engine speed. Engine speed can be increased to 1,500 to maximum rpm to reduce loading and unloading times.

- (6) Continue to unload until rear suspension starts to lift and back edge of flatrack touches ground.

Operating Instructions (Cont)

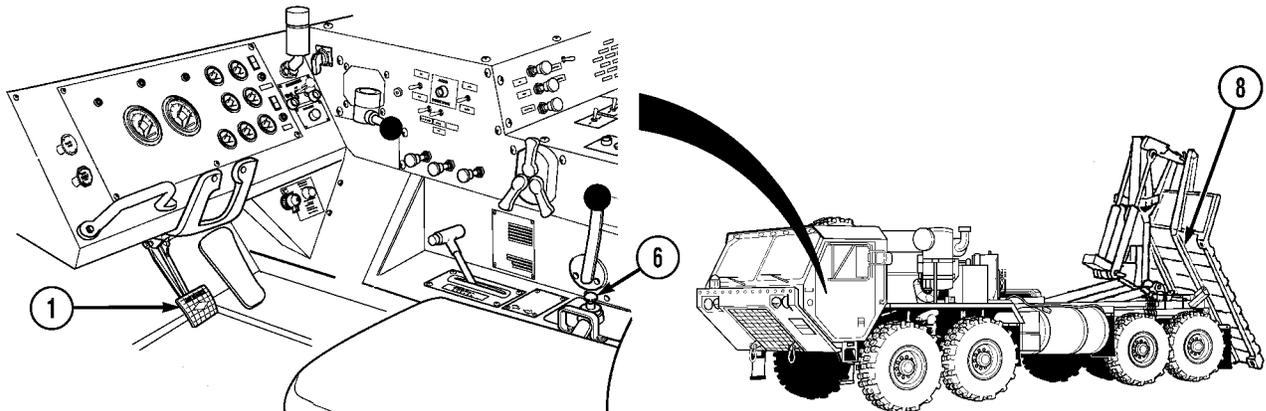

**STEERING WHEEL SHOWN
REMOVED FOR CLARITY**

- (7) Release service brake pedal (1) and allow grounded flatrack to push the truck straight forward from under flatrack and clear.
- (8) As front of flatrack approaches within approximately 8 in. (20.32 cm) of ground, decrease engine speed to idle and apply service brake pedal (1).

CAUTION

Once truck's rear suspension has been relieved of flatrack load, do not continue in UNLOAD position as possibility of jacking up rear of truck with hook arm may occur and damage to equipment may result.

NOTE

If flatrack is extremely light or empty, it may be necessary to place transmission range selector to D (Drive) to allow truck to move out from under flatrack.

- (9) Continue off-loading until flatrack runners (8) are on ground and rear suspension is unloaded.
- (10) Release joystick (6) when flatrack runners (8) are resting on ground.

Operating Instructions (Cont)

2-9. LOAD HANDLING SYSTEM (LHS) (CONT).

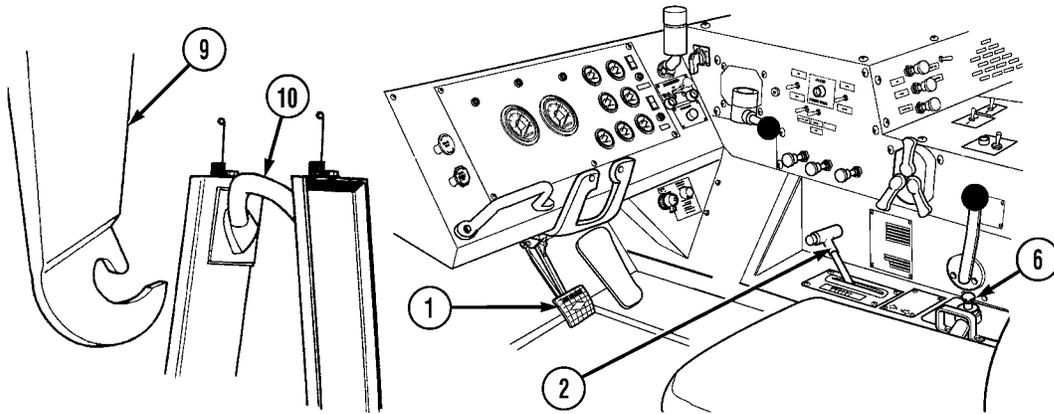

**STEERING WHEEL SHOWN
REMOVED FOR CLARITY**

CAUTION

Do not use R (Reverse) to back up truck while hook arm is attached to flatrack or damage to LHS will occur.

NOTE

- Engine speed should be set at idle. However, slight increase in engine speed may be necessary depending on terrain.
- LHS will only operate when transmission range selector is in N (Neutral).

- (11) Set transmission range selector (2) to D (Drive) and release service brake pedal (1).
- (12) Set transmission range selector (2) to N (Neutral).
- (13) Move joystick (6) to LOAD position momentarily and then to UNLOAD position to let lift hook (9) disengage from hook bar (10). Repeat step (11) until hook disengages.
- (14) Set transmission range selector (2) to D (Drive) and move truck forward approximately 5 ft. (1.5 m).
- (15) Stop truck and set transmission range selector (2) to N (Neutral).

Operating Instructions (Cont)

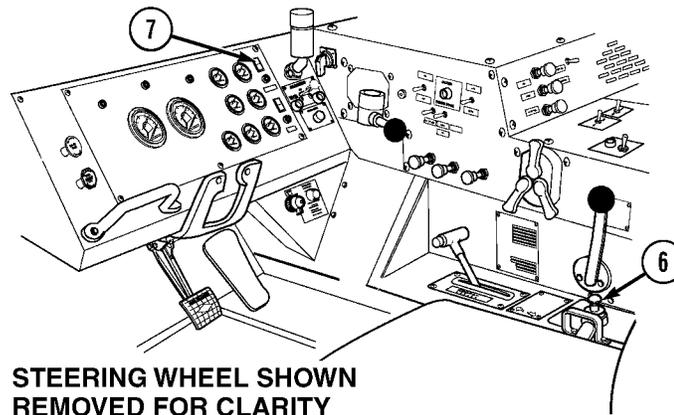

CAUTION

Never drive with LHS NO TRANSIT indicator illuminated. An illuminated indicator means load locks are not engaged and LHS is not fully stowed.

NOTE

Hook arm does not need to be fully stowed if more transfer operations are going to be made.

- (16) Move joystick (6) to LOAD position until LHS is in transit position. LHS NO TRANSIT indicator (7) will go out indicating LHS is in transport position.

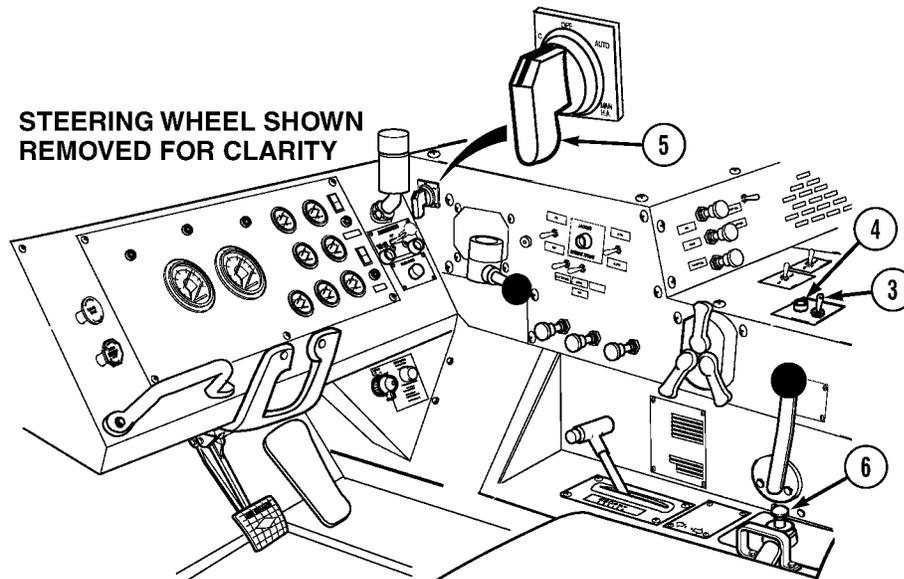

CAUTION

Engine speed must be at idle before using hydraulic selector switch, or damage to equipment may result.

- (17) Release joystick (6).
- (18) Turn hydraulic selector switch (5) to OFF position.
- (19) Put PTO ENGAGE switch (3) in OFF position. Make sure indicator light (4) goes off.

Operating Instructions (Cont)

2-9. LOAD HANDLING SYSTEM (LHS) (CONT).

d. Picking Up a Flatrack/Forward Repair System in Manual Mode.

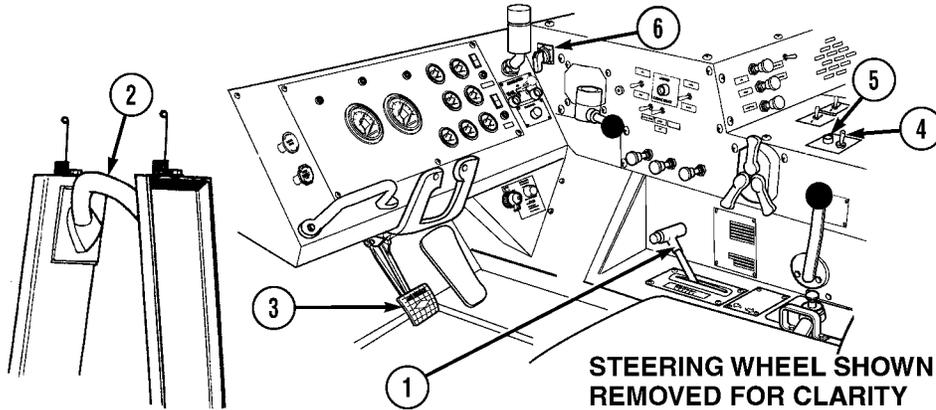

NOTE

LHS will only operate when transmission range selector is in N (Neutral).

- (1) Set transmission range selector (1) to R (Reverse) and back truck up to the flatrack. Stop approximately 5 ft. (1.5 m) from hook bar (2). Check for overhead obstructions and firmness of ground.
- (2) Apply service brake pedal (3) and set transmission range selector (1) to N (Neutral).

CAUTION

- To avoid equipment damage, ensure that hook arm cylinders do not complete full extension while operating at engine speeds above idle.
- Manual mode is used mainly in event of a failure of automatic control electrical system and when loading FRS. Greater care must be exercised during operation of MANUAL mode for correct cycle of events to occur, or damage to equipment may result.

- (3) Put PTO ENGAGE switch (4) in ON position. Make sure indicator light (5) comes on.
- (4) Turn hydraulic selector switch (6) to MAN H.A. position.

Operating Instructions (Cont)

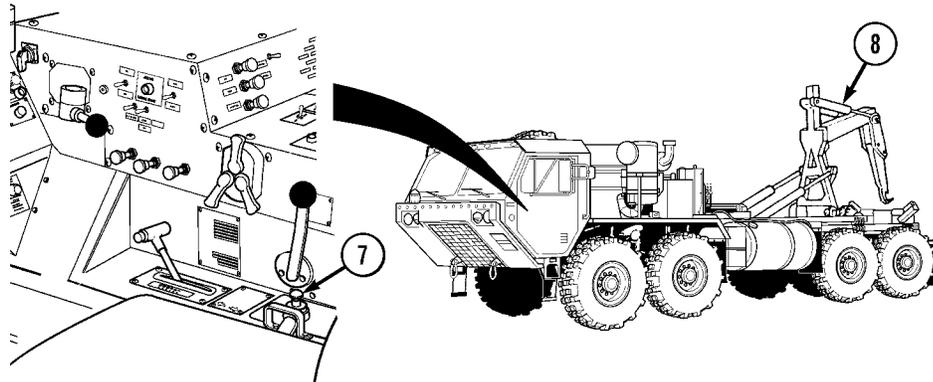

WARNING

- Check for overhead power lines or other obstructions before attempting LHS operation. LHS reaches a height of 17 ft. 2 in. (5.23 m) with ISO container. Serious injury or death to personnel could result from contact with electrical power lines.
- Check ground conditions for firmness and extreme sideways inclination before picking up or off-loading a flatrack. Any ground instability beneath road wheels could cause serious injury or death to personnel.
- Prior to and during any load or unload cycle, all personnel should stay clear of LHS and flatrack or serious injury or death to personnel could result.

NOTE

- LHS OVER LOAD indicator will come on when hook arm cylinders are fully extended and joystick is activated.
- Loading and unloading times are controlled by engine speed. Engine speed can be increased to 1,500 to maximum rpm to reduce loading and unloading times.

- (5) Move joystick (7) to UNLOAD position and hold until hook arm cylinders (8) are fully extended.
 (6) Release joystick (7).

Operating Instructions (Cont)

2-9. LOAD HANDLING SYSTEM (LHS) (CONT).

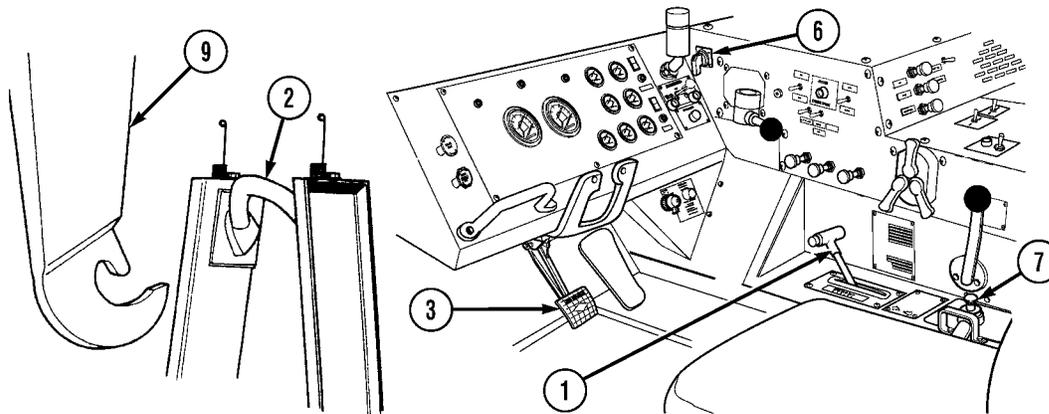

**STEERING WHEEL SHOWN
REMOVED FOR CLARITY**

CAUTION

- Engine speed must be at idle before using hydraulic selector switch, or damage to equipment may result.
- To avoid equipment damage, ensure that main frame cylinders do not complete full extension while operating at engine speeds above idle.
- Manual mode is used mainly in event of a failure of automatic control electrical system. Greater care must be exercised during operation of MANUAL mode for correct cycle of events to occur or damage to equipment may result.
- If LHS had previously been used in manual mode and not completely stowed in AUTO mode, the hook arm cylinders must be completely extended or the LHS must be completely stowed using AUTO mode before the flatrack can be loaded. Failure to comply may result in damage to the truck and flatrack.

NOTE

LHS will only operate when transmission range selector is in N (Neutral).

- (7) Turn hydraulic selector switch (6) to MAN M.F. position.
- (8) Move joystick (7) to UNLOAD position and hold until lift hook (9) has moved below level of flatrack hook bar (2).
- (9) Apply service brake pedal (3) and set transmission range selector (1) to R (Reverse). Back truck up to flatrack/FRS, aligning truck and flatrack/FRS as straight as possible with lift hook (9) to middle of hook bar (2).

Operating Instructions (Cont)

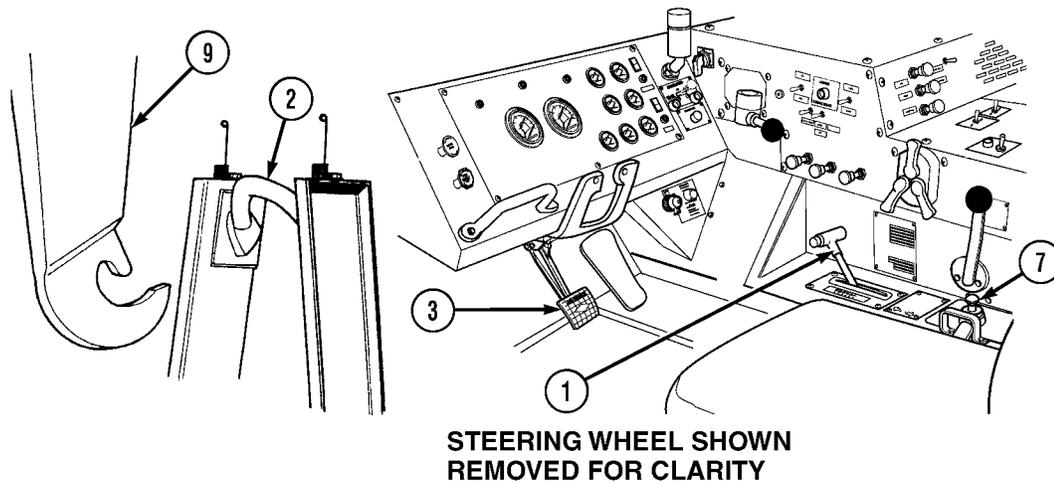

- (10) Stop truck when lift hook (9) touches flatrack/FRS.
 (11) Set transmission range selector (1) to N (Neutral).

CAUTION

- Ensure parking brake is not applied during load sequence or damage to equipment may result.
- Do not use R (Reverse) to back up truck while hook arm is attached to flatrack or damage to LHS will occur.

NOTE

- LHS will only operate when transmission range selector is in N (Neutral).
 - No additional equipment can be stowed on or in FRS during loading/unloading. Additional equipment could overload LHS due to weight of FRS.
- (12) Move joystick (7) to LOAD position to engage lift hook (9) and hook bar (2).
 (13) If lift hook (9) fails to engage hook bar (2):
 (a) Release joystick (7).
 (b) Set transmission range selector (1) to D (Drive), release service brake pedal (3), and move truck forward just clear of flatrack.
 (c) Move joystick (7) to UNLOAD position until lift hook (9) is below level of hook bar (2).
 (d) Repeat steps (9) through (12).

Operating Instructions (Cont)

2-9. LOAD HANDLING SYSTEM (LHS) (CONT).

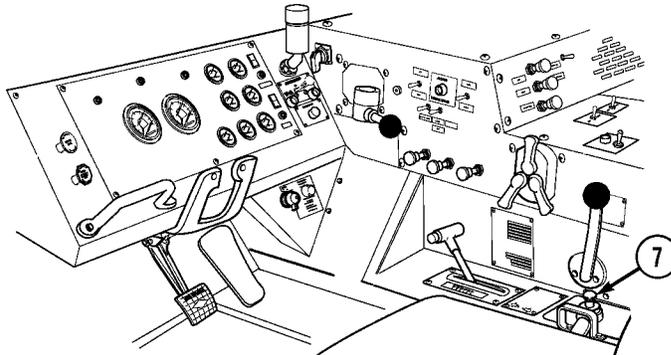

STEERING WHEEL SHOWN REMOVED FOR CLARITY

WARNING

- When loading or unloading flatracks on uneven ground (side slope or downgrades up to 5 degrees), it may be necessary to apply truck service brakes to prevent truck rollaway or severe injury or death to personnel could result.
- Prior to and during any load or unload cycle, all personnel should stay clear of LHS and flatrack or serious injury or death to personnel could result.

CAUTION

- If LHS OVER LOAD indicator illuminates but loading operation continues, operator is cautioned that LHS is nearing maximum capacity. In this situation, operator should determine if payload is evenly distributed on flatrack or if flatrack load exceeds 25,000 lbs. (11 340 kg) for LHS or 24,000 lbs. (10 886 kg) for LHS with CHU kit. If any of these conditions exist, operator must redistribute or reduce payload or damage to equipment may result.
- Ensure that parking brake is not applied before starting load sequence or damage to equipment may result.
- When loading or unloading FRS, engine speed must be at 1500 rpm.

(14) Move joystick (7) to LOAD position, allowing truck to be pulled under flatrack.

Operating Instructions (Cont)

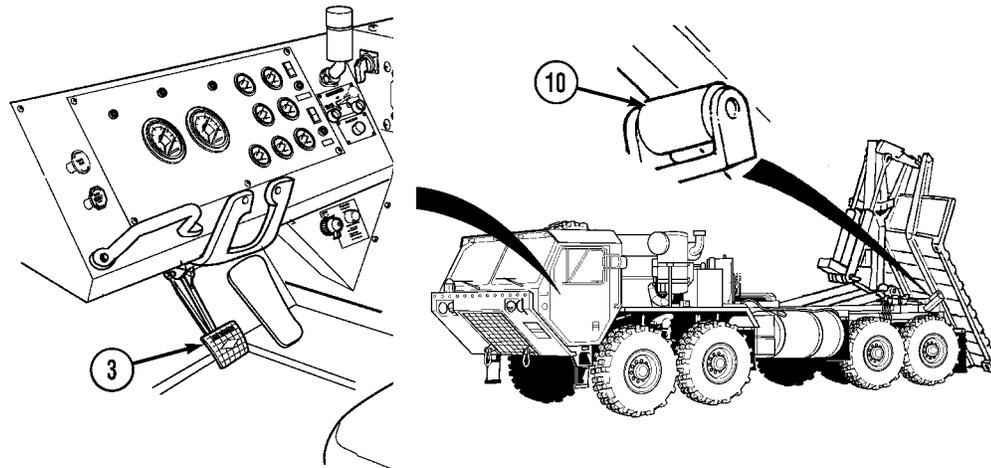

**STEERING WHEEL SHOWN
REMOVED FOR CLARITY**

WARNING

Ensure that flatrack/FRS runners contact LHS rear rollers correctly. Failure to contact flatrack/FRS runners correctly could result in serious injury or death to personnel and damage to equipment.

CAUTION

Reduce engine speed to idle before flatrack main rails contact rear rollers. Damage to flatrack may result.

NOTE

- As load is lifted, truck will be pulled under the flatrack. Some steering adjustment may have to be made to ensure that flatrack runners will contact rear rollers.
- If flatrack is being loaded in soft soil conditions, do steps (15)(16) through (19), then continue with step (20).

(15) Before flatrack contacts rear rollers (10), reduce engine speed and apply service brake pedal (3).

Operating Instructions (Cont)

2-9. LOAD HANDLING SYSTEM (LHS) (CONT).

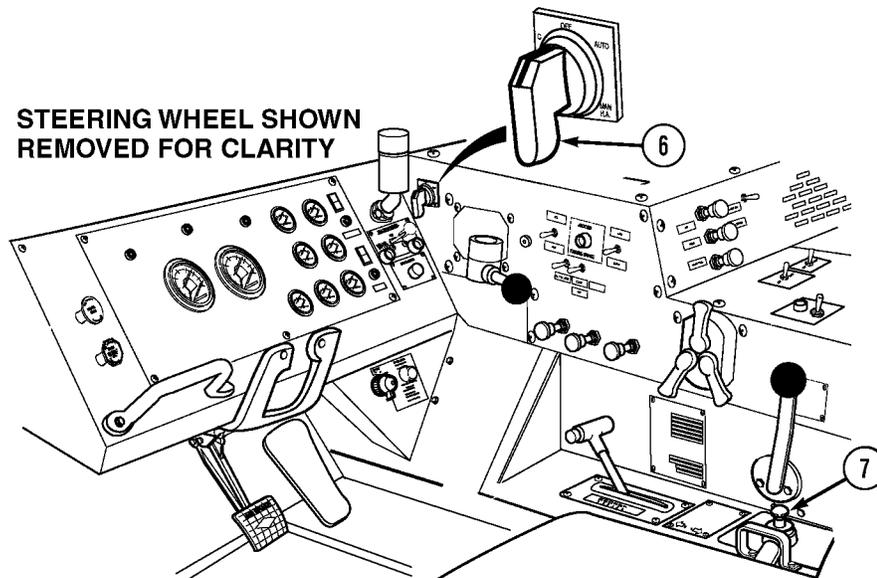

- (16) Release joystick (7). Set hydraulic selector switch (6) to MAN H.A. position.
- (17) Move joystick (7) to LOAD position until flatrack/FRS is approximately 2 ft. (0.61 m) off the ground.
- (18) Release joystick (7).
- (19) Set hydraulic selector switch (6) to MAN M.F. position.

Operating Instructions (Cont)

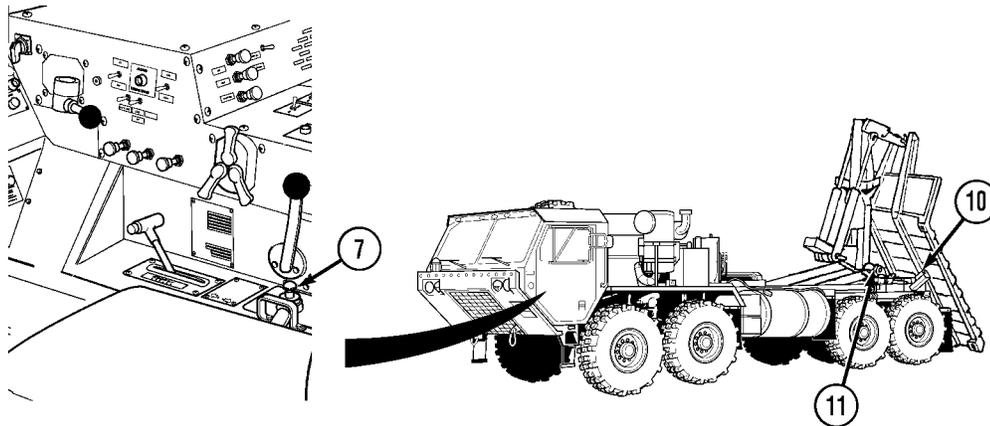

CAUTION

To avoid equipment damage, visually check that main frame cylinders do not complete full retraction while operating at engine speeds above idle.

NOTE

Engine speed will require increasing and decreasing in the following steps.

- (20) After flatrack/FRS contacts rear rollers (10), increase engine speed from 1500 to maximum rpm until main frame cylinders (11) have nearly completed full retraction.
- (21) Reduce engine speed to idle and continue loading until main frame cylinders (11) are fully retracted.

NOTE

LHS OVER LOAD indicator will come on when main frame cylinders are fully retracted and joystick is activated.

- (22) Release joystick (7).

Operating Instructions (Cont)

2-9. LOAD HANDLING SYSTEM (LHS) (CONT).

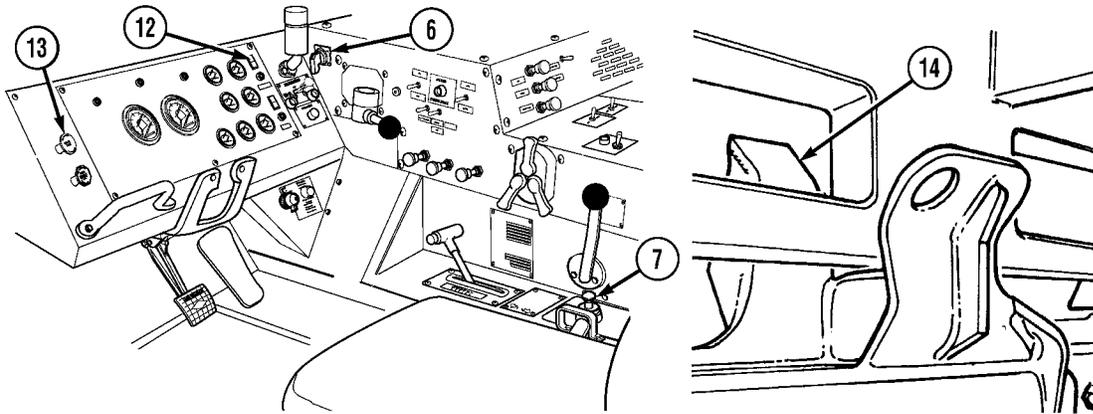

**STEERING WHEEL SHOWN
REMOVED FOR CLARITY**

CAUTION

- Engine speed must be at idle before using hydraulic selector switch, or damage to equipment may result.
- Main frame cylinders must be completely retracted prior to completely loading the hook arm.

(23) Turn hydraulic selector switch (6) to MAN H.A. position.

CAUTION

Failure to reduce engine speed to idle could result in severe damage to LHS components.

- (24) Move joystick (7) to LOAD position and increase engine speed until flatrack is nearly loaded, then reduce speed to idle.
- (25) Continue to load until LHS and flatrack/FRS are in transit position. LHS NO TRANSIT indicator (12) will go off.
- (26) Release joystick (7).
- (27) Pull out PARKING BRAKE control (13).
- (28) Make sure that load locks (14) have engaged and flatrack/FRS is fully down on truck.

Operating Instructions (Cont)

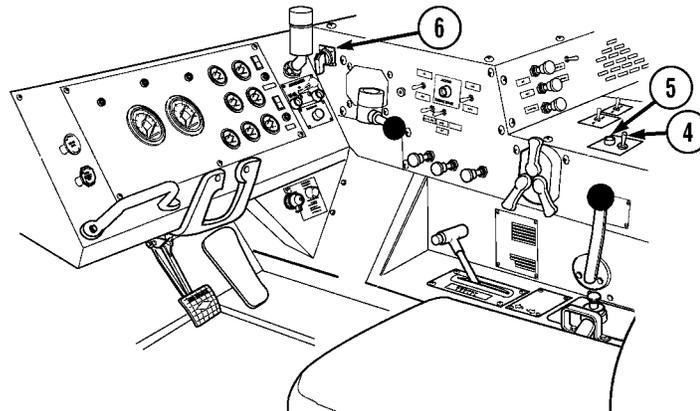

**STEERING WHEEL SHOWN
REMOVED FOR CLARITY**

CAUTION

- Hydraulic selector switch must remain in MAN TRANS position while truck is traveling or damage to equipment may result.
- Engine speed must be at idle before using hydraulic selector switch, or damage to equipment may result.

(29) Turn hydraulic selector switch (6) to MAN TRANS position.

(30) Put PTO ENGAGE switch (4) in OFF position. Make sure indicator light (5) goes off.

WARNING

- When loaded with FRS, the center of gravity is moved up and toward rear of truck. Extreme caution must be taken when turning and ascending or descending on a grade. Failure to use extreme caution could result in severe injury or death to personnel.
- Maximum side slope when loaded with a FRS or container is 30 percent. Failure to comply may result in equipment damage or severe injury or death to personnel.
- Do not reduce tire pressure when loaded with FRS or container. Highway tire pressure, 60 psi (414 kPa) front and 83 psi (572 kPa) rear, is required at all times when loaded with FRS or container. Failure to comply could result in damage to equipment and severe injury or death to personnel.

e. Off-Loading Flatrack/Forward Repair System in Manual Mode.

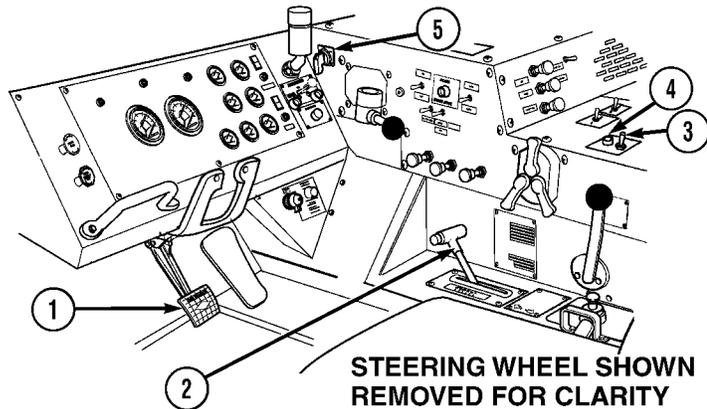

- (1) Check for sufficient operating room at front and rear of truck. Check overhead clearance and ground conditions.
- (2) Apply service brake pedal (1) and set transmission range selector (2) to N (Neutral).

CAUTION

Manual mode is used mainly in event of a failure of automatic control electrical system and when unloading an FRS. Greater care must be exercised during operation of manual mode for correct cycle of events to occur, or damage to equipment may result.

- (3) Put PTO ENGAGE switch (3) in ON position. Make sure indicator light (4) comes on.
- (4) Turn hydraulic selector switch (5) to MAN H.A. position.

Operating Instructions (Cont)

2-9. LOAD HANDLING SYSTEM (LHS) (CONT).

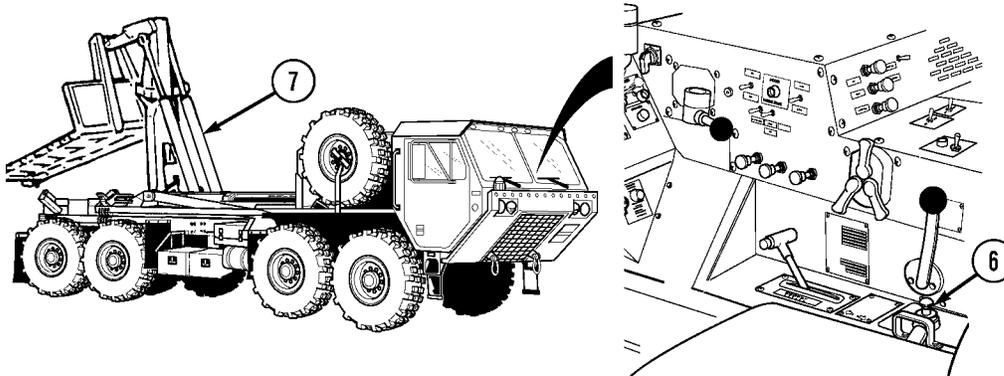

WARNING

- Check for overhead power lines or other obstructions before attempting LHS operation. LHS reaches a height of 17 ft. 2 in. (5.23 m) with ISO container. Serious injury or death to personnel could result from contact with electrical power lines.
- Check ground conditions for firmness and extreme sideways inclination before picking up or off-loading a flatrack. Any ground instability beneath road wheels could cause serious injury or death to personnel.
- Prior to and during any load or unload cycle, all personnel should stay clear of LHS and flatrack or serious injury or death to personnel could result.

CAUTION

- Reduce speed to idle for approximately the first 18 in. (46 cm) of travel and again when flatrack is 2 ft. (61 cm) above ground to prevent damage to cylinder.
- To avoid equipment damage, insure that hook arm cylinders do not complete full extension while operating at engine speeds above idle.
- Ensure rail transport locking pins are disengaged before unloading flatrack. Rail transport locking pins are used for rail transport only. Failure to comply may result in damage to equipment.

NOTE

- LHS OVER LOAD indicator may come on when engine is at idle speed.
- When unloading an FRS, engine speed must be at 1500 RPM.

(5) Move joystick (6) to UNLOAD position until hook arm cylinders (7) have fully extended. Maintain engine speed at idle for approximately the first 18 in. (46 cm) and last 6 in. (15 cm) of movement.

NOTE

When hook arm cylinders are fully extended and joystick activated, LHS OVER LOAD indicator will illuminate.

(6) Release joystick (6).

Operating Instructions (Cont)

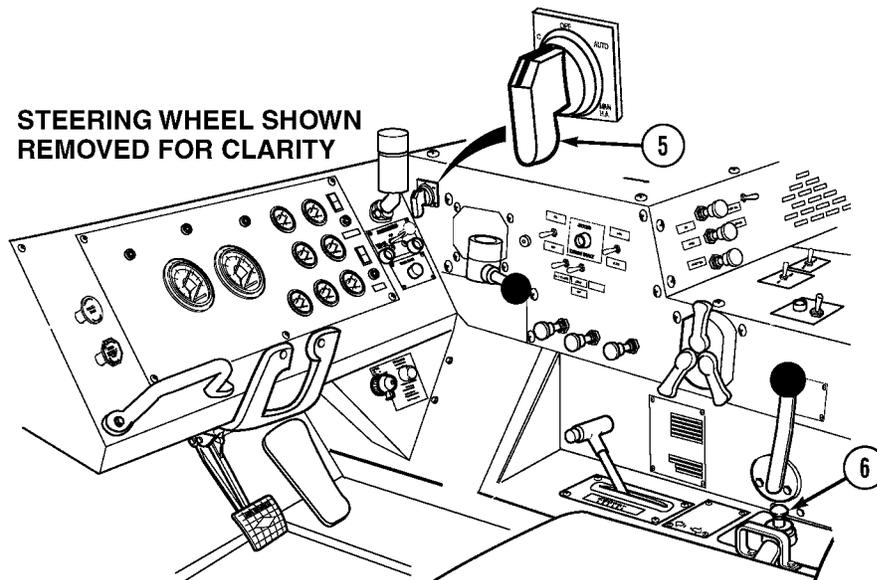
**CAUTION**

- Engine speed must be at idle before using hydraulic selector switch, or damage to equipment may result.
- Ensure parking brake is released before starting the unload sequence or damage to equipment may result.

- (7) Turn hydraulic selector switch (5) to MAN M.F. position.
(8) Move joystick (6) to UNLOAD position.

Operating Instructions (Cont)

2-9. LOAD HANDLING SYSTEM (LHS) (CONT).

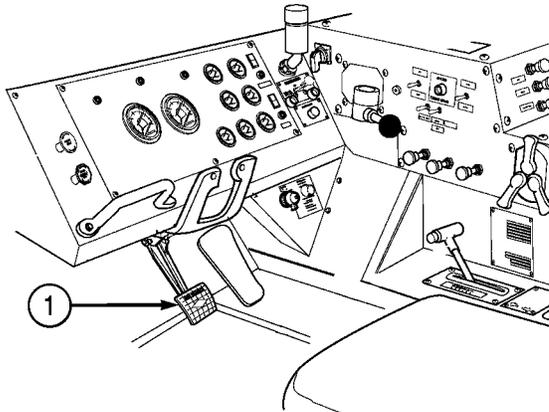

**STEERING WHEEL SHOWN
REMOVED FOR CLARITY**

WARNING

When loading or unloading flatracks/FRS on uneven ground (side slope or down grades up to 5 degrees), it may be necessary to apply truck service brakes to prevent truck rollaway or severe injury or death to personnel could result.

NOTE

If flatrack is extremely light or empty, it may be necessary to place transmission range selector to D (Drive) to allow truck to move out from under flatrack.

- (9) When back edge of flatrack/FRS touches ground, release service brake pedal (1), allowing truck to be pushed straight from under flatrack.
- (10) Continue off-loading until front of flatrack/FRS is within 8 in. (20.32 cm) of ground, decrease engine speed to idle, and apply service brake pedal (1).

Operating Instructions (Cont)

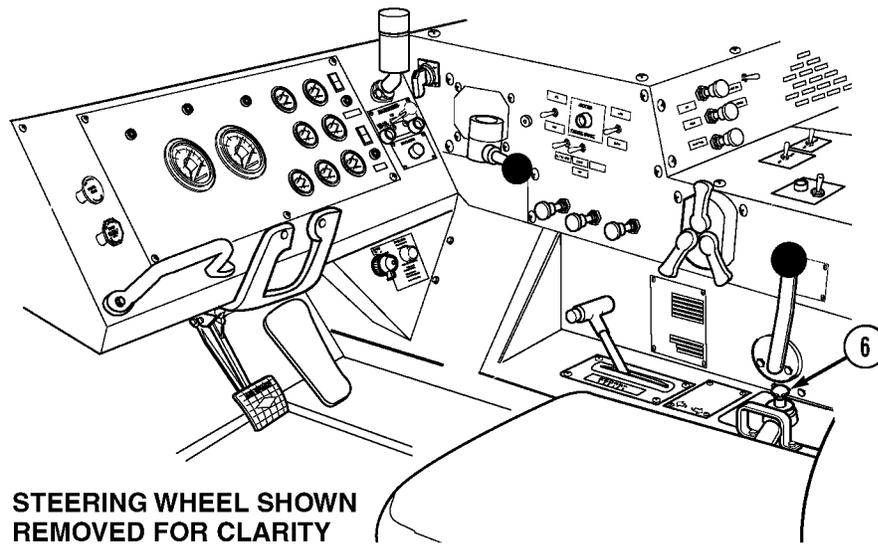

CAUTION

Once suspension has been relieved of flatrack load, do not continue in UNLOAD position or rear of truck could jack up with hook arm and equipment damage may result.

- (11) Continue off-loading until flatrack/FRS is on ground and rear suspension is unloaded.
- (12) Release joystick (6).

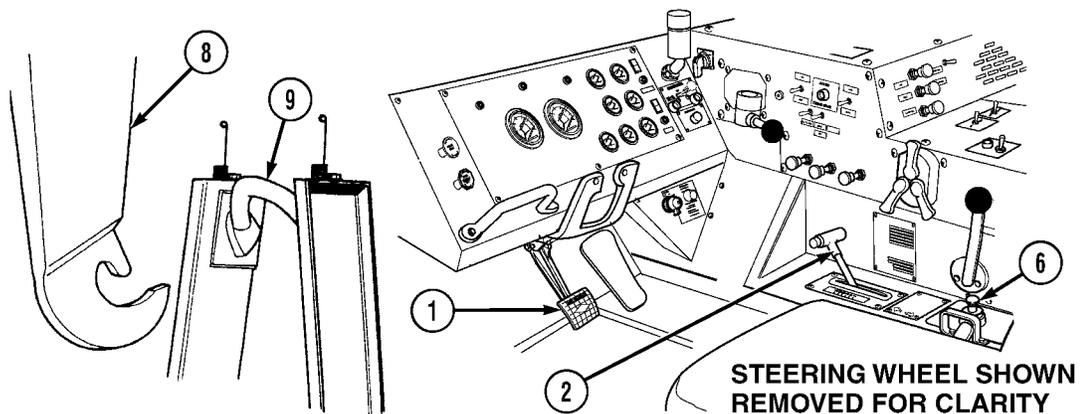

NOTE

- Engine speed should be set at idle. However, slight increase in engine speed may be necessary depending on terrain.
 - LHS will only operate when transmission range selector is in N (Neutral).
- (13) Set transmission range selector (2) to D (Drive) and release service brake pedal (1).
 - (14) Move joystick (6) to LOAD position momentarily and then to UNLOAD position to let lift hook (8) disengage from hook bar (9). Repeat step (14) until lift hook disengages.
 - (15) Move truck forward approximately 5 ft. (1.5 m).
 - (16) Stop truck and set transmission range selector (2) to N (Neutral).

Operating Instructions (Cont)

2-9. LOAD HANDLING SYSTEM (LHS) (CONT).

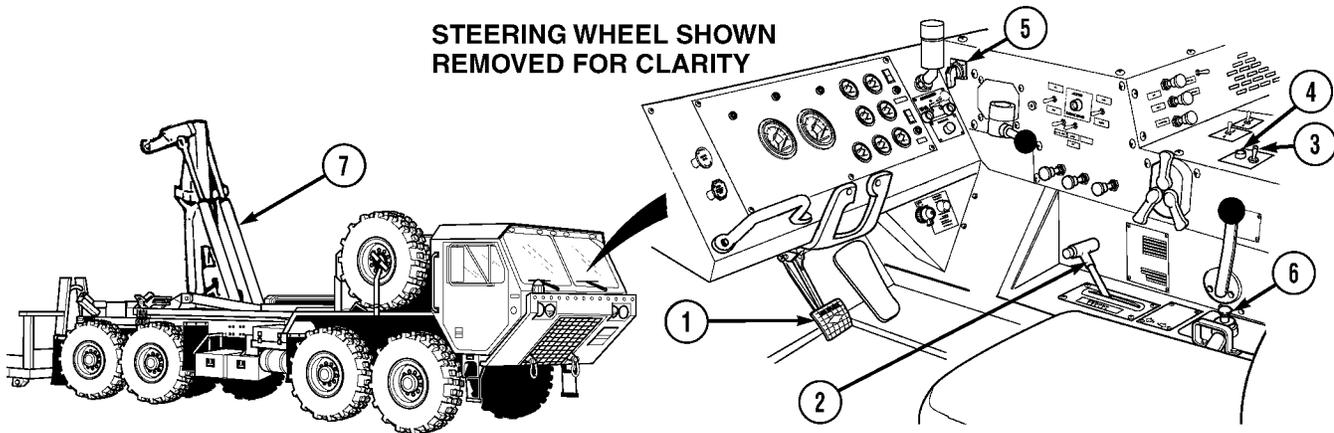

CAUTION

- To avoid equipment damage, visually check that main frame cylinders have completed full retraction.
- Reduce speed to idle in last 12 in. (31 cm) of travel to prevent damage to cylinders.

(17) Move joystick (6) to LOAD position and hold in this position until main frame cylinders are fully retracted.

CAUTION

Engine speed must be at idle before using hydraulic selector switch, or damage to equipment may result.

- (18) Turn hydraulic selector switch (5) to MAN H.A. position.
 (19) Hold joystick (6) in LOAD position until the hook arm cylinders (7) are fully retracted.
 (20) Release joystick (6).

WARNING

Never drive with LHS NO TRANSIT indicator illuminated. An illuminated indicator means LHS is not fully stowed. The load could break loose causing serious injury or death to personnel.

- (21) Turn hydraulic selector switch (5) to MAN TRANS.
 (22) Put PTO ENGAGE switch (3) in OFF position. Make sure indicator light (4) goes off.

Operating Instructions (Cont)

f. Normal Transfer of Flatrack to Trailer.

WARNING

- Prior to and during any load or unload cycle, all personnel should stay clear of LHS and flatrack or serious injury or death to personnel could result.
- Trailer wheels must be chocked during transfer operations or serious injury or death to personnel could result.

CAUTION

- Ensure that trailer drawbar is down against the ground during transfer operations or damage to equipment may result.
- Ensure air lines and cables are properly stowed to prevent damage to equipment (TM 9-2330-385-14).
- Both trailer bumper points must be under the truck bumper flange and at least one of the bumper points must contact the bumper stop. The trailer bumper point not contacting the truck bumper stop cannot exceed 0.5 in. (12.7 mm) or flatrack will miss main rail guides and equipment damage may result.

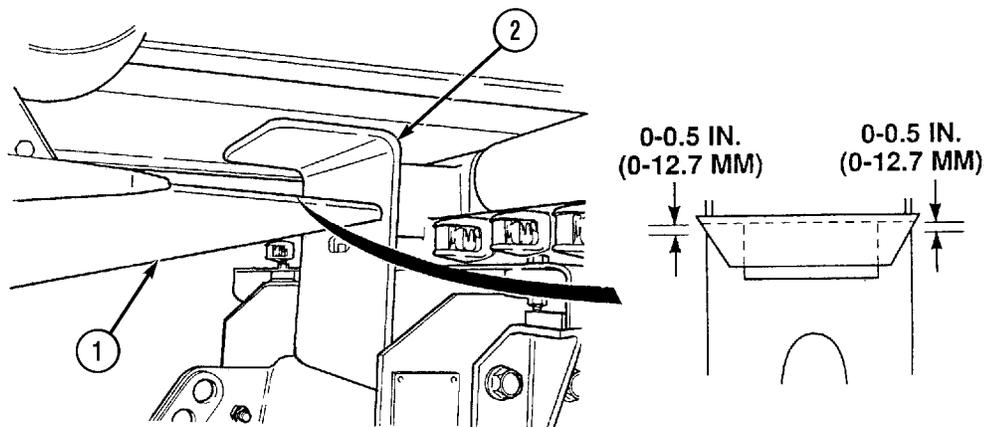

- (1) Back up truck so that trailer bumper (1) is under flange and contacts truck bumper stop (2).

Operating Instructions (Cont)

2-9. LOAD HANDLING SYSTEM (LHS) (CONT).

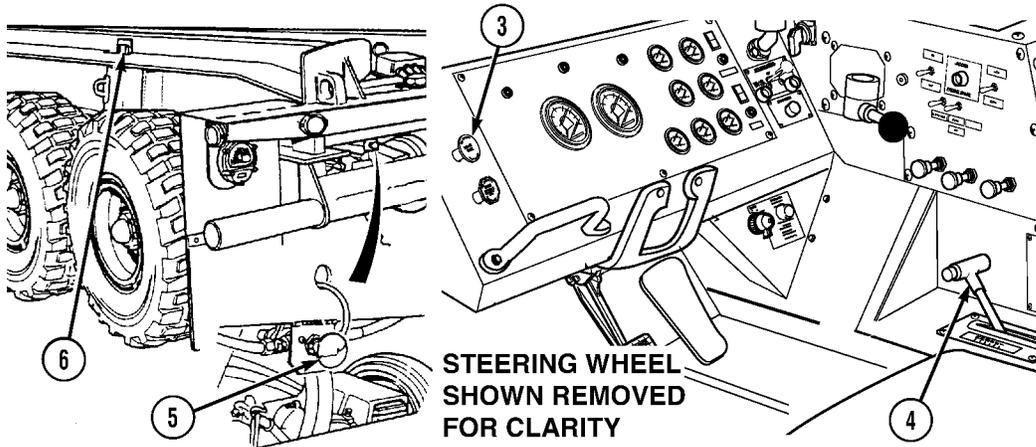

(2) Pull out PARKING BRAKE control (3) and set transmission range selector (4) to N (Neutral).

WARNING

- When operating M1120 truck with M1076 trailer, the heaviest loaded flatrack must always be placed on the truck, otherwise adverse handling and/or braking may result, causing injury or death to personnel.
- Ensure trailer air system is pressurized before beginning transfer, or flatrack locks may not properly engage/disengage. Serious injury or death to personnel could result.

CAUTION

There must be sufficient air pressure in trailer air system to retract flatrack locks or damage to flatrack locks can occur while attempting to load flatrack on trailer. If not, use truck to charge trailer air system using trailer air charging hose. If air system cannot retract flatrack locks, use manual flatrack lock retract procedure (TM 9-2330-385-14).

(3) Push knob (5) in and retract flatrack locks (6) on trailer.

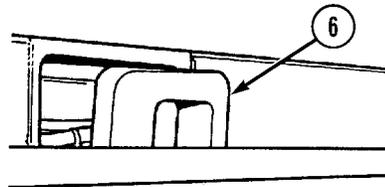

CAUTION

Ensure both flatrack locks are fully retracted or damage to equipment may result.

(4) Inspect that both flatrack locks (6) are fully retracted.

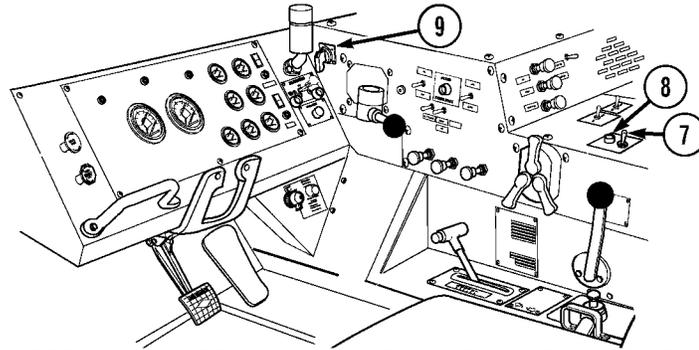
Operating Instructions (Cont)**STEERING WHEEL SHOWN REMOVED FOR ASSEMBLY****CAUTION**

Engine speed must be at idle before using hydraulic selector switch or damage to equipment may result.

- (5) Put PTO ENGAGE switch (7) in ON position. Make sure indicator light (8) comes on.
- (6) Turn hydraulic selector switch (9) to AUTO position.

Operating Instructions (Cont)

2-9. LOAD HANDLING SYSTEM (LHS) (CONT).

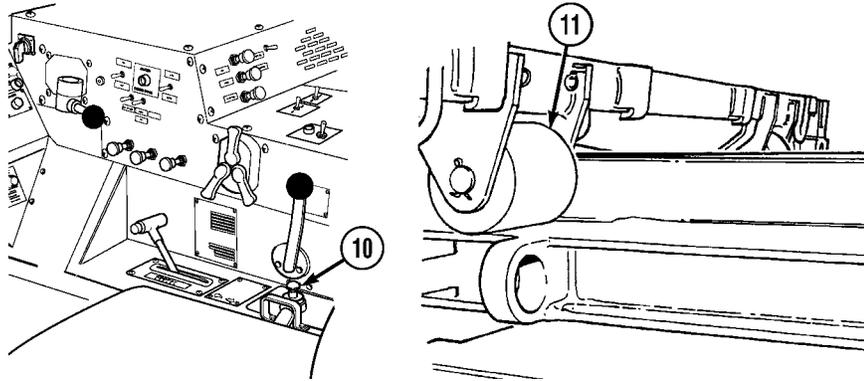

WARNING

- When loading or unloading flatracks on uneven ground (side slope or downgrades up to 5 degrees), it may be necessary to apply truck service brakes to prevent truck rollaway or severe injury or death to personnel could result.
- Check for overhead power lines or other obstructions before attempting LHS operation. LHS reaches a height of 17 ft. 2 in. (5.23 m) with ISO container. Serious injury or death to personnel could result from contact with electrical power lines.
- Trailer wheels must be chocked during transfer operations or serious injury or death to personnel could result.

CAUTION

- Load must be evenly distributed on flatrack. Uneven load distribution may cause LHS OVER LOAD indicator to give false signals and cause LHS to operate incorrectly.
- Ensure rail transport locking pins are disengaged before unloading flatrack. Rail transport locking pins are used for rail transport only. Failure to comply may result in damage to equipment.

NOTE

- The amount of time to load and unload is controlled by engine speed. Engine speed can be increased to 1,500 to maximum rpm to reduce loading and unloading times.
- LHS will only operate when transmission range selector is in N (Neutral).

(7) Move joystick (10) to UNLOAD position until flatrack rollers (11) contact trailer.

Operating Instructions (Cont)

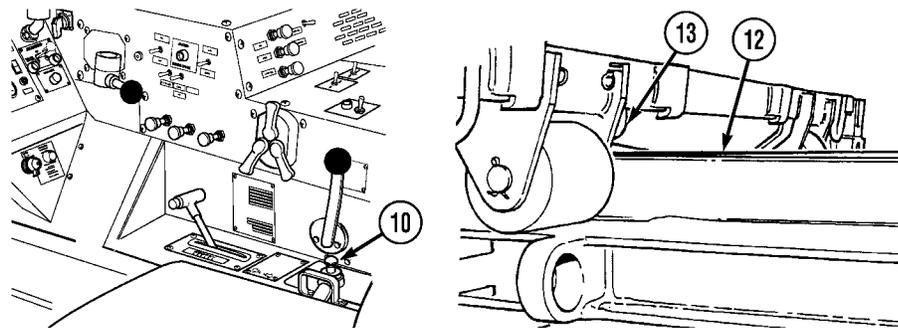

- (8) Release joystick (10).
- (9) Inspect and verify trailer guides (12) are lined up between flatrack main rails (13).

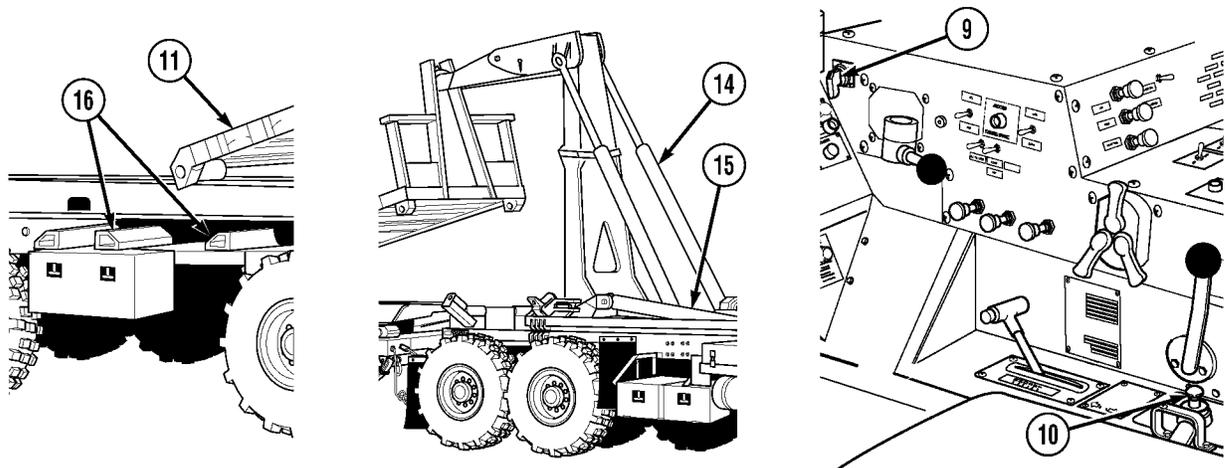

NOTE

If not alined, do step (10). If alined, go to step (11).

- (10) If not alined:
 - (a) Move joystick (10) to LOAD position.
 - (b) When flatrack is fully reloaded, release joystick (10).
 - (c) Repeat steps (6) through (8).
- (11) Move joystick (10) to UNLOAD position until hook arm cylinders (14) have fully extended and main frame cylinders (15) have extended 6 to 12 in. (35 to 30 cm).
- (12) Release joystick (10).

CAUTION

Engine speed must be at idle before using hydraulic selector switch or damage to equipment may result.

- (13) Turn hydraulic selector switch (9) to MAN H.A. position.
- (14) Move joystick (10) to LOAD until flatrack rear rollers (11) are centered between trailer stacking brackets (16).
- (15) Release joystick (10).
- (16) Turn hydraulic selector switch (9) to MAN M.F. position.

Operating Instructions (Cont)

2-9. LOAD HANDLING SYSTEM (LHS) (CONT).

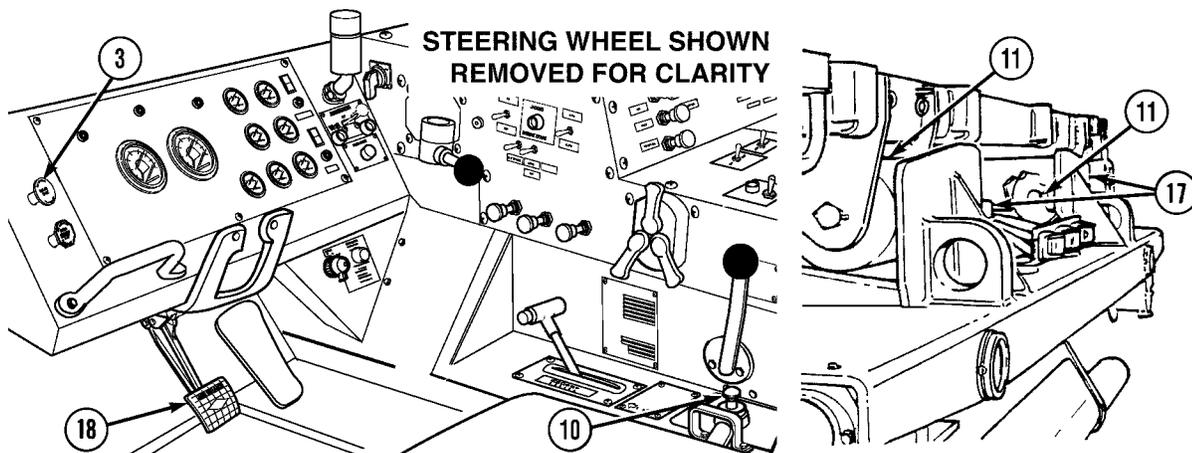

- (17) Move joystick (10) to UNLOAD position until flatrack rollers (11) contact rear trailer stops (17).
- (18) Release joystick (10).
- (19) Inspect that rear rollers (11) on flatrack have contacted rear trailer stops (17).
- (20) Apply service brake pedal (18).
- (21) Push in truck PARKING BRAKE control (3).

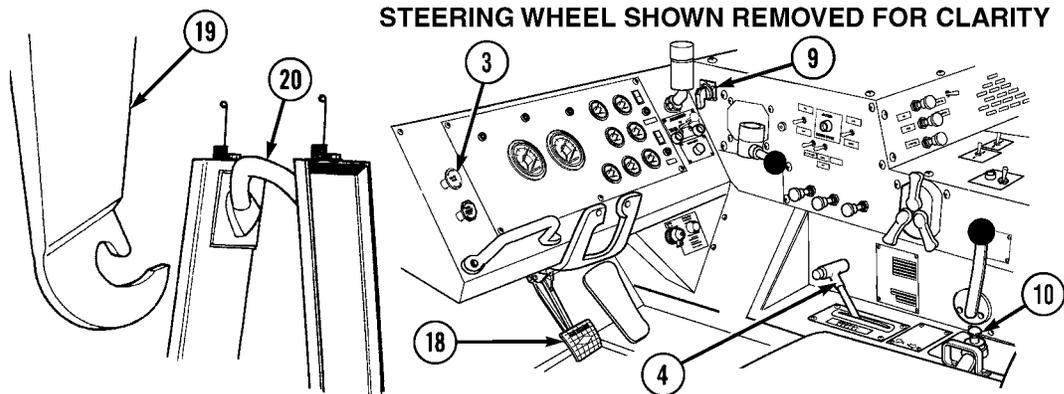

- (22) Turn hydraulic selector switch (9) to MAN H.A.
- (23) Move joystick (10) to UNLOAD position until flatrack is fully seated on trailer.

NOTE

It may be necessary to repeat steps (24) through (26) several times to clear hook arm from hook bar.

- (24) Move joystick (10) to LOAD position to allow top of lift hook (19) to clear hook bar (20).

NOTE

- Do not move truck forward more than 3 in. (76.2 mm) to prevent flatrack from pulling away from rear trailer stops.
- LHS will only operate when transmission range selector is in N (Neutral).

- (25) Place transmission range selector (4) in D (Drive). Release service brake pedal (18) and move truck forward approximately 3 in. (76.2 mm). Apply service brake pedal (18).
- (26) Move the joystick (10) to UNLOAD position to disengage lift hook (19) from hook bar (20).
- (27) Set transmission range selector (4) to N (Neutral) and pull out PARKING BRAKE control (3).

Operating Instructions (Cont)

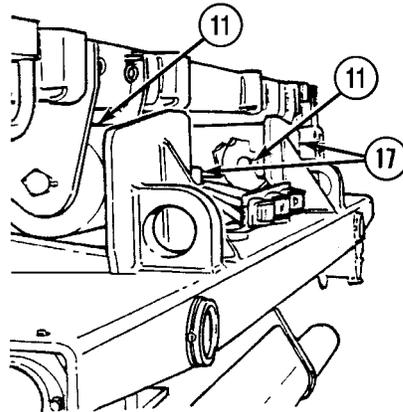

(28) Inspect that rear flatrack rollers (11) have contacted trailer stops (17).

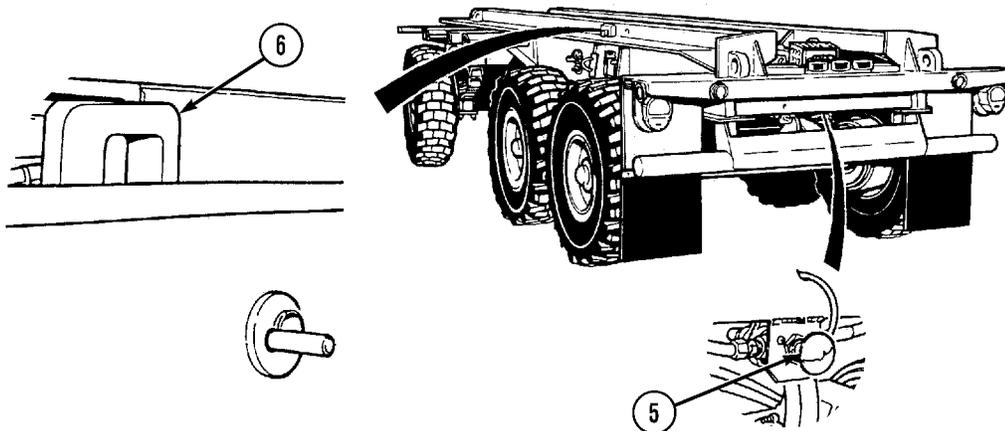

(29) Pull knob (5) and engage flatrack locks (6).

(30) Inspect that flatrack locks (6) are engaged.

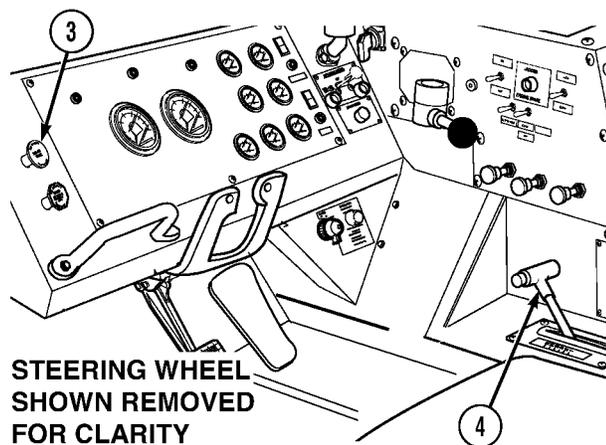

(31) Push in PARKING BRAKE control (3).

(32) Set transmission range selector (4) to D (Drive).

(33) Move truck forward approximately 5 ft. (1.5 m).

(34) Pull out PARKING BRAKE control (3) and set transmission range selector (4) to N (Neutral).

Operating Instructions (Cont)

2-9. LOAD HANDLING SYSTEM (LHS) (CONT).

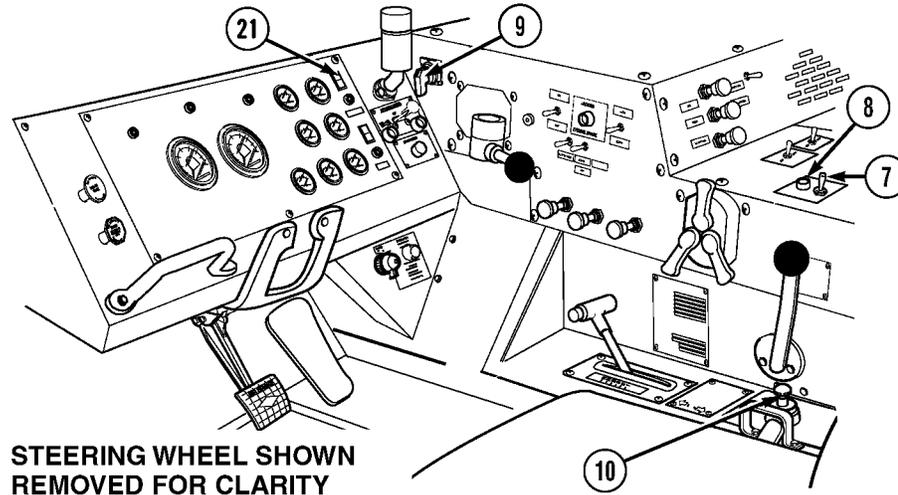

WARNING

Never drive with LHS NO TRANSIT indicator illuminated. An illuminated indicator means LHS is not fully stowed. The load could break loose causing serious injury or death to personnel.

CAUTION

Engine speed must be at idle before using hydraulic selector switch or damage to equipment may result.

NOTE

Hook arm does not need to be fully stowed if more transfer operations are going to be made.

- (35) Turn hydraulic selector switch (9) to AUTO position.
- (36) Move joystick (10) to LOAD position and retract LHS until LHS NO TRANSIT indicator (21) is extinguished.
- (37) Turn hydraulic selector switch (9) to OFF position.
- (38) Put PTO ENGAGE switch (7) in OFF position. Make sure indicator light (8) goes off.

Operating Instructions (Cont)

g. Normal Removal of Flatrack from Trailer.

WARNING

- Prior to and during any load or unload cycle, all personnel should stay clear of LHS and flatrack or serious injury or death to personnel could result.
- Trailer wheels must be chocked during transfer operations or serious injury or death to personnel could result.

CAUTION

- Ensure that trailer drawbar is down against the ground during transfer operations or damage to equipment may result.
- Ensure air lines and cables are properly stowed to prevent damage to equipment (TM 9-2330-385-14).

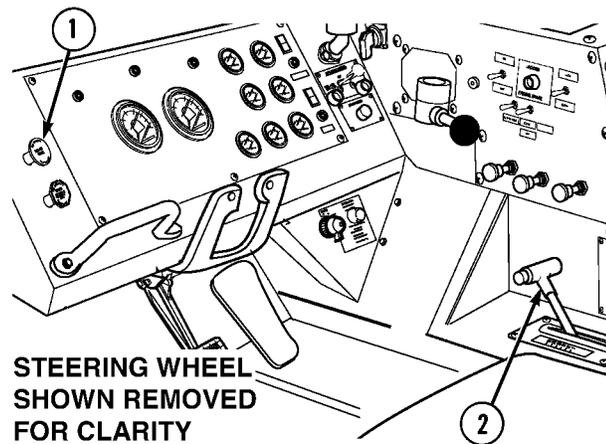

CAUTION

Load must be evenly distributed on pallet. Uneven load distribution may cause LHS OVER LOAD indicator to give false signals and cause LHS to operate incorrectly. Damage to equipment may result.

- (1) Back up the truck in line with trailer and stop approximately 5 ft. (1.5 m) from trailer.
- (2) Pull out PARKING BRAKE control (1) and place transmission range selector (2) in N (Neutral).

Operating Instructions (Cont)

2-9. LOAD HANDLING SYSTEM (LHS) (CONT).

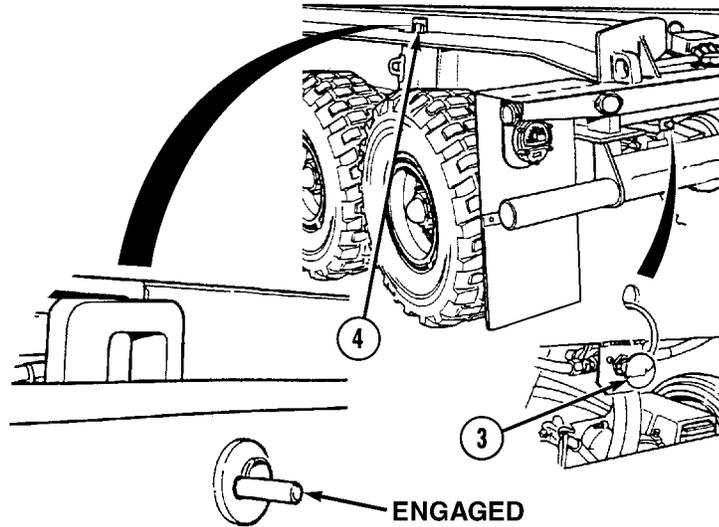

CAUTION

- There must be sufficient air pressure in trailer air system to retract flatrack locks or damage to flatrack lock can occur while attempting to remove flatrack from trailer. If not, use truck to charge trailer air system using trailer air charging hose. If air system cannot retract flatrack locks, use manual flatrack lock retract procedure (TM 9-2330-385-14).
- Ensure air lines and cables are properly stowed to prevent damage to equipment (TM 9-2330-385-14).
- Ensure that trailer drawbar is down against the ground during transfer operations or damage to equipment may result.

(3) Push knob (3) on trailer to retract flatrack locks (4).

CAUTION

Ensure both flatrack locks are fully retracted or damage to equipment may result.

(4) Inspect that both flatrack locks (4) are fully retracted.

Operating Instructions (Cont)

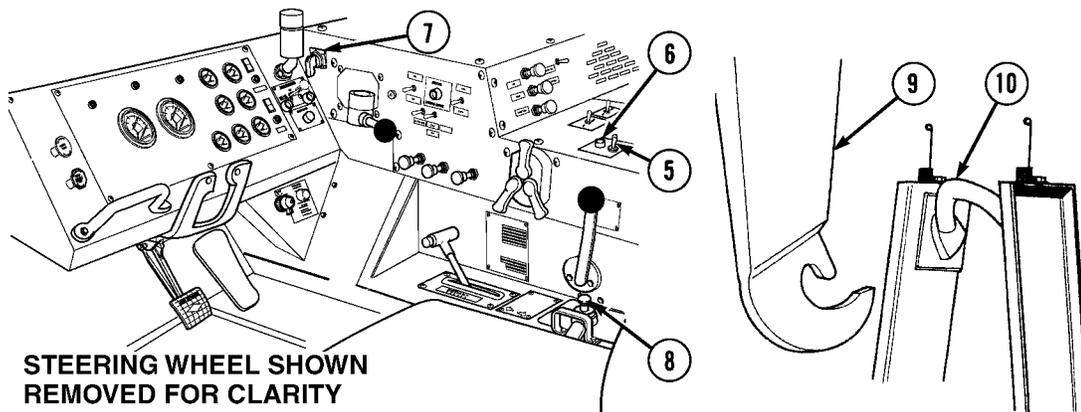

WARNING

- Check for overhead power lines or other obstructions before attempting LHS operation. LHS reaches a height of 17 ft. 2 in. (5.23 m) with ISO container. Serious injury or death to personnel could result from contact with electrical power lines.
- Check ground conditions for firmness and extreme sideways inclination before picking up or off-loading a flatrack. Any ground instability beneath road wheels could cause serious injury or death to personnel.
- Prior to and during any load or unload cycle, all personnel should stay clear of LHS and flatrack or serious injury or death to personnel could result.
- Trailer wheels must be chocked during transfer operations or serious injury or death to personnel could result.

CAUTION

- Engine speed must be at idle before using hydraulic selector switch or damage to equipment may result.
- Ensure rail transport locking pins are disengaged before unloading flatrack. Rail transport locking pins are used for rail transport only. Failure to comply may result in damage to equipment.

NOTE

LHS will only operate when transmission range selector is in N (Neutral).

- (5) Put PTO ENGAGE switch (5) in ON position. Make sure indicator light (6) comes on.
- (6) Turn hydraulic selector switch (7) to AUTO position.
- (7) Move joystick (8) to UNLOAD position until lift hook (9) has moved just below level of flatrack hook bar (10).

Operating Instructions (Cont)

2-9. LOAD HANDLING SYSTEM (LHS) (CONT).

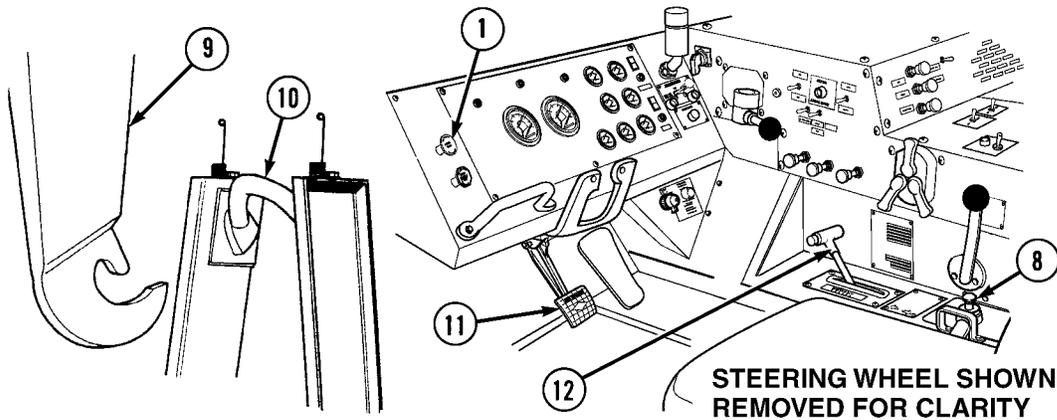

NOTE

LHS will only operate when transmission range selector is in N (Neutral).

- (8) Apply service brake pedal (11) and push in PARKING BRAKE control (1).
- (9) Set transmission range selector (12) to R (Reverse), release service brake pedal (11), and back truck up until lift hook (9) contacts hook bar (10).

WARNING

- When loading or unloading flatracks on uneven ground (side slope or downgrades up to 5 degrees), it may be necessary to apply truck service brakes to prevent truck rollaway or severe injury or death to personnel could result.
- Prior to and during any load or unload cycle, all personnel should stay clear of LHS and flatrack or serious injury or death to personnel could result.

- (10) Set transmission range selector (12) to N (Neutral) and apply service brake pedal (11).

NOTE

Loading and unloading times are controlled by engine speed. Engine speed can be increased to 1,500 to maximum rpm to reduce loading and unloading times.

- (11) Move joystick (8) to LOAD position and engage lift hook (9) into hook bar (10).

Operating Instructions (Cont)

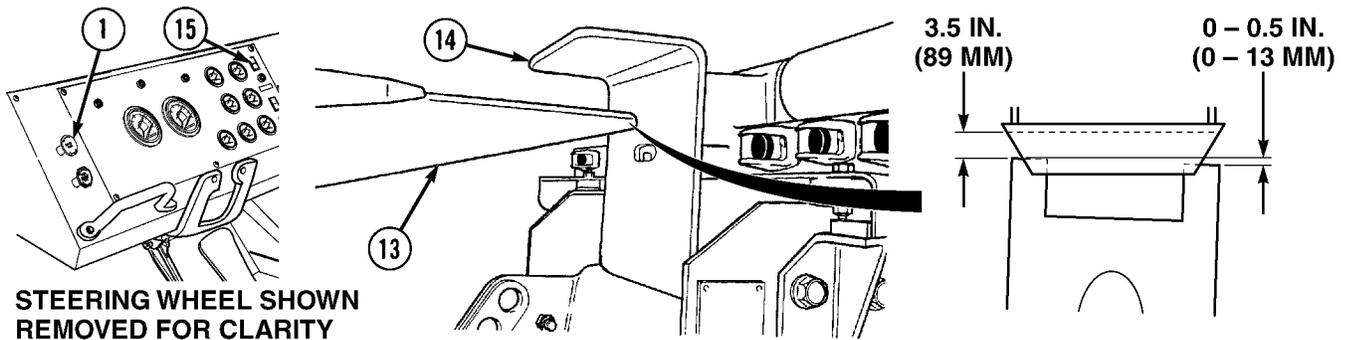

STEERING WHEEL SHOWN REMOVED FOR CLARITY

- (12) Pull out PARKING BRAKE control (1) and check that trailer bumper (13) is under flange and within 3.5 in. (89 mm) from truck bumper stop (14).
- (13) Push in PARKING BRAKE control (1) and continue loading flatrack onto truck until the LHS NO TRANSIT indicator (15) goes off indicating LHS is in transport position.
- (14) Pull out PARKING BRAKE control (1) and set the transmission range selector (12) to N (Neutral).

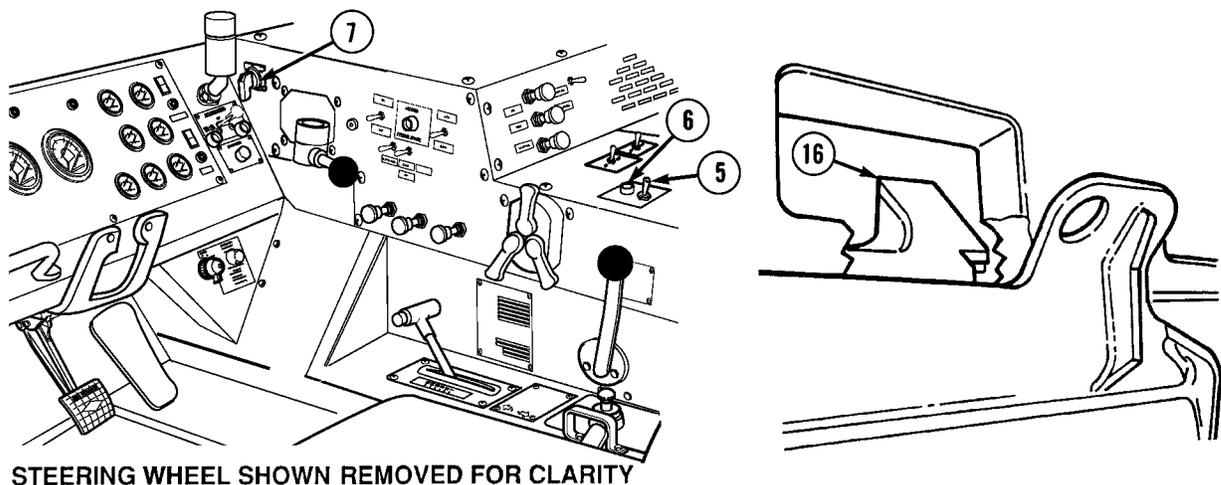

STEERING WHEEL SHOWN REMOVED FOR CLARITY

NOTE

If load locks do not engage, raise flatrack slightly and lower again. Flatrack should seat completely and engage load locks.

- (15) Inspect that the load locks (16) are engaged and flatrack is completely down on truck.

CAUTION

Engine speed must be at idle before using hydraulic selector switch or damage to equipment may result.

- (16) Turn hydraulic selector switch (7) to OFF position.
- (17) Put PTO ENGAGE switch (5) in OFF position. Make sure indicator light (6) goes off.

Operating Instructions (Cont)

2-9. LOAD HANDLING SYSTEM (LHS) (CONT).

h. Transfer of Flatrack to Trailer in Manual Mode.

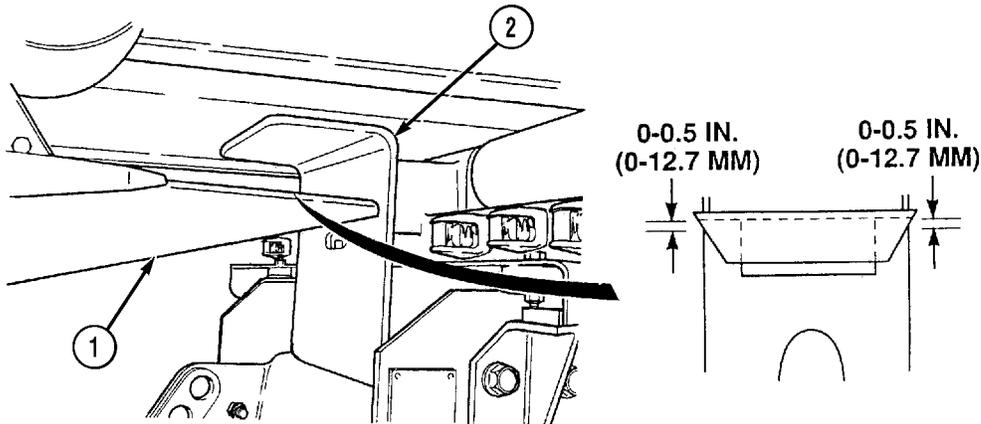

WARNING

Trailer wheels must be chocked during transfer operations or serious injury or death to personnel could result.

CAUTION

- Ensure that trailer drawbar is down against the ground during transfer operations or damage to equipment may result.
- Ensure air lines and cables are properly stowed to prevent damage to equipment (TM 9-2330-385-14).
- Both of the trailer bumper points must be under the truck bumper stop flange and at least one of the bumper points must contact the bumper stop. The trailer bumper point not contacting the truck bumper stop cannot exceed 0.5 in. (12.7 mm) or flatrack will miss main rail guides and equipment damage may result.

(1) Back up the truck so that trailer bumper (1) is under flange and contacts truck bumper stop (2).

Operating Instructions (Cont)

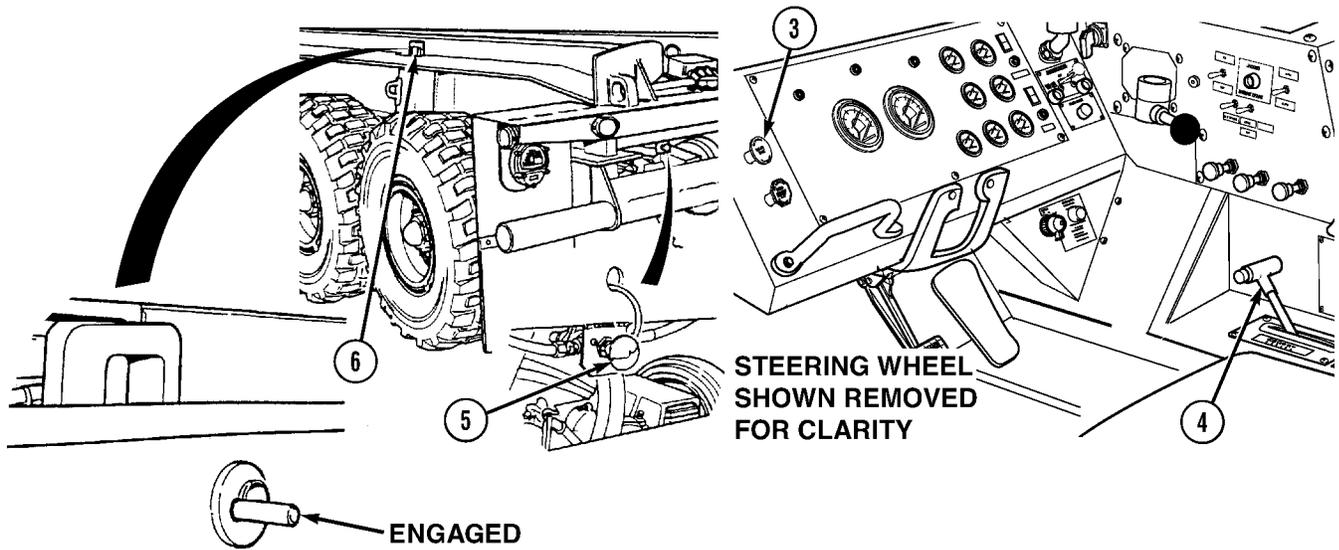

- (2) Pull out PARKING BRAKE control (3) and place transmission range selector (4) in N (Neutral).

WARNING

Ensure trailer air system is pressurized before beginning transfer, or flatrack locks may not properly disengage. Serious injury or death could result to personnel and damage to equipment may result.

- (3) Push in knob (5) and retract flatrack locks (6).

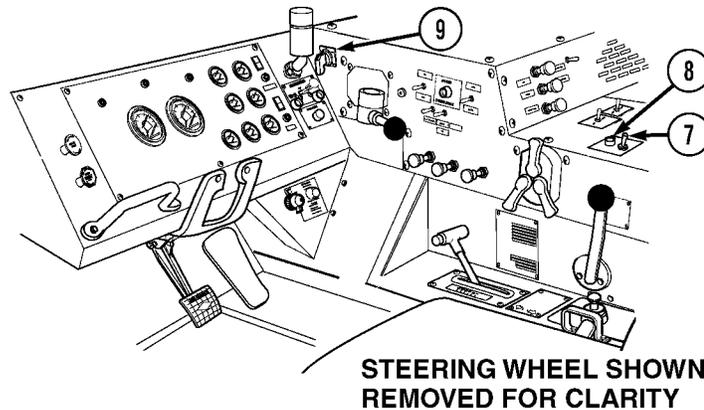

CAUTION

- Engine speed must be at idle before using hydraulic selector switch or damage to equipment may result.
- Load must be evenly distributed on flatrack pallet. Uneven load distribution may cause LHS OVER LOAD indicator to give false signals and cause LHS to operate incorrectly.

NOTE

The time to load and unload is controlled by engine speed. Engine speed can be increased to 1,500 to maximum rpm to reduce loading and unloading times.

- (4) Put PTO ENGAGE switch (7) in ON position. Make sure indicator light (8) comes on.
 (5) Turn the hydraulic selector switch (9) to MAN H.A. position.

Operating Instructions (Cont)

2-9. LOAD HANDLING SYSTEM (LHS) (CONT).

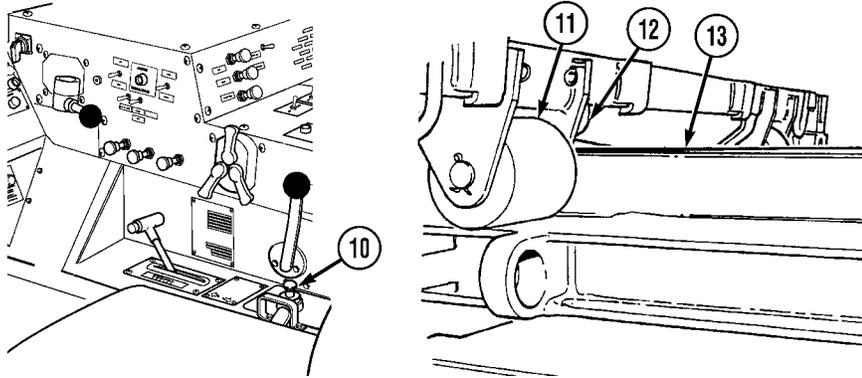

WARNING

- Check for overhead power lines or other obstructions before attempting LHS operation. LHS reaches a height of 17 ft. 2 in. (5.23 m) with ISO container. Serious injury or death to personnel could result from contact with electrical power lines.
- Check ground conditions for firmness and extreme sideways inclination before picking up or off-loading a flatrack. Any ground instability beneath road wheels could cause serious injury or death to personnel.
- Prior to and during any load or unload cycle, all personnel should stay clear of LHS and flatrack or serious injury or death to personnel could result.
- Ensure rail transport locking pins are disengaged before unloading flatrack. Rail transport locking pins are used for rail transport only. Failure to comply may result in damage to equipment.

NOTE

LHS will only operate when transmission range selector is in N (Neutral).

- (6) Move the joystick (10) to UNLOAD position until flatrack rollers (11) contact trailer.
- (7) Release the joystick (10).
- (8) Inspect and verify that trailer guides (12) are between flatrack main rails (13).

Operating Instructions (Cont)

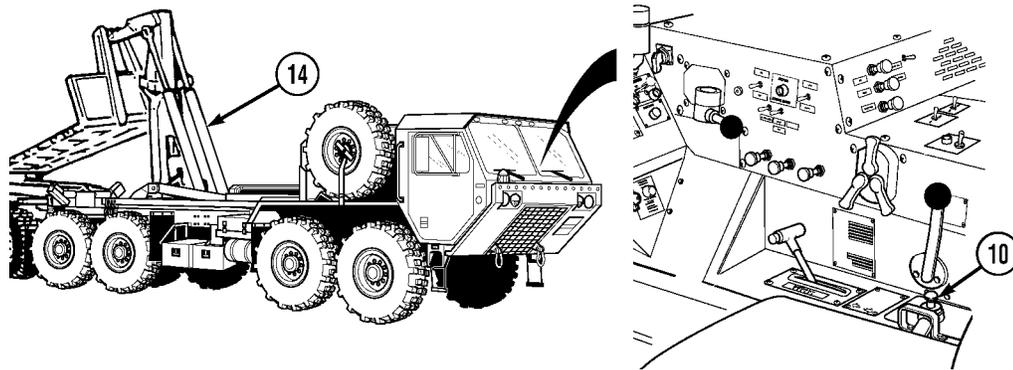

- (9) If not alined:
- (a) Move joystick (10) to LOAD position.
 - (b) When flatrack is completely reloaded onto truck, release joystick (10).
 - (c) Repeat steps (4) through (7).

CAUTION

- To avoid equipment damage, visually check that hook arm cylinders have fully extended.
- To avoid equipment damage, ensure that hook arm cylinders do not complete full extension while operating at engine speeds above idle.

NOTE

LHS OVER LOAD indicator will come on when hook arm cylinders are fully extended and joystick is activated.

- (10) Move the joystick (10) to UNLOAD position and hold until hook arm cylinders (14) are fully extended.

Operating Instructions (Cont)

2-9. LOAD HANDLING SYSTEM (LHS) (CONT).

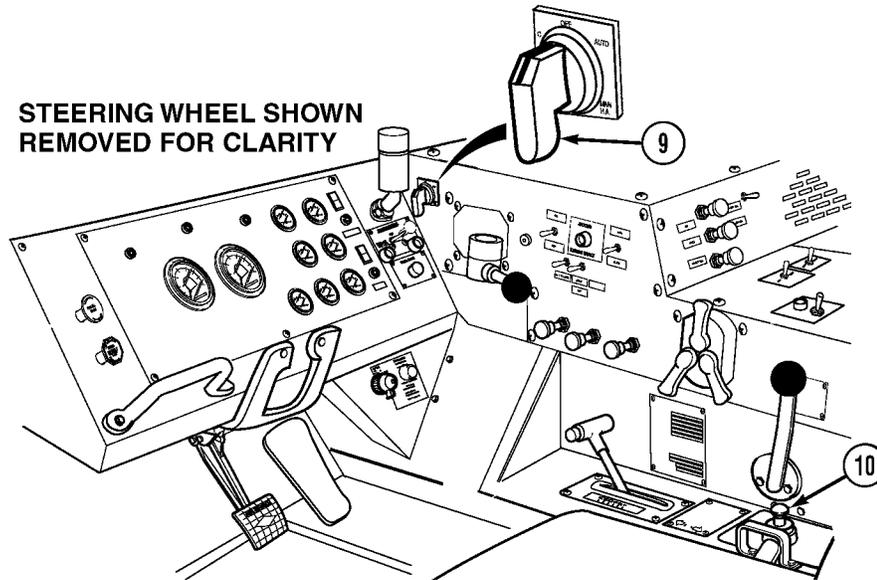

(11) Release the joystick (10).

CAUTION

Engine speed must be at idle before using hydraulic selector switch or damage to equipment may result.

(12) Turn the hydraulic selector switch (9) to MAN M.F. position.

(13) Move the joystick (10) to UNLOAD position until front of flatrack is completely seated on trailer.

(14) Release the joystick (10).

CAUTION

Do not use R (Reverse) to back up truck while hook arm is attached to flatrack or damage to LHS will occur.

(15) Turn the hydraulic selector switch (9) to MAN H.A. position.

Operating Instructions (Cont)

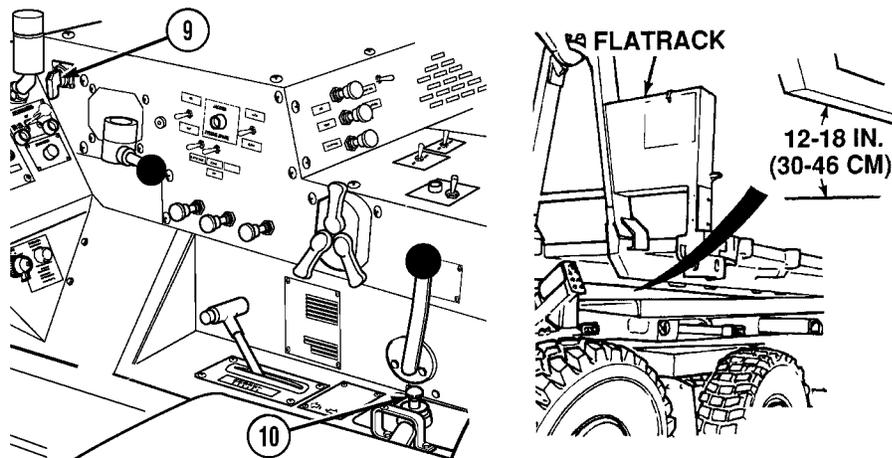

- (16) Move joystick (10) to LOAD position until front of flatrack is raised approximately 12 to 18 in. (30 to 46 cm) above trailer deck height.

CAUTION

Engine speed must be at idle before using hydraulic selector switch, or damage to equipment may result.

- (17) Turn the hydraulic selector switch (9) to MAN M.F. position.

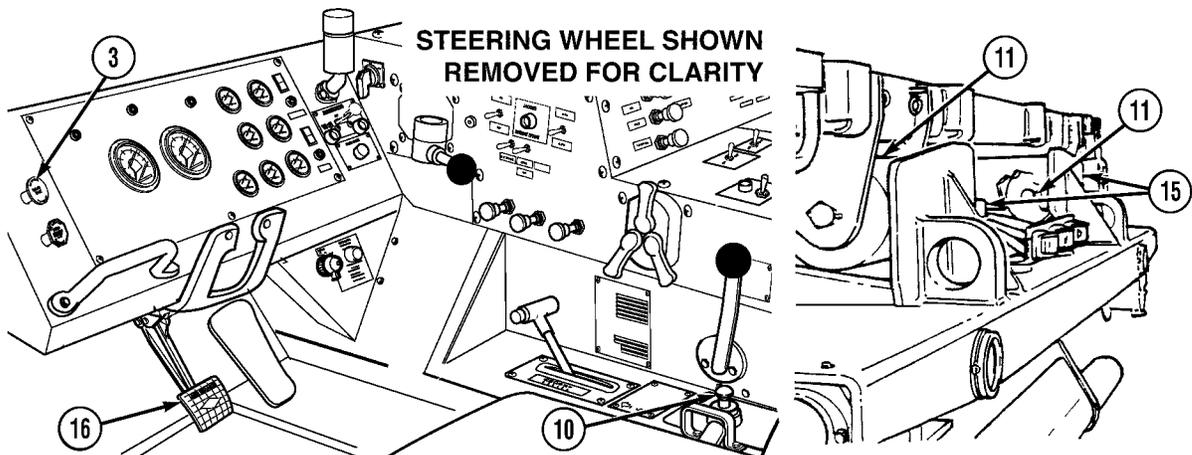

- (18) Move the joystick (10) to UNLOAD position until flatrack rollers (11) contact trailer stops (15) and front of flatrack guides are seated on trailer.
 (19) Release the joystick (10).
 (20) Inspect that rear flatrack rollers (11) on flatrack have contacted trailer stops (15).
 (21) Apply the service brake pedal (16).
 (22) Push in truck PARKING BRAKE control (3).

Operating Instructions (Cont)

2-9. LOAD HANDLING SYSTEM (LHS) (CONT).

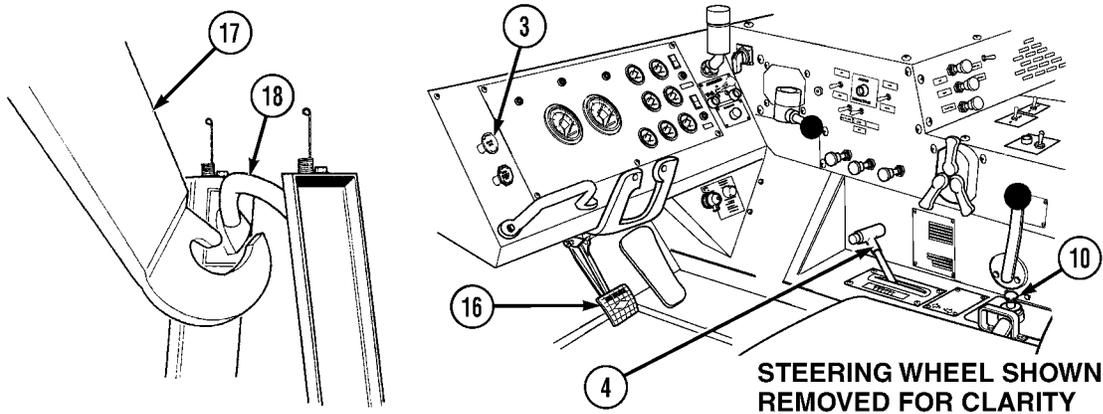

NOTE

It may be necessary to repeat the following steps several times to clear lift hook from hook bar.

- (23) Move the joystick (10) to UNLOAD position to allow top of lift hook (17) to clear hook bar (18).

NOTE

- Do not move truck forward more than 3 in. (76.2 mm) to prevent flatrack from pulling away from stops.
- LHS will only operate when transmission range selector is in N (Neutral).

- (24) Release the service brake pedal (16) and place transmission range selector (4) in D (Drive) and move truck forward approximately 3 in. (76.2 mm). Apply service brake pedal (16).
- (25) Move the joystick (10) to UNLOAD position to disengage lift hook (17) from hook bar (18).
- (26) Set the transmission range selector (4) to N (Neutral) and pull out PARKING BRAKE control (3).

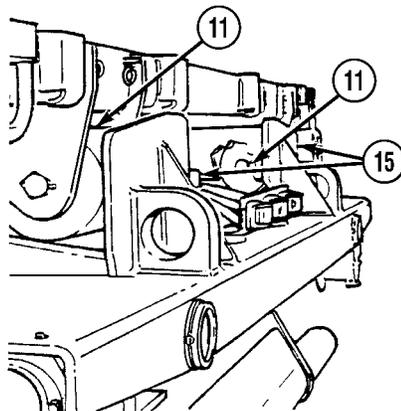

- (27) Inspect that rear flatrack rollers (11) have contacted trailer stops (15).

Operating Instructions (Cont)

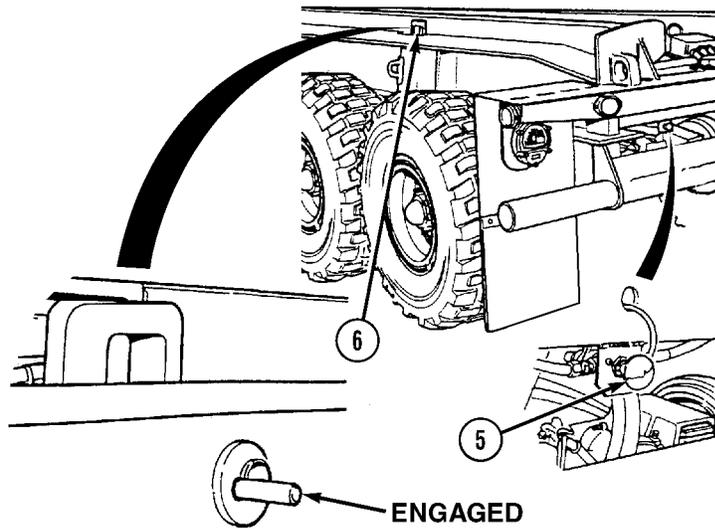

- (28) Pull knob (5) and engage flatrack locks (6).
- (29) Inspect that flatrack locks (6) are engaged.

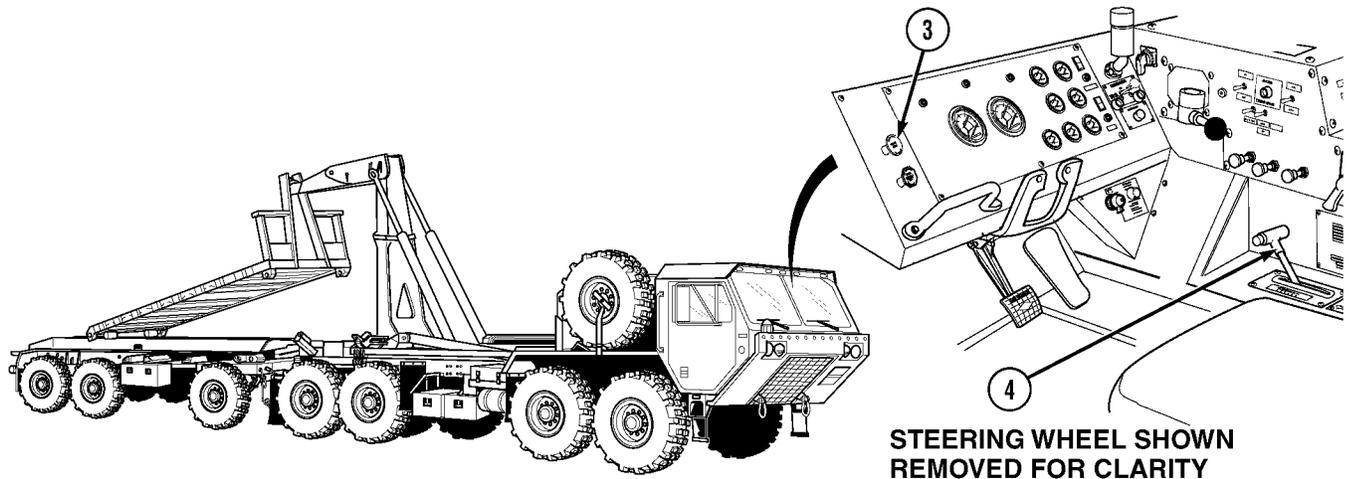

NOTE

LHS will only operate when transmission range selector is in N (Neutral).

- (30) Push in PARKING BRAKE control (3).
- (31) Set the transmission range selector (4) to D (Drive).
- (32) Move the truck forward approximately 5 ft. (1.5 m).
- (33) Pull out PARKING BRAKE control (6) and set the transmission range selector (4) to N (Neutral).

Operating Instructions (Cont)

2-9. LOAD HANDLING SYSTEM (LHS) (CONT).

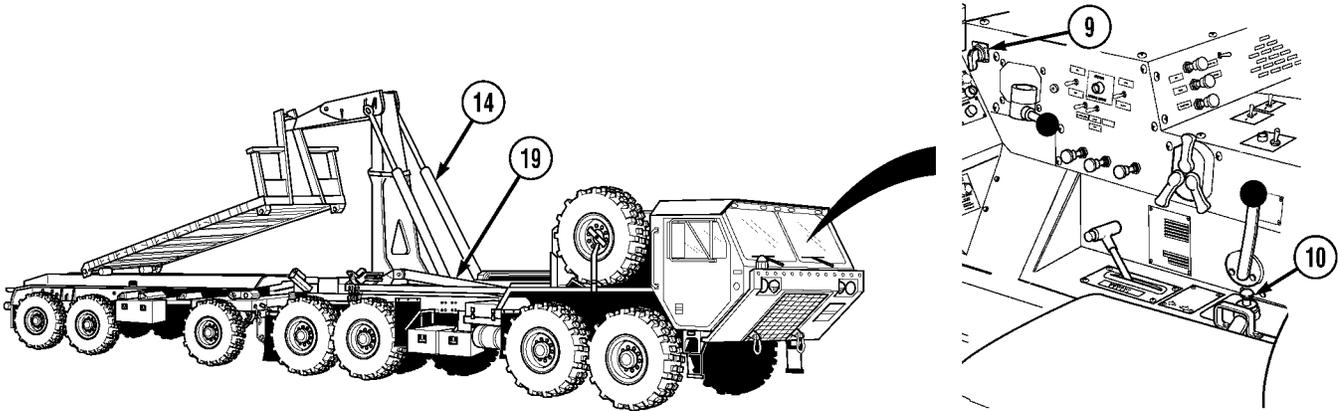

WARNING

Never drive with LHS NO TRANSIT indicator illuminated. An illuminated indicator means LHS is not fully stowed. The load could break loose causing serious injury or death to personnel.

NOTE

LHS OVER LOAD indicator will come on when main frame cylinders are fully extended or fully retracted and joystick is being activated.

- (34) Move the joystick (10) to LOAD position and hold in this position until main frame cylinders (19) are fully retracted.

CAUTION

Engine speed must be at idle before using hydraulic selector switch or damage to equipment may result.

- (35) Turn the hydraulic selector switch (9) to MAN H.A. position.

NOTE

LHS OVER LOAD indicator will come on when hook arm cylinders are fully extended or retracted and joystick is being activated.

- (36) Hold the joystick (10) in LOAD position until the hook arm cylinders (14) are fully retracted.

Operating Instructions (Cont)

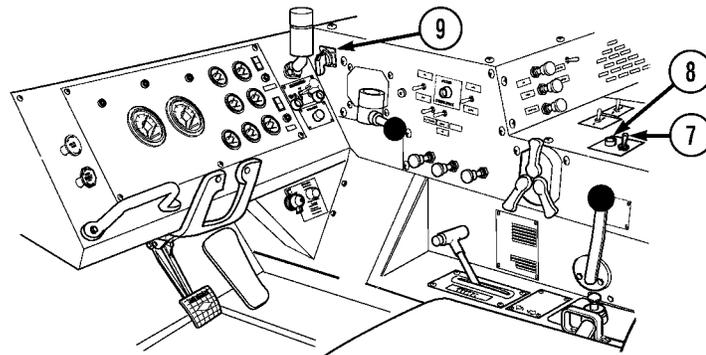

**STEERING WHEEL SHOWN
REMOVED FOR CLARITY**

CAUTION

Engine speed must be at idle before using hydraulic selector switch, or damage to equipment may result.

- (37) Turn the hydraulic selector switch (9) to MAN TRANS position.
- (38) Put PTO ENGAGE switch (7) in OFF position. Make sure indicator light (8) goes off.

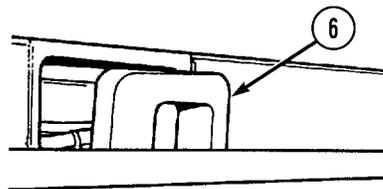

- (39) Inspect that flatrack is completely seated and load locks (6) are engaged.

Operating Instructions (Cont)

2-9. LOAD HANDLING SYSTEM (LHS) (CONT).

i. Removing Flatrack from Trailer in Manual Mode.

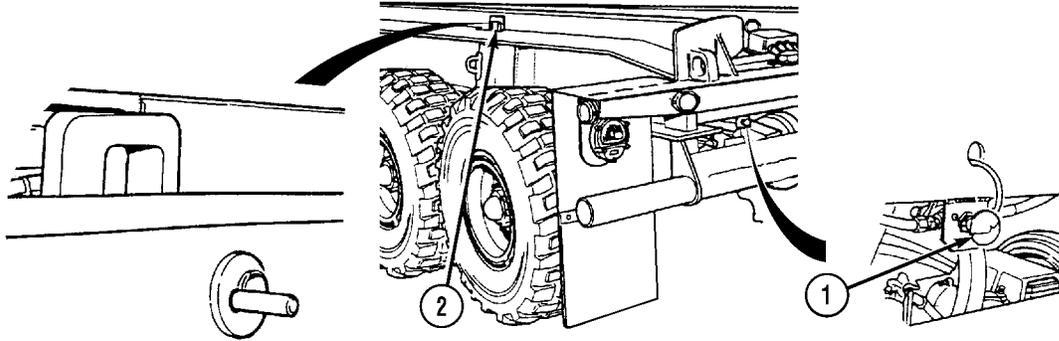

CAUTION

- There must be sufficient air pressure in trailer air system to retract flatrack locks or damage to flatrack lock can occur while attempting to remove flatrack from trailer. If not, use truck to charge trailer air system using trailer air charging hose. If air system cannot retract flatrack locks, use manual flatrack lock retract procedure (TM 9-2330-385-14).
- Ensure air lines and cables are properly stowed to prevent damage to equipment (TM 9-2330-385-14).
- Ensure that trailer drawbar is down against the ground during transfer operations or damage to equipment may result.

(1) Push the knob (1) on trailer to retract flatrack locks (2).

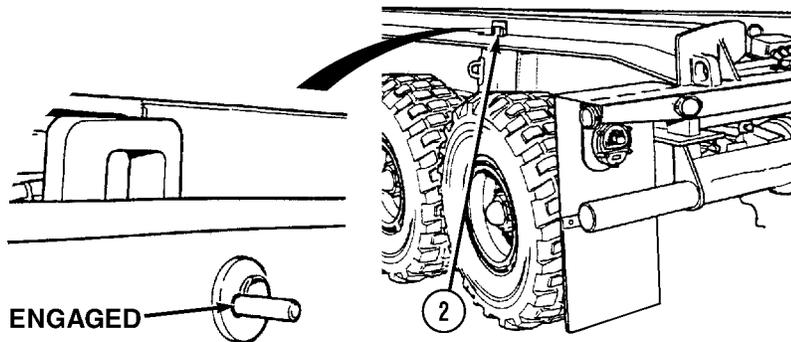

CAUTION

Ensure both flatrack locks are fully retracted or damage to equipment may result.

(2) Inspect that both flatrack locks (2) are fully retracted.

Operating Instructions (Cont)

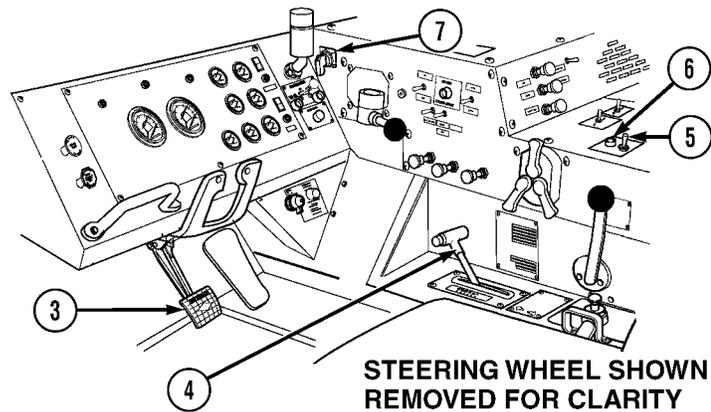

- (3) Back truck up in line with trailer and stop approximately 5 ft. (1.5 m) from trailer.
- (4) Apply the service brake pedal (3) and set transmission range selector (4) to N (Neutral).

WARNING

- Check for overhead power lines or other obstructions before attempting LHS operation. LHS reaches a height of 17 ft. 2 in. (5.23 m) with ISO container. Serious injury or death to personnel could result from contact with electrical power lines.
- Check ground conditions for firmness and extreme sideways inclination before picking up or off-loading a flatrack. Any ground instability beneath road wheels could cause serious injury or death to personnel.
- Prior to and during any load or unload cycle, all personnel should stay clear of LHS and flatrack or serious injury or death to personnel could result.

CAUTION

Engine speed must be at idle before using hydraulic selector switch or damage to equipment may result.

- (5) Put PTO ENGAGE switch (5) in ON position. Make sure indicator light (6) goes on.
- (6) Turn the hydraulic selector switch (7) to MAN H.A. position

Operating Instructions (Cont)

2-9. LOAD HANDLING SYSTEM (LHS) (CONT).

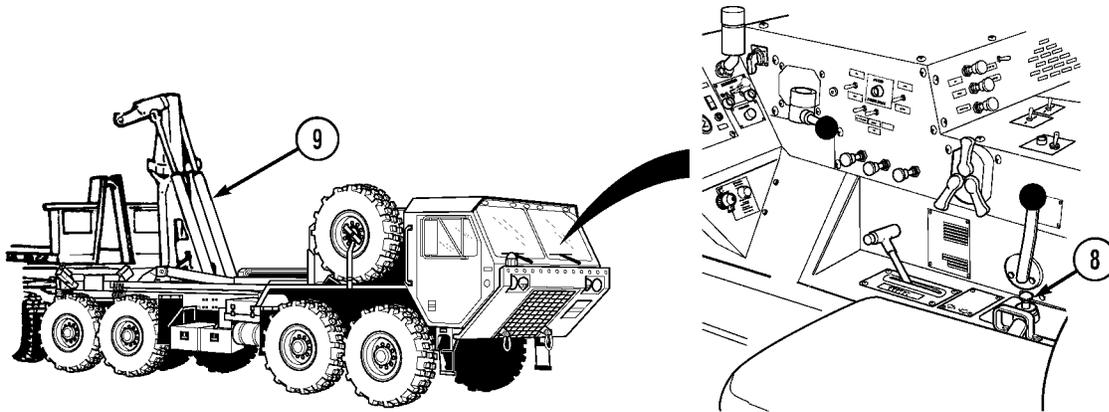

CAUTION

- To avoid equipment damage, visually check that hook arm cylinders have completed full extension.
- To avoid equipment damage, ensure that hook arm cylinders do not complete full extension while operating at engine speeds above idle.
- Ensure rail transport locking pins are disengaged before unloading flatrack. Rail transport locking pins are used for rail transport only. Failure to comply may result in damage to equipment.

NOTE

- LHS OVER LOAD indicator will come on when hook arm cylinders are fully extended and joystick is activated.
- The amount of time to load and unload is controlled by engine speed. Engine speed can be increased to 1,500 to maximum rpm to reduce loading and unloading times.

(7) Move the joystick (8) to UNLOAD position and hold until hook arm cylinders (9) are fully extended.

Operating Instructions (Cont)

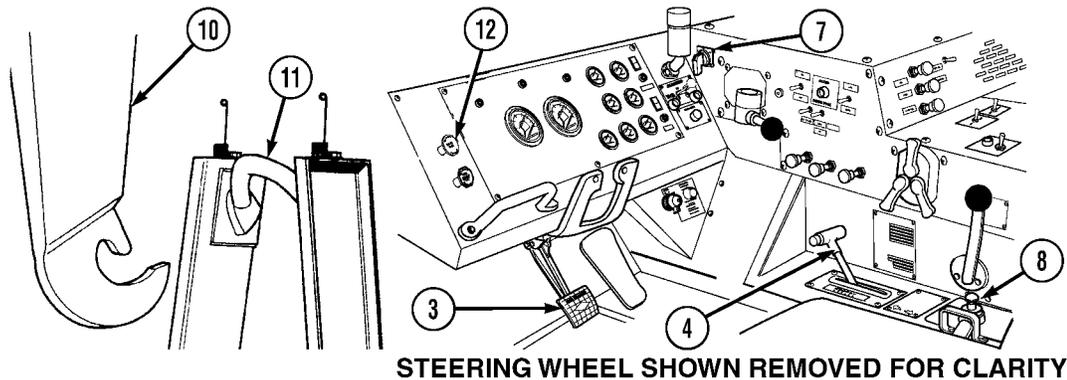

CAUTION

Engine speed must be at idle before using hydraulic selector switch, or damage to equipment may result.

- (8) Release the joystick (8) and turn hydraulic selector switch (7) to MAN M.F. position.
- (9) Hold joystick (8) in UNLOAD position until lift hook (10) has moved below level at flatrack hook bar (11).

NOTE

LHS will only operate when transmission range selector is in N (Neutral).

- (10) Set transmission range selector (4) to R (Reverse) and release service brake pedal (3). Back truck up until lift hook (10) contacts hook bar (11).
- (11) Pull out PARKING BRAKE control (12).

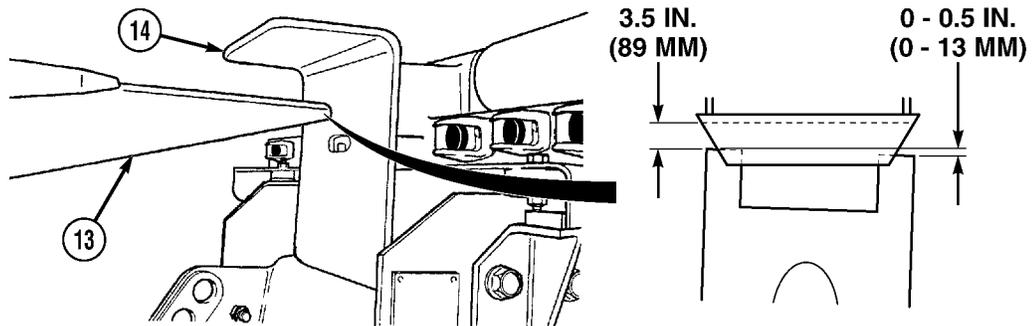

CAUTION

- Ensure that trailer drawbar is down against the ground or damage to equipment may result.
- Both of the trailer bumper points must be under the truck bumper stop flange and at least one of the bumper points must be within 3.5 in. (89 mm) of the bumper stop. The other trailer bumper point cannot exceed 0.5 in. (13 mm) difference in distance or flatrack will miss main rail guides and equipment damage may result.

- (12) Check that trailer bumper (13) is under flange of truck bumper stop (14).

Operating Instructions (Cont)

2-9. LOAD HANDLING SYSTEM (LHS) (CONT).

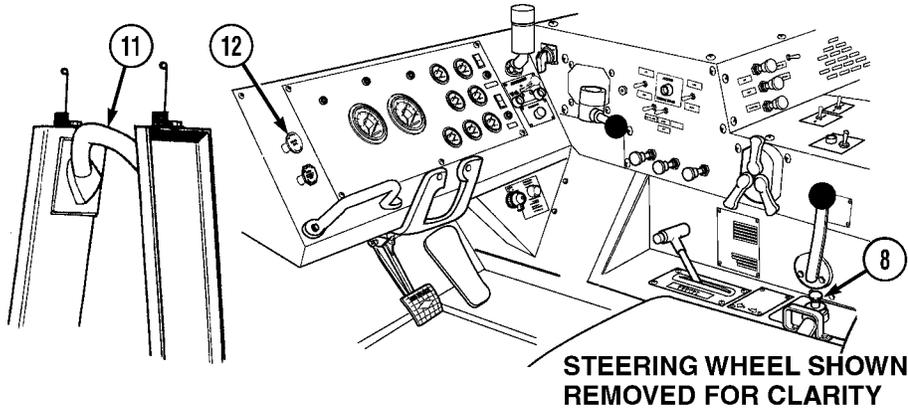

- (13) Push in PARKING BRAKE control (12) and move joystick (8) to LOAD position and engage hook bar (11).

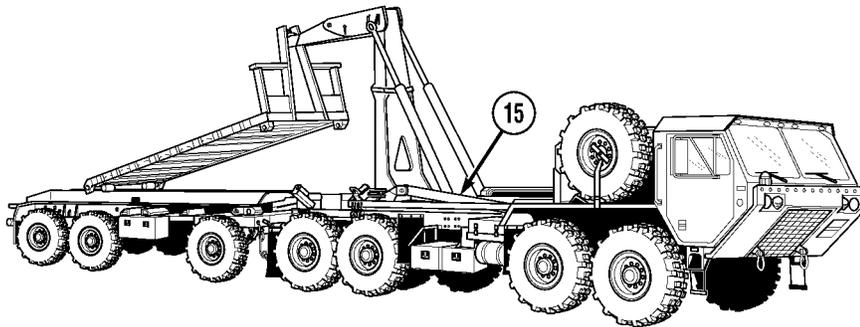

CAUTION

- To avoid equipment damage, visually check that hook arm cylinders have completed full movement.
- To avoid equipment damage, ensure that hook arm cylinders do not complete full movement while operating at engine speeds above idle.

NOTE

LHS OVER LOAD indicator will come on when main frame cylinders are fully retracted and joystick is being activated.

- (14) Continue to load in MAN M.F. mode until the main frame cylinders (15) are fully retracted.

Operating Instructions (Cont)

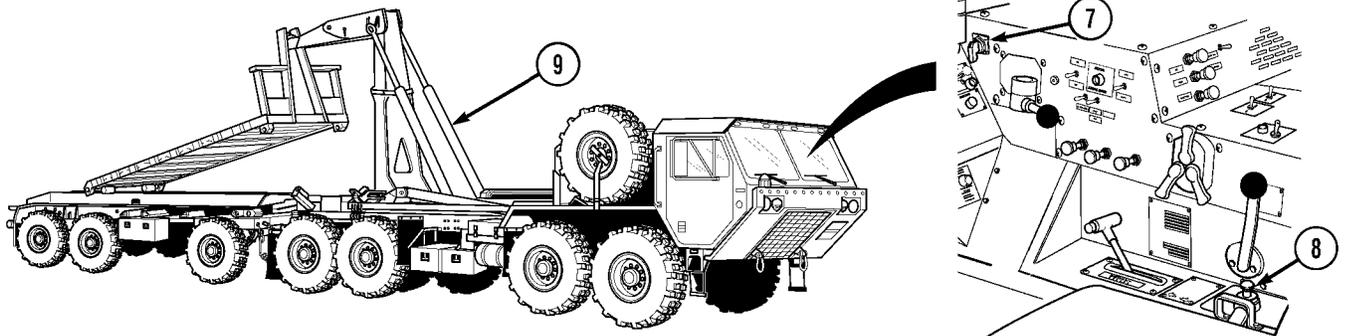

CAUTION

Engine speed must be at idle before using hydraulic selector switch or damage to equipment may result.

- (15) Turn the hydraulic selector switch (7) to MAN H.A. position.

WARNING

Never drive with LHS NO TRANSIT indicator illuminated. An illuminated indicator means LHS is not fully stowed. The load could break loose causing serious personal injury or death to personnel.

NOTE

LHS OVER LOAD indicator will come on when hook arm cylinders are fully retracted and joystick is being activated.

- (16) Hold the joystick (8) in LOAD position until hook arm cylinders (9) are fully retracted.

Operating Instructions (Cont)

2-9. LOAD HANDLING SYSTEM (LHS) (CONT).

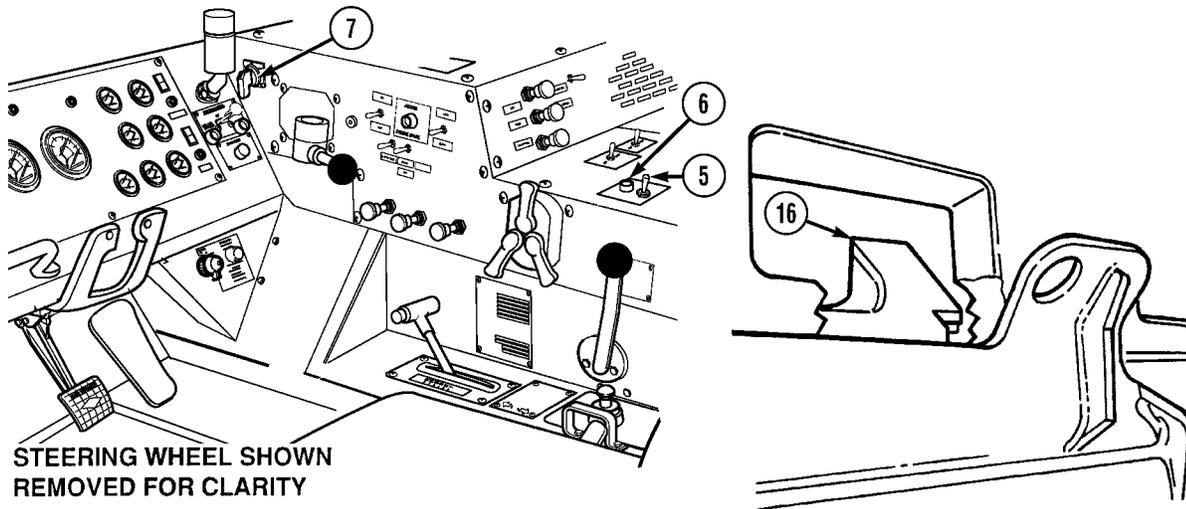

CAUTION

- Engine speed must be at idle before using hydraulic selector switch or damage to equipment may result.
- Hydraulic selector switch must remain in MAN TRANS position while truck is traveling or damage to equipment may result.

- (17) Turn hydraulic selector switch (7) to MAN TRANS position.
(18) Put PTO ENGAGE switch (5) in OFF position. Make sure indicator light (6) goes off.

NOTE

If load locks do not engage, raise flatrack slightly and lower again. Flatrack should seat completely and engage load locks.

- (19) Inspect that load locks (16) are engaged and flatrack is fully loaded on truck.

Operating Instructions (Cont)

j. Loading Flatrack with or without Rollers from Dock Area or Bay (Not to Exceed Truck Chassis Height).

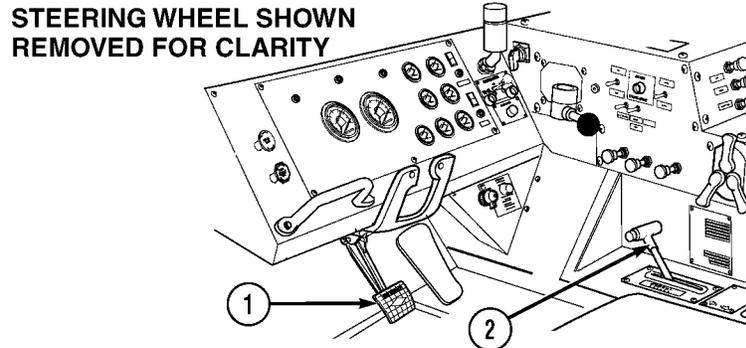

CAUTION

Do not back up to loading docks in which the height of the dock exceeds the height of bottom of the flatrack on the truck, or damage to equipment may result.

- (1) Position truck approximately 5 ft. (1.5 m) from front of flatrack.
- (2) Apply the service brake pedal (1) and set transmission range selector (2) to N (Neutral).

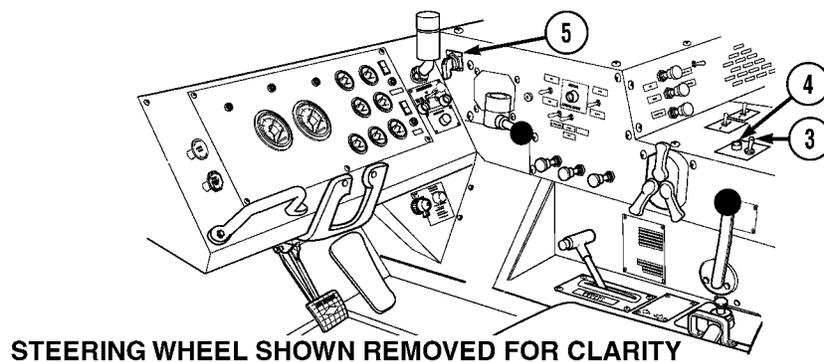

CAUTION

Set engine speed at idle before selecting LHS mode or damage to equipment may result.

NOTE

When loading or unloading flatrack from dock or bay area, presence of rollers on rear of flatrack will aid in operation. Procedure can be accomplished using hydraulic selector switch in AUTO position or MAN H.A. position and MAN M.F. position. Refer to Para 2-9 d. and e. for movement of LHS in MANUAL mode.

- (3) Put PTO ENGAGE switch (3) in ON position. Make sure indicator light (4) comes on.
- (4) Turn the hydraulic selector switch (5) to MAN M.F., MAN H.A., or AUTO position as required.

Operating Instructions (Cont)

2-9. LOAD HANDLING SYSTEM (LHS) (CONT).

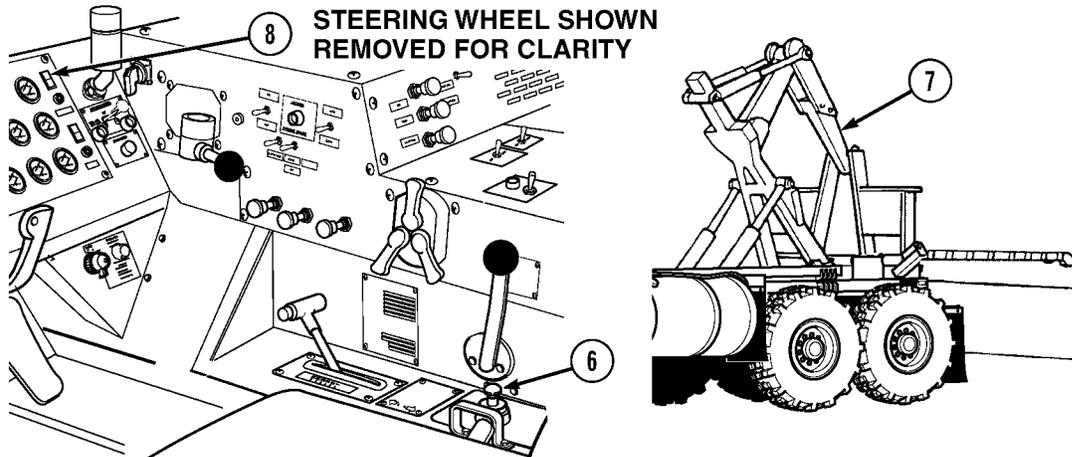

WARNING

- Check for overhead power lines or other obstructions before attempting LHS operation. LHS reaches a height of 17 ft. 2 in. (5.23 m) with ISO container. Serious injury or death to personnel could result from contact with electrical power lines.
- Check ground conditions for firmness and extreme sideways inclination before picking up or off-loading a flatrack. Any ground instability beneath road wheels could cause serious injury or death to personnel.
- Prior to and during any load or unload cycle, all personnel should stay clear of LHS and flatrack or serious injury or death to personnel could result.

(5) Move the joystick (6) to UNLOAD position. Lift hook (7) will raise and begin to move rearwards. LHS NO TRANSIT indicator (8) will illuminate to indicate load locks have been cleared.

Operating Instructions (Cont)

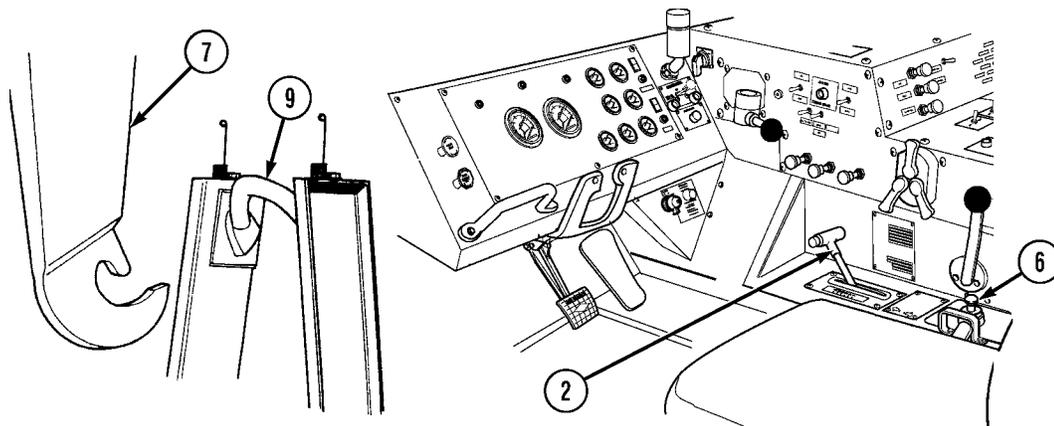

**STEERING WHEEL SHOWN
REMOVED FOR CLARITY**

NOTE

LHS will only operate when transmission range selector is in N (Neutral).

- (6) When the lift hook (7) has moved below level of flatrack hook bar (9), set transmission range selector (2) to R (Reverse) and back truck to flatrack while aligning truck to flatrack as straight as possible (± 10 degrees) with lift hook (7) in middle of hook bar (9) until lift hook contacts hook bar.
- (7) Set transmission range selector (2) to N (Neutral).

CAUTION

Load must be evenly distributed on the pallet. Uneven load distribution may cause LHS OVER LOAD indicator to give false signals and cause LHS to operate incorrectly. Damage to equipment may result.

NOTE

Slight misalignment (up to 10 degrees) will not prevent hook from attaching to flatrack.

- (8) Move the joystick (6) to LOAD, engaging lift hook (7) in hook bar (9) and lift slightly.

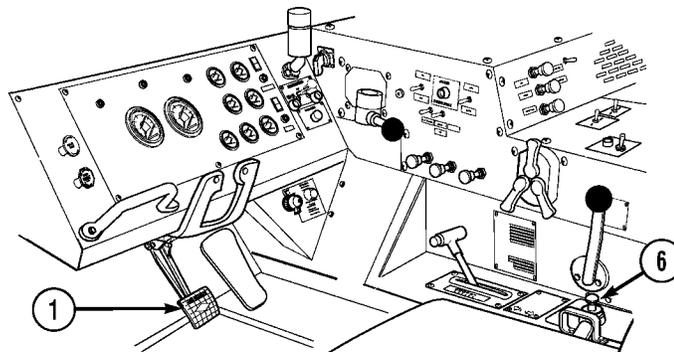

**STEERING WHEEL SHOWN
REMOVED FOR CLARITY**

CAUTION

Flatrack must be in contact with rear roller assembly on rear of truck before flatrack rear edge comes off loading bay or dock. Failure to contact rear roller assembly will overload LHS components and may damage truck.

- (9) Release the service brake pedal (1) and allow truck to be pulled toward dock or bay until approximately 6 in. (15 cm) away.
- (10) Apply the service brake pedal (1) and move joystick (6) to LOAD position.

Operating Instructions (Cont)

2-9. LOAD HANDLING SYSTEM (LHS) (CONT).

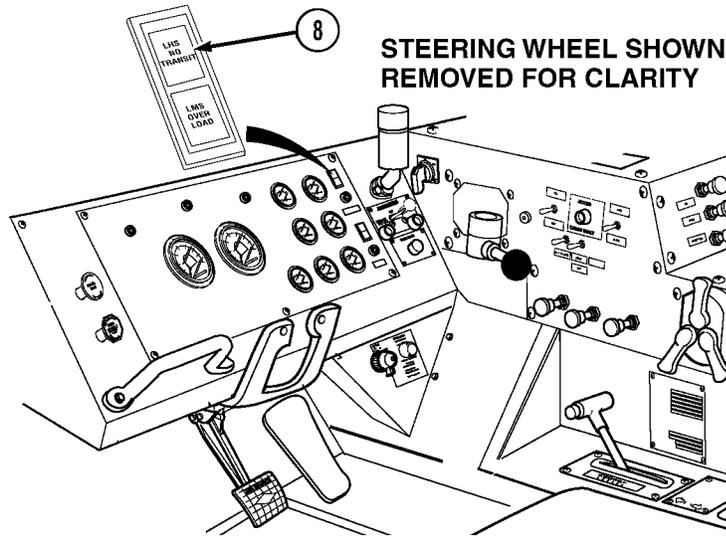

CAUTION

- If LHS OVER LOAD indicator illuminates but loading operation continues, operator is cautioned that LHS is nearing its maximum capacity. In this situation, operator should determine if payload is evenly distributed on flatrack or if flatrack load exceeds 25,000 lbs. (11 340 kg). If any of these conditions exist, operator must redistribute or reduce payload or damage to equipment may result.
- If LHS OVER LOAD indicator illuminates, normal operation has stopped. Return load to original position and redistribute or reduce payload weight or damage to equipment may result.
- Load must be evenly distributed on the pallet. Uneven load distribution may cause LHS OVER LOAD indicator to give false signals and cause LHS to operate incorrectly. Damage to equipment may result.

(11) Continue loading until LHS NO TRANSIT indicator (8) goes off, indicating LHS load locks have engaged.

Operating Instructions (Cont)

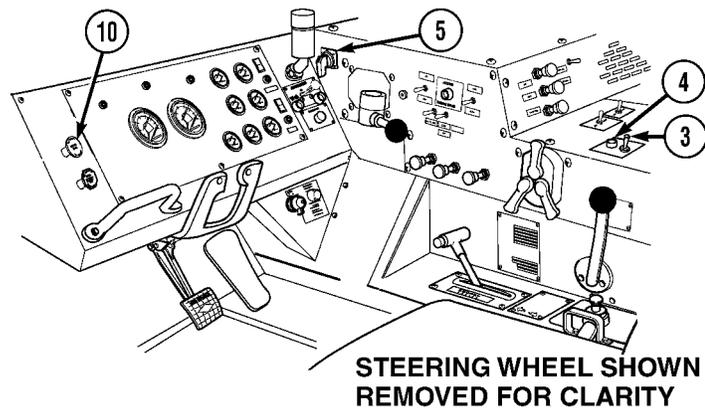

CAUTION

Engine speed must be at idle before using hydraulic selector switch or damage to equipment may result.

- (12) Turn the hydraulic selector switch (5) to OFF or MAN TRANS position as required.
- (13) Pull out PARKING BRAKE control (10).
- (14) Put PTO ENGAGE switch (3) in OFF position. Make sure indicator light (4) goes off.

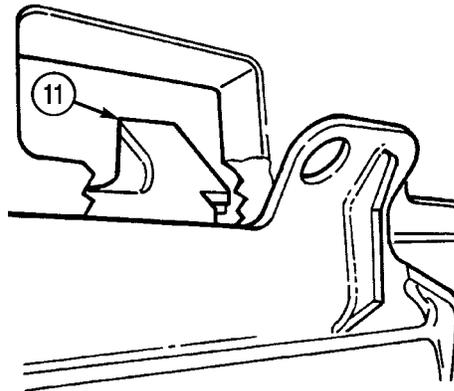

NOTE

If load locks do not engage raise flatrack slightly and lower again. Flatrack should seat fully and engage load locks.

- (15) Inspect that load locks (11) are engaged and flatrack is fully seated on truck.

Operating Instructions (Cont)

2-9. LOAD HANDLING SYSTEM (LHS) (CONT).

k. Unloading Flatrack with or without Rollers onto Dock Area or Bay (Not Exceeding Truck Chassis Height).

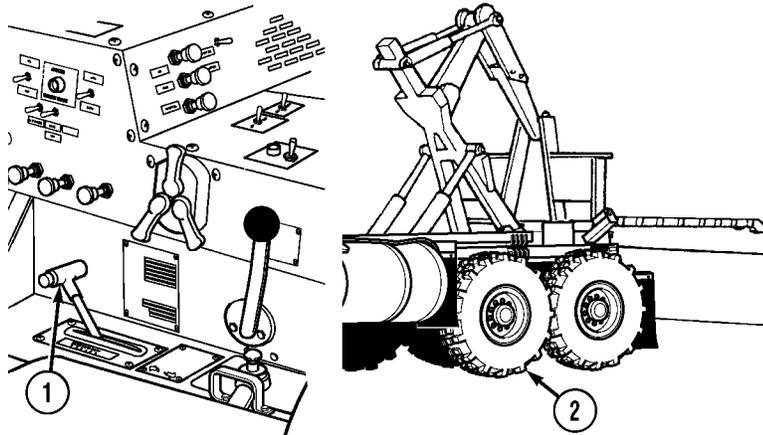

CAUTION

Do not back up to loading docks in which the height of the dock exceeds the height of bottom of the flatrack on the truck, or damage to equipment may result.

NOTE

When loading or unloading flatrack from dock or bay area, presence of rollers on rear of flatrack will aid in operation. Procedure can be accomplished using hydraulic selector switch in AUTO position or MAN H.A. position and MAN M.F. position. Refer to Para 2-9 d. and e. for movement of LHS in manual mode.

- (1) Set the transmission range selector (1) to R (Reverse) and back truck to dock. Stop truck when rear tires (2) are approximately 6 in. (15 cm) from dock.

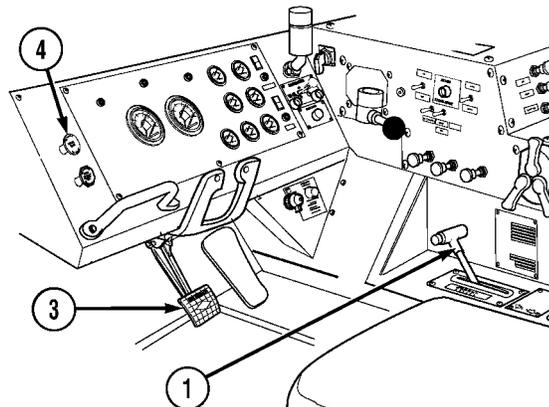
Operating Instructions (Cont)

**STEERING WHEEL SHOWN
REMOVED FOR CLARITY**

WARNING

- Check for overhead power lines or other obstructions before attempting LHS operation. LHS reaches a height of 17 ft. 2 in. (5.23 m) with ISO container. Serious injury or death to personnel could result from contact with electrical power lines.
 - Check ground conditions for firmness and extreme sideways inclination before picking up or off-loading a flatrack. Any ground instability beneath road wheels could cause serious injury or death to personnel.
 - Prior to and during any load or unload cycle, all personnel should stay clear of LHS and flatrack or serious injury or death to personnel could result.
- (2) Apply the service brake pedal (3) and set transmission range selector (1) to N (Neutral) and pull out PARKING BRAKE control (4).

Operating Instructions (Cont)

2-9. LOAD HANDLING SYSTEM (LHS) (CONT).

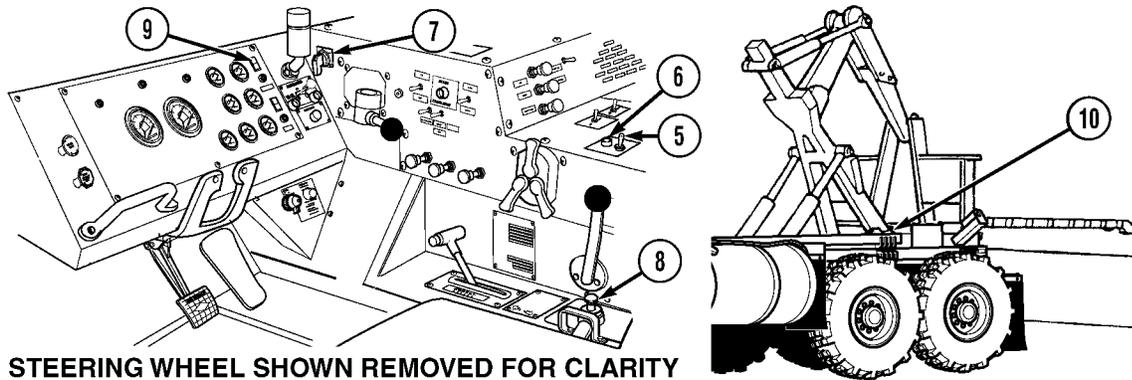

CAUTION

- Engine speed must be at idle before using hydraulic selector switch or damage to equipment may result.
- Ensure rail transport locking pins are disengaged before unloading flatrack. Rail transport locking pins are used for rail transport only. Failure to comply may result in damage to equipment.

- (3) Put PTO ENGAGE switch (5) in ON position. Make sure indicator light (6) comes on.
 (4) Turn the hydraulic selector switch (7) to AUTO position or MAN H.A. position.

NOTE

- The amount of time to load and unload is controlled by engine speed. Engine speed can be increased to 1,500 to maximum rpm to reduce loading and unloading times.
 - LHS will only operate when transmission range selector is in N (Neutral).
- (5) Move joystick (8) to UNLOAD position. Flatrack will raise and begin to move rearwards. LHS NO TRANSIT indicator (9) will illuminate to indicate load locks (10) have been cleared.

CAUTION

- Do not back truck to push flatrack onto dock or bay. Damage to equipment will result.
 - Do not use R (Reverse) to back up truck while hook arm is attached to flatrack or damage to LHS will occur.
- (6) As load continues rearward, flatrack will contact dock and flatrack will be pushed rearward onto dock or bay.
 (7) Release the joystick (8).

Operating Instructions (Cont)

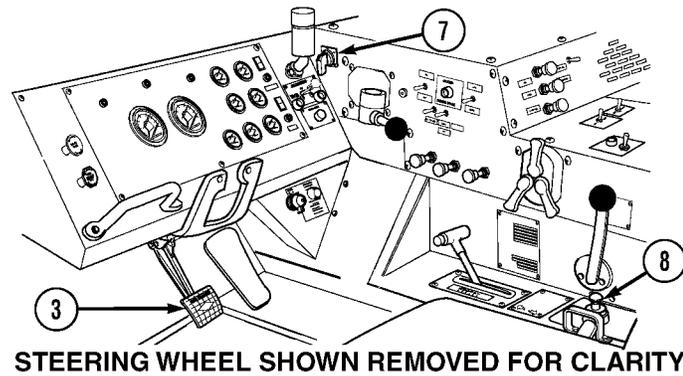

STEERING WHEEL SHOWN REMOVED FOR CLARITY

CAUTION

Engine speed must be at idle before using hydraulic selector switch or damage to equipment may result.

- (8) Turn the hydraulic selector switch (7) to MAN H.A. position.
- (9) Move joystick (8) to LOAD position until front of flatrack is raised approximately 15 in. (38 cm) above dock or bay.
- (10) Turn the hydraulic selector switch (7) to MAN M.F. position.
- (11) Move the joystick (8) to UNLOAD position until flatrack is positioned on dock or bay.
- (12) Release the joystick (8).

CAUTION

Before moving truck, ensure hook is not engaged to hook bar or damage to equipment may result.

- (13) Apply the service brake pedal (3).

Operating Instructions (Cont)

2-9. LOAD HANDLING SYSTEM (LHS) (CONT).

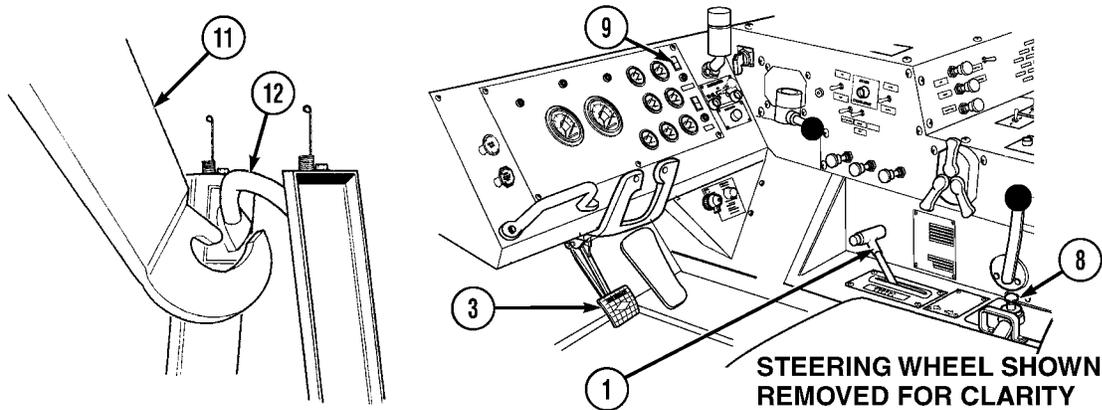

NOTE

It may be necessary to repeat steps (14) through (18) several times to clear hook arm from hook bar.

(14) Move the joystick (8) to LOAD position to allow top of lift hook (11) to clear hook bar (12).

NOTE

- Do not move truck forward more than 3 in. (76.2 mm) to prevent flatrack from pulling over edge of dock.
- LHS will only operate when transmission range selector is in N (Neutral).

- (15) Release the service brake pedal (3) and place transmission range selector (1) in D (Drive).
 (16) Move truck forward approximately 3 in. (76.2 mm) and apply service brake pedal (3).
 (17) Place transmission range selector (1) in N (Neutral).
 (18) Move the joystick (8) to UNLOAD position to disengage hook (11) from hook bar (12).
 (19) Place transmission range selector (1) in D (Drive), release the service brake pedal (3) and move the truck forward approximately 5 ft. (1.5 m).
 (20) Apply service brake pedal (3).
 (21) Place transmission range selector (1) in N (Neutral).
 (22) Move joystick (8) to LOAD position until LHS NO TRANSIT indicator (9) goes off, indicating LHS is completely stowed.

Operating Instructions (Cont)

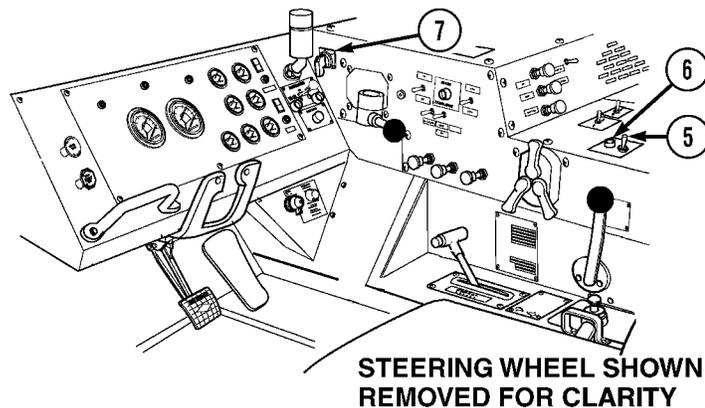

CAUTION

Engine speed must be at idle before using hydraulic selector switch or damage to equipment may result.

- (23) Turn hydraulic selector switch (7) to OFF position.
- (24) Put PTO ENGAGE switch (5) in OFF position. Make sure indicator light (6) goes off.

2-10. CONFIGURING FOR OVER-THE-ROAD OPERATIONS.

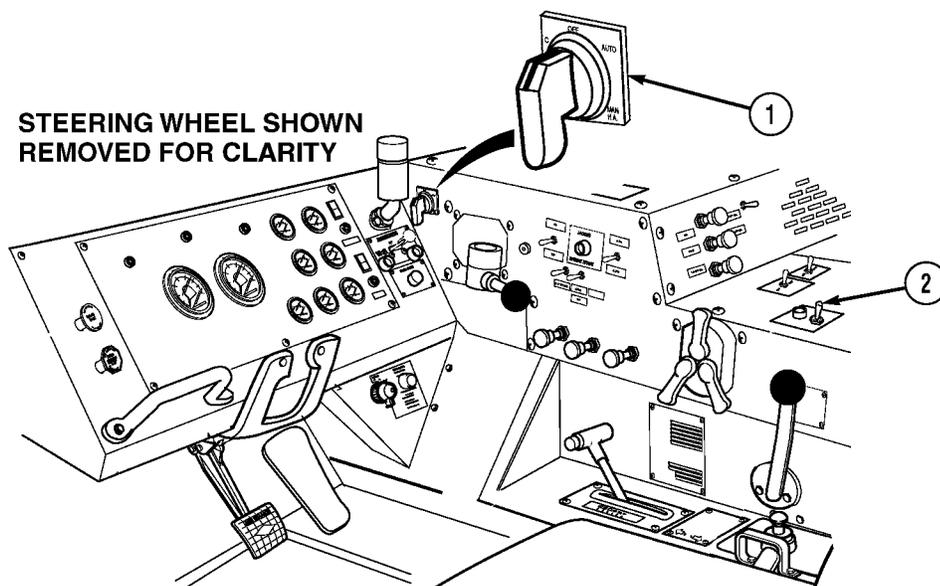

Before starting an over-the-road operation make sure that the hydraulic selector switch (1) and the PTO ENGAGE switch (2) are in OFF position. If AUTO circuits have failed and manual load operations were used, set hydraulic selector switch (1) to MAN TRANS position.

Operating Instructions (Cont)

2-10.1 CONTAINER HANDLING UNIT (CHU).

a. Preparation for Container Mode.

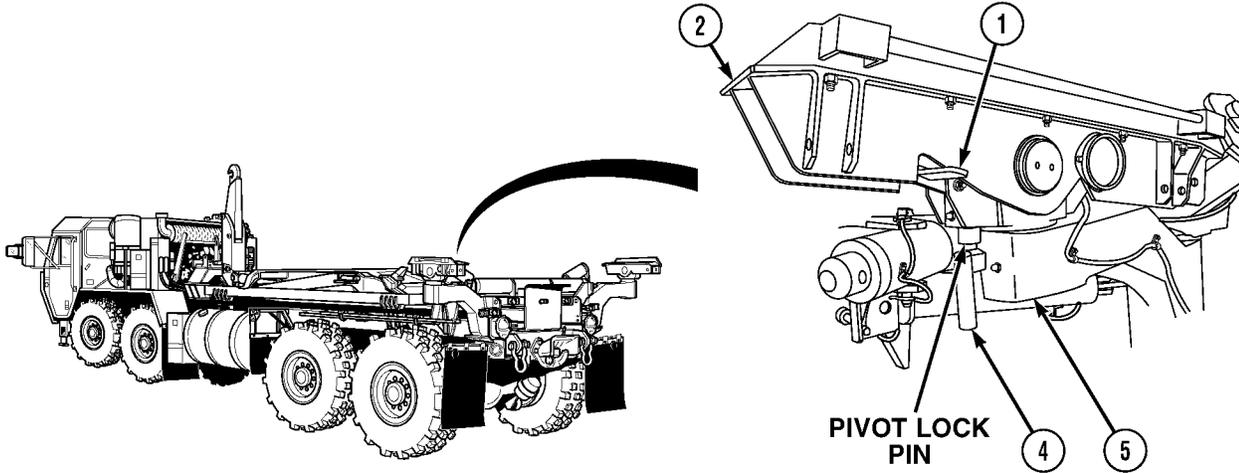

NOTE

There are two strut and slider assemblies. Left side is shown.

- (1) Pull down pivot lock pin handle (1) and rotate rear slider (2) over tire until pivot lock pin locks.
- (2) Lift rear of slider (2) and, using handle (3), rotate slider arm (4) outward.

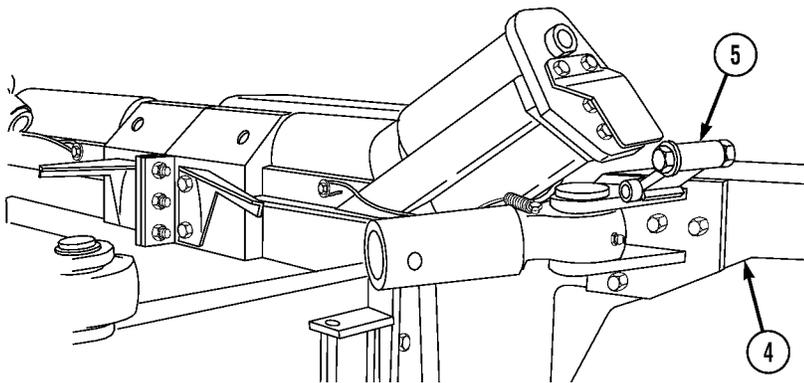

- (3) Rotate flip lock (5) up to hold slider arm (4). Release slider arm.

Operating Instructions (Cont)

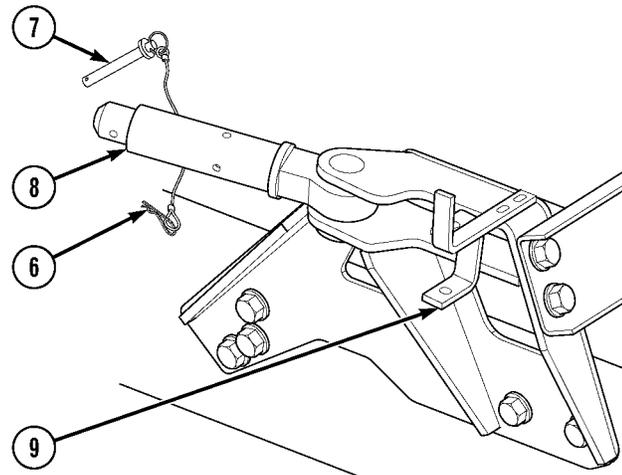

- (4) Remove lock pin (6) and pin (7) from long strut (8) and strut bracket (9).

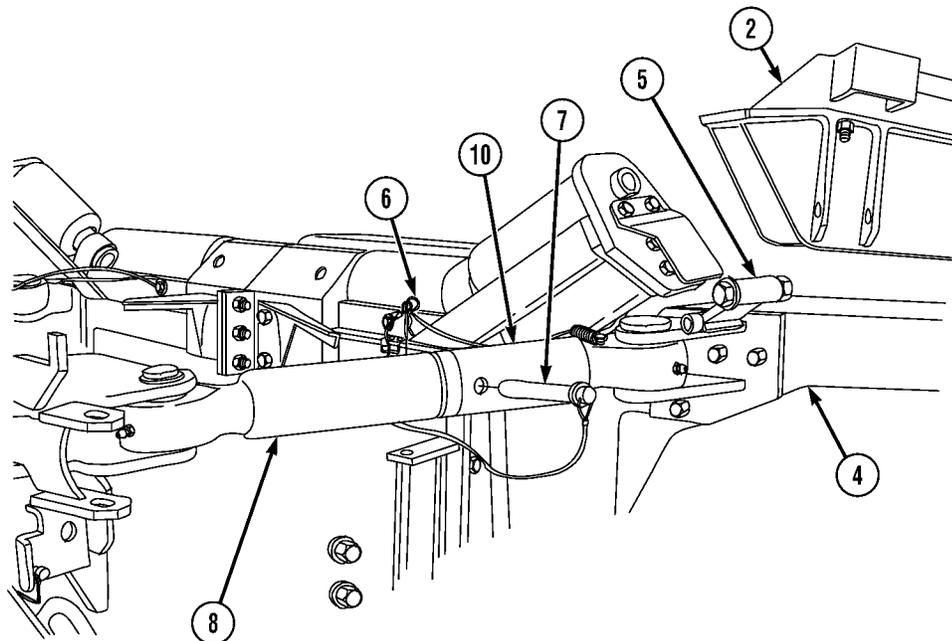
**WARNING**

Make sure fingers and hands are not between strut front and rear halves. Fingers and hands could become pinched during assembly, causing injury to personnel.

- (5) Align long strut (8) with short strut (10).
 (6) Rotate slider arm (4) out with handle and disengage flip lock (5) by rotating it down.
 (7) Position long strut (8) into short strut (10), install pin (7), and lock pin (6). Make sure slider (2) is in straight ahead position.
 (8) Repeat steps (1) through (7) for right side.

Operating Instructions (Cont)

2-10.1 CONTAINER HANDLING UNIT (CHU) (CONT).

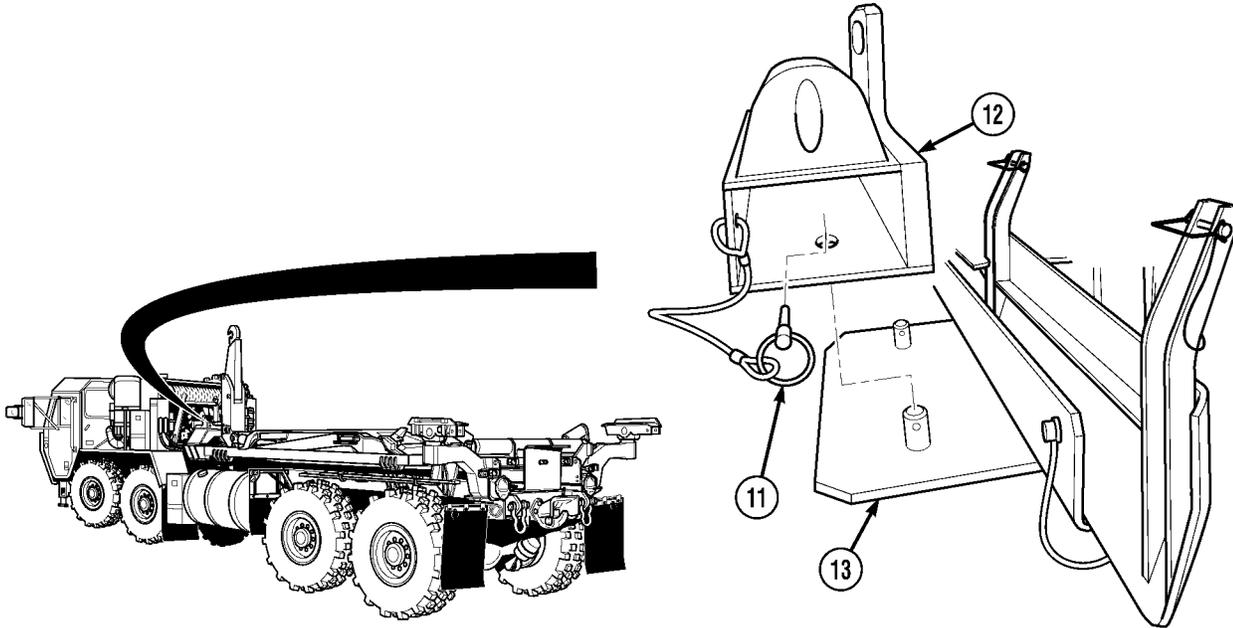

NOTE

- There are two bumper supports and container guides. Left side is shown.
- Bumper support is in container mode when bumper support is positioned completely over bracket, toward rear of truck.

- (9) Remove lock pin (11) from bumper support (12).
 (10) Remove bumper support (12) from stowage tray (13).

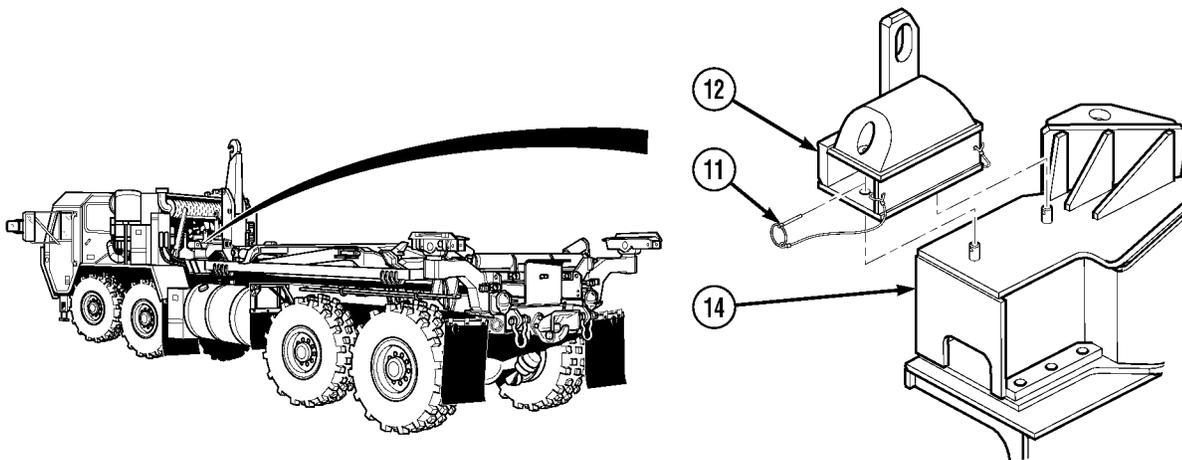

- (11) Install bumper support (12) on front container support (14) and install lock pin (11).

Operating Instructions (Cont)

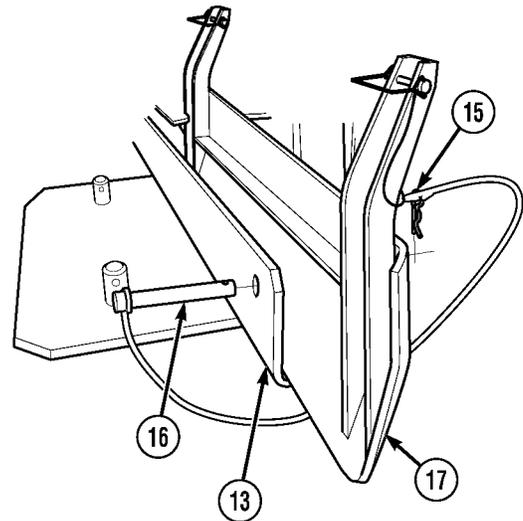
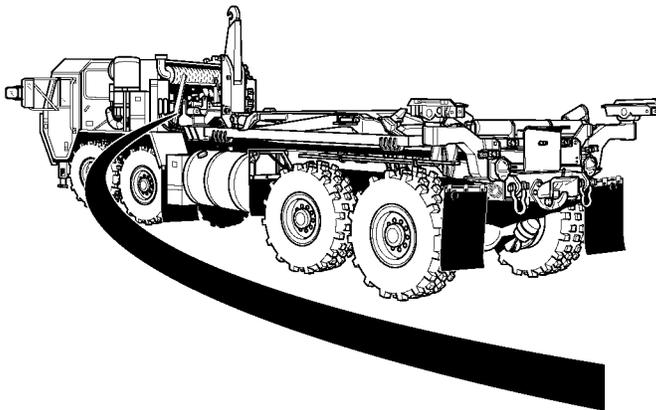

- (12) Remove lock pin (15), pin (16), and container guide (17) from storage tray (13).
 (13) Install pin (16) and lock pin (15) in storage tray (13).

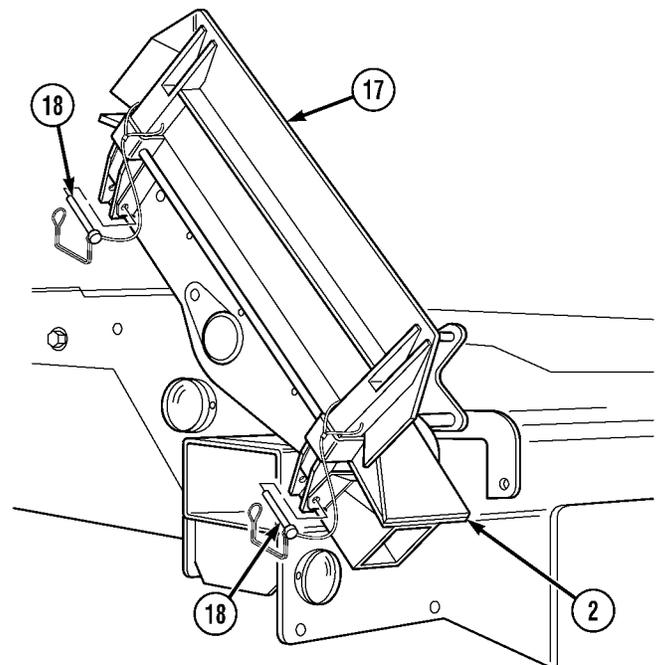
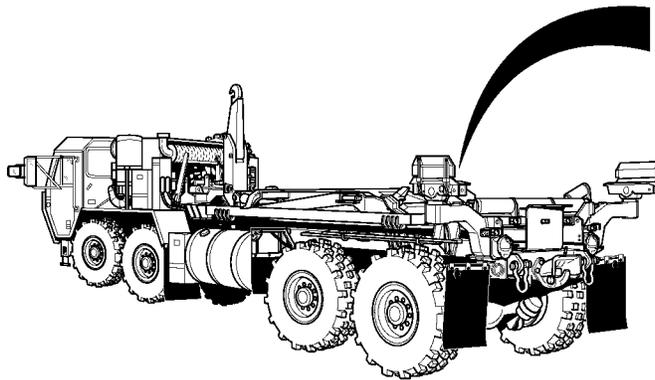
**WARNING**

Hands may get pinched when installing container guide into slider. Hold container guides by outer edges of plate to avoid pinching between container guides and slider. Failure to comply may result in injury to personnel.

- (14) Remove two lock pins (18) from container guide (17).
 (15) Position container guide (17) in slider (2) and install two lock pins (18).
 (16) Repeat steps (9) through (15) for right side.

Operating Instructions (Cont)

2-10.1 CONTAINER HANDLING UNIT (CHU) (CONT).

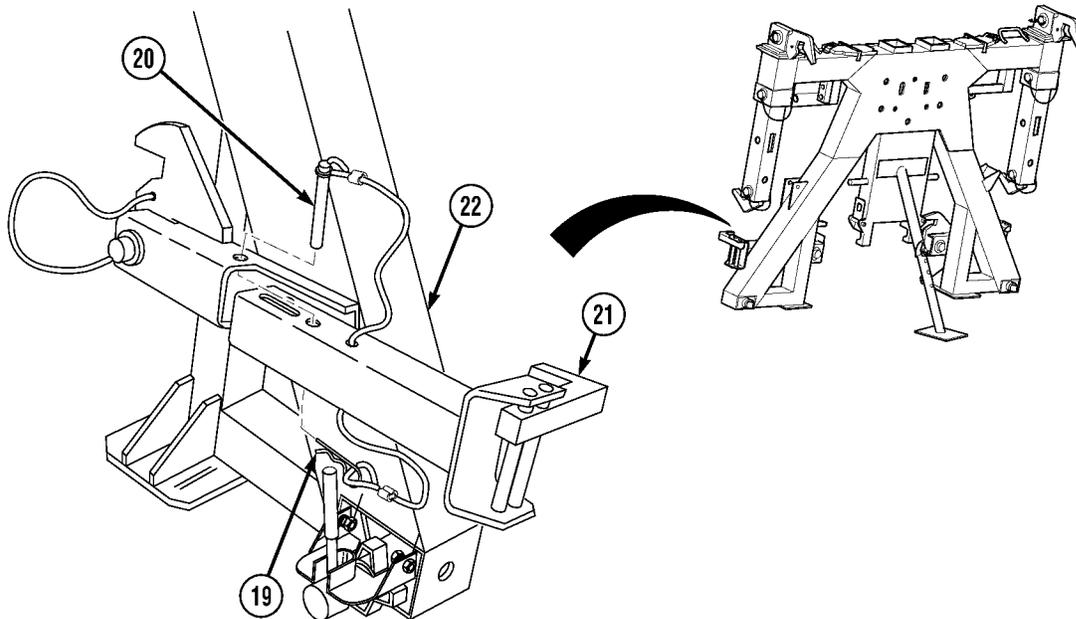

NOTE

There are two rear container locks on front lift adapter. Left side is shown.

- (17) Remove lock pin (19), pin (20), and rear container lock (21) from stowage bracket on front lift adapter (22).

Operating Instructions (Cont)

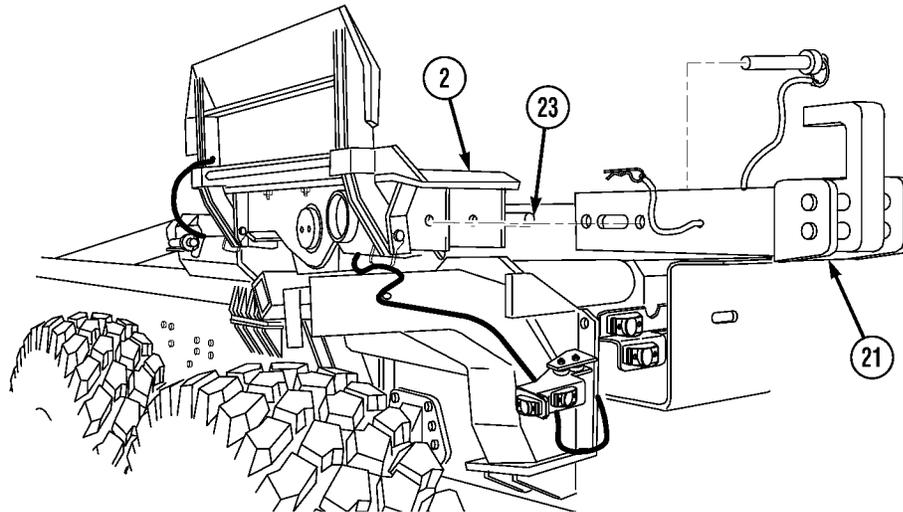

- (18) Turn lock handle (23) on slider (2) forward to unlock position.

NOTE

Hook in rear container lock must face up.

- (19) Position rear container lock (21) in opening of slider (2).

NOTE

Make sure rear container lock pivot pin is in slot of rear container lock.

- (20) Turn lock handle (23) on slider (2) back to locked position.

Operating Instructions (Cont)

2-10.1 CONTAINER HANDLING UNIT (CHU) (CONT).

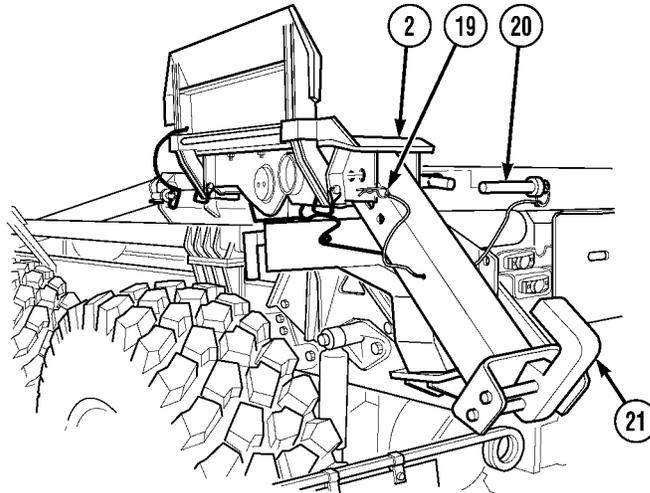

- (21) Pull rear container lock (21) out to ready mode (down position).

NOTE

Pin is installed in hole farthest back on slider for ready mode.

- (22) Install pin (20) and lock pin (19) in slider (2) and rear container lock (21).
- (23) Repeat steps (17) through (22) for right side.

Operating Instructions (Cont)

b. Returning to Flatrack Mode.

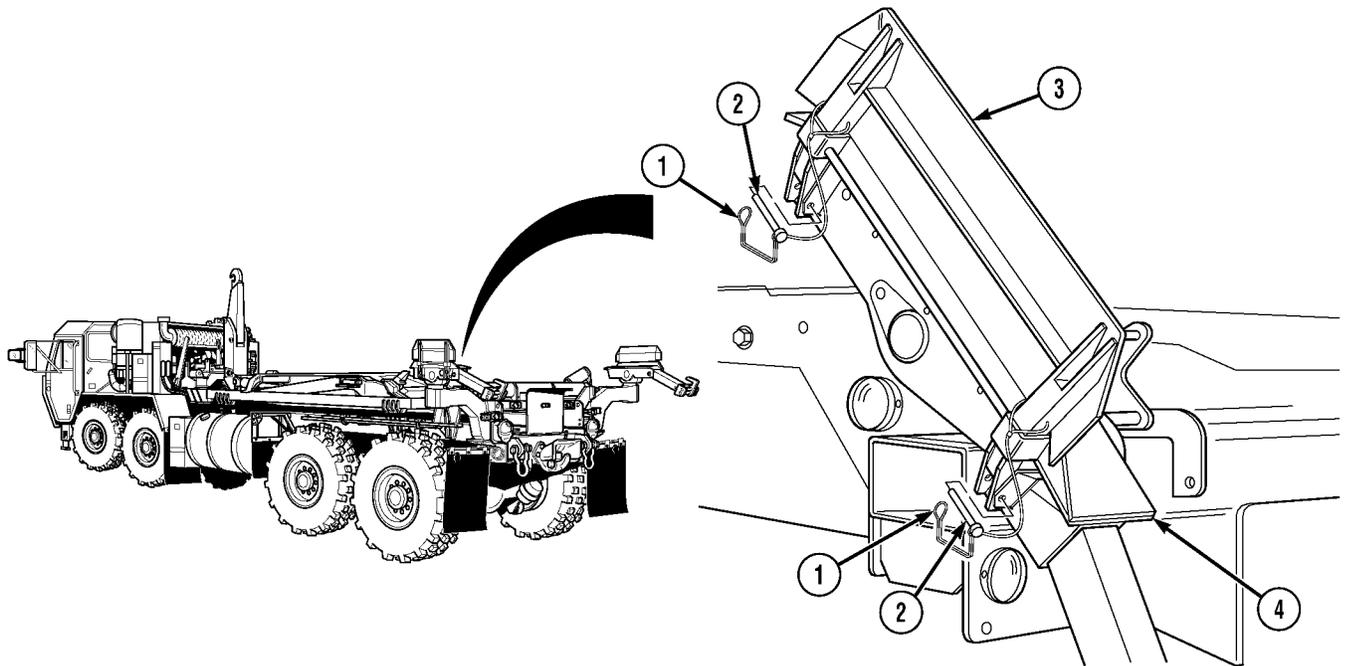

NOTE

There are two container guides on truck. Left side is shown.

- (1) Remove two lock pins (1), pins (2), and container guide (3) from slider (4).
- (2) Install two pins (2) and lock pins (1) in container guide (3).

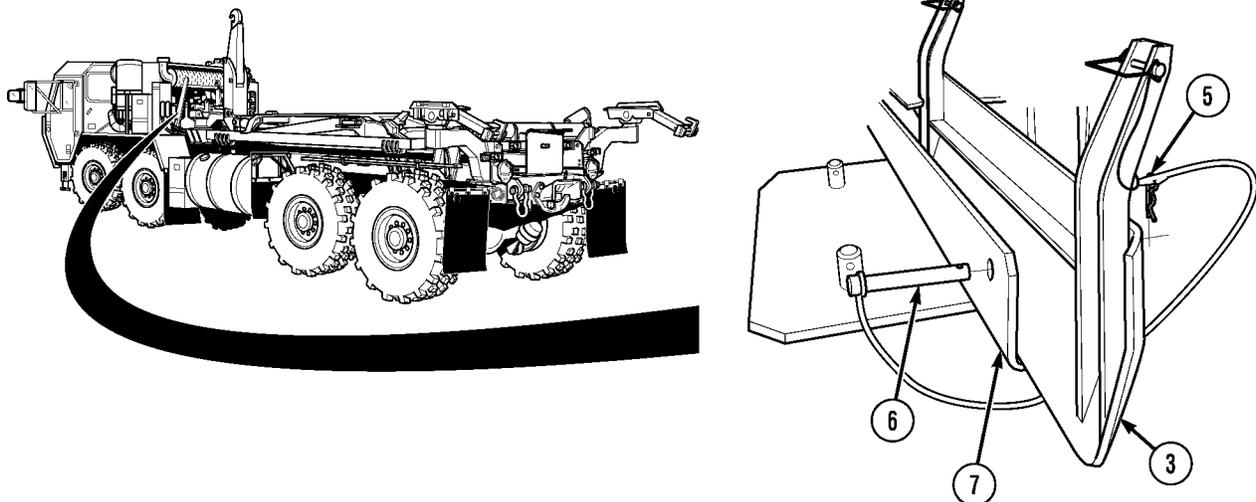

- (3) Remove lock pin (5) and pin (6) from stowage tray (7).
- (4) Position container guide (3) in stowage tray (7) with pin (6) and lock pin (5).

Operating Instructions (Cont)

2-10.1 CONTAINER HANDLING UNIT (CHU) (CONT).

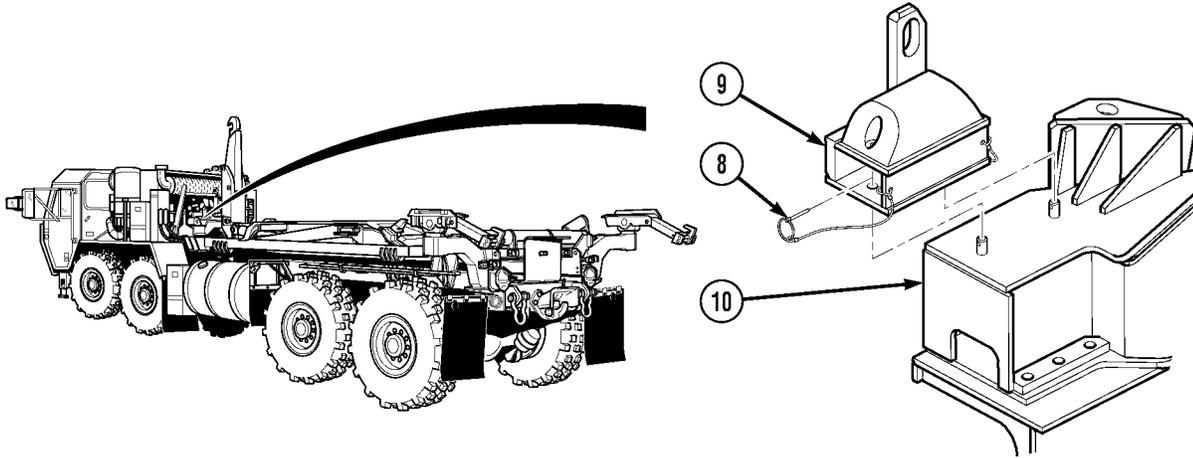

NOTE

There are two bumper supports on truck. Left side shown.

- (5) Remove lock pin (8) from bumper support (9).
- (6) Remove bumper support (9) from front container support (10).

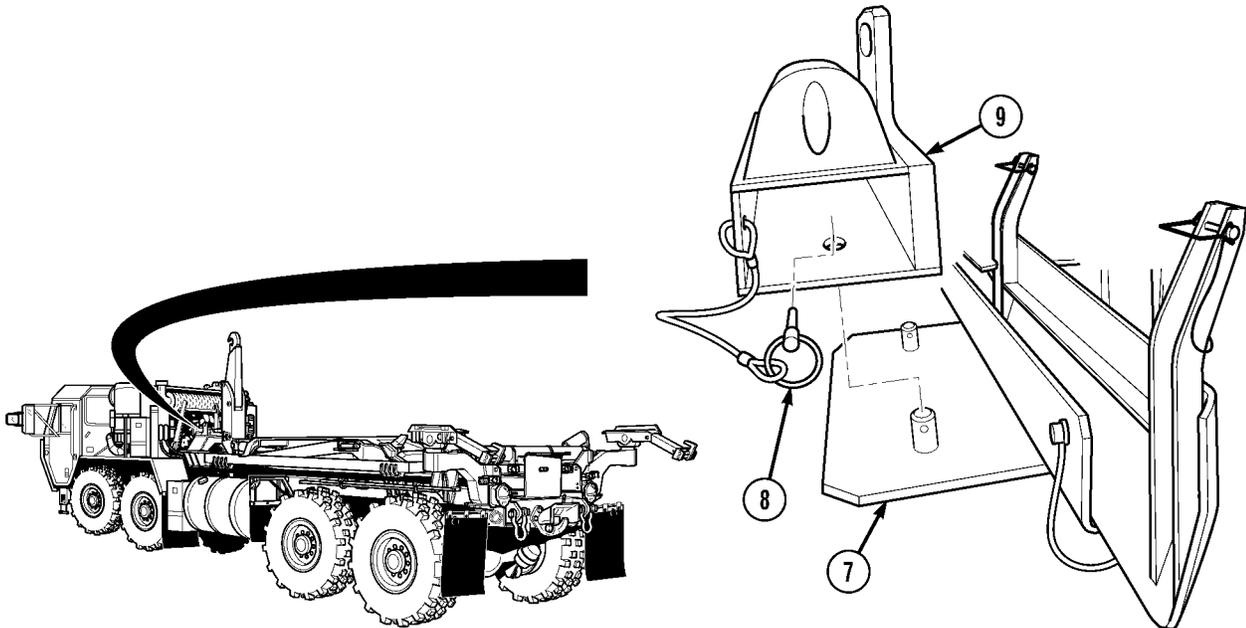

- (7) Stow bumper support (9) on stowage tray (7).
- (8) Install lock pin (8) in bumper support (9).
- (9) Repeat steps (1) through (8) for right side.

Operating Instructions (Cont)

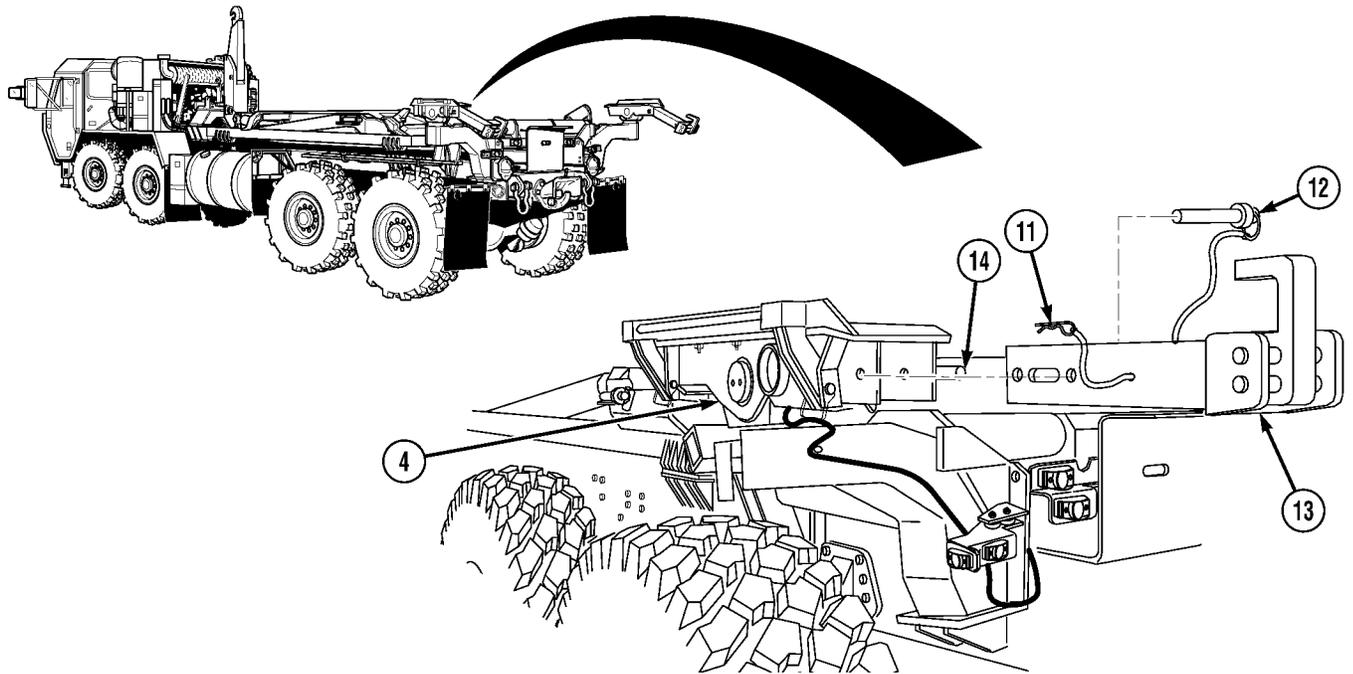
**NOTE**

There are two rear container locks on truck. Left side shown.

- (10) Remove lock pin (11) and pin (12) from slider (4) and rear container lock (13).
- (11) Support rear container lock (13) and turn handle (14) on slider (4) forward to unlocked position.
- (12) Remove rear container lock (13) from slider (4).

Operating Instructions (Cont)

2-10.1 CONTAINER HANDLING UNIT (CHU) (CONT).

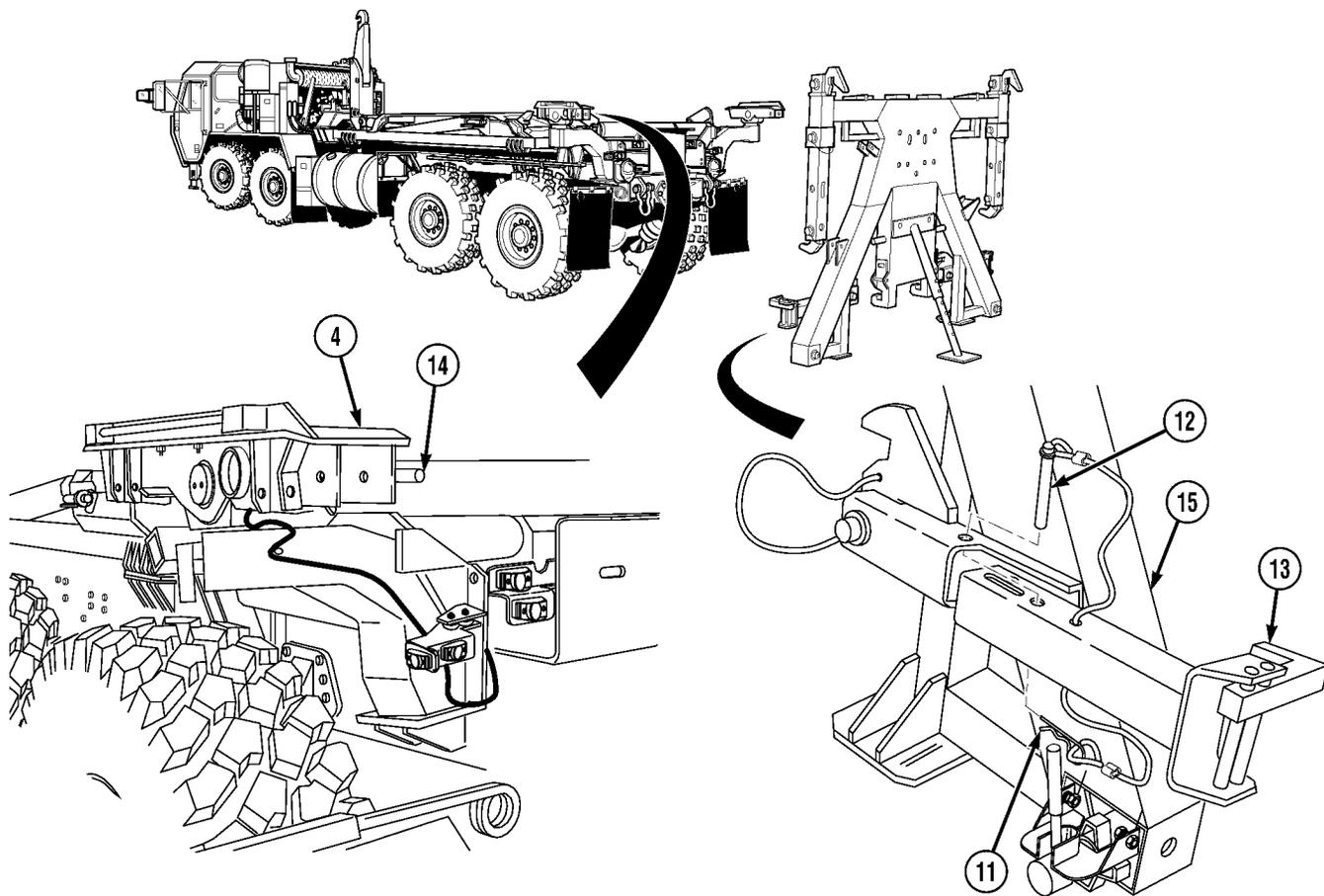

- (13) Install rear container lock (13), pin (12), and lock pin (11) in stowage bracket on front lift adapter (15).
- (14) Turn handle (14) on slider (4) back to locked position.
- (15) Repeat steps (10) through (14) for right side.

Operating Instructions (Cont)

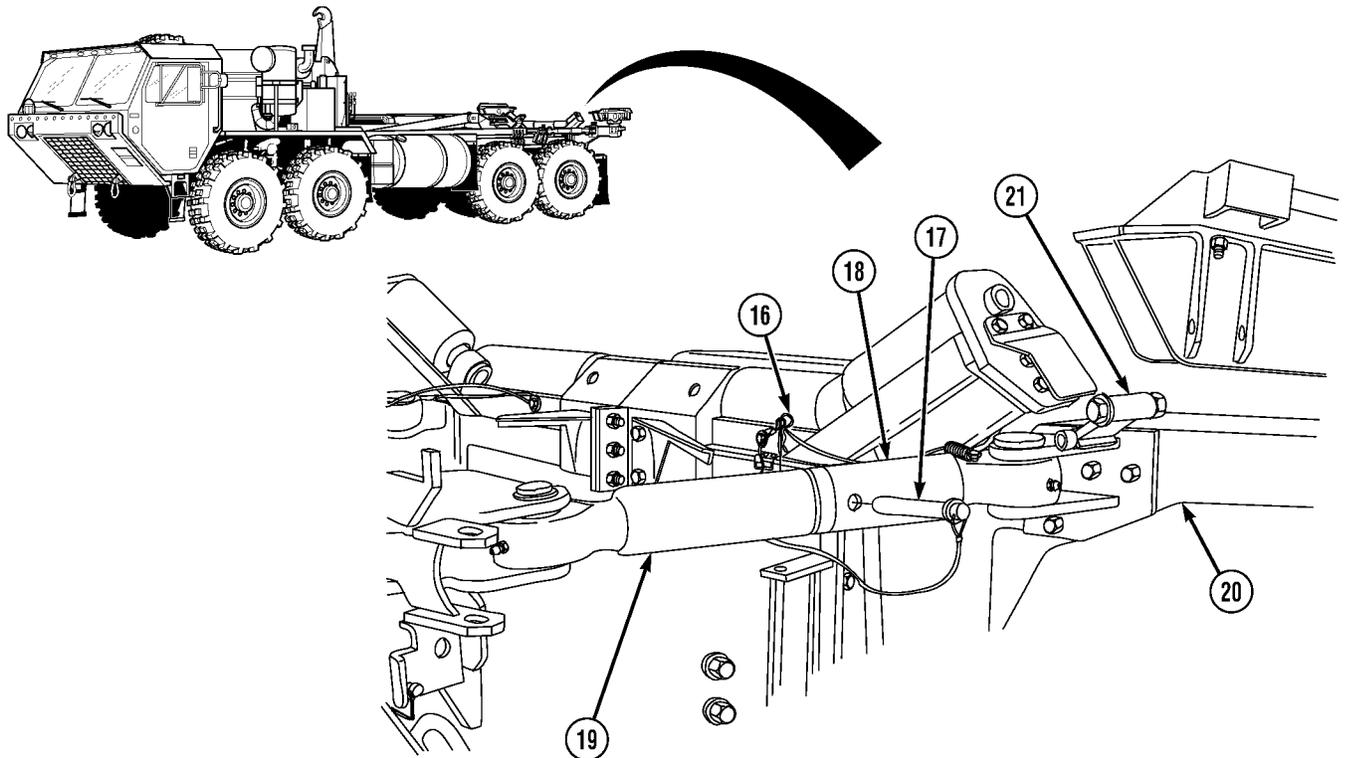

- (16) Remove lock pin (16) and pin (17) from short strut (18) and long strut (19).
- (17) Rotate slider arm (20) with handle outward to separate short strut (18) and long strut (19).
- (18) Position flip lock (21) up to hold slider arm (20) out.
- (19) Release slider arm (20).

Operating Instructions (Cont)

2-10.1 CONTAINER HANDLING UNIT (CHU) (CONT).

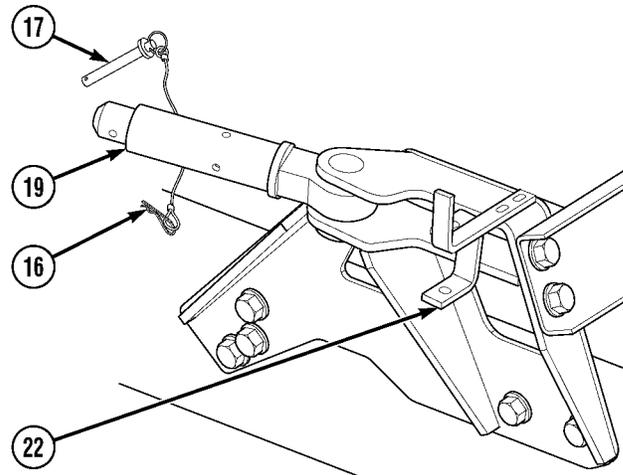

(20) Position long strut (19) on stowage bracket (22), install pin (17), and lock pin (16).

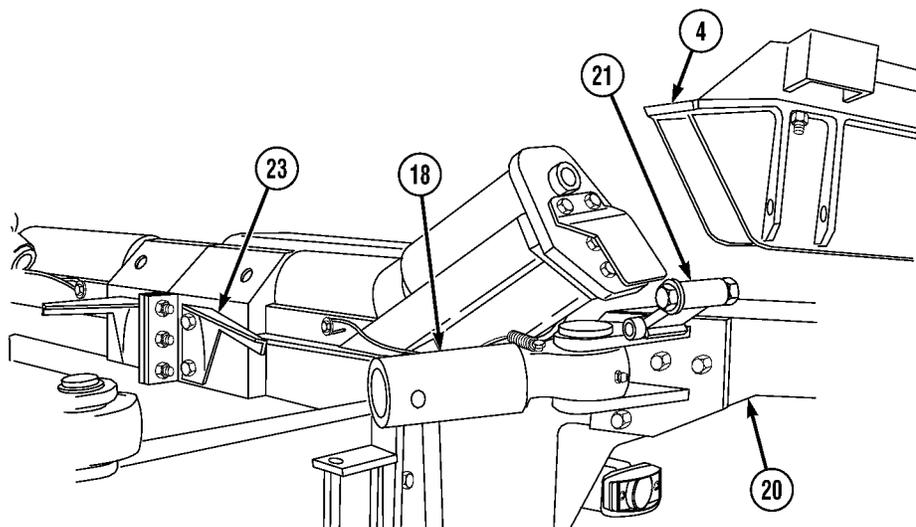

- (21) Rotate slider arm (20) with handle outward and disengage flip lock (21) by rotating it down.
- (22) Rotate slider arm (20) forward and front of slider (4) down and position short strut (18) on stow plates (23).

Operating Instructions (Cont)

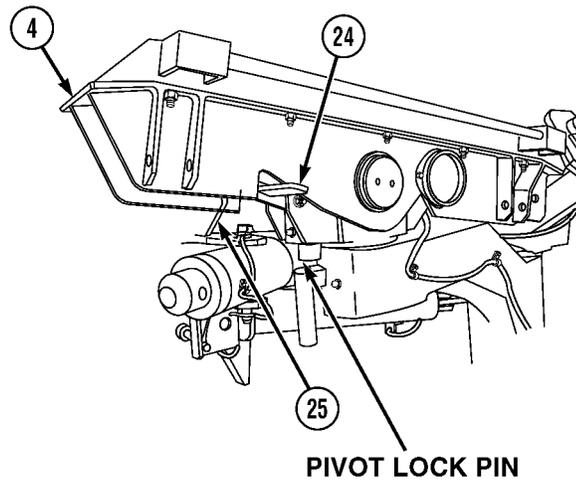

WARNING

Make sure not to hold on to front of slider when stowing. Hands and fingers may be pinched between front of slider and hard lift bracket causing injury to personnel.

NOTE

- Rear of slider may have to be pulled out slightly to position front of slider on retaining bracket.
 - Pivot lock pins may not lock if lock pin receptacle is full of debris. If this occurs, remove debris and lubricate lock pin and lock pin fitting.
- (23) Pull down pivot lock pin handle (24), lift rear of slider (4), and rotate front of slider over retaining plate (25) until pivot lock pins lock.
- (24) Release pivot lock pin handle (24).
- (25) Repeat steps (16) through (24) for right side.

Operating Instructions (Cont)

2-10.2 LOADING AND UNLOADING CONTAINER (82 INCHES [208 CM] OR TALLER) TO TRUCK USING FRONT LIFT ADAPTER (FLA).

a. Loading.

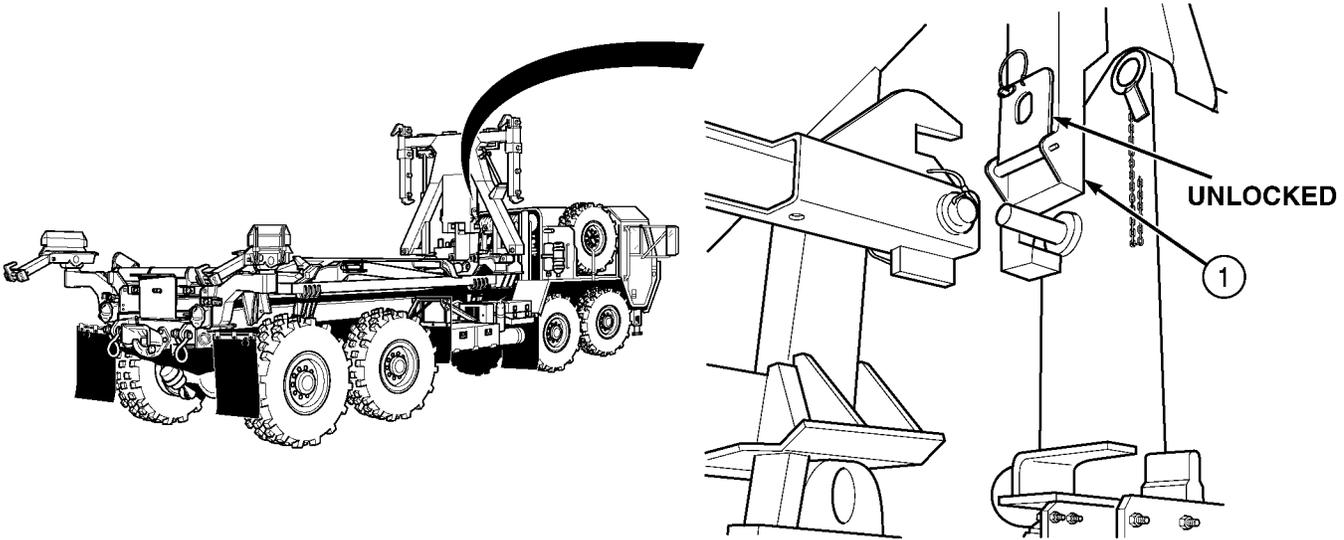

WARNING

Front lift adapter weighs 1,600 lbs. (726 kg). Personnel must stay clear when installing or removing front lift adapter to LHS hook arm hook. Failure to comply may result in injury or death to personnel.

CAUTION

Make sure front lift adapter is in the unlocked position before attempting to load a container to truck. Failure to comply will result in damage to equipment.

- (1) Make sure front lift adapter (1) is unlocked (Para 2-10.6).

Operating Instructions (Cont)

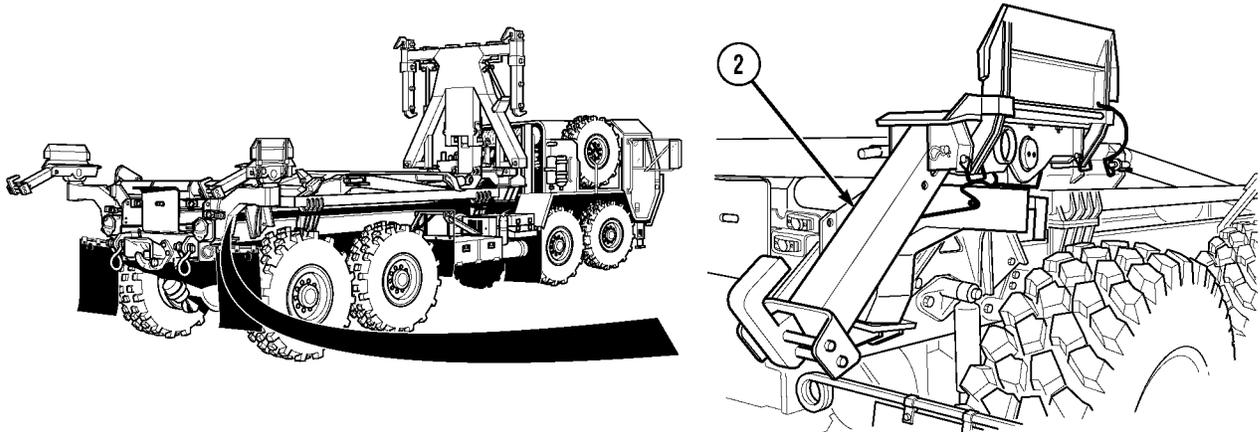

- (2) Make sure rear container lock (2) is in ready mode, refer to (Para 2-10.1).

WARNING

- Check for overhead power lines or other obstructions before attempting LHS operations. LHS reaches a height of 18-ft. (5.5 mm). Injury or death could result if LHS contacts power lines.
- Maximum permissible gross container weight is 24,000 lbs. (10 886 kg).
- Use caution when working around front lift adapter. Front lift adapter may swing unexpectedly when not attached to container. Failure to comply may result in injury or death to personnel.
- Do not stand between front lift adapter and container. Truck could roll, crushing personnel, causing serious injury or death.
- Do not attempt loading or unloading operations on a side slope greater than 5 degrees and/or fore/aft slope greater than 20 percent. Before attempting loading or unloading operations on slopes, determine if ground surface conditions permit safe loading or unloading operations. Slopes that contain snow, ice, loose gravel, or sand may not permit safe loading or unloading.

CAUTION

- Use extreme caution when loading/unloading container with side doors. Container must remain centered during loading/unloading, or flanges on side may be damaged and/or door hinges may make hard contact with guides.
- When operating CHU with nonstandard, end-opening, 20-ft.-long (6.1 mm) shipping containers, operator needs to take extra care to make sure that sliders and guides contact container properly, container slides on sliders properly, and container loads centered on truck. Failure to comply can result in container getting hung up or making hard contact with sliders and guides, causing damage to CHU or container.

Operating Instructions (Cont)

2-10.2 LOADING AND UNLOADING CONTAINER (82 INCHES [208 CM] OR TALLER) TO TRUCK USING FRONT LIFT ADAPTER (FLA) (CONT).

WARNING

Two personnel must be used (driver and spotter) to position front lift adapter (FLA). Failure to comply may result in damage to equipment and injury or death to personnel.

NOTE

- For detailed instructions on how to operate the LHS, refer to “LHS Controls and Indicators” (Para 2-1), “Picking-up a Flatrack in Auto Mode” (Para 2-9 b), and “Off-Loading Flatrack in Auto Mode” (Para 2-9 c).
- Rear mud flaps may be pinned up to provide better visibility of front lift adapter lower container locks.
- Multiple connected containers cannot be used with CHU. This includes Six CONS and Quad CONS.

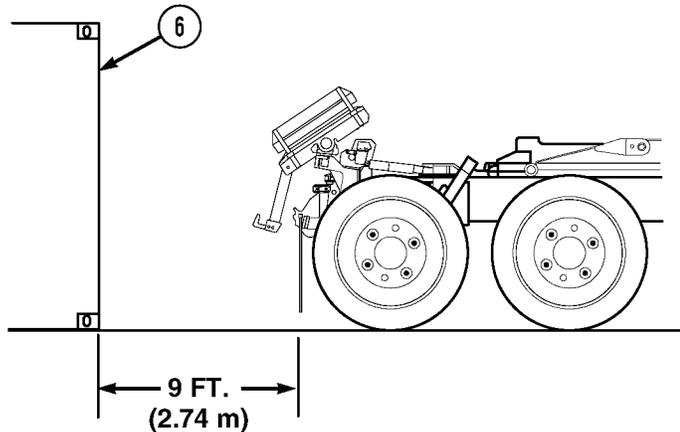
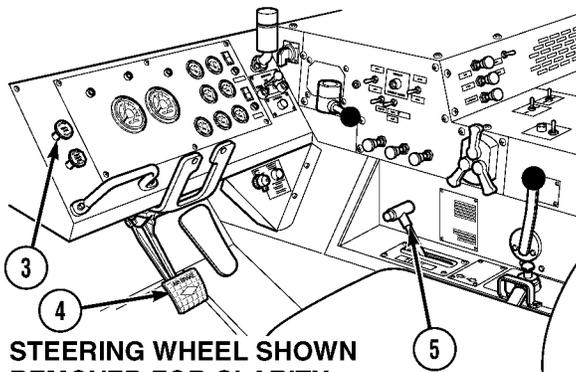

- (3) Start engine (TM 9-2320-279-10).
- (4) Push in parking brake knob (3), apply service brake pedal (4), and set transmission range selector (5) to R (Reverse).
- (5) Release service brake pedal (4) and position rear of truck within 9 ft. (2.74 m) of front of container (6), aligning centerline of truck within 2 in. (50 cm) of container centerline.

Operating Instructions (Cont)

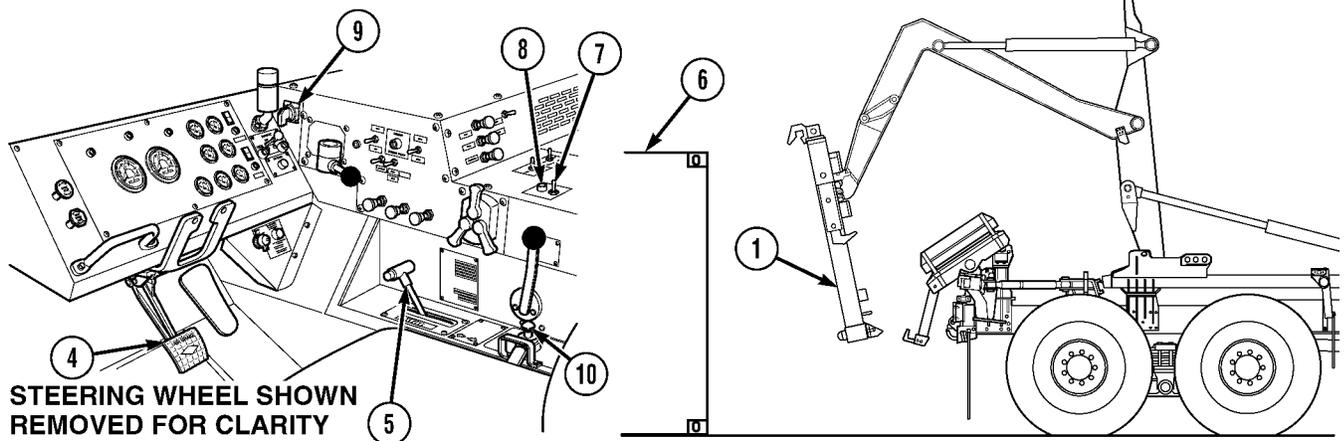

- (6) Apply service brake pedal (4) and set transmission range selector (5) to N (Neutral).
- (7) Put PTO ENGAGE switch (7) in ON position. Make sure indicator light (8) comes on.

CAUTION

Engine speed must be at idle before using hydraulic selector switch, or damage to equipment may result.

- (8) Turn hydraulic selector switch (9) to AUTO.

CAUTION

On steep downgrades, contact is possible between the front lift adapter lower legs and the rear sliders during empty LHS cycles. If contact appears likely, switch hydraulic selector to MAN H.A. position and retract (LOAD) hook arm a few inches. Return hydraulic selector to AUTO and continue (UNLOAD) operation. Repeat as required. Failure to comply may result in damage to equipment.

- (9) Move joystick (10) to UNLOAD position until front lift adapter (1) is positioned in front of container (6).

Operating Instructions (Cont)

2-10.2 LOADING AND UNLOADING CONTAINER (82 INCHES [208 CM] OR TALLER) TO TRUCK USING FRONT LIFT ADAPTER (FLA) (CONT).

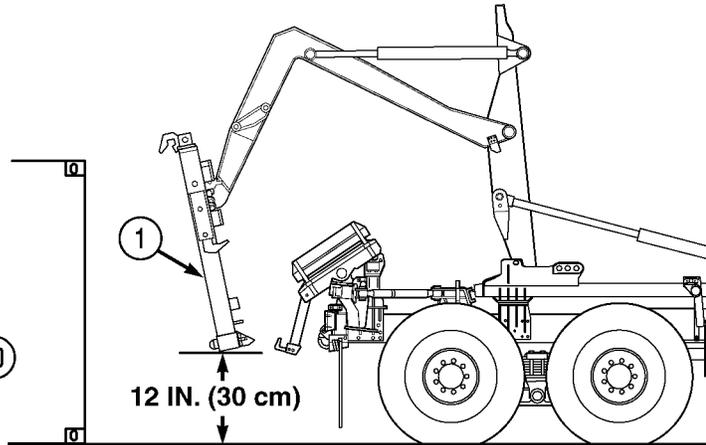
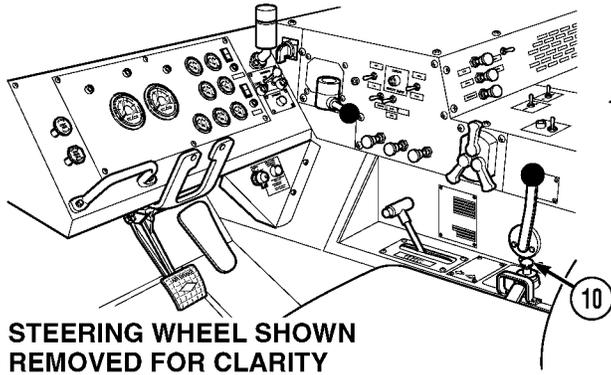

- (10) Operate LHS in AUTO mode until front lift adapter (1) is approximately 12 in. (30 cm) off of ground.
- (11) Release joystick (10).
- (12) Shut off engine (TM 9-2320-279-10).

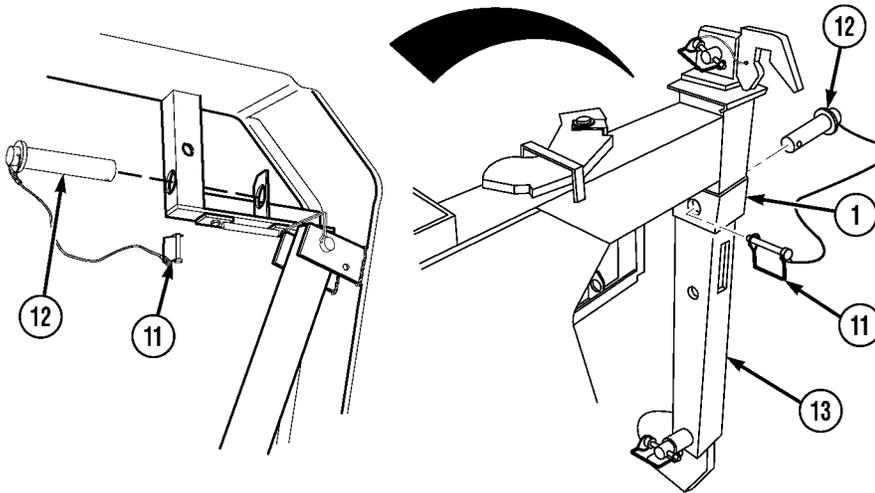

NOTE

- Refer to the front lift adapter data plate for the proper configuration needed for the height of each container being loaded.
- There are two slide arms. Right side shown.

- (13) Remove lock pin (11) and pin (12) from front lift adapter (1) and slide arm (13) upper hole.
- (14) Install pin (12) and lock pin (11) in stow position on front lift adapter (1).
- (15) Repeat steps (13) and (14) for left side.

Operating Instructions (Cont)

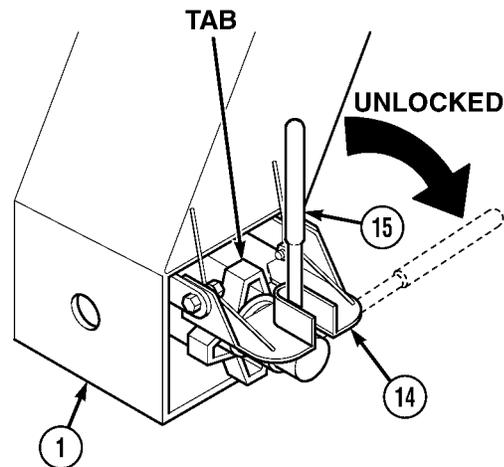
**NOTE**

- There are two front lift adapter lower container locks and rear sliders. Right side shown.
- Make sure front lift adapter lower container lock handle is positioned in slot on handle lock plate.
- Make sure tab on handnut faces up.

- (16) Raise handle lock plate (14) and rotate lower container lock handle (15) toward center of front lift adapter (1) to unlocked position.
- (17) Release handle lock plate (14) on front lift adapter (1).
- (18) Repeat steps (16) and (17) for left side.

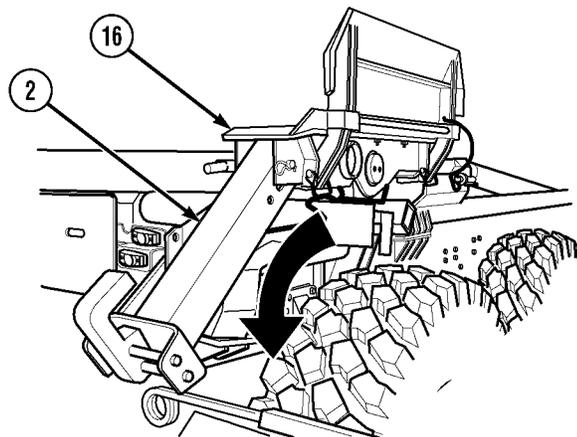
**CAUTION**

Make sure sliders are clear of debris and surfaces are properly greased or damage to equipment may result.

NOTE

There are two rear sliders and container locks. Right side shown.

- (19) Rotate slider (16) so rear of slider faces down.
- (20) Make sure rear container lock (2) is in ready mode or down position (Para 2-10.1).
- (21) Repeat steps (19) and (20) for left side.
- (22) Start engine (TM 9-2320-279-10).

Operating Instructions (Cont)

2-10.2 LOADING AND UNLOADING CONTAINER (82 INCHES [208 CM] OR TALLER) TO TRUCK USING FRONT LIFT ADAPTER (FLA) (CONT).

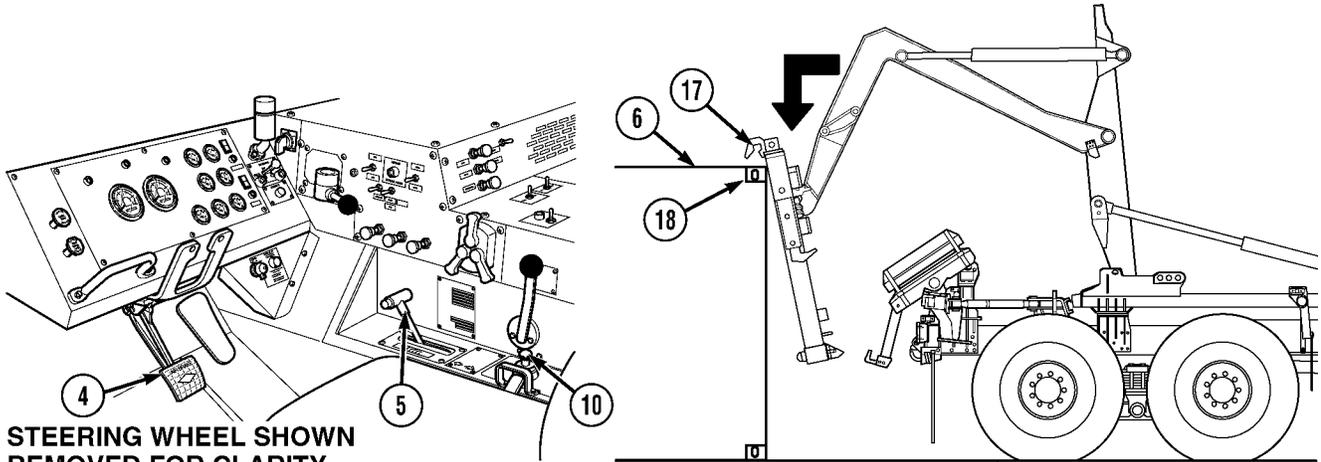

- (23) Position slide arm upper front hooks (17) just below and in front of container upper corner castings (18).
- (24) Apply service brake pedal (4) and set transmission range selector (5) to R (Reverse).

WARNING

Do not allow front lift adapter to contact the ground when slide arm upper front hooks are not engaged with container upper corner castings. Failure to comply may result in damage to equipment and injury or death to personnel.

- (25) Release service brake pedal (4) and slowly back up to approximately 12 in. (30 cm) from front of container (6).

NOTE

LHS will only operate when transmission range selector is in N (Neutral).

- (26) Apply service brake pedal (4), set transmission range selector (5) to N (Neutral), move joystick (10) to LOAD, and raise front lift adapter until front hooks (17) are above container upper corner castings (18).
- (27) Set transmission range selector (5) to R (Reverse). Release service brake pedal (4) and slowly back up until slide arm upper front hooks (17) are just above front of container upper corner castings (18).

Operating Instructions (Cont)

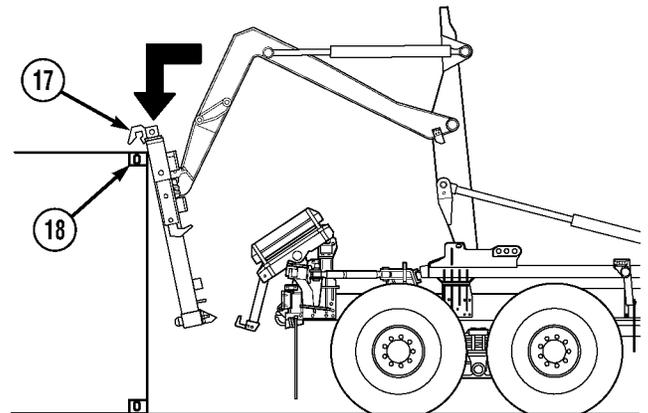
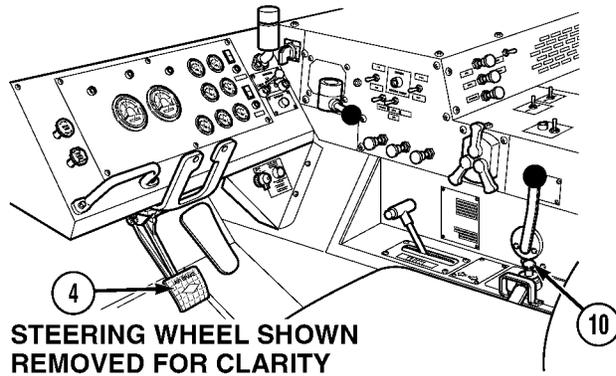
**CAUTION**

Make sure slide arm upper front hooks are fully engaged with container upper corner castings. Failure to comply may result in damage to equipment.

NOTE

- To get upper hooks to properly seat, it may be necessary to drive truck forward slightly.
 - When container is on side slope, it may be difficult to get both upper hooks properly seated. Front lift adapter hangs level. To get front lift adapter to hang closer to same angle as container, it may be necessary to temporarily remove one rear container lock from slider and stow on downhill side of front lift adapter.
 - LHS will only operate when transmission range selector is in N (Neutral).
- (28) Release service brake pedal (4) and, moving joystick (10) to UNLOAD, lower slide arm upper front hooks (17) into container upper corner castings (18).

Operating Instructions (Cont)

2-10.2 LOADING AND UNLOADING CONTAINER (82 INCHES [208 CM] OR TALLER) TO TRUCK USING FRONT LIFT ADAPTER (FLA) (CONT).

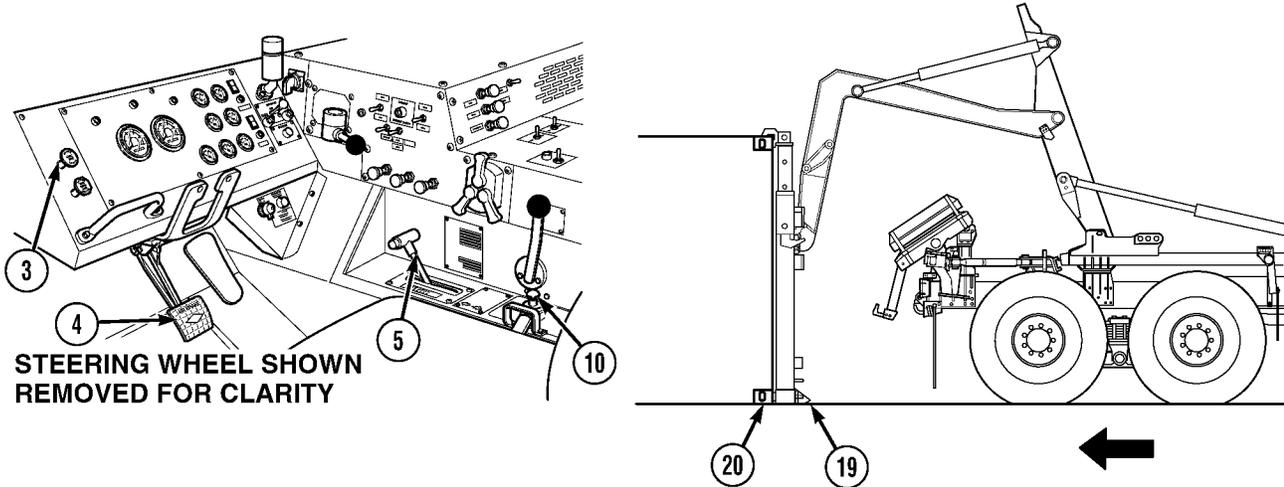

NOTE

LHS will only operate when transmission range selector is in N (Neutral).

- (29) Apply service brake pedal (4) and set transmission range selector (5) to D (Drive).
- (30) Release service brake pedal (4) and move truck forward approximately 12 in. (30 cm).
- (31) Apply service brake pedal (4) and set transmission range selector (5) to N (Neutral).
- (32) Move joystick (10) to UNLOAD until lower container locks (19) are aligned with container lower front corner castings (20).
- (33) Apply service brake pedal (4) and set transmission range selector (5) to R (Reverse). Back truck up until lower container locks (19) are seated in container lower front corner castings (20).
- (34) Apply service brake pedal (4) and set transmission range selector (5) to N (Neutral). Pull out parking brake knob (3) to apply parking brakes.

Operating Instructions (Cont)

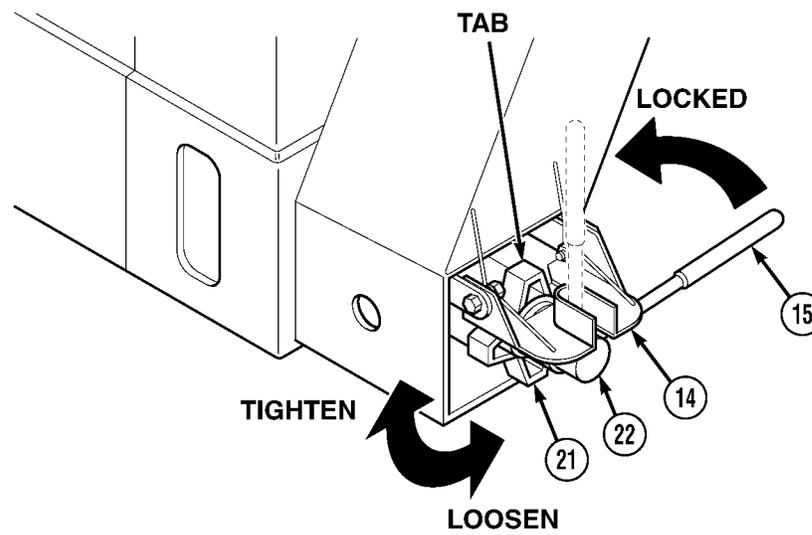
**CAUTION**

Make sure lower container locks are fully engaged with container lower front corner castings. Failure to comply may result in damage to equipment.

NOTE

- To get container lock handle to rotate, it may be necessary to loosen handnut.
- There are two lower container locks. Right side shown.
- After tightening handnut, it may be necessary to loosen handnut slightly to align tab with handle lock plate.
- Make sure lower container lock handle is secured in slot on handle lock plate.

(35) Hold handle lock plate (14) up and rotate lower container lock handle (15) up in the locked position.

(36) Turn handnut (21) clockwise and tighten stem (22).

Operating Instructions (Cont)

2-10.2 LOADING AND UNLOADING CONTAINER (82 INCHES [208 CM] OR TALLER) TO TRUCK USING FRONT LIFT ADAPTER (FLA) (CONT).

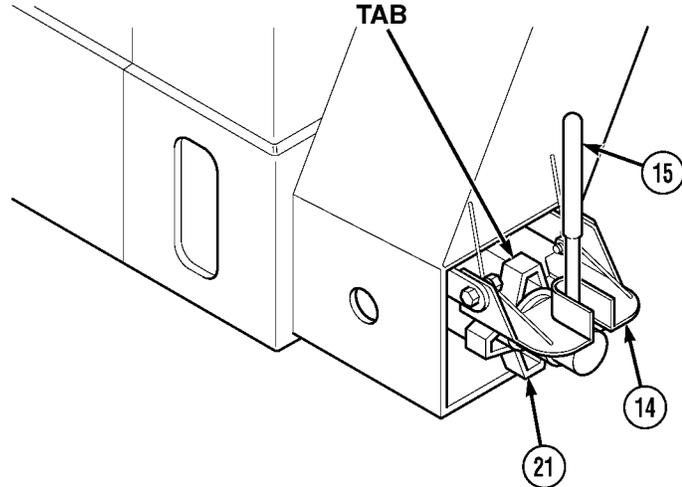
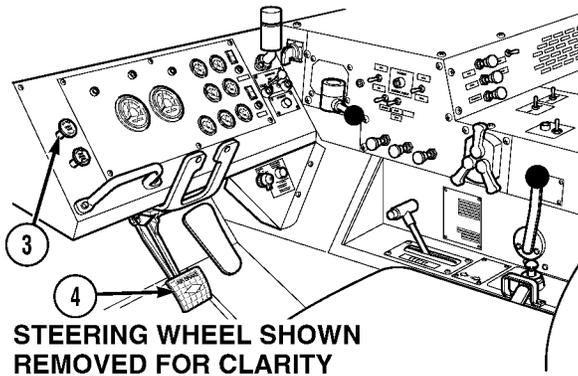

NOTE

Make sure tab on handnut faces up.

- (37) Lower handle lock plate (14) over lower container lock handle (15) and handnut (21) tab.
- (38) Repeat steps (35) through (37) for left side.
- (39) Push in parking brake knob (3) to release parking brakes and release service brake pedal (4).

WARNING

When loading or unloading containers on uneven ground (side slope up to 5 degrees and downgrades up to 20 percent), it may be necessary to apply truck service brakes to prevent truck rollaway or severe injury or death could result.

CAUTION

- If LHS OVER LOAD indicator illuminates but loading operation continues, operator is cautioned that LHS is nearing maximum capacity. In this situation, operator should notify supervisor if it appears payload is unevenly distributed in container or if container load exceeds 24,000 lbs. (10 886 kg). If any of these conditions exist, payload must be redistributed or reduced, or damage to equipment may result.
- Load must be evenly distributed in the container. Uneven load distribution may cause the LHS OVER LOAD indicator to give false signals and cause the LHS to operate incorrectly. Damage to equipment may result.
- If LHS OVER LOAD indicator illuminates and normal operation has stopped, return load to original position and notify supervisor to have payload redistributed or weight reduced. Failure to comply may result in damage to equipment.
- Make sure parking brake is not applied before starting load sequence, or damage to equipment may occur.

Operating Instructions (Cont)**NOTE**

- The amount of time to load and unload is controlled by engine speed. Engine speed can be increased to approximately 1500 rpm to reduce loading and unloading times.
- LHS will only operate when transmission range selector is in N (Neutral).
- If container is extremely light or empty, it may be necessary to place transmission range selector to R (Reverse) and allow truck to roll under container.
- If container is not centered, and transit locks cannot be installed and pinned, repeat steps (39) through (48) to reposition container.

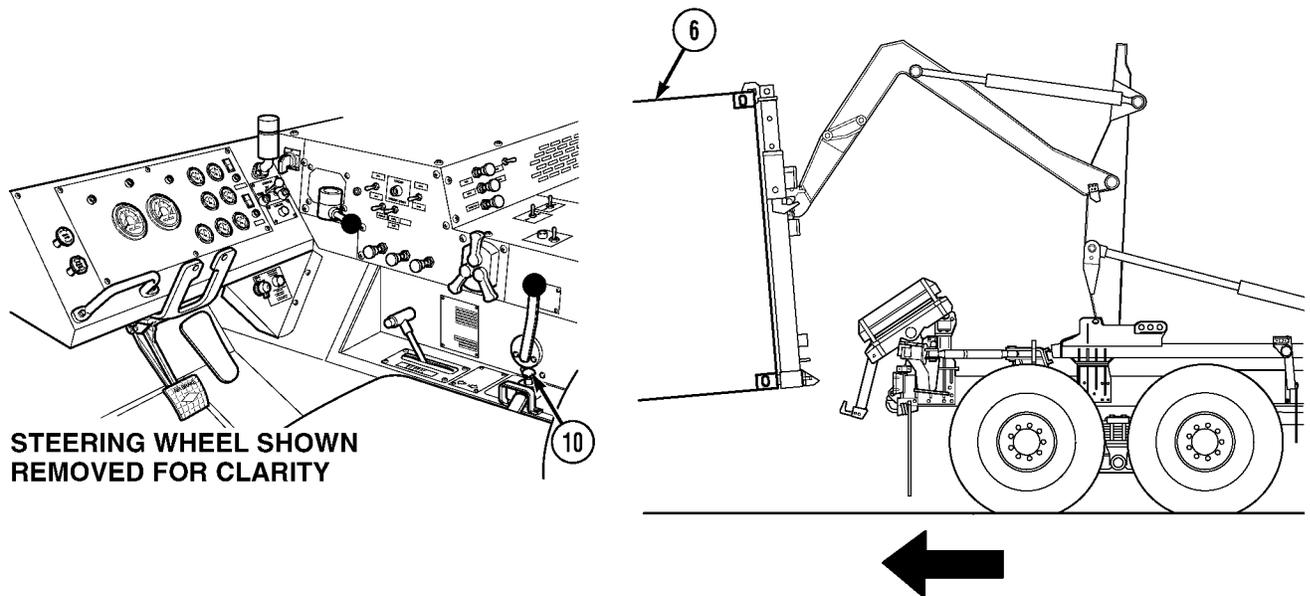

(40) Move joystick (10) to LOAD, allowing truck to be pulled under container (6).

Operating Instructions (Cont)

2-10.2 LOADING AND UNLOADING CONTAINER (82 INCHES [208 CM] OR TALLER) TO TRUCK USING FRONT LIFT ADAPTER (FLA) (CONT).

WARNING

Make sure that container has contacted rear sliders correctly and is between guides. Failure to comply may result in serious injury or death to personnel and damage to equipment.

CAUTION

Reduce engine speed to idle before container contacts rear sliders, or damage to equipment may result.

NOTE

- LHS OVER LOAD indicator may illuminate when lifting container from unusual conditions.
- As load is lifted, truck will be pulled under container. Some steering wheel adjustment may have to be made to make sure that container contacts rear sliders correctly and is between guides.

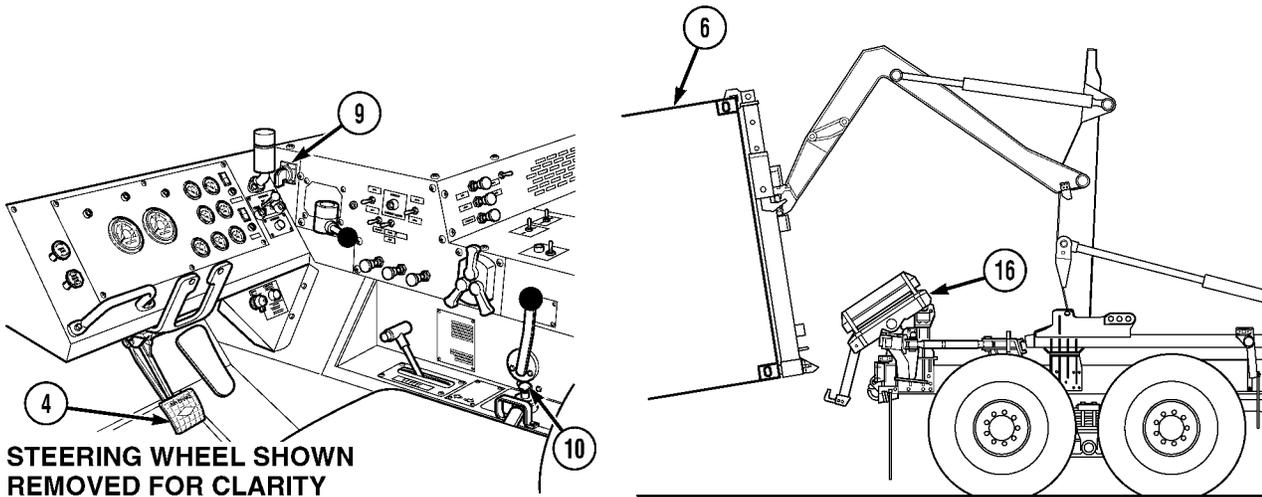

(41) As container (6) contacts rear sliders (16), reduce engine speed to idle and apply service brake pedal (4).

CAUTION

Engine speed must be at idle before using hydraulic selector switch, or damage to equipment may result.

NOTE

If container is being loaded in soft soil conditions, perform steps (42) through (44).

(42) Release joystick (10). Set hydraulic selector switch (9) to MAN H.A. position.

Operating Instructions (Cont)

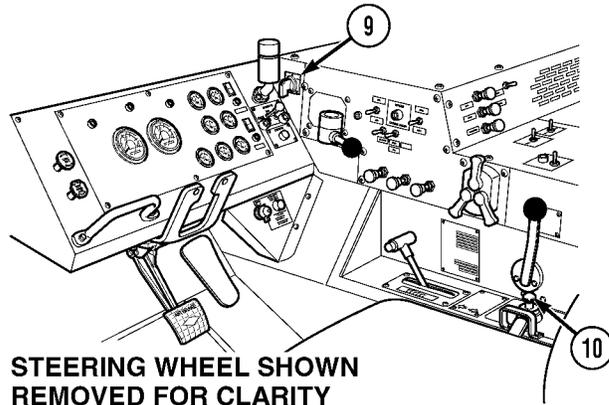

STEERING WHEEL SHOWN REMOVED FOR CLARITY

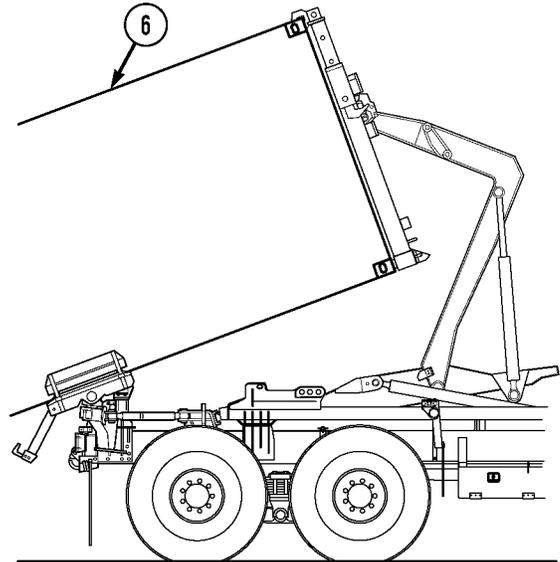

- (43) Move joystick (10) to LOAD until container (6) is approximately 2 ft. (61 cm) off the ground. Release joystick.

CAUTION

Engine speed must be at idle before using hydraulic selector switch, or damage to equipment may result.

- (44) Set hydraulic selector switch (9) to AUTO. Resume normal AUTO operations.

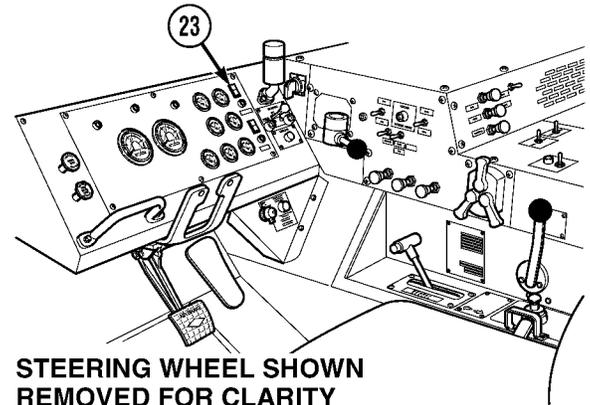
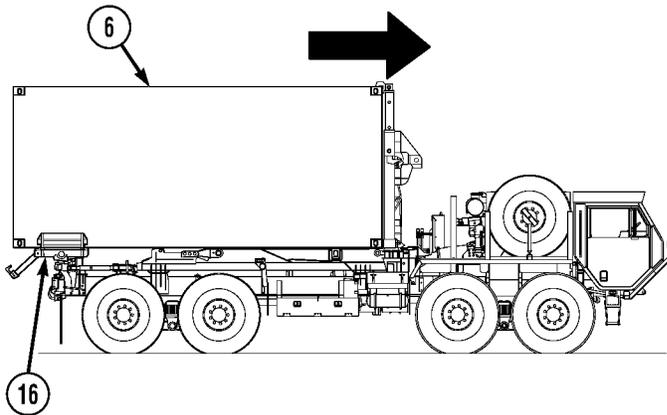

STEERING WHEEL SHOWN REMOVED FOR CLARITY

NOTE

Engine speed may be increased and decreased to ease loading.

- (45) After container (6) contacts rear sliders (16), increase engine speed to approximately 1500 rpm until container is almost loaded. Reduce engine speed to idle.
- (46) Continue loading until container (6) is fully loaded and LHS NO TRANS lamp (23) goes out.

Operating Instructions (Cont)

2-10.2 LOADING AND UNLOADING CONTAINER (82 INCHES [208 CM] OR TALLER) TO TRUCK USING FRONT LIFT ADAPTER (FLA) (CONT).

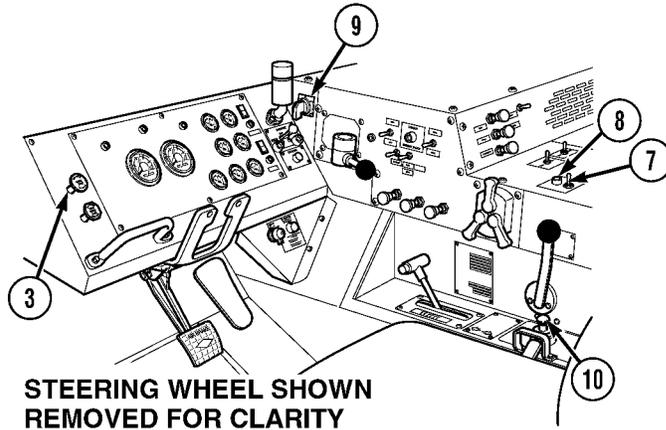

- (47) Release joystick (10).
- (48) Pull out parking brake knob (3) to apply parking brake.

CAUTION

- Engine speed must be at idle before using hydraulic selector switch, or damage to equipment may result.
- Hydraulic selector switch must be in the OFF position before driving truck, or hydraulic system could overheat.

- (49) Turn hydraulic selector switch (9) to OFF.
- (50) Put PTO ENGAGE switch (7) in OFF position. Make sure indicator light (8) goes off.
- (51) Shut off engine (TM 9-2320-279-10).

Operating Instructions (Cont)

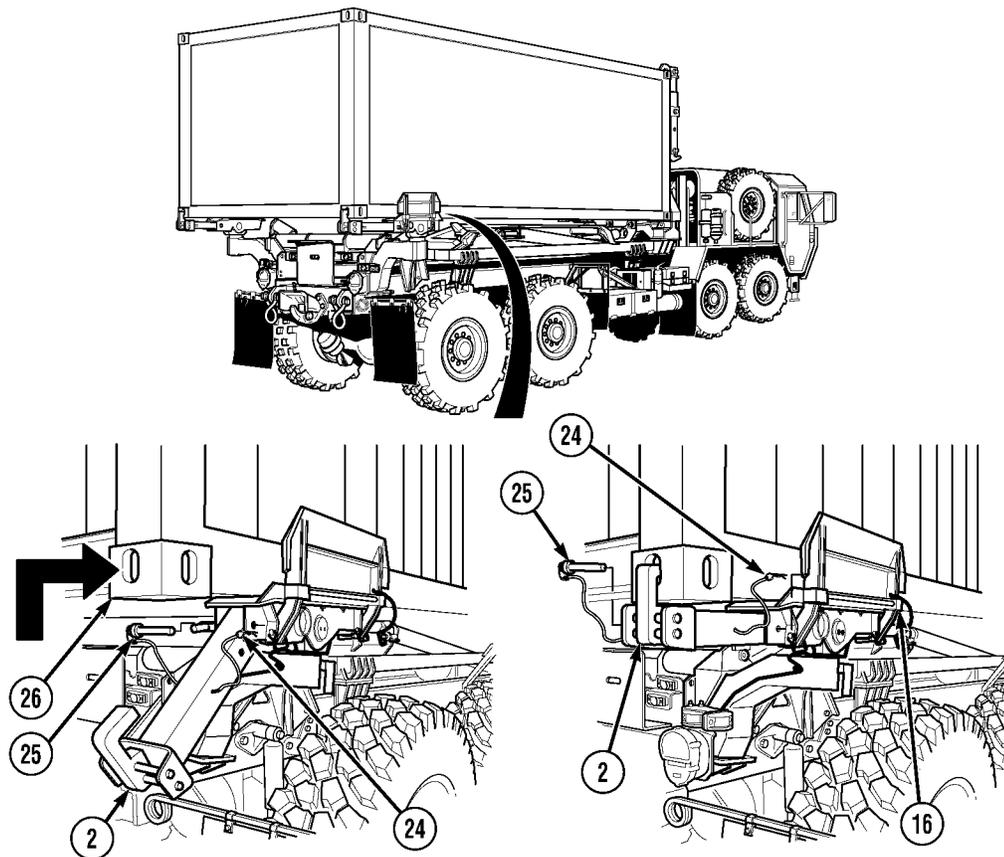
**NOTE**

- There are two rear container locks. Right side shown.
- If container is not centered and transit locks cannot be installed and pinned, repeat steps (39) through (48) to reposition container.

- (52) Support rear container lock (2) and remove lock pin (24) and pin (25).
 (53) Rotate rear container lock (2) up and position into container lower rear corner casting (26).
 (54) Install pin (25) and lock pin (24) in rear container lock (2) and slider (16).
 (55) Perform steps (52) through (54) for left side.

WARNING

- When loaded with a container, the center of gravity is moved up and toward rear of truck. Extreme caution must be taken when turning and ascending or descending on a grade. Failure to use extreme caution could result in severe injury or death to personnel.
- Maximum side slope when loaded with a container is 30 percent. Failure to comply may result in equipment damage or severe injury or death to personnel.
- Do not reduce tire pressure when loaded with FRS or container. Highway tire pressure, 60 psi (414 kPa) front and 83 psi (572 kPa) rear, is required at all times when loaded with FRS or container. Failure to comply could result in damage to equipment and severe injury or death to personnel.

Operating Instructions (Cont)

2-10.2 LOADING AND UNLOADING CONTAINER (82 INCHES [208 CM] OR TALLER) TO TRUCK USING FRONT LIFT ADAPTER (FLA) (CONT).

b. Unloading.

WARNING

- Check for overhead power lines or other obstructions before attempting LHS operations. LHS reaches a height of 18 ft. (5.5 m). Injury or death could result if LHS contacts power lines.
- Do not attempt loading or unloading operations on a side slope greater than 5 degrees and/or fore/aft slope greater than 20 percent. Before attempting loading or unloading operations on slopes, determine if ground surface conditions permit safe loading or unloading operations. Slopes that contain snow, ice, loose gravel, or sand may not permit safe loading or unloading.
- Check ground conditions for firmness and extreme sideways inclination before picking up or off-loading a container. Any ground instability beneath road wheels could cause serious injury or death to personnel.
- Prior to and during any load or unload cycle, all personnel should stay clear of LHS, front lift adapter, and container, or serious injury or death may result.

CAUTION

- Check that ground conditions where container will be placed can support the container weight or damage to the container, front lift adapter, or LHS may result.
- Use extreme caution when loading/unloading container with side doors. Container must remain centered during loading/ unloading or flanges on side may be damaged and/or door hinges may make hard contact with guides.

NOTE

For detailed instructions on how to operate the LHS, refer to “LHS Controls and Indicators” (Para 2-1), “Picking Up a Flatrack in Auto Mode” (Para 2-9 b), and “Off-Loading Flatrack in Auto Mode” (Para 2-9 c).

- (1) Check area for operating room at front and rear of truck. Check overhead clearance and ground conditions.

Operating Instructions (Cont)

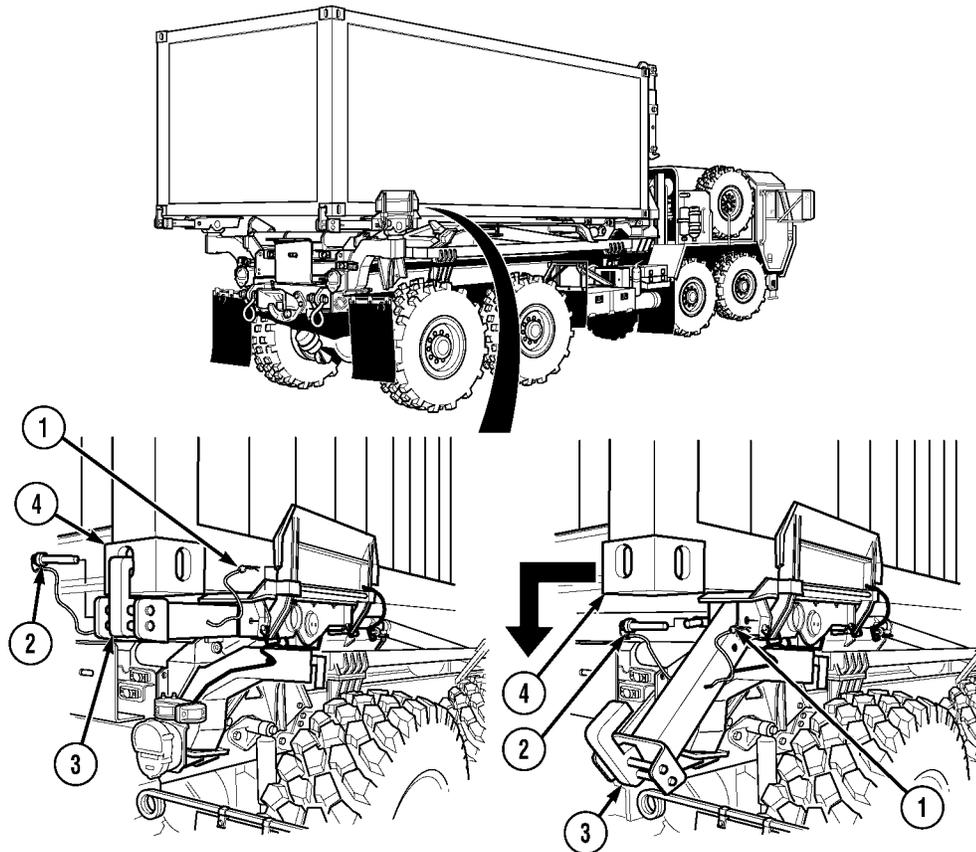

NOTE

There are two rear container locks. Right side shown.

- (2) Remove lock pin (1), pin (2), and rear container lock (3) from lower rear corner casting (4).
- (3) Rotate rear container lock (3) in down position and install pin (2) and lock pin (1).
- (4) Perform steps (2) and (3) for left side.

Operating Instructions (Cont)

2-10.2 LOADING AND UNLOADING CONTAINER (82 INCHES [208 CM] OR TALLER) TO TRUCK USING FRONT LIFT ADAPTER (FLA) (CONT).

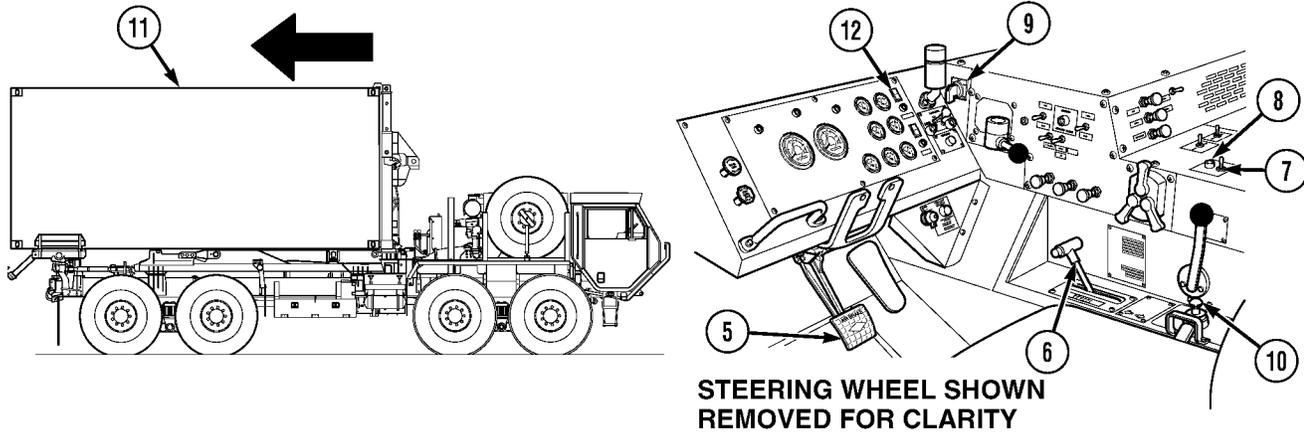

- (5) Start engine (TM 9-2320-279-10).
- (6) Apply service brake pedal (5) and set transmission range selector (6) to N (Neutral).
- (7) Put PTO ENGAGE switch (7) in ON position. Make sure indicator light (8) comes on.

CAUTION

Engine speed must be at idle before using hydraulic selector switch, or damage to equipment may result.

- (8) Turn hydraulic selector switch (9) to AUTO.

WARNING

When loading or unloading containers on uneven ground (side slope up to 5 degrees and downgrades up to 20 percent), it may be necessary to apply truck service brakes to prevent truck rollaway or severe injury or death could result.

NOTE

LHS will not operate and unload if rear container locks are engaged.

- (9) Move joystick (10) to UNLOAD. Container (11) will start to move rearward. LHS NO TRANS lamp (12) will illuminate. Maintain engine speed at idle until front of container raises approximately 12 in. (30 cm).

Operating Instructions (Cont)

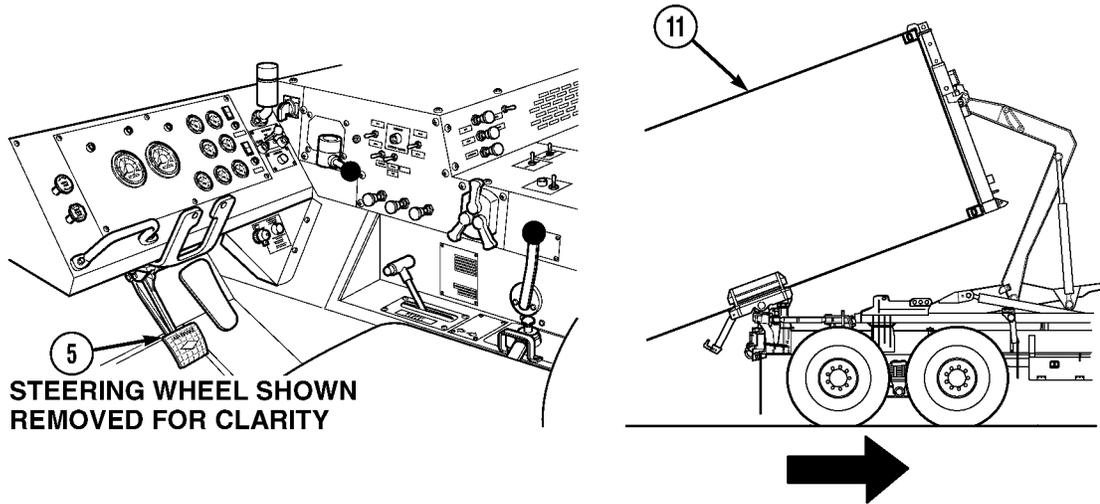

STEERING WHEEL SHOWN REMOVED FOR CLARITY

NOTE

The amount of time to load and unload is controlled by engine speed. Engine speed can be increased to approximately 1500 rpm to reduce loading and unloading times.

- (10) Continue to unload container (11) until back edge of container touches ground.
- (11) Release service brake pedal (5) and allow container (11) to push truck forward from under container.

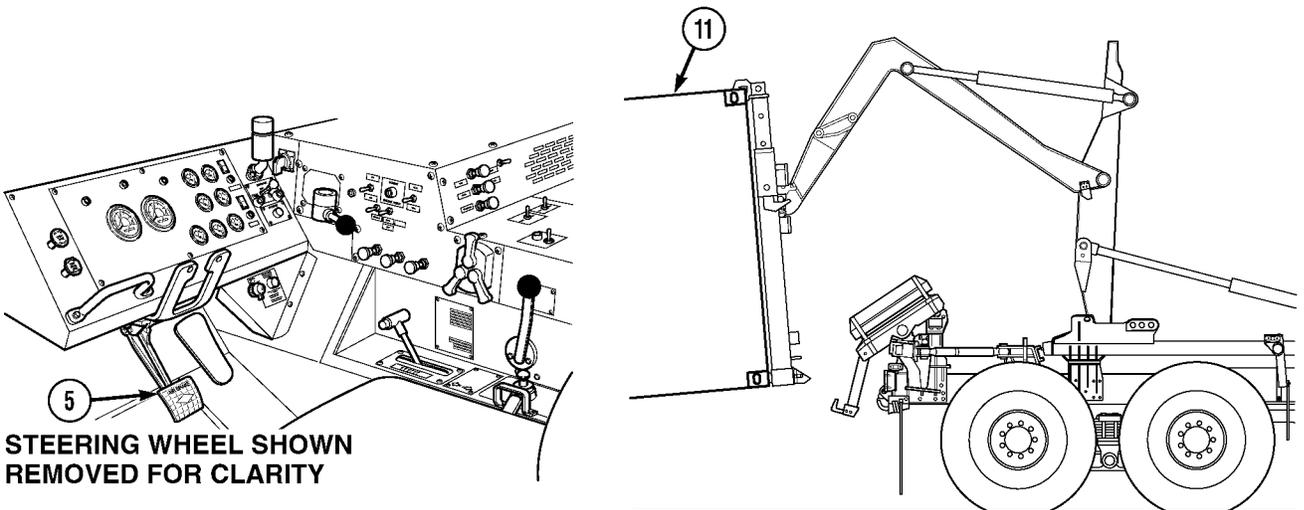

STEERING WHEEL SHOWN REMOVED FOR CLARITY

- (12) As front of container (11) approaches within approximately 8 in. (20.3 cm) of ground, decrease engine speed to idle and apply service brake pedal (5).

Operating Instructions (Cont)

2-10.2 LOADING AND UNLOADING CONTAINER (82 INCHES [208 CM] OR TALLER) TO TRUCK USING FRONT LIFT ADAPTER (FLA) (CONT).

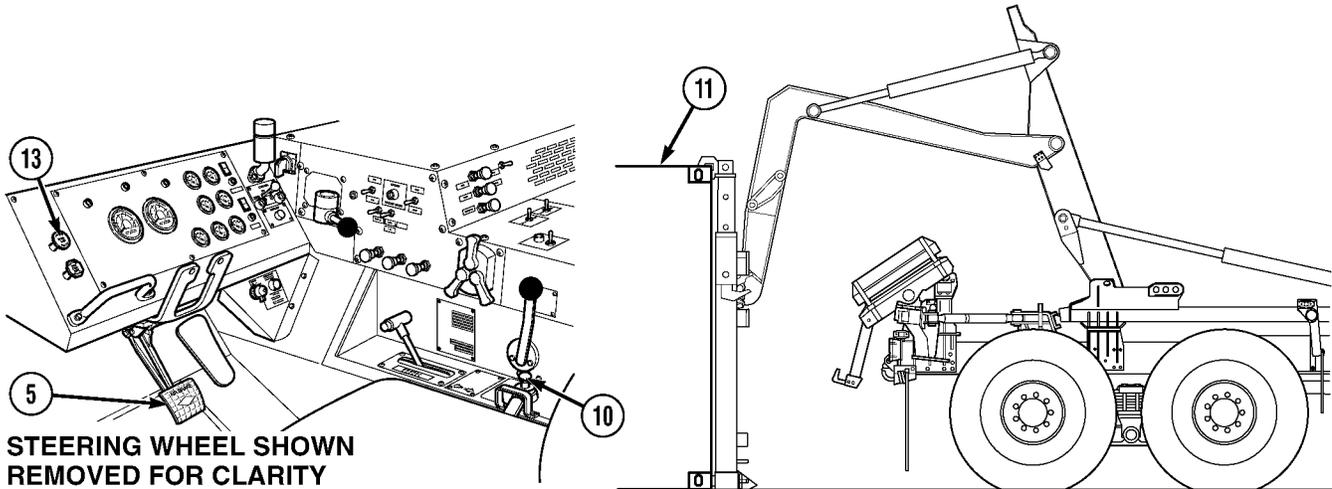

CAUTION

Once truck's rear suspension has been relieved of container load, do not continue in UNLOAD position as possibility of jacking up the rear of truck with hook arm may occur and damage to equipment may result.

NOTE

- If container is extremely light or empty, it may be necessary to place transmission range selector to D (Drive) and allow truck to move out from under container.
- LHS will only operate when transmission range selector is in N (Neutral)

- (13) Continue unloading until bottom of container (11) is on ground and rear suspension is unloaded.
- (14) Release joystick (10) when container (11) is resting on ground.
- (15) Pull out parking brake knob (13) to apply parking brakes.
- (16) Release service brake pedal (5).

Operating Instructions (Cont)

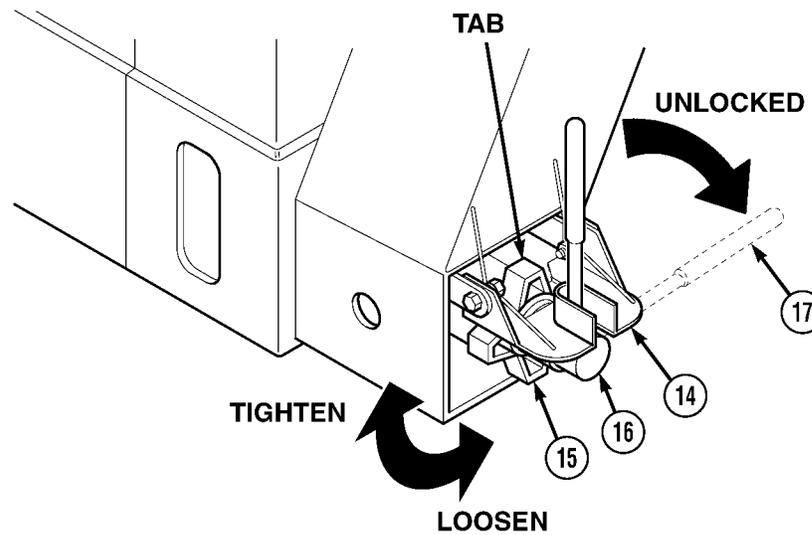
**WARNING**

Make sure that all tension has been relieved between LHS hook and front lift adapter prior to unlocking front lift adapter lower container locks. Stay clear of front lift adapter when unlocking front lift adapter lower container locks as front lift adapter may separate from container unexpectedly. Failure to comply may result in serious injury or death to personnel.

NOTE

There are two adapter lower container locks. Right side shown.

- (17) Raise handle lock plate (14) and turn handnut (15) counterclockwise to loosen stem (16).

NOTE

Make sure tab on handnut faces up.

- (18) Rotate lower container lock handle (17) toward center of truck to unlocked position.
 (19) Turn handnut (15) clockwise to tighten stem (16).
 (20) Release handle lock plate (14) over container lock handle (17) and handnut (15) tab.
 (21) Repeat steps (17) through (20) for left side.

Operating Instructions (Cont)

2-10.2 LOADING AND UNLOADING CONTAINER (82 INCHES [208 CM] OR TALLER) TO TRUCK USING FRONT LIFT ADAPTER (FLA) (CONT).

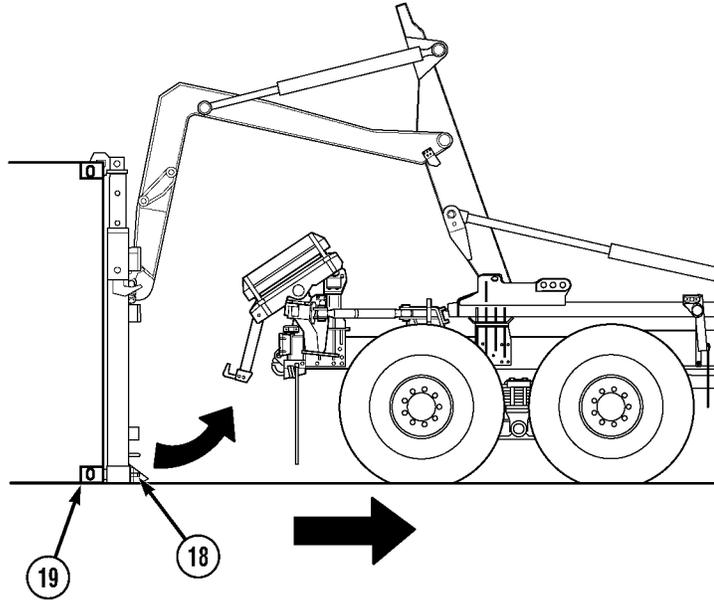
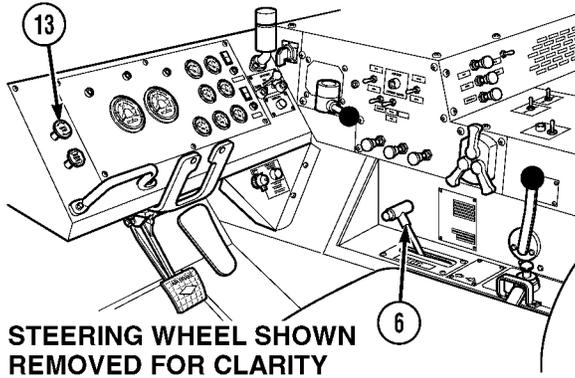

- (22) Push in parking brake knob (13) and release parking brakes. Set transmission range selector (6) to D (Drive).
- (23) Move truck forward until lower container locks (18) disengage from lower front corner castings (19) approximately 4 to 6 in. (10 to 15 cm).

Operating Instructions (Cont)

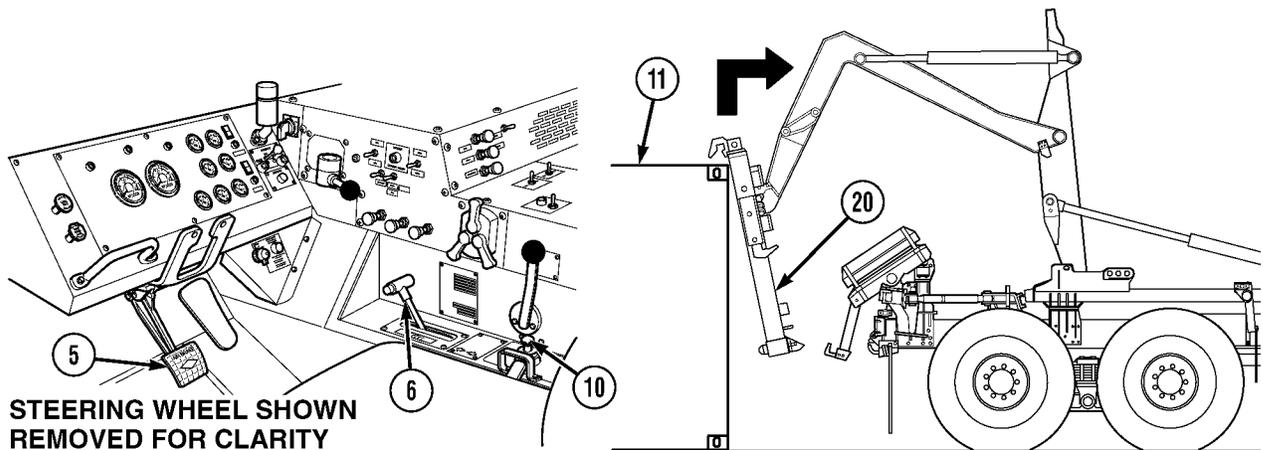

STEERING WHEEL SHOWN
REMOVED FOR CLARITY

CAUTION

Make sure that slide arm upper front hooks are completely disengaged and do not hang up in container upper corner castings when retracting LHS. Failure to comply may result in damage to the slide arm upper front hooks and/or container.

- (24) Apply service brake pedal (5) and set transmission range selector (6) to N (Neutral).

NOTE

- It may be necessary to move the truck forward or backward slightly to get the slide arm upper front hooks to disengage.
 - LHS will only operate when transmission range selector is in N (Neutral).
- (25) Move joystick (10) to LOAD position until front lift adapter (20) is disengaged from container (11).

Operating Instructions (Cont)

2-10.2 LOADING AND UNLOADING CONTAINER (82 INCHES [208 CM] OR TALLER) TO TRUCK USING FRONT LIFT ADAPTER (FLA) (CONT).

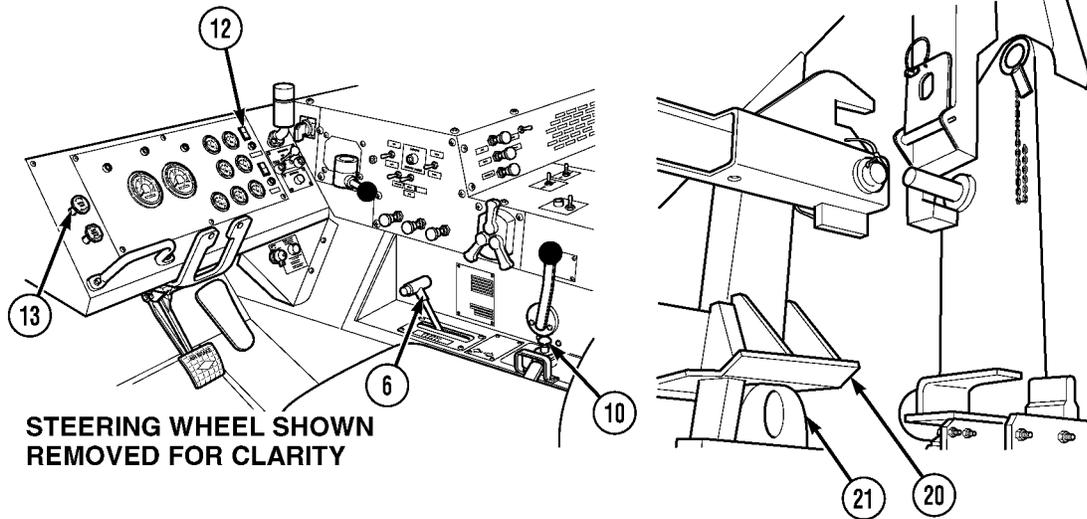

- (26) Release joystick (10).
- (27) Set transmission range selector (6) to N (Neutral) and pull out parking brake knob (13) to apply parking brakes.

CAUTION

- On steep downgrades, contact is possible between the front lift adapter lower legs and the rear sliders during empty LHS cycles. If contact appears likely, switch hydraulic selector to MAN H.A. position and retract (LOAD) hook arm a few inches. Switch hydraulic selector to MAN M.F. position and retract the main frame until the front lift adapter clears the rear sliders. Return hydraulic selector to AUTO and continue (LOAD) operation. Failure to comply may result in damage to equipment.
- Never drive with LHS NO TRANS lamp illuminated. An illuminated lamp means that the LHS is not fully stowed. Failure to comply may result in damage to equipment.

NOTE

The amount of time to load and unload is controlled by engine speed. Engine speed can be increased to approximately 1500 rpm to reduce loading and unloading times.

- (28) Move joystick (10) to LOAD position until LHS is fully retracted and front lift adapter (20) is positioned on bumper supports (21). LHS NO TRANS lamp (12) will go off, indicating LHS is in transport position.
- (29) Release joystick (10).

Operating Instructions (Cont)

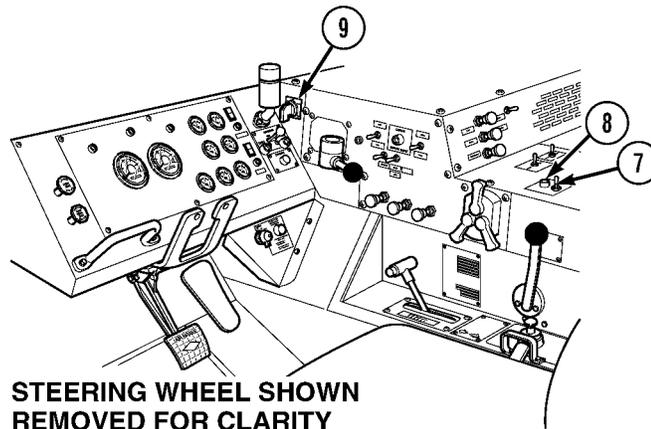
**CAUTION**

- Engine speed must be at idle before using hydraulic selector switch, or damage to equipment may result.
- Hydraulic selector switch must be in the OFF position before driving truck, or hydraulic system could overheat.

(30) Turn hydraulic selector switch (9) to OFF.

(31) Put PTO ENGAGE switch (7) in OFF position. Make sure indicator light (8) goes off.

Operating Instructions (Cont)

2-10.3 LOADING AND UNLOADING CONTAINER (72 INCHES [183 CM] OR TALLER) TO TRUCK USING FRONT LIFT ADAPTER (FLA).

a. Loading.

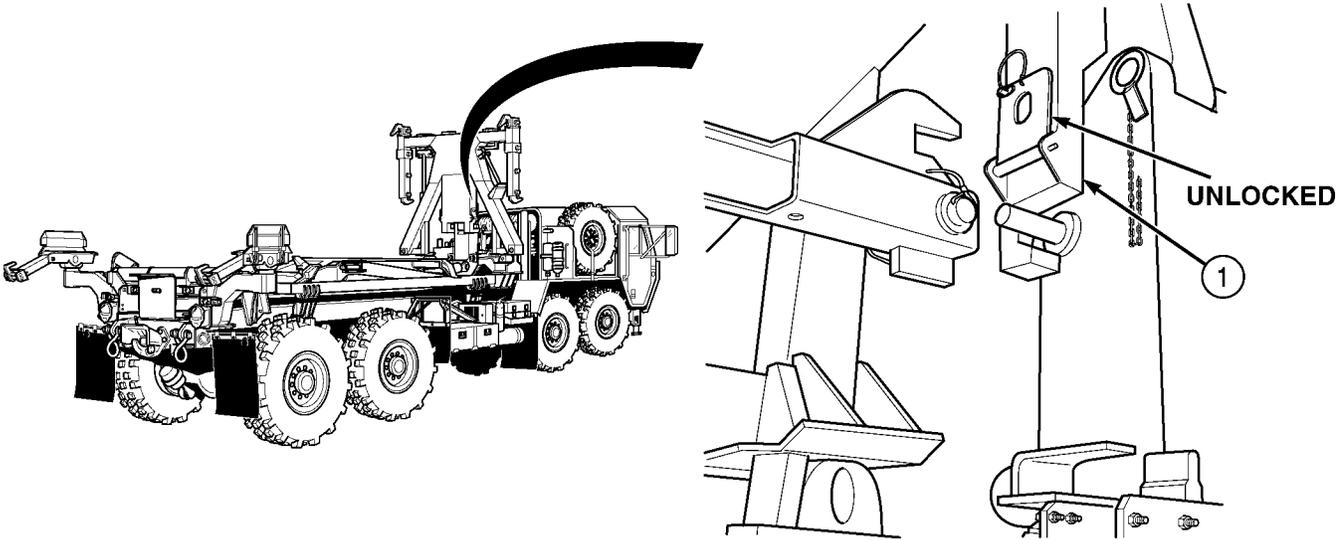

WARNING

Front lift adapter weighs 1,600 lbs. (726 kg). Personnel must stay clear when installing or removing front lift adapter to LHS hook arm hook. Failure to comply may result in injury or death to personnel.

CAUTION

Make sure front lift adapter is in the unlocked position before attempting to load a container to truck. Failure to comply will result in damage to equipment.

- (1) Make sure front lift adapter (1) is unlocked (Para 2-10.6).

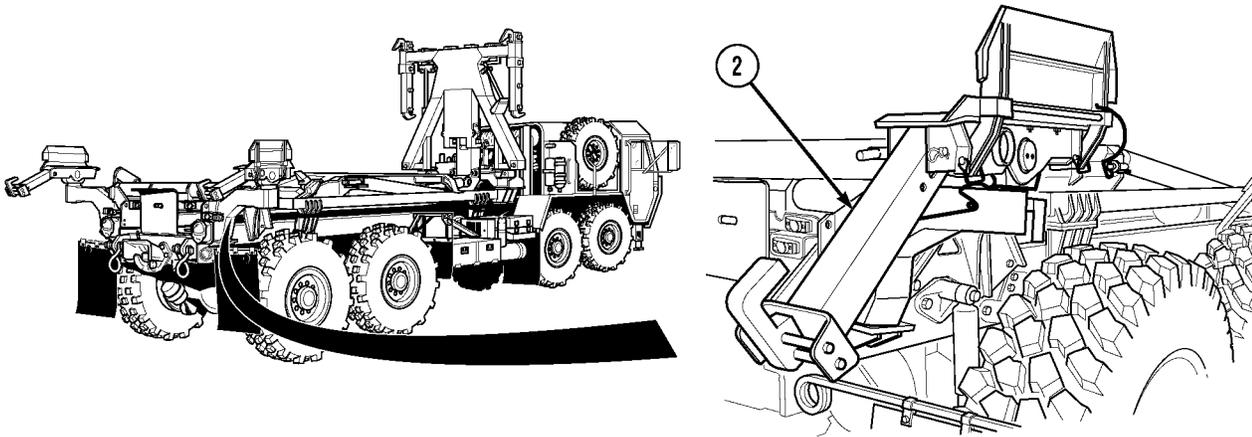

- (2) Make sure rear container lock (2) is in ready mode, refer to (Para 2-10.1).

Operating Instructions (Cont)

WARNING

- Check for overhead power lines or other obstructions before attempting LHS operations. LHS reaches a height of 18-ft. (5.5 m). Injury or death could result if LHS contacts power lines.
- Two personnel must be used (driver and spotter) to position front lift adapter (FLA). Failure to comply may result in damage to equipment and injury or death to personnel.
- Maximum permissible gross container weight is 24,000 lbs. (10 886 kg).
- Use caution when working around front lift adapter. Front lift adapter may swing unexpectedly when not attached to container. Failure to comply may result in injury or death to personnel.
- Do not stand between front lift adapter and container. Truck could roll, crushing personnel, causing serious injury or death.
- Do not attempt loading or unloading operations on a side slope greater than 5 degrees and/or fore/aft slope greater than 20 percent. Before attempting loading or unloading operations on slopes, determine if ground surface conditions permit safe loading or unloading operations. Slopes that contain snow, ice, loose gravel or sand may not permit safe loading or unloading.

CAUTION

- Use extreme caution when loading/unloading container with side doors. Container must remain centered during loading/unloading or flanges on side may be damaged and/or door hinges may make hard contact with guides.
- When operating CHU with nonstandard, end-opening, 20-ft.-long shipping containers, operator needs to take extra care to make sure that sliders and guides contact container properly, container slides on sliders properly, and container loads centered on truck. Failure to comply can result in container getting hung up or making hard contact with sliders and guides, causing damage to CHU or container.

NOTE

- For detailed instructions on how to operate the LHS, refer to “LHS Controls and Indicators” (Para 2-1), “Picking Up a Flatrack in Auto Mode” (Para 2-9 b), and “Off-Loading Flatrack in Auto Mode” (Para 2-9 c).
- Rear mud flaps may be pinned up to provide better visibility of front lift adapter lower container locks.
- Multiple connected containers cannot be used with CHU. This includes Six CONS and Quad CONS.

Operating Instructions (Cont)

2-10.3 LOADING AND UNLOADING CONTAINER (72 INCHES [183 CM] OR TALLER) TO TRUCK USING FRONT LIFT ADAPTER (FLA) (CONT).

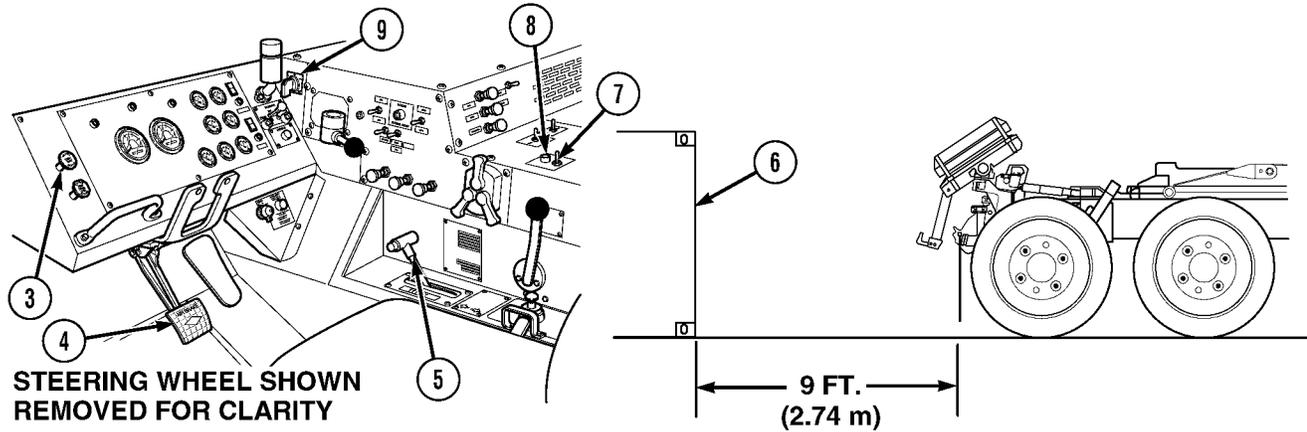

- (3) Start engine (TM 9-2320-279-10).
- (4) Push in parking brake knob (3), apply service brake pedal (4), and set transmission range selector (5) to R (Reverse).
- (5) Release service brake pedal (4) and position rear of truck within 9 ft. (2.74 m) of front of container (6), aligning centerline of truck within 2 in. (5 cm) of container centerline.
- (6) Apply service brake pedal (4) and set transmission range selector (5) to N (Neutral).
- (7) Put PTO ENGAGE switch (7) in ON position. Make sure indicator light (8) comes on.

CAUTION

Engine speed must be at idle before using hydraulic selector switch, or damage to equipment may result.

- (8) Turn hydraulic selector switch (9) to AUTO.

Operating Instructions (Cont)

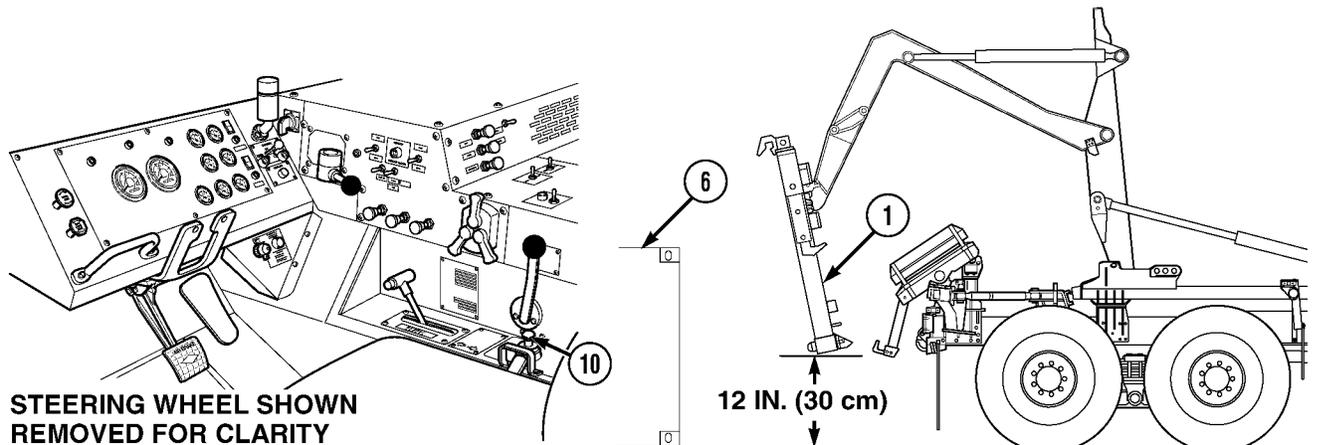
**CAUTION**

On steep downgrades, contact is possible between the front lift adapter lower legs and the rear sliders during empty LHS cycles. If contact appears likely, switch hydraulic selector to MAN H.A. position and retract (LOAD) hook arm a few inches. Return hydraulic selector to AUTO and continue (UNLOAD) operation. Repeat as required. Failure to comply may result in damage to equipment.

- (9) Move joystick (10) to UNLOAD position until front lift adapter (1) is positioned in front of container (6).
- (10) Operate LHS in AUTO mode until front lift adapter (1) is approximately 12 in. (30 cm) off of ground.
- (11) Release joystick (10).
- (12) Shut off engine (TM 9-2320-279-10).

Operating Instructions (Cont)

2-10.3 LOADING AND UNLOADING CONTAINER (72 INCHES [183 CM] OR TALLER) TO TRUCK USING FRONT LIFT ADAPTER (FLA) (CONT).

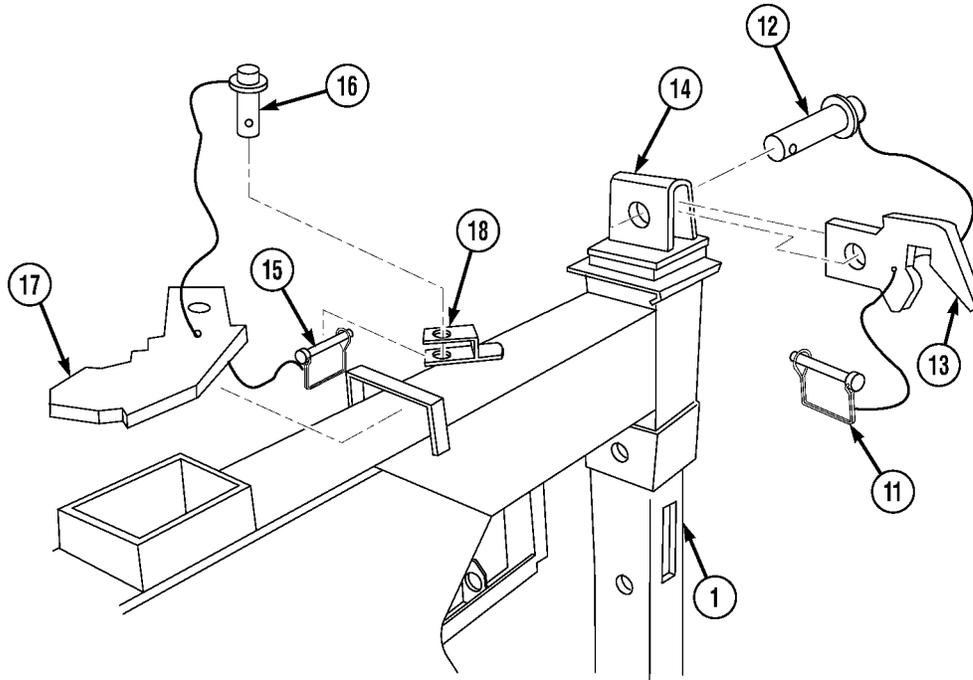

NOTE

- Refer to the front lift adapter data plate for the proper configuration needed for the height of each container being loaded.
- There are two slide arms. Right side shown.

(13) Remove lock pin (11), pin (12), and standard hook (13) from slide arm (14).

(14) Remove lock pin (15), pin (16), and 6-ft. hook (17) from stowage bracket (18) on front lift adapter (1).

Operating Instructions (Cont)

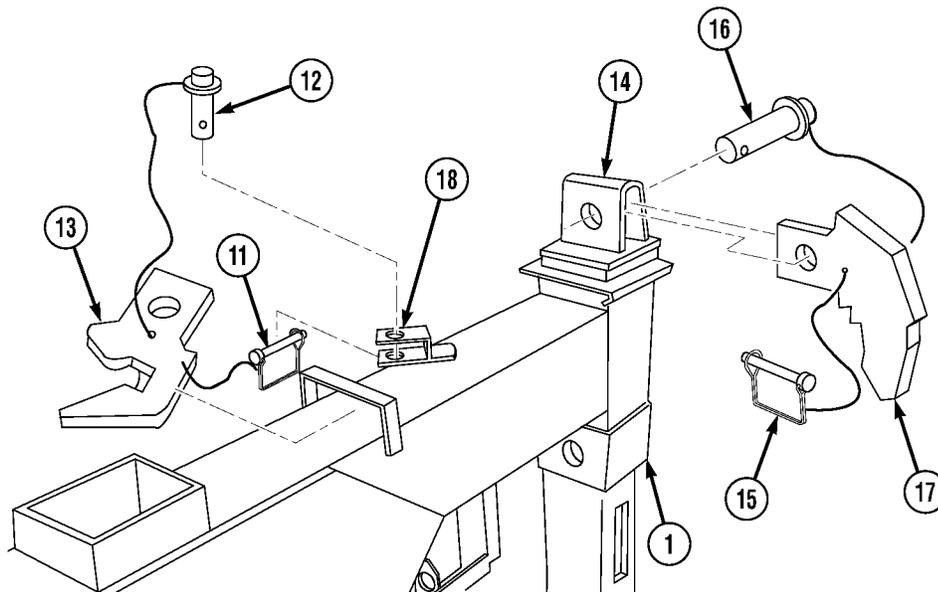

NOTE

Make sure 6-ft. hook faces down when installed.

- (15) Install 6-ft. hook (17), pin (16), and lock pin (15) in slide arm (14).
- (16) Install standard hook (13), pin (12), and lock pin (11) in stowage bracket (18) on front lift adapter (1).

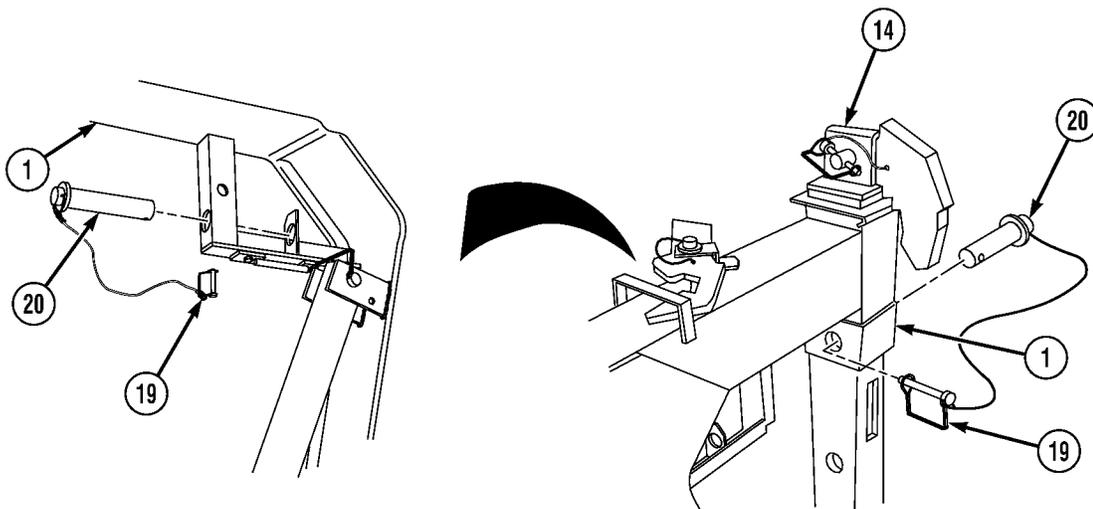

NOTE

If pin is in stowed position, perform steps (17) and (18).

- (17) Remove lock pin (19) and pin (20) from stow position on front lift adapter (1).
- (18) Install pin (20) and lock pin (19) in front lift adapter (1) and slide arm (14) in upper hole.
- (19) Repeat steps (13) through (18) for left side.

Operating Instructions (Cont)

2-10.3 LOADING AND UNLOADING CONTAINER (72 INCHES [183 CM] OR TALLER) TO TRUCK USING FRONT LIFT ADAPTER (FLA) (CONT).

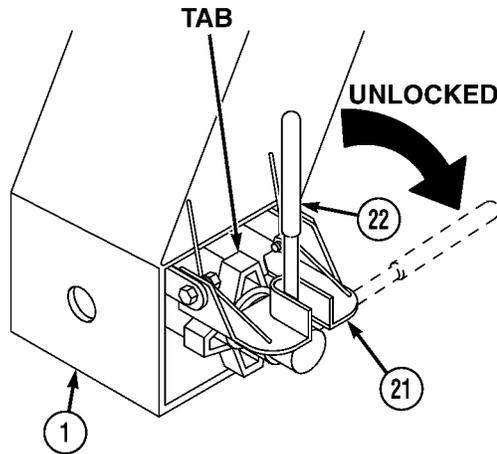

NOTE

- There are two front lift adapter lower container locks. Right side shown.
- Make sure front lift adapter lower container lock handle is positioned in slot on handle lock plate.
- Make sure tab on handnut faces up.

- (20) Raise handle lock plate (21) and rotate lower container lock handle (22) toward center of front lift adapter (1) to unlocked position.
- (21) Release handle lock plate (21) on front lift adapter (1).
- (22) Repeat steps (20) and (21) for left side.

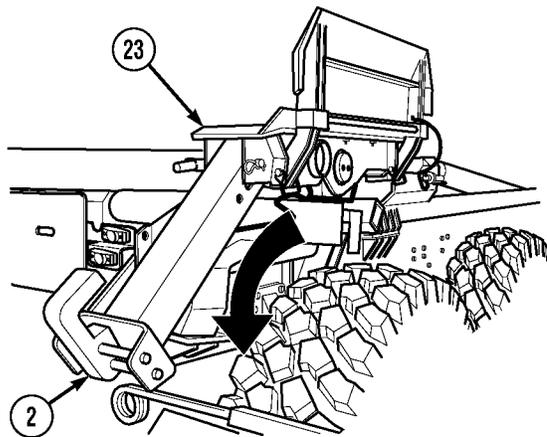

CAUTION

Make sure sliders are clear of debris and surfaces are properly greased, or damage to equipment may result.

NOTE

There are two rear sliders and container locks. Right side shown.

- (23) Rotate slider (23) so rear of slider faces down.
- (24) Make sure rear container lock (2) is in ready mode or down position (Para 2-10.1).
- (25) Repeat steps (23) and (24) for left side.

Operating Instructions (Cont)

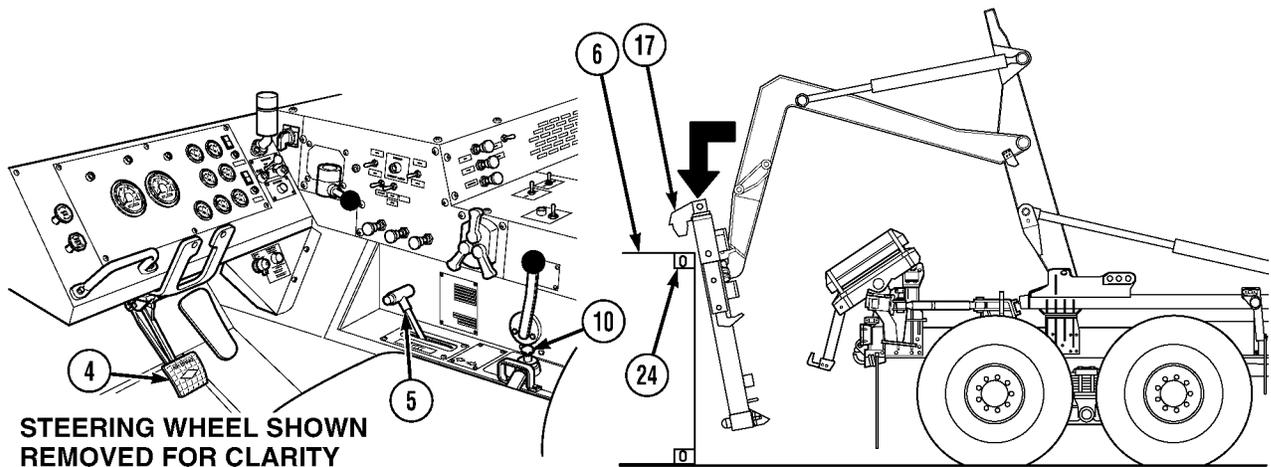

**STEERING WHEEL SHOWN
REMOVED FOR CLARITY**

- (26) Start engine (TM 9-2320-279-10).
- (27) Position slide arm 6-ft. hooks (17) just above and in front of container upper corner castings (24).
- (28) Apply service brake pedal (4) and set transmission range selector (5) to R (Reverse).

WARNING

Do not allow front lift adapter to contact the ground when slide arm 6-ft. (5.5 m) hooks are not engaged with container upper corner castings. Failure to comply may result in damage to equipment and injury or death to personnel.

- (29) Release service brake pedal (4) and slowly back up to approximately 12 in. (30 cm) from front of container (6).

NOTE

LHS will only operate when transmission range selector is in N (Neutral).

- (30) Apply service brake pedal (4), set transmission range selector (5) to N (Neutral), move joystick (10) to LOAD and raise front lift adapter until slide arm 6-ft. (5.5 m) hooks (17) are above container upper corner castings (24).

CAUTION

Make sure slide arm 6-ft. hooks are fully engaged with container upper corner castings. Failure to comply may result in damage to equipment.

NOTE

- To get slide arm 6-ft. hooks to properly seat it may be necessary to drive truck forward slightly.
 - When container is on side slope, it may be difficult to get both upper hooks properly seated. front lift adapter hangs level. To get front lift adapter to hang closer to same angle as container, it may be necessary to temporarily remove one rear container lock from slider and stow on downhill side of front lift adapter.
- (31) Release service brake pedal (4) and, moving joystick (10) to UNLOAD, lower slide arm 6-ft. hooks (17) into container upper corner castings (24).
 - (32) Apply service brake pedal (4) and set transmission range selector (5) to R (Reverse).

Operating Instructions (Cont)

2-10.3 LOADING AND UNLOADING CONTAINER (72 INCHES [183 CM] OR TALLER) TO TRUCK USING FRONT LIFT ADAPTER (FLA) (CONT).

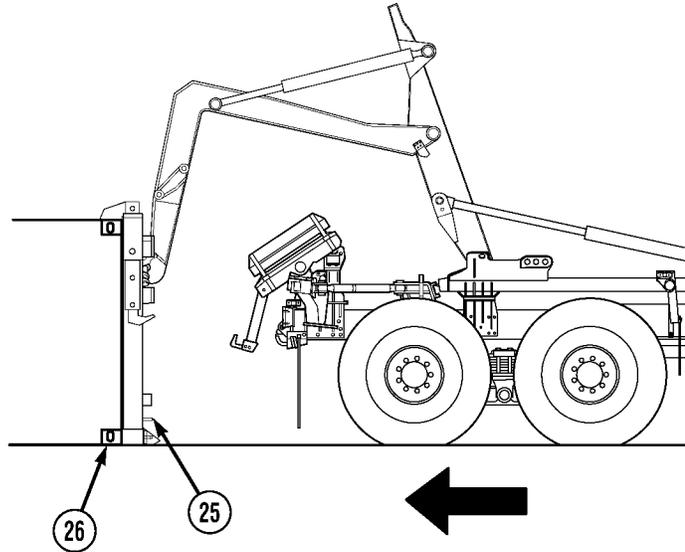
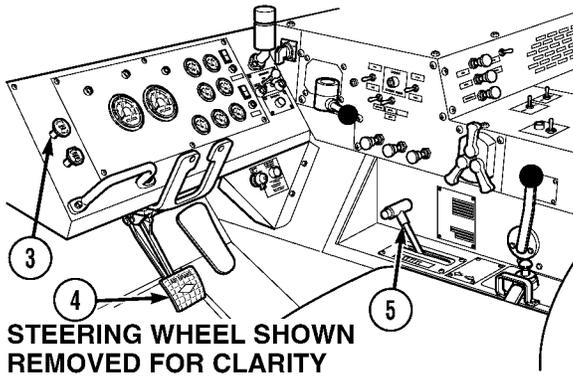

- (33) Back truck up until lower container locks (25) are seated in container lower front corner castings (26).
- (34) Apply service brake pedal (4), set transmission range selector (5) to N (Neutral), and pull out parking brake knob (3) to apply parking brakes.

Operating Instructions (Cont)

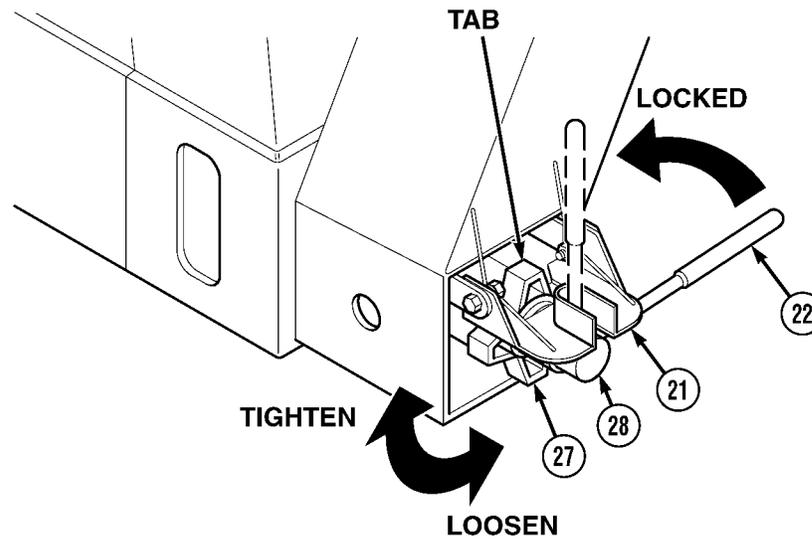
**CAUTION**

Make sure lower container locks are fully engaged with container lower front corner castings. Failure to comply may result in damage to equipment.

NOTE

- To get container lock handle to rotate, it may be necessary to loosen handnut.
- There are two lower container locks. Right side shown.
- After tightening handnut, it may be necessary to loosen handnut slightly to align tab with handle lock plate.
- Make sure lower container lock handle is secured in slot on handle lock plate.

- (35) Hold handle lock plate (21) up and rotate lower container lock handle (22) up in the locked position.
- (36) Turn handnut (27) clockwise and tighten stem (28).

Operating Instructions (Cont)

2-10.3 LOADING AND UNLOADING CONTAINER (72 INCHES [183 CM] OR TALLER) TO TRUCK USING FRONT LIFT ADAPTER (FLA) (CONT).

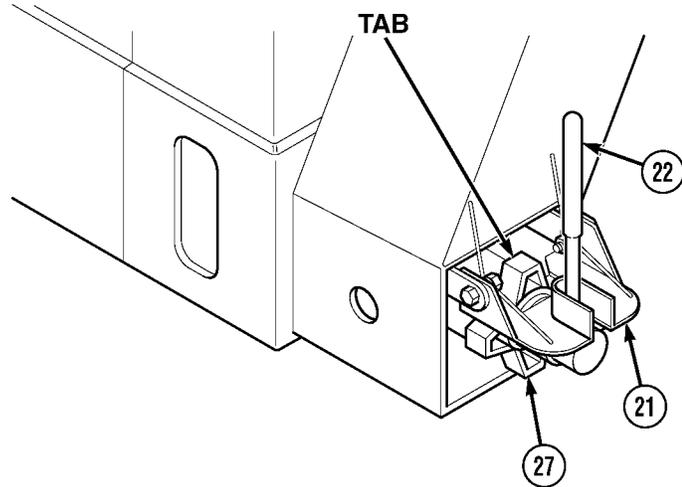
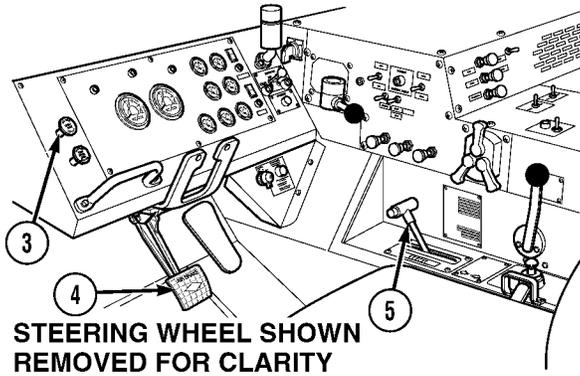

NOTE

Make sure tab on handnut faces up.

- (37) Lower handle lock plate (21) over lower container lock handle (22) and handnut (27) tab.
- (38) Repeat steps (35) through (37) for left side.
- (39) Set the transmission range selector (5) in N (Neutral), push in parking brake knob (3) to release parking brakes, and release service brake pedal (4).

Operating Instructions (Cont)

WARNING

When loading or unloading containers on uneven ground (side slope up to 5 degrees and downgrades up to 20 percent), it may be necessary to apply truck service brakes to prevent truck rollaway or severe injury or death could result.

CAUTION

- If LHS OVER LOAD indicator illuminates but loading operation continues, operator is cautioned that LHS is nearing maximum capacity. In this situation, operator should notify supervisor if it appears payload is unevenly distributed in container or if container load exceeds 24,000 lbs. (10 886 kg). If any of these conditions exist, payload must be redistributed or reduced, or damage to equipment may result.
- Load must be evenly distributed in the container. Uneven load distribution may cause the LHS OVER LOAD indicator to give false signals and cause the LHS to operate incorrectly. Damage to equipment may result.
- If LHS OVER LOAD indicator illuminates and normal operation has stopped, return load to original position and notify supervisor to have payload redistributed or weight reduced. Failure to comply may result in damage to equipment.
- Make sure parking brake is not applied before starting load sequence, or damage to equipment may occur.

NOTE

- The amount of time to load and unload is controlled by engine speed. Engine speed can be increased to approximately 1500 rpm to reduce loading and unloading times.
- If container is extremely light or empty, it may be necessary to place transmission range selector to R (Reverse) and allow truck to roll under container.
- If container is not centered, and transit locks cannot be installed and pinned, repeat steps (39) through (48) to reposition container.
- LHS will only operate when transmission range selector is in N (Neutral).

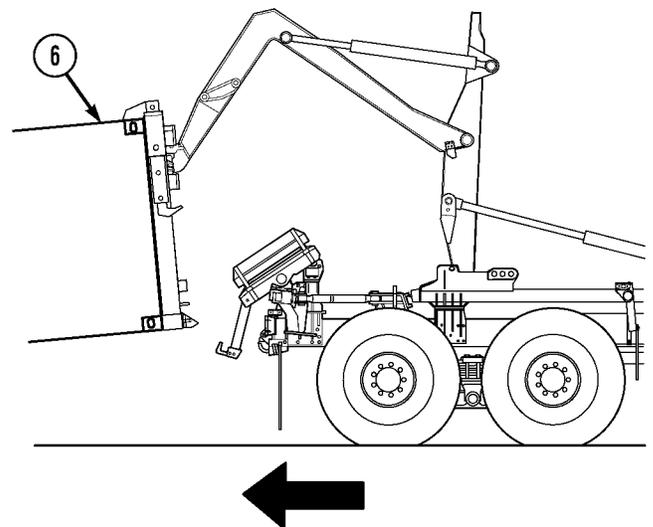
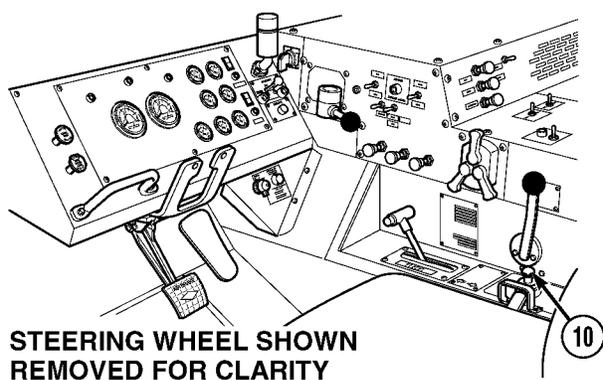

(40) Move joystick (10) to LOAD, allowing truck to be pulled under container (6).

Operating Instructions (Cont)

2-10.3 LOADING AND UNLOADING CONTAINER (72 INCHES [183 CM] OR TALLER) TO TRUCK USING FRONT LIFT ADAPTER (FLA) (CONT).

WARNING

Make sure that container has contacted rear sliders correctly and is between guides. Failure to comply may result in serious injury or death to personnel and damage to equipment.

CAUTION

Reduce engine speed to idle before container contacts rear sliders, or damage to equipment may result.

NOTE

- LHS OVER LOAD indicator may illuminate when lifting container from unusual conditions.
- As load is lifted, truck will be pulled under container. Some steering wheel adjustment may have to be made to make sure that container contacts rear sliders correctly and is between guides.

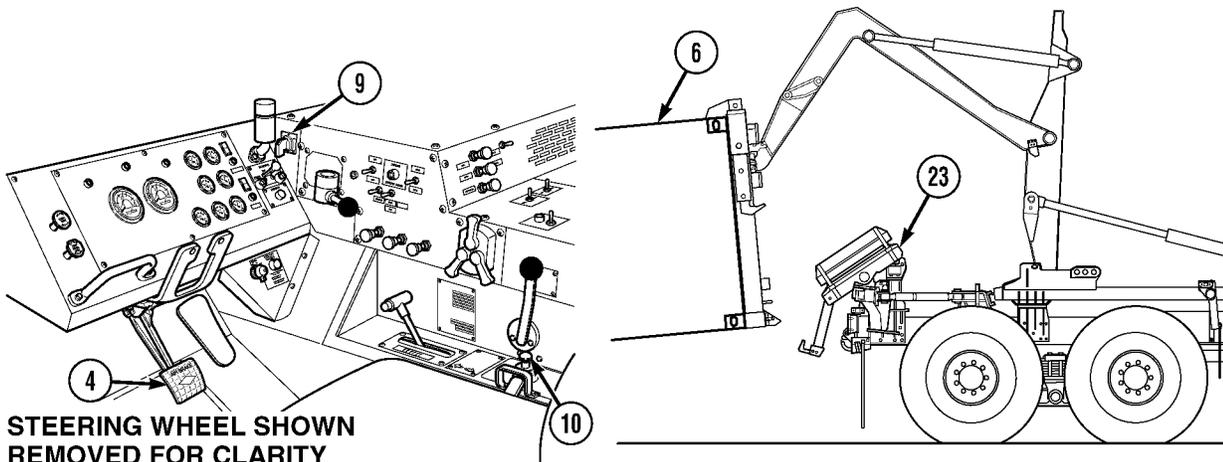

STEERING WHEEL SHOWN REMOVED FOR CLARITY

- (41) As container (6) contacts rear sliders (23), reduce engine speed to idle and apply service brake pedal (4).

CAUTION

Engine speed must be at idle before using hydraulic selector switch, or damage to equipment may result

NOTE

If container is being loaded in soft soil conditions, perform steps (42) through (44).

- (42) Release joystick (10). Set hydraulic selector switch (9) to MAN H.A. position.

Operating Instructions (Cont)

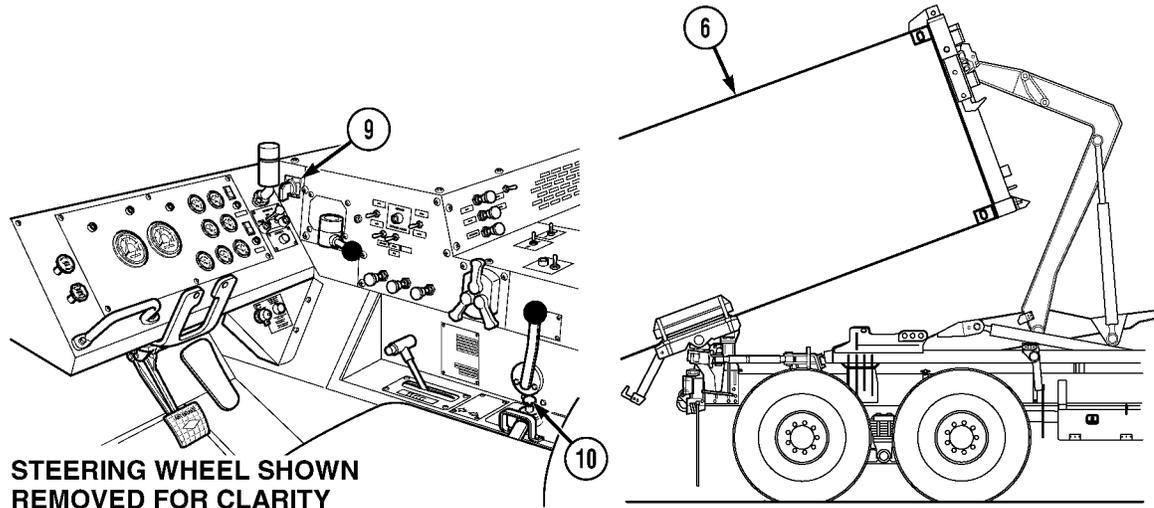

- (43) Move joystick (10) to LOAD until container (6) is approximately 2 ft. (0.61 m) off the ground. Release joystick.

CAUTION

Engine speed must be at idle before using hydraulic selector switch, or damage to equipment may result

- (44) Set hydraulic selector switch (9) to AUTO. Resume normal AUTO operations.

Operating Instructions (Cont)

2-10.3 LOADING AND UNLOADING CONTAINER (72 INCHES [183 CM] OR TALLER) TO TRUCK USING FRONT LIFT ADAPTER (FLA) (CONT).

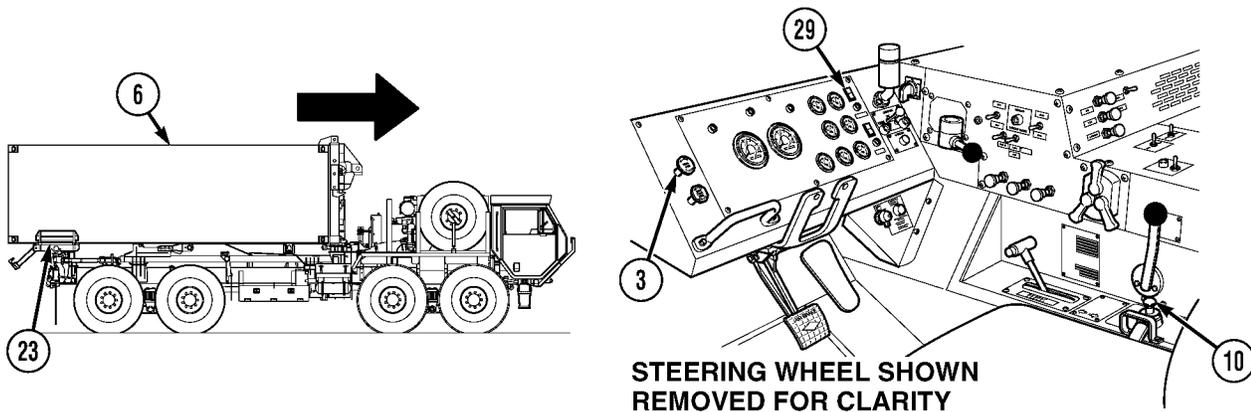

NOTE

Engine speed may be increased and decreased to ease loading.

- (45) After container (6) contacts rear sliders (23), increase engine speed to approximately 1500 rpm until container is almost loaded. Reduce engine speed to idle.
- (46) Continue loading until container (6) is fully loaded and LHS NO TRANS lamp (29) goes out.
- (47) Release joystick (10).
- (48) Pull out parking brake knob (3) and apply parking brake.

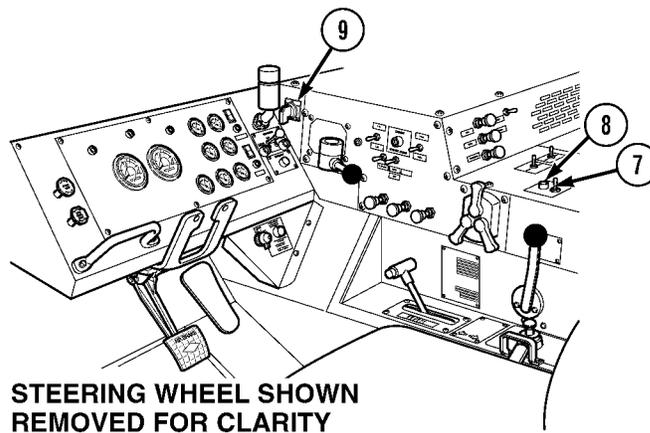

CAUTION

- Engine speed must be at idle before using hydraulic selector switch, or damage to equipment may result.
- Hydraulic selector switch must be in the OFF position before driving truck, or hydraulic system could overheat.

- (49) Turn hydraulic selector switch (9) to OFF.
- (50) Put PTO ENGAGE switch (7) in OFF position. Make sure indicator light (8) goes off.
- (51) Shut off engine (TM 9-2320-279-10).

Operating Instructions (Cont)

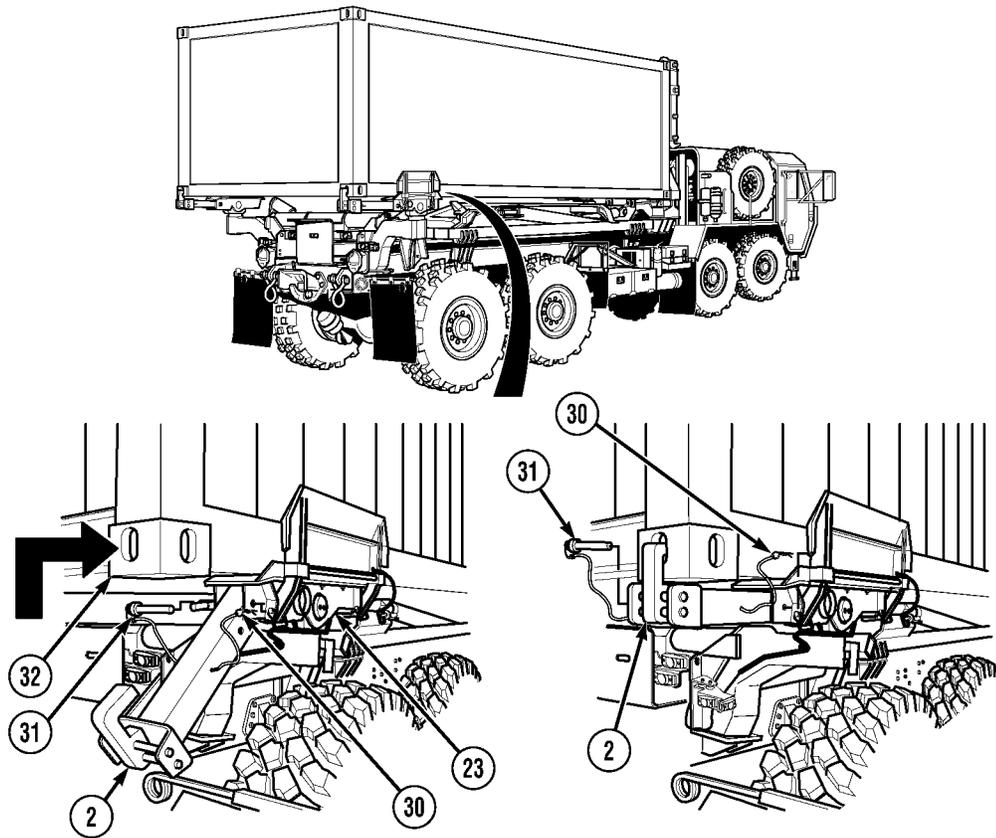
**NOTE**

- There are two rear container locks. Right side shown.
- If container is not centered, and transit locks cannot be installed and pinned, repeat steps (40) through (51) to reposition container.

- (52) Support rear container lock (2) and remove lock pin (30) and pin (31).
 (53) Rotate rear container lock (2) up and position into container lower rear corner casting (32).
 (54) Install pin (31) and lock pin (30) in rear container lock (2) and slider (23).
 (55) Perform steps (52) through (54) for left side.

WARNING

- When loaded with a container, the center of gravity is moved up and toward rear of truck. Extreme caution must be taken when turning and ascending or descending on a grade. Failure to use extreme caution could result in severe injury or death to personnel.
- Maximum side slope when loaded with a container is 30 percent. Failure to comply may result in equipment damage or severe injury or death to personnel.
- Do not reduce tire pressure when loaded with FRS or container. Highway tire pressure, 60 psi (414 kPa) front and 83 psi (572 kPa) rear, is required at all times when loaded with FRS or container. Failure to comply could result in damage to equipment and severe injury or death to personnel.

Operating Instructions (Cont)

2-10.3 LOADING AND UNLOADING CONTAINER (72 INCHES [183 CM] OR TALLER) TO TRUCK USING FRONT LIFT ADAPTER (FLA) (CONT).

b. Unloading.

WARNING

- Check for overhead power lines or other obstructions before attempting LHS operations. LHS reaches a height of 18 ft. (5.5 m). Injury or death could result if LHS contacts power lines.
- Do not attempt loading or unloading operations on a side slope greater than 5 degrees and/or fore/aft slope greater than 20 percent. Before attempting loading or unloading operations on slopes, determine if ground surface conditions permit safe loading or unloading operations. Slopes that contain snow, ice, loose gravel, or sand may not permit safe loading or unloading.
- Check ground conditions for firmness and extreme sideways inclination before picking up or off-loading a container. Any ground instability beneath road wheels could cause serious injury or death to personnel.
- Prior to and during any load or unload cycle, all personnel should stay clear of LHS, front lift adapter, and containers, or serious injury or death may result.

CAUTION

- Check that ground conditions where container will be placed can support the container weight or damage to the container, front lift adapter or LHS may result.
- Use extreme caution when loading/unloading container with side doors. Container must remain centered during loading/unloading or flanges on side may be damaged and/or door hinges may make hard contact with guides.

NOTE

For detailed instructions on how to operate the LHS, refer to “LHS Controls and Indicators” (Para 2-1), “Picking Up a Flatrack in Auto Mode” (Para 2-9 b), and “Off-Loading Flatrack in Auto Mode” (Para 2-9 c).

- (1) Check area for operating room at front and rear of truck. Check overhead clearance and ground conditions.

Operating Instructions (Cont)

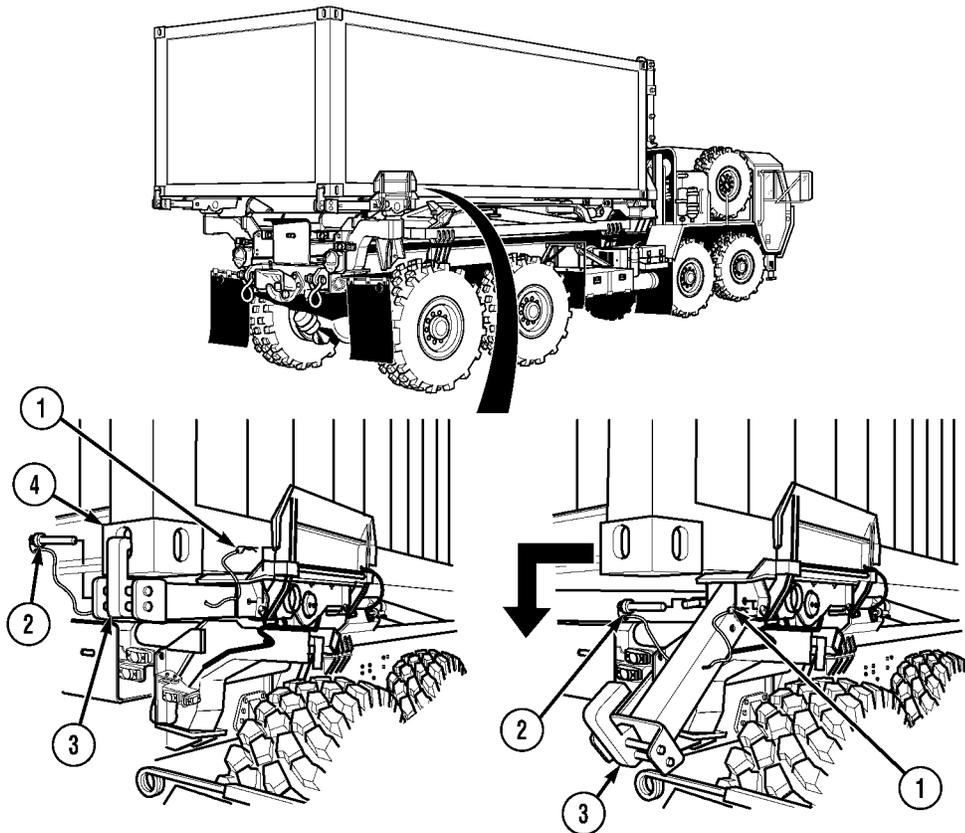

NOTE

There are two rear container locks. Right side shown.

- (2) Remove lock pin (1), pin (2), and rear container lock (3) from lower rear corner casting (4).
- (3) Rotate rear container lock (3) in down position and install pin (2) and lock pin (1).
- (4) Perform steps (2) and (3) for left side.

Operating Instructions (Cont)

2-10.3 LOADING AND UNLOADING CONTAINER (72 INCHES [183 CM] OR TALLER) TO TRUCK USING FRONT LIFT ADAPTER (FLA) (CONT).

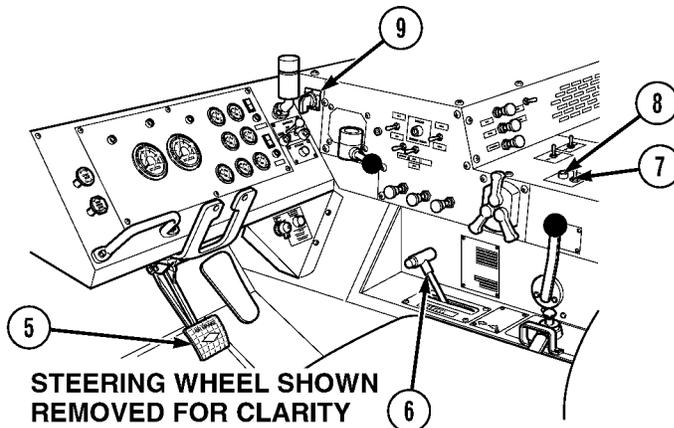

- (5) Start engine (TM 9-2320-279-10).
- (6) Apply service brake pedal (5) and set transmission range selector (6) to N (Neutral).
- (7) Put PTO ENGAGE switch (7) in ON position. Make sure indicator light (8) comes on.

CAUTION

Engine speed must be at idle before using hydraulic selector switch, or damage to equipment may result.

- (8) Turn hydraulic selector switch (9) to AUTO.

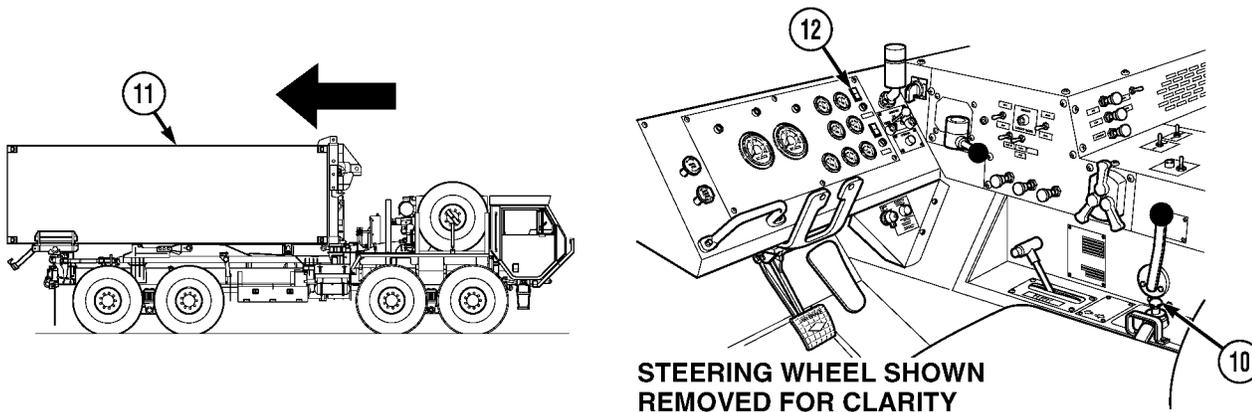

WARNING

When loading or unloading containers on uneven ground (side slope up to 5 degrees and downgrades up to 20 percent), it may be necessary to apply truck service brakes to prevent truck rollaway or severe injury or death could result.

NOTE

LHS will not operate and unload if rear container locks are engaged.

- (9) Move joystick (10) to UNLOAD. Container (11) will start to move rearward. LHS NO TRANS lamp (12) will illuminate. Maintain engine speed at idle until front of container raises approximately 12 in. (30 cm).

Operating Instructions (Cont)

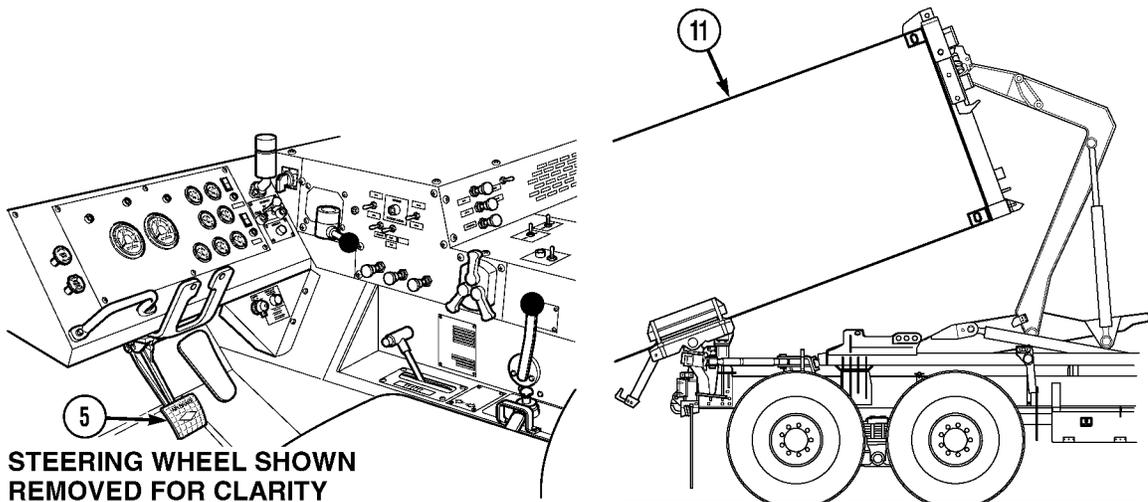

STEERING WHEEL SHOWN REMOVED FOR CLARITY

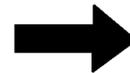

NOTE

The amount of time to load and unload is controlled by engine speed. Engine speed can be increased to approximately 1500 rpm to reduce loading and unloading times.

- (10) Continue to unload container (11) until back edge of container touches ground.
- (11) Release service brake pedal (5) and allow container (11) to push truck forward from under container.

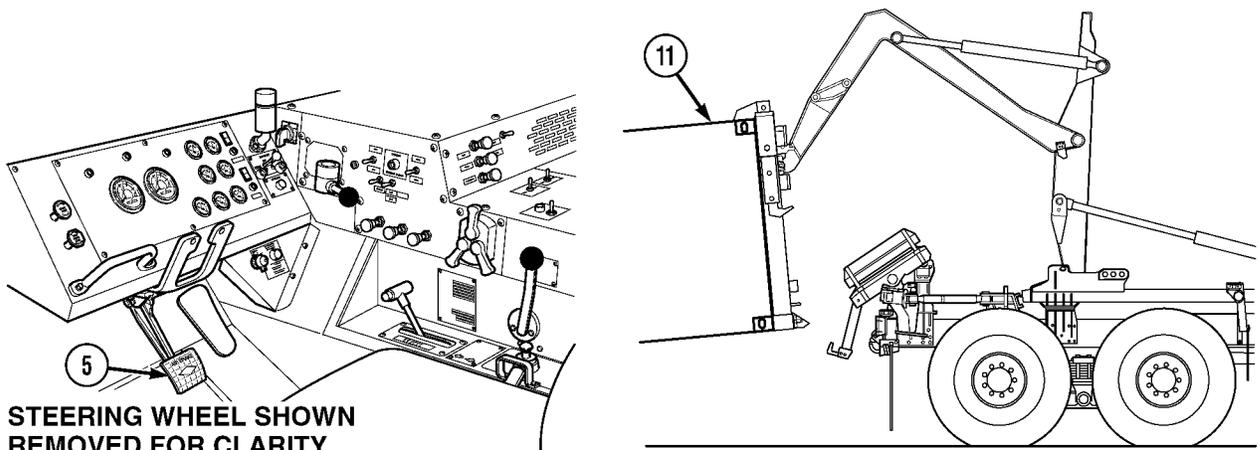

STEERING WHEEL SHOWN REMOVED FOR CLARITY

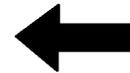

- (12) As front of container (11) approaches within approximately 8 in. (20.3 cm) of ground, decrease engine speed to idle and apply service brake pedal (5).

Operating Instructions (Cont)

2-10.3 LOADING AND UNLOADING CONTAINER (72 INCHES [183 CM] OR TALLER) TO TRUCK USING FRONT LIFT ADAPTER (FLA) (CONT).

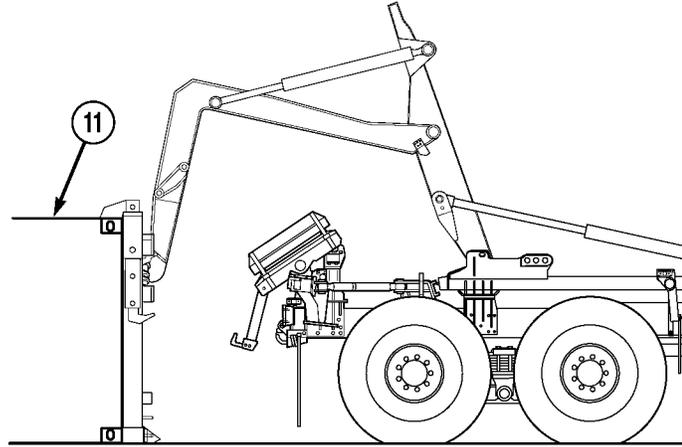
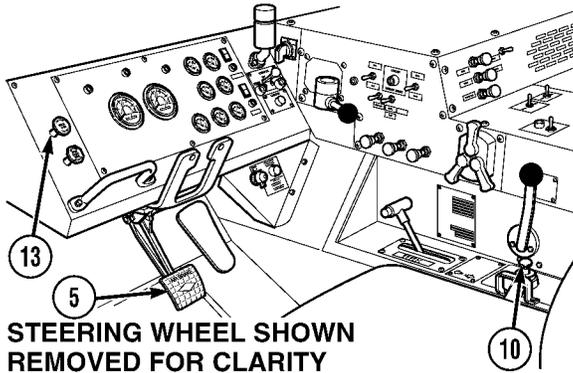

CAUTION

Once truck's rear suspension has been relieved of container load, do not continue in UNLOAD position as possibility of jacking up the rear of truck with hook arm may occur and damage to equipment may result.

NOTE

- If container is extremely light or empty, it may be necessary to place transmission range selector to D (Drive) and allow truck to move out from under container.
- LHS will only operate when transmission range selector is in N (Neutral).

- (13) Continue unloading until bottom of container (11) is on ground and rear suspension is unloaded.
- (14) Release joystick (10) when container (11) is resting on ground.
- (15) Pull out parking brake knob (13) to apply parking brakes.
- (16) Release service brake pedal (5).

Operating Instructions (Cont)

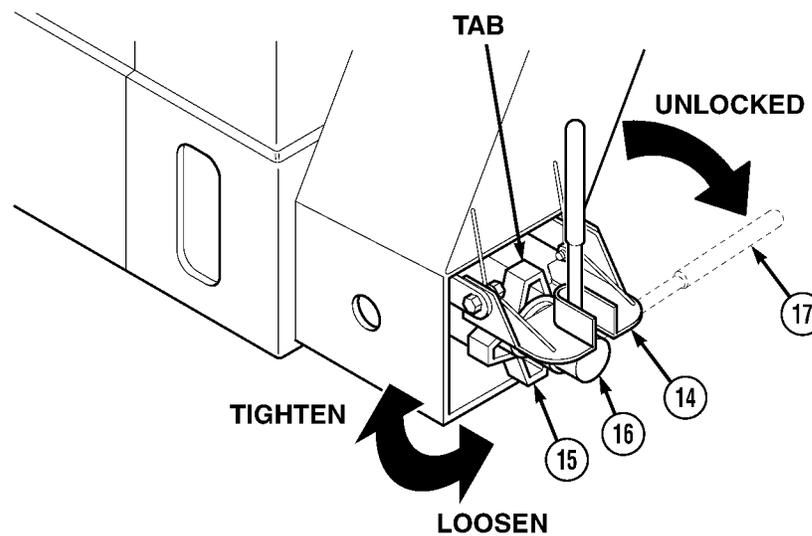
**WARNING**

Make sure that all tension has been relieved between LHS hook and front lift adapter prior to unlocking front lift adapter lower container locks. Stay clear of front lift adapter when unlocking front lift adapter lower container locks as front lift adapter may separate from container unexpectedly. Failure to comply may result in serious injury or death to personnel.

NOTE

There are two adapter lower container locks. Right side shown.

- (17) Raise handle lock plate (14) and turn handnut (15) counterclockwise and loosen stem (16).

NOTE

Make sure tab on handnut faces up.

- (18) Rotate lower container lock handle (17) toward center of truck to unlocked position.
 (19) Turn handnut (15) clockwise and tighten stem (16).
 (20) Release handle lock plate (14) over container lock handle (17) and handnut (15) tab.
 (21) Repeat steps (17) through (20) for left side.

Operating Instructions (Cont)

2-10.3 LOADING AND UNLOADING CONTAINER (72 INCHES [183 CM] OR TALLER) TO TRUCK USING FRONT LIFT ADAPTER (FLA) (CONT).

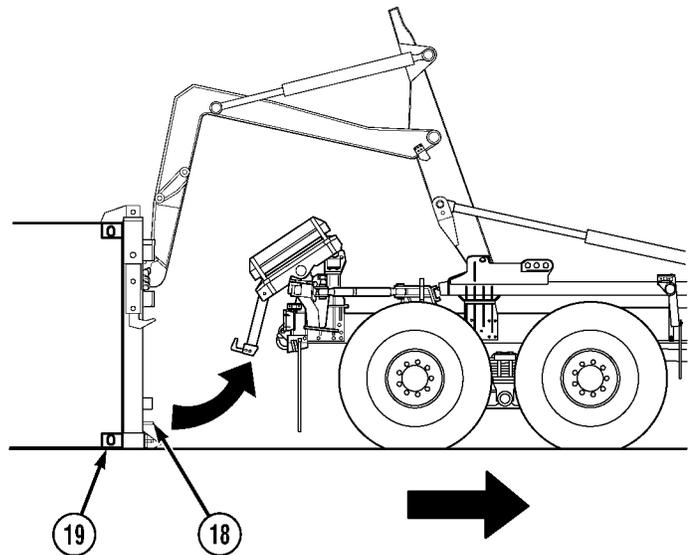
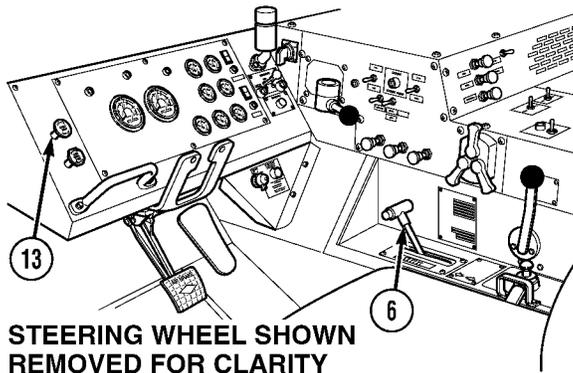

- (22) Push in parking brake knob (13) and release parking brakes. Set transmission range selector (6) to D (Drive).
- (23) Move truck forward until lower container locks (18) disengage from lower front corner castings (19) approximately 4 to 6 in. (10 to 15 cm).

Operating Instructions (Cont)

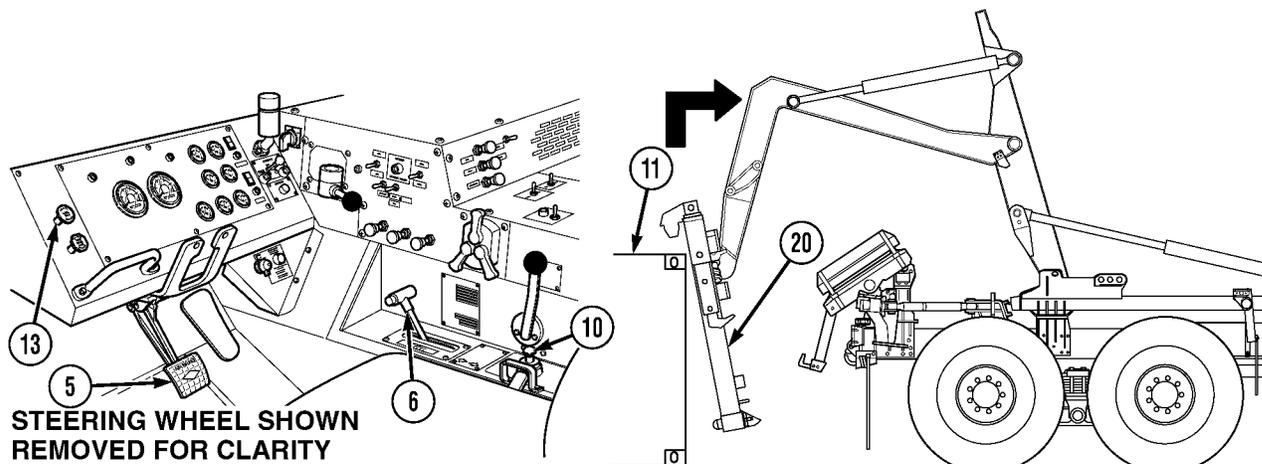
**CAUTION**

Make sure that the slide arm 6-ft. hooks are completely disengaged and do not hang up in container upper corner castings when retracting LHS. Failure to comply may result in damage to the slide arm 6-ft. hooks and/or container.

NOTE

- It may be necessary to move the truck forward or backward slightly to get the slide arm 6-ft. hooks to disengage.
- LHS will only operate when transmission range selector is in N (Neutral).

- (24) Move joystick (10) to LOAD position until front lift adapter (20) is disengaged from container (11).
- (25) Release joystick (10).
- (26) Move truck forward until rear of truck is approximately 9 ft. (2.74 m) in front of container (11).
- (27) Move joystick (10) to UNLOAD position until front lift adapter (20) is positioned approximately 12 in. (30 cm) off the ground.
- (28) Apply service brake pedal (5), set transmission range selector (6) to N (Neutral), and pull out parking brake knob (13) to apply parking brakes.

CAUTION

- On steep downgrades, contact is possible between the front lift adapter lower legs and the rear sliders during empty LHS cycles. If contact appears likely, switch hydraulic selector to MAN H.A. position and retract (LOAD) hook arm a few inches. Switch hydraulic selector to MAN M.F. position and retract the main frame until the front lift adapter clears the rear sliders. Return hydraulic selector to AUTO and continue (LOAD) operation. Failure to comply may result in damage to equipment.
- Never drive with LHS NO TRANS lamp illuminated. An illuminated lamp means that the LHS is not fully stowed. Failure to comply may result in damage to equipment.

Operating Instructions (Cont)

2-10.3 LOADING AND UNLOADING CONTAINER (72 INCHES [183 CM] OR TALLER) TO TRUCK USING FRONT LIFT ADAPTER (FLA) (CONT).

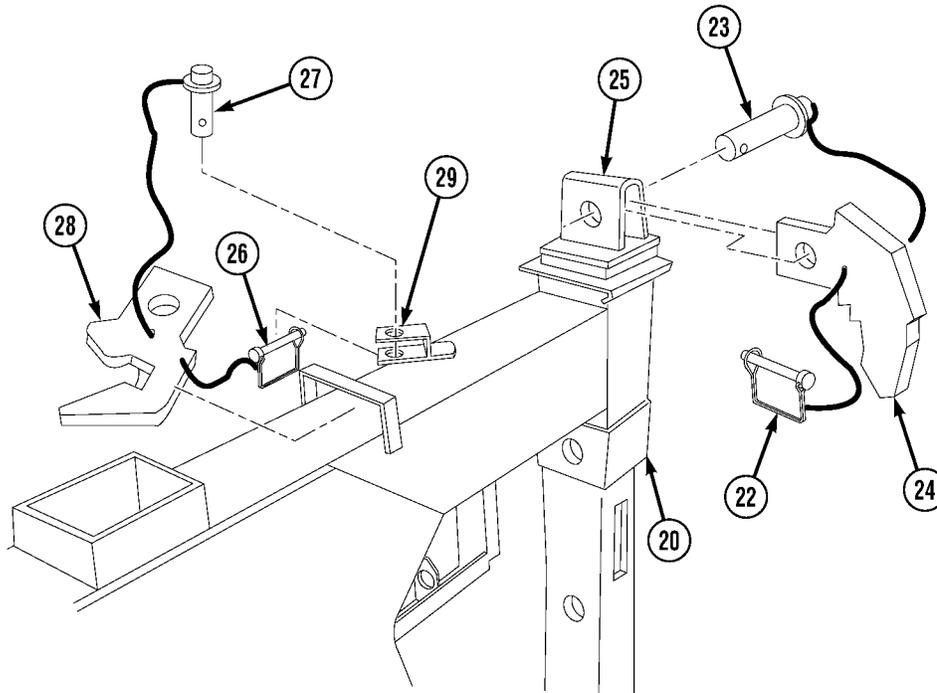

NOTE

- Perform steps (29) through (33) if remainder of CHU operation does not require use of 6-ft. hooks.
- There are two slide arms. Right side shown.

(29) Remove lock pin (22), pin (23), and 6-ft. hook (24) from slide arm (25).

(30) Remove lock pin (26), pin (27), and standard hook (28) from stowage bracket (29) on front lift adapter (20).

Operating Instructions (Cont)

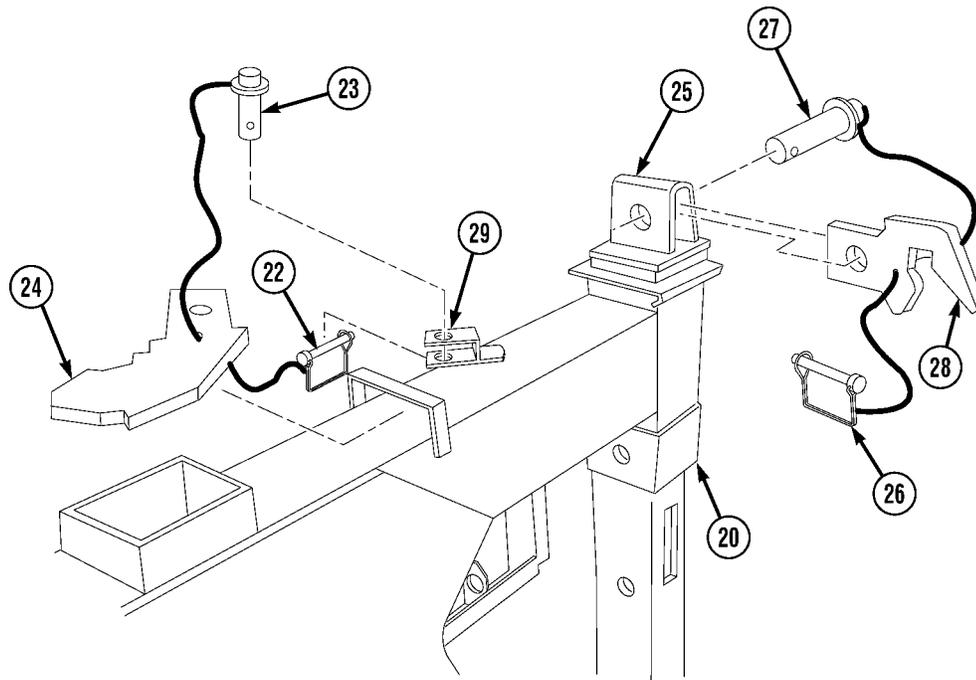
**NOTE**

Make sure standard hooks face down when installed.

- (31) Install standard hook (28), pin (27), and lock pin (26) on slide arm (25).
- (32) Install 6-ft. hook (24), pin (23), and lock pin (22) in stowage bracket (29) on front lift adapter (20).
- (33) Repeat steps (29) through (32) for left side.

Operating Instructions (Cont)

2-10.3 LOADING AND UNLOADING CONTAINER (72 INCHES [183 CM] OR TALLER) TO TRUCK USING FRONT LIFT ADAPTER (FLA) (CONT).

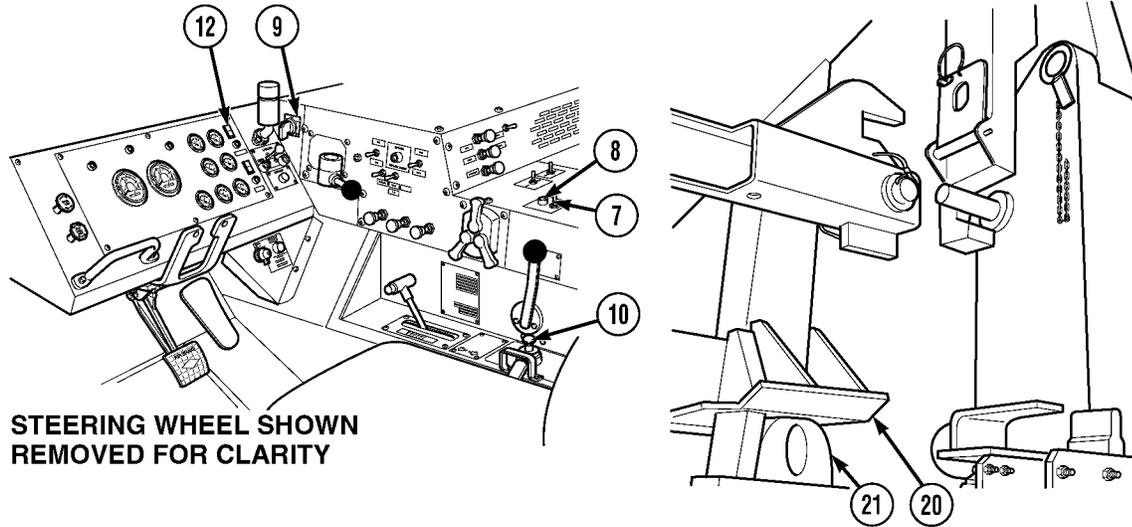

STEERING WHEEL SHOWN REMOVED FOR CLARITY

NOTE

The amount of time to load and unload is controlled by engine speed. Engine speed can be increased to approximately 1500 rpm to reduce loading and unloading times.

- (34) Move joystick (10) to LOAD position until LHS is fully retracted and front lift adapter (20) is positioned on bumper supports (21). LHS NO TRANS lamp (12) will go off, indicating LHS is in transport position.
- (35) Release joystick (10).

CAUTION

- Engine speed must be at idle before using hydraulic selector switch, or damage to equipment may result.
- Hydraulic selector switch must be in the OFF position before driving truck, or hydraulic system could overheat.

- (36) Turn hydraulic selector switch (9) to OFF.
- (37) Put PTO ENGAGE switch (7) in OFF position. Make sure indicator light (8) goes off.
- (38) Shut off engine (TM 9-2320-179-10).

Operating Instructions (Cont)

2-10.4 LOADING AND UNLOADING CONTAINER (51 INCHES [130 CM] OR TALLER) TO TRUCK USING FRONT LIFT ADAPTER (FLA).

a. Loading.

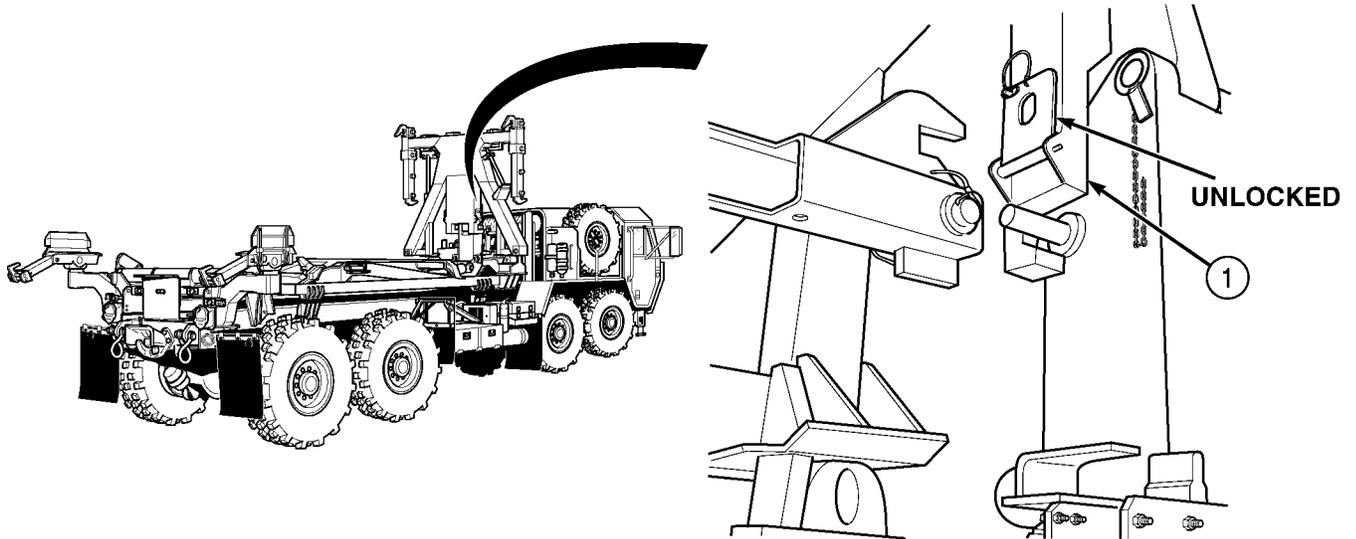

WARNING

Front lift adapter weighs 1,600 lbs. (726 kg). Personnel must stay clear when installing or removing front lift adapter to LHS hook arm hook. Failure to comply may result in injury or death to personnel.

CAUTION

Make sure front lift adapter is in the unlocked position before attempting to load a container to truck. Failure to comply will result in damage to equipment.

- (1) Make sure front lift adapter (1) is unlocked (Para 2-10.6).

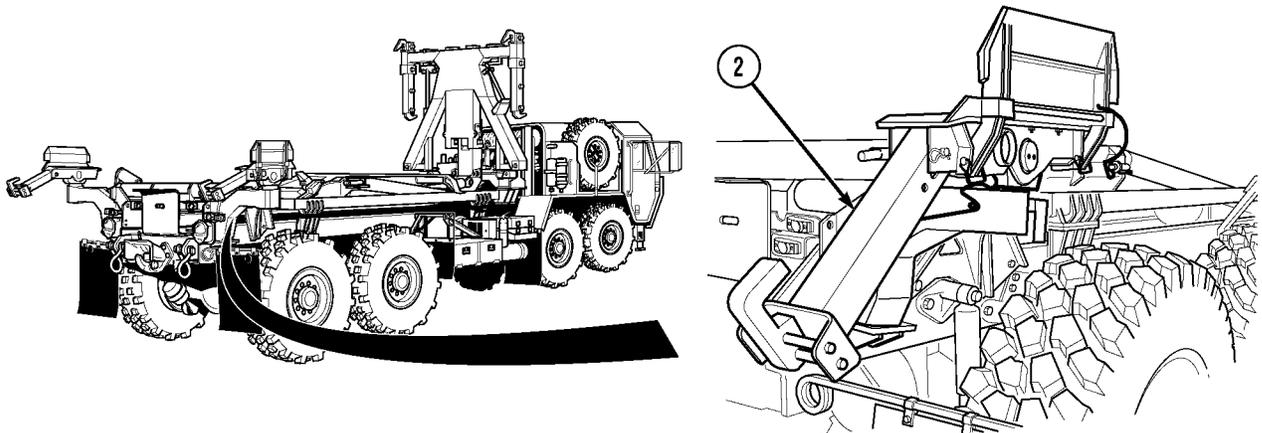

- (2) Make sure rear container lock (2) is in ready mode, refer to (Para 2-10.1).

Operating Instructions (Cont)

2-10.4 LOADING AND UNLOADING CONTAINER (51 INCHES [130 CM] OR TALLER) TO TRUCK USING FRONT LIFT ADAPTER (FLA) (CONT).

WARNING

- Check for overhead power lines or other obstructions before attempting LHS operations. LHS reaches a height of 18 ft. (5.5 m). Injury or death could result if LHS contacts power lines.
- Two personnel must be used (driver and spotter) to position front lift adapter (FLA) failure to comply may result in damage to equipment and injury or death to personnel.
- Maximum permissible gross container weight is 24,000 lbs. (10 886 kg).
- Use caution when working around front lift adapter. Front lift adapter may swing unexpectedly when not attached to container. Failure to comply may result in injury or death to personnel.
- Do not stand between front lift adapter and container. Truck could roll, crushing personnel causing serious injury or death.
- Do not attempt loading or unloading operations on a side slope greater than 5 degrees and/or fore/aft slope greater than 20 percent. Before attempting loading or unloading operations on slopes, determine if ground surface conditions permit safe loading or unloading operations. Slopes that contain snow, ice, loose gravel or sand may not permit safe loading or unloading.

CAUTION

- Use extreme caution when loading/unloading container with side doors. Container must remain centered during loading/unloading or flanges on side may be damaged and/or door hinges may make hard contact with guides.
- When operating CHU with nonstandard, end-opening, 20-ft.-long shipping containers, operator needs to take extra care to make sure that sliders and guides contact container properly, container slides on sliders properly, and container loads centered on truck. Failure to comply may result in container getting hung up or making hard contact with sliders and guides, causing damage to CHU or container.

NOTE

- For detailed instructions on how to operate the LHS, refer to “LHS Controls and Indicators” (Para 2-1), “Picking Up a Flatrack in Auto Mode” (Para 2-9 b), and “Off-Loading Flatrack in Auto Mode” (Para 2-9 c).
- Rear mud flaps may be pinned up to provide better visibility of front lift adapter lower container locks.
- Multiple connected containers cannot be used with CHU. This includes Six CONS and Quad CONS.

Operating Instructions (Cont)

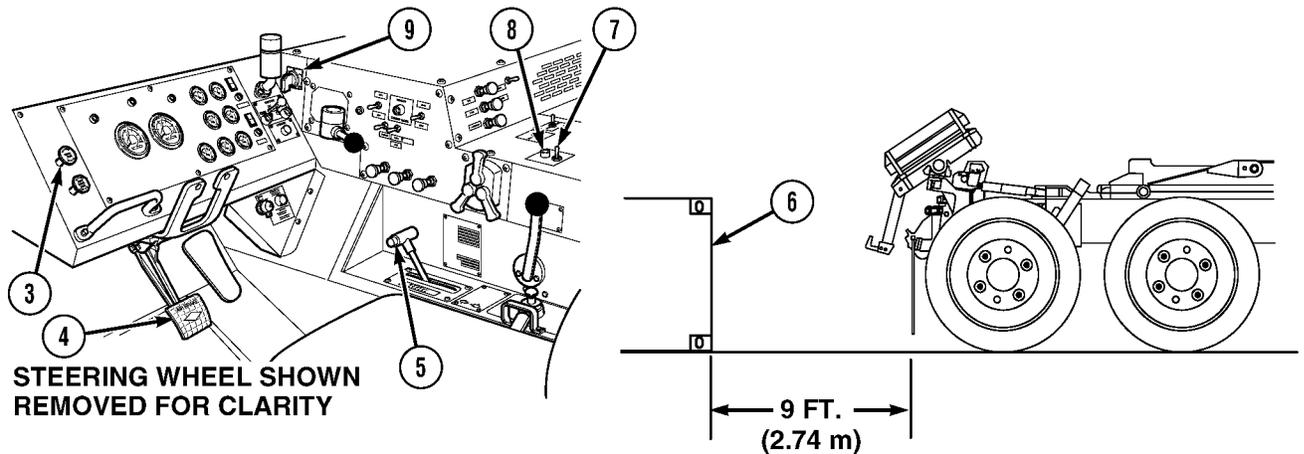

- (3) Start engine (TM 9-2320-279-10).
- (4) Push in parking brake knob (3), apply service brake pedal (4), and set transmission range selector (5) to R (Reverse).
- (5) Release service brake pedal (4) and position rear of truck within 9 ft. (2.74 m) of front of container (6), aligning centerline of truck within 2 in. (5 cm) of container centerline.
- (6) Apply service brake pedal (4) and set transmission range selector (5) to N (Neutral).
- (7) Put PTO ENGAGE switch (7) in ON position. Make sure indicator light (8) comes on.

CAUTION

Engine speed must be at idle before using hydraulic selector switch, or damage to equipment may result.

- (8) Turn hydraulic selector switch (9) to AUTO.

Operating Instructions (Cont)

2-10.4 LOADING AND UNLOADING CONTAINER (51 INCHES [130 CM] OR TALLER) TO TRUCK USING FRONT LIFT ADAPTER (FLA) (CONT).

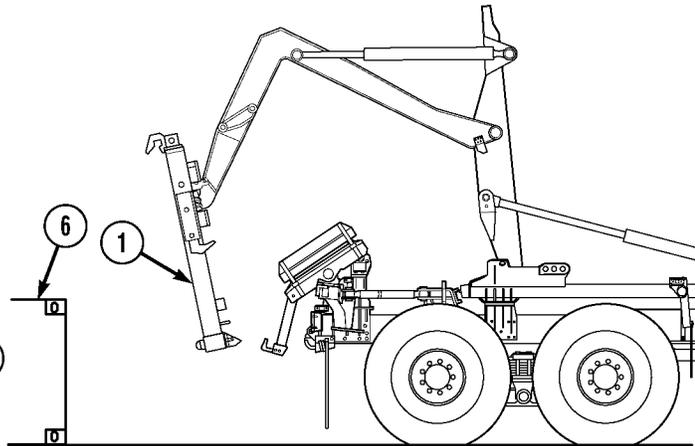
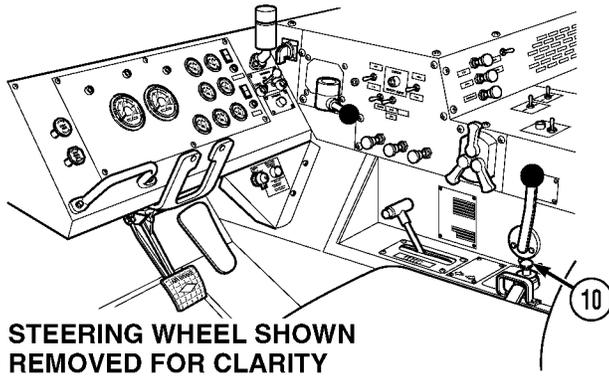

CAUTION

On steep downgrades, contact is possible between the front lift adapter lower legs and the rear sliders during empty LHS cycles. If contact appears likely, switch hydraulic selector to MAN H.A. position and retract (LOAD) hook arm a few inches. Return hydraulic selector to AUTO and continue (UNLOAD) operation. Repeat as required. Failure to comply may result in damage to equipment.

- (9) Move joystick (10) to UNLOAD position until front lift adapter (1) is positioned in front of container (6).

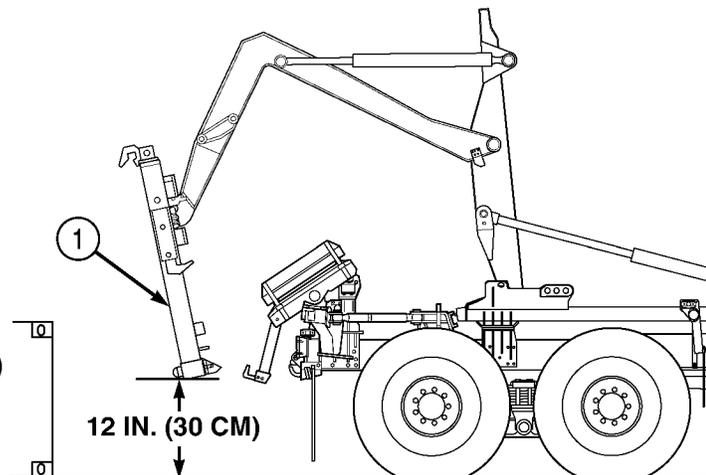
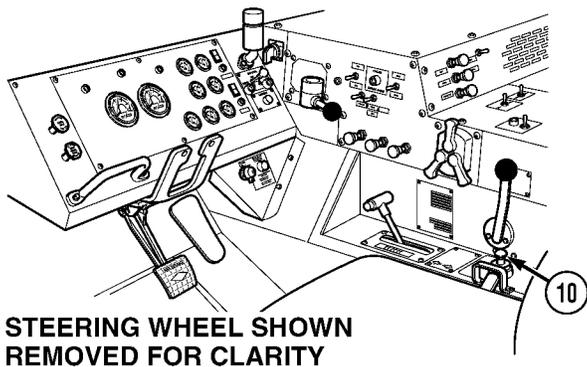

- (10) Operate LHS in AUTO mode until front lift adapter (1) is approximately 12 in. (30 cm) off of ground.
- (11) Release joystick (10).
- (12) Shut off engine (TM 9-2320-279-10).

Operating Instructions (Cont)

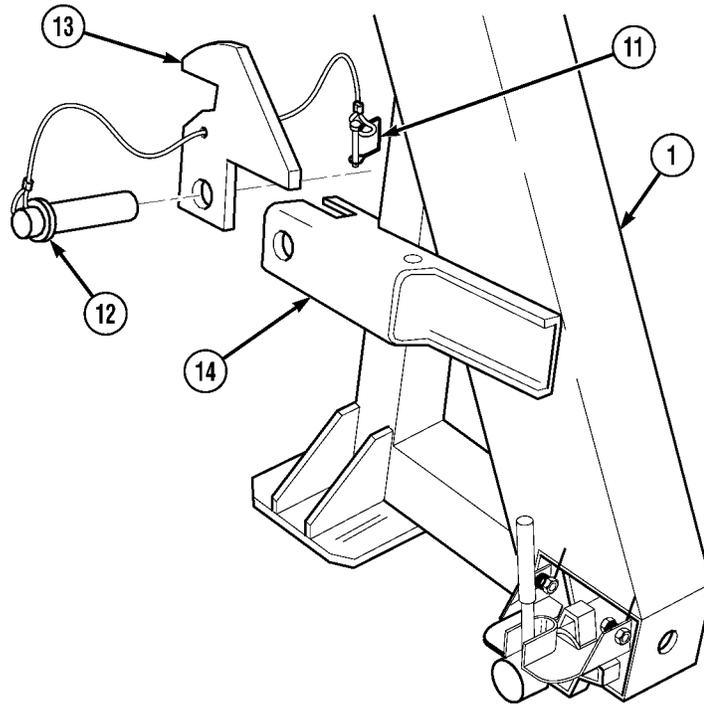
**NOTE**

- Refer to the front lift adapter data plate for the proper configuration needed for the height of container being loaded.
- There are two slide arms. Right side shown.

(13) Remove lock pin (11), pin (12), and half-height container front hook (13) from stowage bracket (14) on front lift adapter (1).

Operating Instructions (Cont)

2-10.4 LOADING AND UNLOADING CONTAINER (51 INCHES [130 CM] OR TALLER) TO TRUCK USING FRONT LIFT ADAPTER (FLA) (CONT).

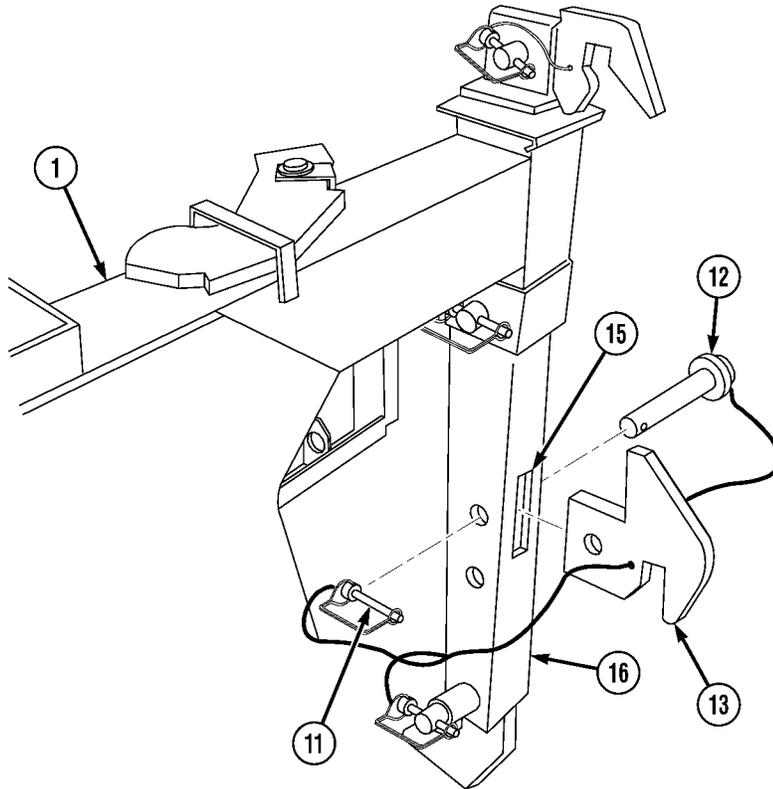

NOTE

Make sure half-height container front hooks face down when installed.

- (14) Position half-height container front hook (13) in slot (15) on slide arm (16) and install pin (12) and lock pin (11) on front lift adapter (1).

Operating Instructions (Cont)

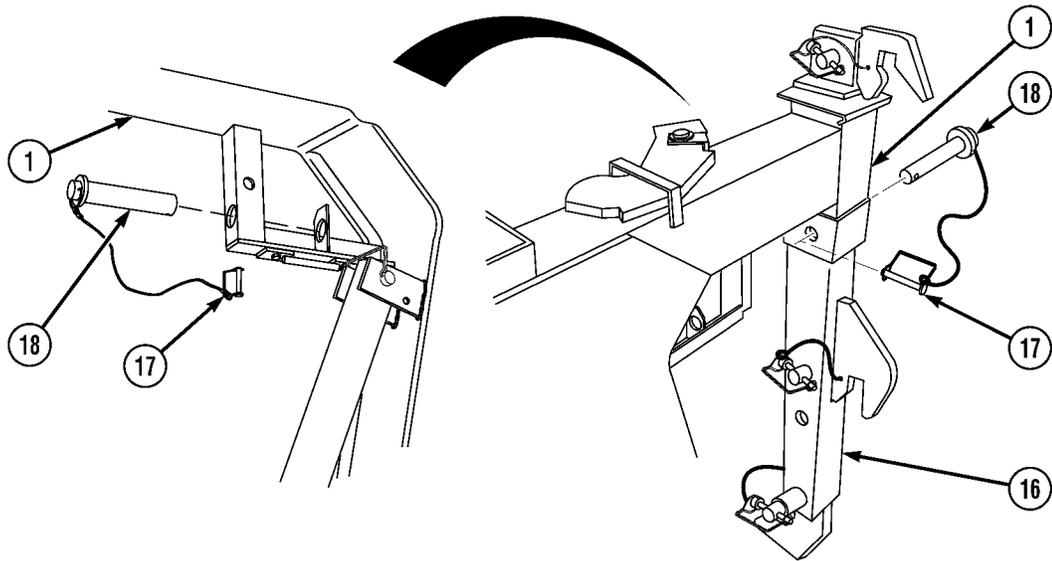

- (15) Remove lock pin (17) and pin (18) from front lift adapter (1) slide arm (16) upper hole.
- (16) Install pin (18) and lock pin (17) in stow position on front lift adapter (1).
- (17) Repeat steps (13) through (16) for left side.

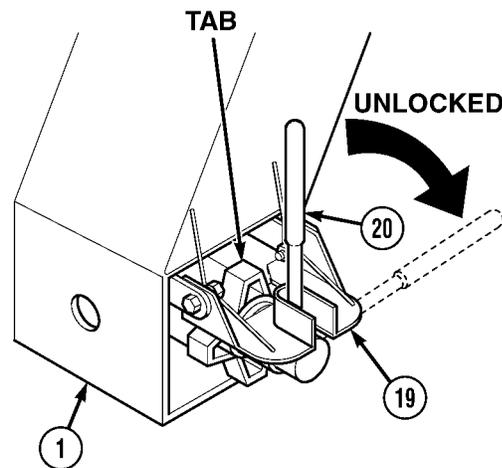

NOTE

- There are two front lift adapter lower container locks and rear sliders. Right side shown.
- Make sure front lift adapter lower container lock handle is positioned in slot on handle lock plate.
- Make sure tab on handnut faces up.

- (18) Raise handle lock plate (19) and rotate lower container lock handle (20) toward center of front lift adapter (1) to unlocked position.
- (19) Release handle lock plate (19) on front lift adapter (1).
- (20) Repeat steps (18) and (19) for left side.

Operating Instructions (Cont)

**2-10.4 LOADING AND UNLOADING CONTAINER (51 INCHES [130 CM] OR TALLER)
TO TRUCK USING FRONT LIFT ADAPTER (FLA) (CONT).**

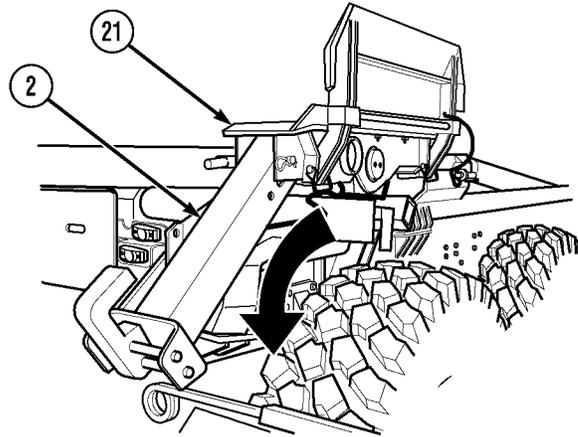

CAUTION

Make sure sliders are clear of debris and surfaces are properly greased or damage to equipment may result.

NOTE

There are two rear sliders and container locks. Right side shown.

- (21) Rotate slider (21) so rear of slider faces down.
- (22) Make sure rear container lock (2) is in ready mode or down position (Para 2-10.1).
- (23) Repeat steps (21) and (22) for left side.
- (24) Start engine (TM 9-2320-279-10).

Operating Instructions (Cont)

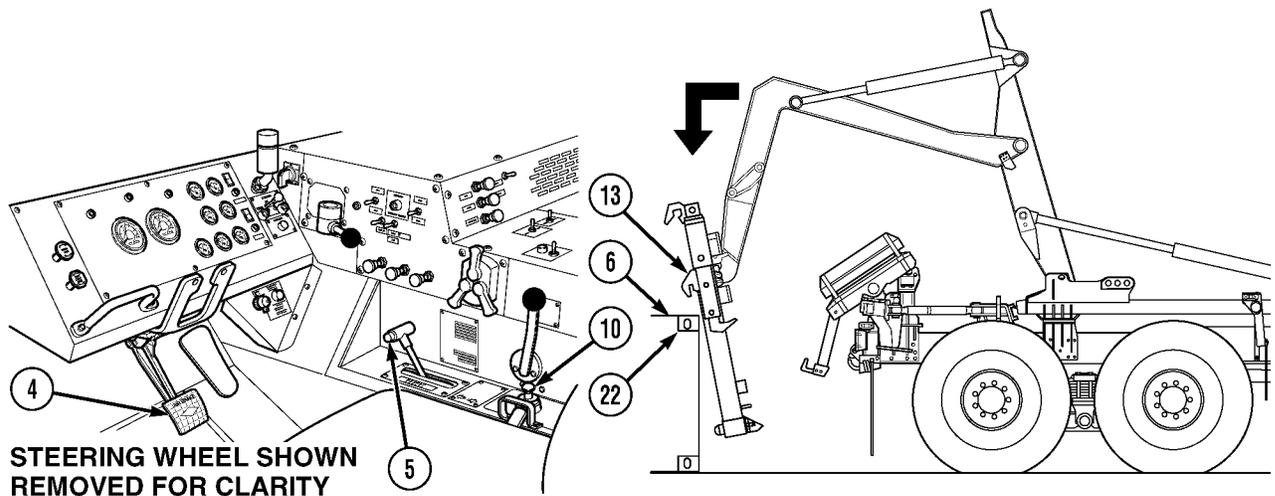

STEERING WHEEL SHOWN
REMOVED FOR CLARITY

- (25) Position half-height container front hooks (13) just above and in front of half-height container upper front corner castings (22).
- (26) Apply service brake pedal (4) and set transmission range selector (5) to R (Reverse).

WARNING

Do not allow front lift adapter to contact the ground when half-height container front hooks are not engaged with container upper corner castings. Failure to comply may result in damage to equipment and injury or death to personnel.

- (27) Release service brake pedal (4) and slowly back up to approximately 12 in. (30 cm) from front of container (6).

NOTE

LHS will only operate when transmission range selector is in N (Neutral).

- (28) Apply service brake pedal (4), set transmission range selector (5) to N (Neutral), move joystick (10) to LOAD, and raise front lift adapter until half-height container front hooks (13) are above container upper front corner castings (22).

CAUTION

Make sure half-height container front hooks are fully engaged with container upper corner castings. Failure to comply may result in damage to equipment.

NOTE

- To get half-height container front hooks to properly seat it may be necessary to drive truck forward slightly.
 - When container is on side slope, it may be difficult to get both upper hooks properly seated. Front lift adapter hangs level. To get front lift adapter to hang closer to same angle as container, it may be necessary to temporarily remove one rear container lock from slider and stow on downhill side of front lift adapter.
- (29) Release service brake pedal (4) and move joystick (10) to UNLOAD, lower half-height container front hooks (13) into half-height container upper front corner castings (22).
 - (30) Set transmission range selector (5) to R (Reverse), move truck backward approximately 12 in. (30 cm).

Operating Instructions (Cont)

2-10.4 LOADING AND UNLOADING CONTAINER (51 INCHES [130 CM] OR TALLER) TO TRUCK USING FRONT LIFT ADAPTER (FLA) (CONT).

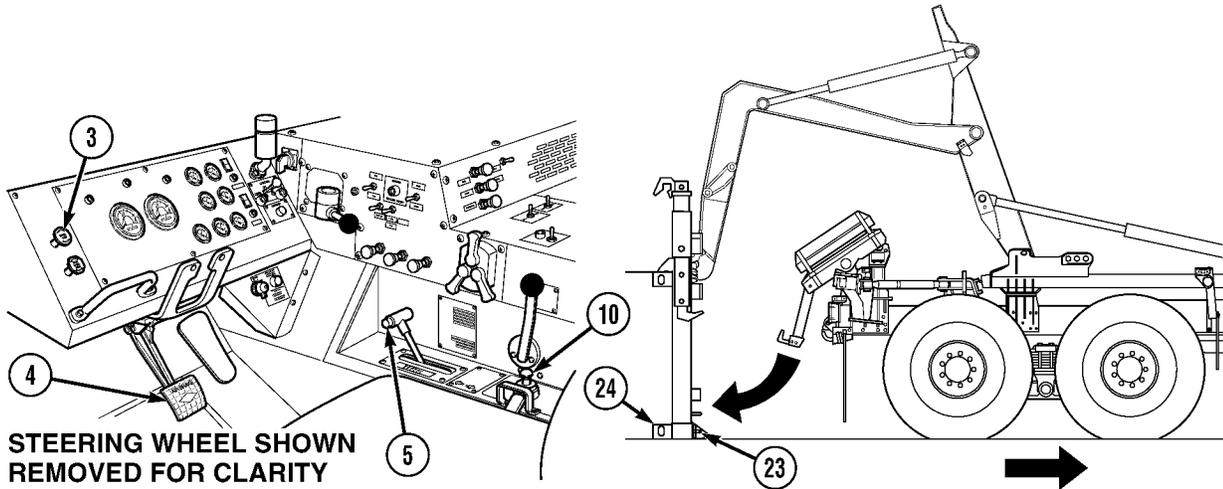

NOTE

LHS will only operate when transmission range selector is in N (Neutral).

- (31) Apply service brake pedal (4), set transmission range selector (5) to N (Neutral), and move joystick (10) to UNLOAD until lower container locks (23) are aligned with container lower front corner castings (24).
- (32) Apply service brake pedal (4) and set transmission range selector (5) to D (Drive).
- (33) Drive forward until lower container locks (23) are seated in container lower front corner castings (24). Apply service brake pedal (4) and release joystick (10).
- (34) Set transmission range selector (5) to N (Neutral) and pull out parking brake knob (3) to apply parking brakes.

Operating Instructions (Cont)

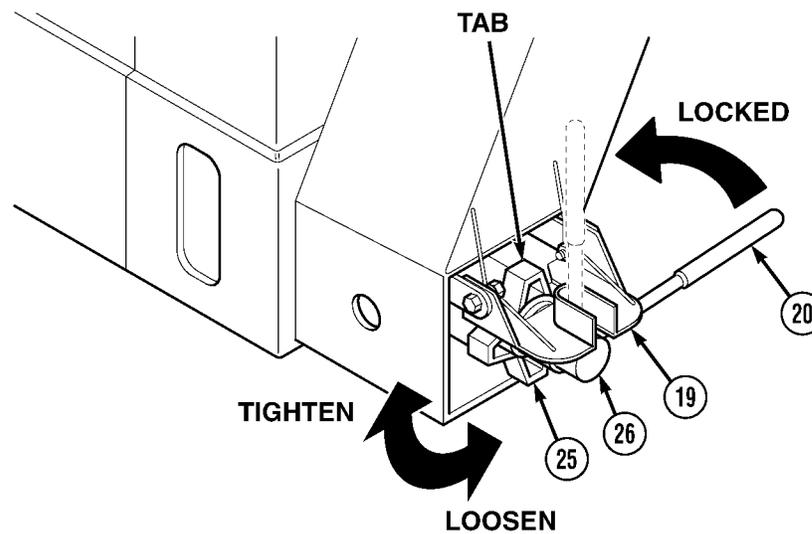
**CAUTION**

Make sure lower container locks are fully engaged with container lower front corner castings. Failure to comply may result in damage to equipment.

NOTE

- To get container lock handle to rotate, it may be necessary to loosen handnut.
- There are two lower container locks. Right side shown.
- After tightening handnut, it may be necessary to loosen handnut slightly to align tab with handle lock plate.
- Make sure lower container lock handle is secured in slot on handle lock plate.

- (35) Hold handle lock plate (19) and rotate lower container lock handle (20) up in the locked position.
 (36) Turn handnut (25) clockwise to tighten stem (26).

Operating Instructions (Cont)

2-10.4 LOADING AND UNLOADING CONTAINER (51 INCHES [130 CM] OR TALLER) TO TRUCK USING FRONT LIFT ADAPTER (FLA) (CONT).

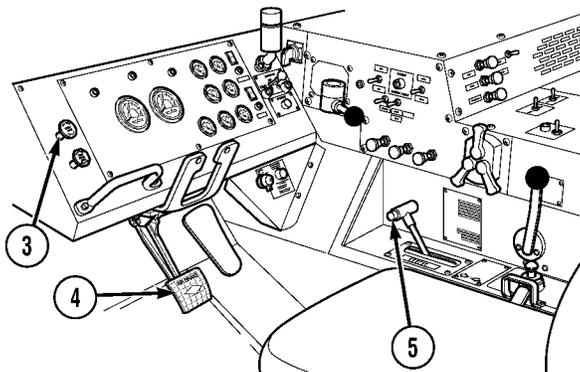

**STEERING WHEEL SHOWN
REMOVED FOR CLARITY**

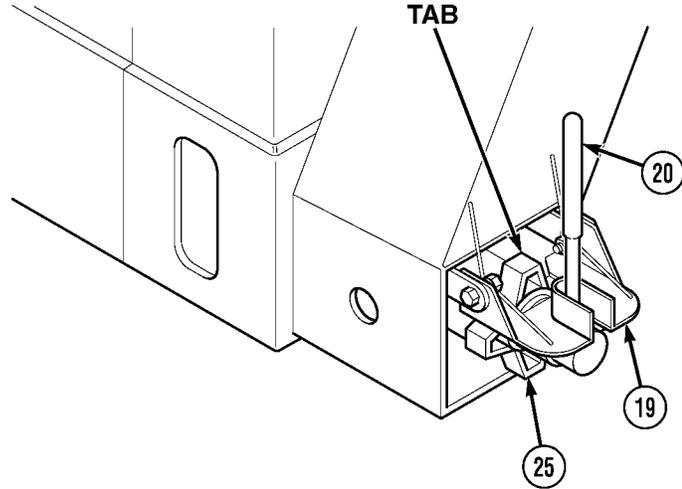

NOTE

Make sure tab on handnut faces up.

- (37) Lower handle lock plate (19) over lower container lock handle (20) and handnut (25) tab.
- (38) Repeat steps (35) through (37) for left side.
- (39) Set the transmission range selector (5) in N (Neutral), push in parking brake knob (3) to release parking brakes, and release service brake pedal (4).

Operating Instructions (Cont)**WARNING**

When loading or unloading containers on uneven ground (side slope up to 5 degrees and downgrades up to 20 percent), it may be necessary to apply truck service brakes to prevent truck rollaway or severe injury or death could result.

CAUTION

- If LHS OVER LOAD indicator illuminates but loading operation continues, operator is cautioned that LHS is nearing maximum capacity. In this situation, operator should notify supervisor if it appears payload is unevenly distributed in container or if container load exceeds 24,000 lbs. (10 886 kg). If any of these conditions exist, payload must be redistributed or reduced, or damage to equipment may result.
- Load must be evenly distributed in the container. Uneven load distribution may cause the LHS OVER LOAD indicator to give false signals and cause the LHS to operate incorrectly. Damage to equipment may result.
- If LHS OVER LOAD indicator illuminates and normal operation has stopped, return load to original position and notify supervisor to have payload redistributed or weight reduced. Failure to comply may result in damage to equipment.
- Make sure parking brake is not applied before starting load sequence, or damage to equipment may occur.

NOTE

- The amount of time to load and unload is controlled by engine speed. Engine speed can be increased to approximately 1500 rpm to reduce loading and unloading times.
- If container is extremely light or empty, it maybe necessary to place transmission range selector to R (Reverse) and allow truck to roll under container.
- If container is not centered, and transit locks cannot be installed and pinned, repeat steps (39) through (47) to reposition container.
- LHS will only operate when transmission range selector is in N (Neutral).

Operating Instructions (Cont)

2-10.4 LOADING AND UNLOADING CONTAINER (51 INCHES [130 CM] OR TALLER) TO TRUCK USING FRONT LIFT ADAPTER (FLA) (CONT).

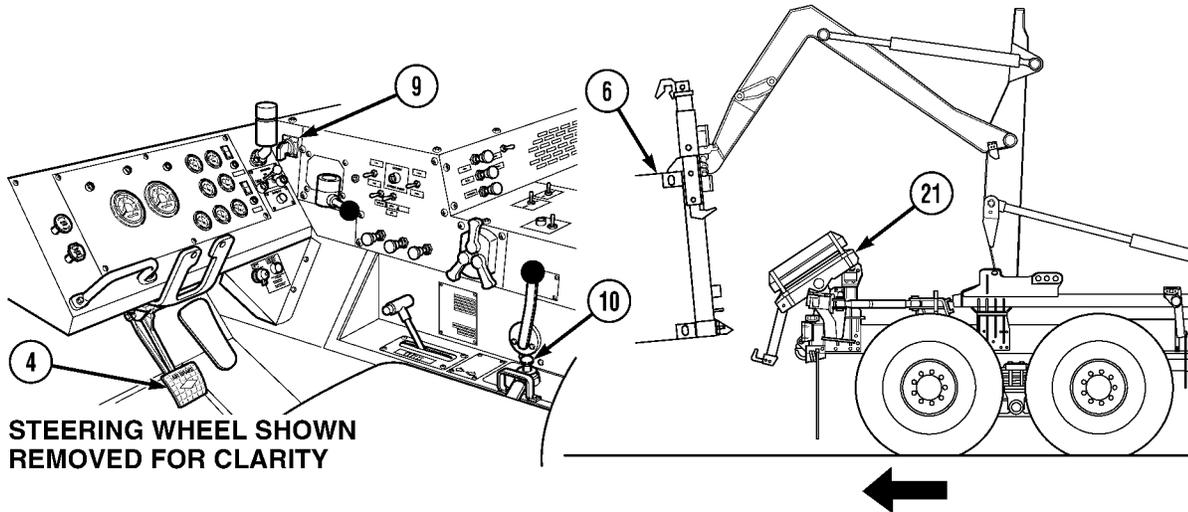

(40) Move joystick (10) to LOAD, allowing truck to be pulled under container (6).

WARNING

Make sure that container has contacted rear sliders correctly and is between guides. Failure to comply may result in serious injury or death to personnel and damage to equipment.

CAUTION

Reduce engine speed to idle before container contacts rear sliders, or damage to equipment may result.

NOTE

- LHS OVER LOAD indicator may illuminate when lifting container from unusual conditions.
- As load is lifted, truck will be pulled under container. Some steering wheel adjustment may have to be made to make sure that container contacts rear sliders correctly and is between guides.

(41) As container (6) contacts rear sliders (21), reduce engine speed to idle and apply service brake pedal (4).

NOTE

If container is being loaded in soft soil conditions, perform steps (42) through (44).

(42) Release joystick (10). Set hydraulic selector switch (9) to MAN H.A. position.

Operating Instructions (Cont)

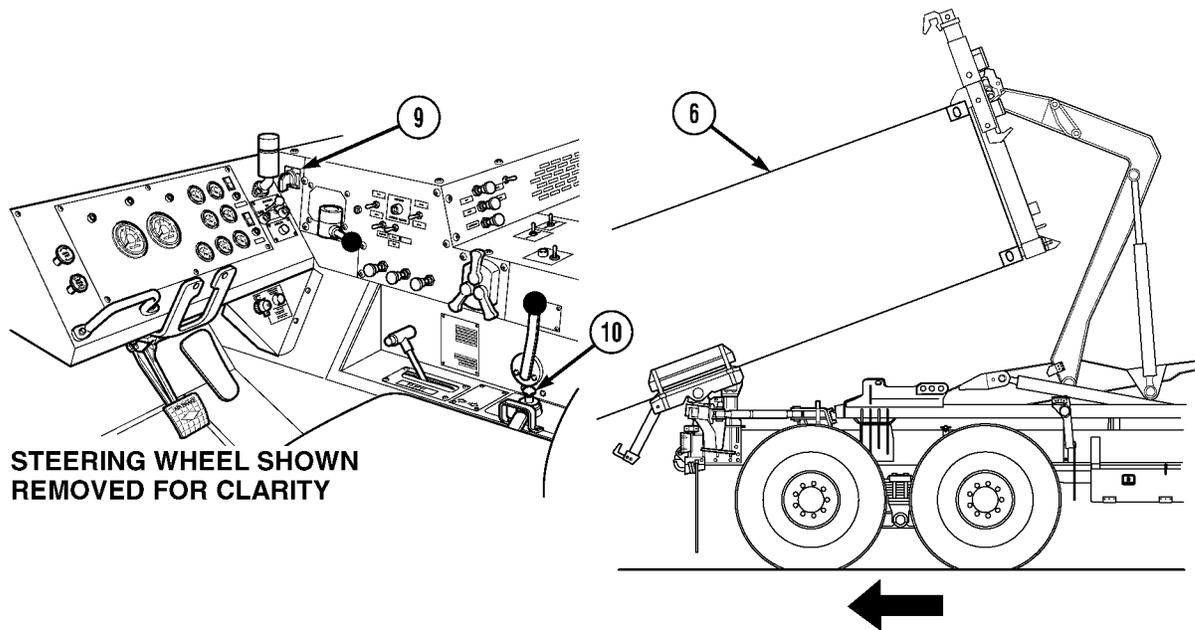

- (43) Move joystick (10) to LOAD until container (6) is approximately 2 ft. (61 cm) off the ground. Release joystick.
- (44) Set hydraulic selector switch (9) to AUTO. Resume normal AUTO operations.

Operating Instructions (Cont)

2-10.4 LOADING AND UNLOADING CONTAINER (51 INCHES [130 CM] OR TALLER) TO TRUCK USING FRONT LIFT ADAPTER (FLA) (CONT).

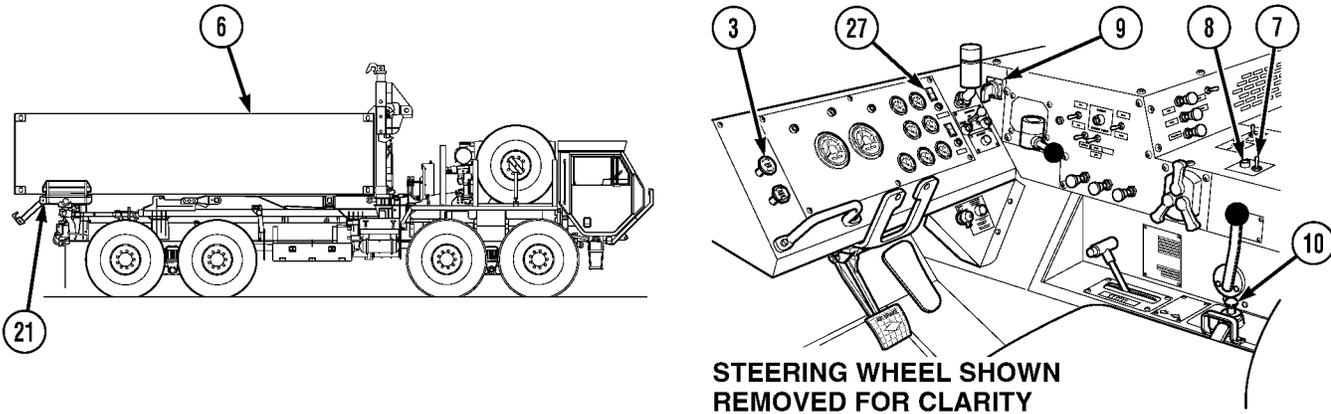

STEERING WHEEL SHOWN REMOVED FOR CLARITY

NOTE

Engine speed may be increased and decreased to ease loading.

- (45) After container (6) contacts rear sliders (21), increase engine speed to approximately 1500 rpm until container is almost loaded. Reduce engine speed to idle.
- (46) Continue loading until container (6) is fully loaded and LHS NO TRANS lamp (27) goes out.
- (47) Release joystick (10).
- (48) Pull out parking brake knob (3) to apply parking brake.

CAUTION

- Engine speed must be at idle before using hydraulic selector switch, or damage to equipment may result.
- Hydraulic selector switch must be in the OFF position before driving truck, or hydraulic system could overheat.

- (49) Turn hydraulic selector switch (9) to OFF.
- (50) Put PTO switch (7) in OFF position. Make sure indicator light (8) goes off.
- (51) Shut off engine (TM 9-2320-279-10).

Operating Instructions (Cont)

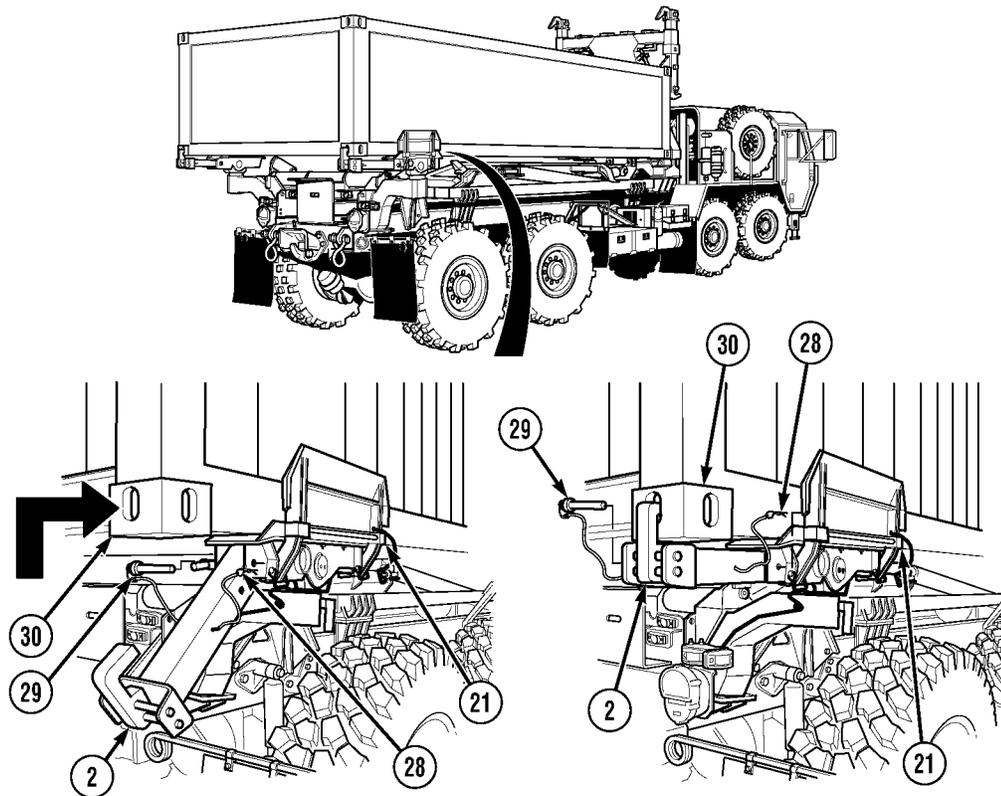
**NOTE**

- There are two rear container locks. Right side shown.
- If container is not centered and transit locks cannot be installed and pinned, repeat steps (40) through (51) to reposition container.

- (52) Support rear container lock (2) and remove lock pin (28) and pin (29).
 (53) Rotate rear container lock (2) up and position into container lower rear corner casting (30).
 (54) Install pin (29) and lock pin (28) in rear container lock (2) and slider (21).
 (55) Perform steps (39) through (48) for left side.

WARNING

- When loaded with a container, the center of gravity is moved up and toward rear of truck. Extreme caution must be taken when turning and ascending or descending on a grade. Failure to use extreme caution could result in severe injury or death to personnel.
- Maximum side slope when loaded with a container is 30 percent. Failure to comply may result in equipment damage or severe injury or death to personnel.
- Do not reduce tire pressure when loaded with FRS or container. Highway tire pressure, 60 psi (414 kPa) front and 83 psi (572 kPa) rear, is required at all times when loaded with FRS or container. Failure to comply could result in damage to equipment and severe injury or death to personnel.

Operating Instructions (Cont)

**2-10.4 LOADING AND UNLOADING CONTAINER (51 INCHES [130 CM] OR TALLER)
TO TRUCK USING FRONT LIFT ADAPTER (FLA) (CONT).**

b. Unloading.

WARNING

- Check for overhead power lines or other obstructions before attempting LHS operations. LHS reaches a height of 18 ft. (5.5 m). Injury or death could result if LHS contacts power lines.
- Do not attempt loading or unloading operations on a side slope greater than 5 degrees and/or fore/aft slope greater than 20 percent. Before attempting loading or unloading operations on slopes, determine if ground surface conditions permit safe loading or unloading operations. Slopes that contain snow, ice, loose gravel or sand may not permit safe loading or unloading.
- Check ground conditions for firmness and extreme sideways inclination before picking up or off-loading a container. Any ground instability beneath road wheels could cause serious injury or death to personnel.
- Prior to and during any load or unload cycle, all personnel should stay clear of LHS, front lift adapter, and container or serious injury or death may result.

CAUTION

- Check that ground conditions where container will be placed can support the container weight or damage to the container, front lift adapter or LHS may result.
- Use extreme caution when loading/unloading container with side doors. Container must remain centered during loading/unloading or flanges on side may be damaged and/or door hinges may make hard contact with guides.

NOTE

For detailed instructions on how to operate the LHS, refer to “LHS Controls and Indicators” (Para 2-1), “Picking Up a Flatrack in Auto Mode” (Para 2-9 b), and “Off-Loading Flatrack in Auto Mode” (Para 2-9 c).

- (1) Check area for operating room at front and rear of truck. Check overhead clearance and ground conditions.

Operating Instructions (Cont)

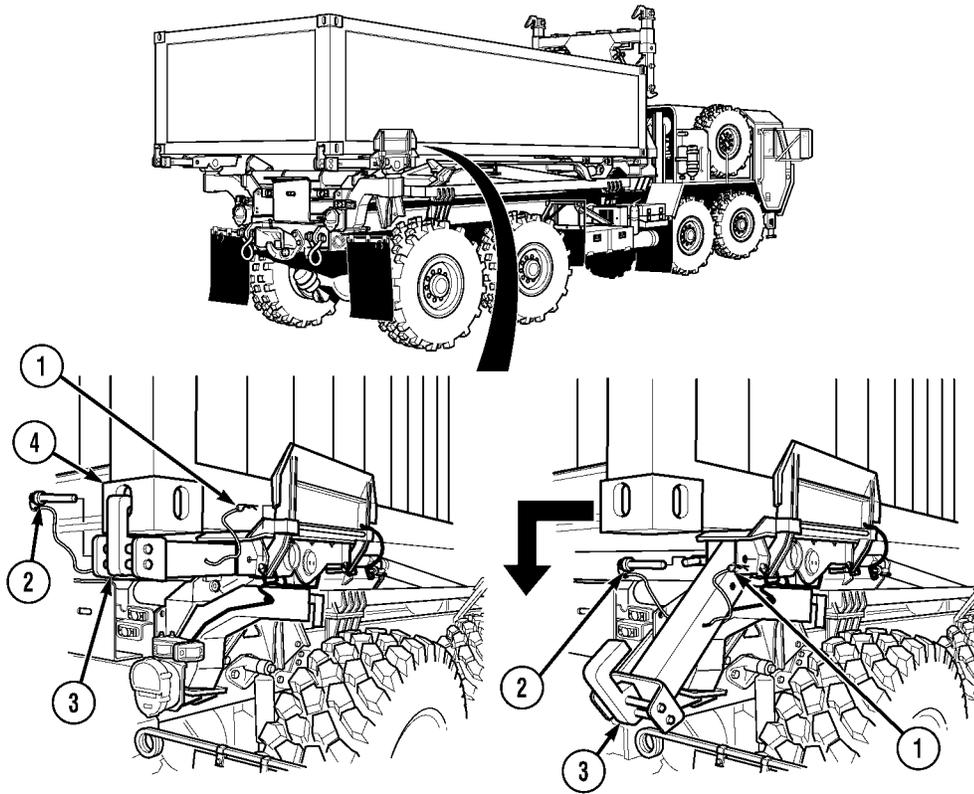

NOTE

There are two rear container locks. Right side shown.

- (2) Remove lock pin (1), pin (2), and rear container lock (3) from lower rear corner casting (4).
- (3) Rotate rear container lock (3) in down position and install pin (2) and lock pin (1).
- (4) Perform steps (2) and (3) for left side.

Operating Instructions (Cont)

2-10.4 LOADING AND UNLOADING CONTAINER (51 INCHES [130 CM] OR TALLER) TO TRUCK USING FRONT LIFT ADAPTER (FLA) (CONT).

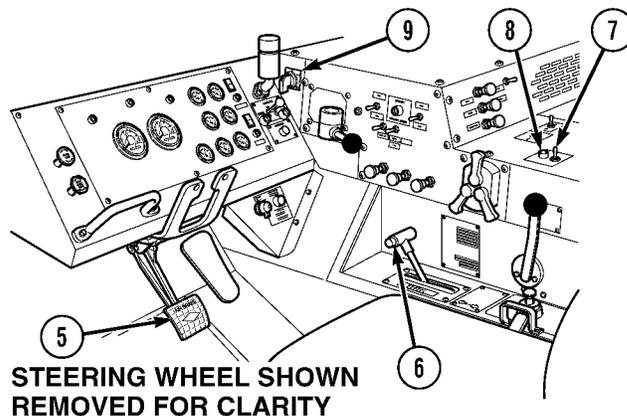

- (5) Start engine (TM 9-2320-279-10).
- (6) Apply service brake pedal (5) and set transmission range selector (6) to N (Neutral).
- (7) Put PTO ENGAGE switch (7) in ON position. Make sure indicator light (8) comes on.

CAUTION

Engine speed must be at idle before using hydraulic selector switch, or damage to equipment may result.

- (8) Turn hydraulic selector switch (9) to AUTO.

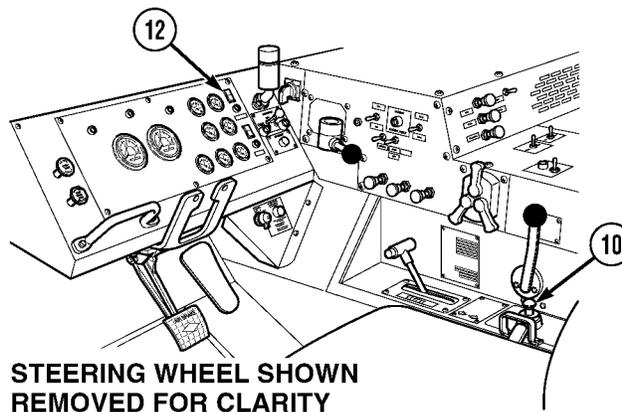
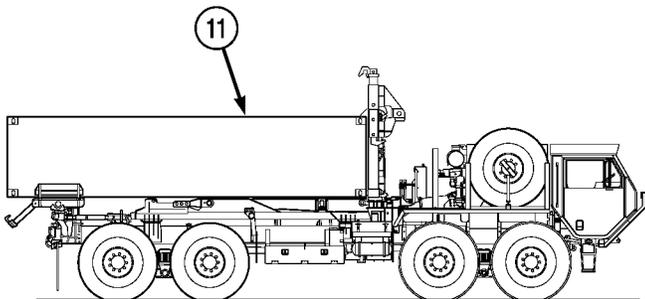

WARNING

When loading or unloading containers on uneven ground (side slope up to 5 degrees and downgrades up to 20 percent), it may be necessary to apply truck service brakes to prevent truck rollaway or severe injury or death could result.

NOTE

LHS will not operate and unload if rear container locks are engaged.

- (9) Move joystick (10) to UNLOAD. Container (11) will start to move rearward. LHS NO TRANS lamp (12) will illuminate. Maintain engine speed at idle until front of container raises approximately 12 in. (30 cm).

Operating Instructions (Cont)

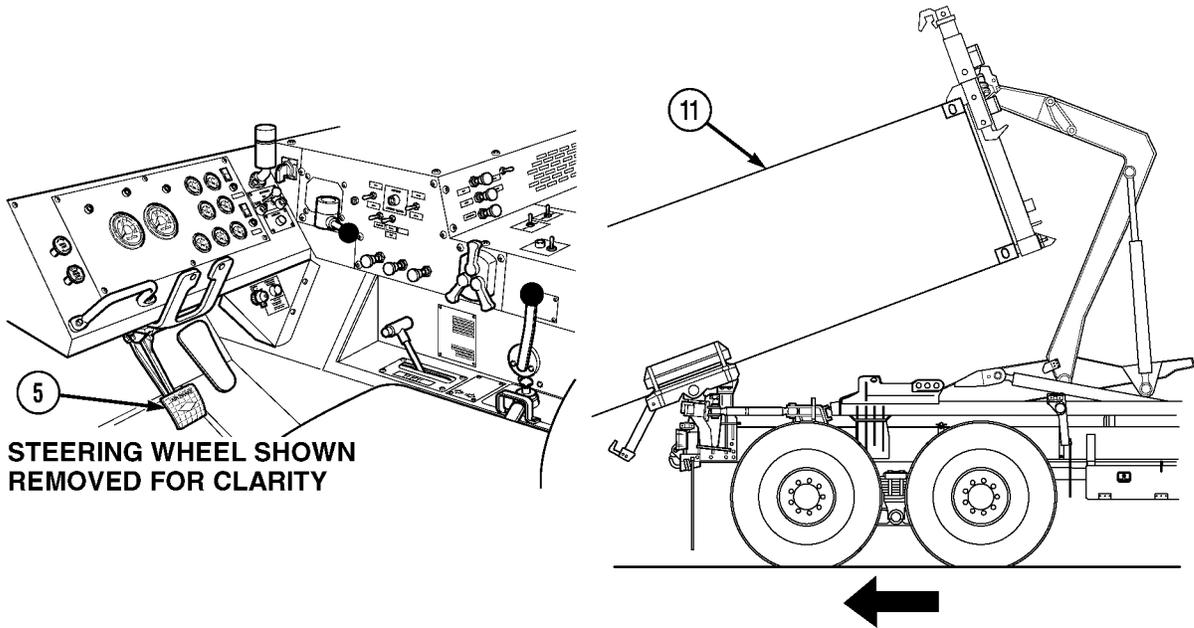

NOTE

The amount of time to load and unload is controlled by engine speed. Engine speed can be increased to approximately 1500 rpm to reduce loading and unloading times.

- (10) Continue to unload container (11) until back edge of container touches ground.
- (11) Release service brake pedal (5) and allow container (11) to push truck forward from under container.

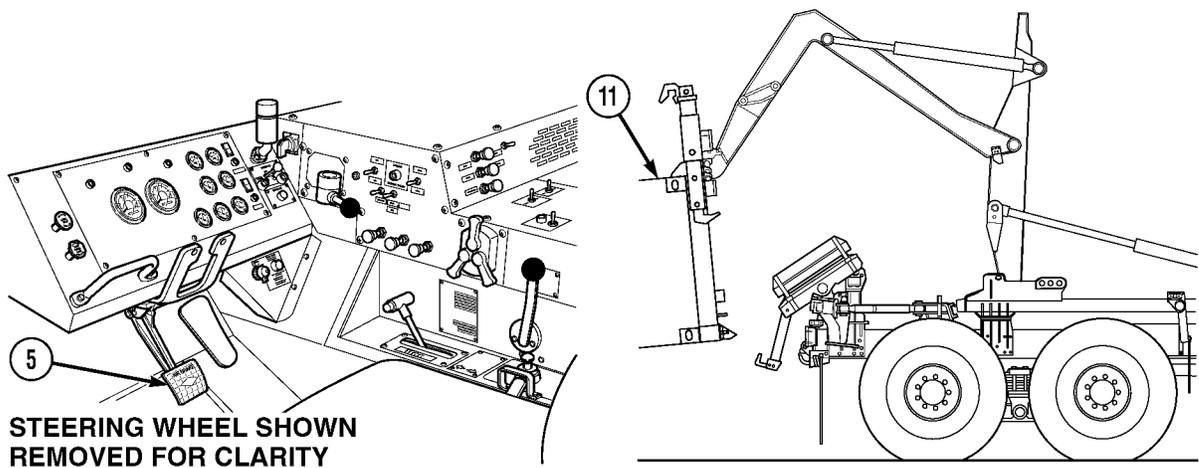

- (12) As front of container (11) approaches within approximately 8 in. (20.3 cm) of ground, decrease engine speed to idle and apply service brake pedal (5).

Operating Instructions (Cont)

2-10.4 LOADING AND UNLOADING CONTAINER (51 INCHES [130 CM] OR TALLER) TO TRUCK USING FRONT LIFT ADAPTER (FLA) (CONT).

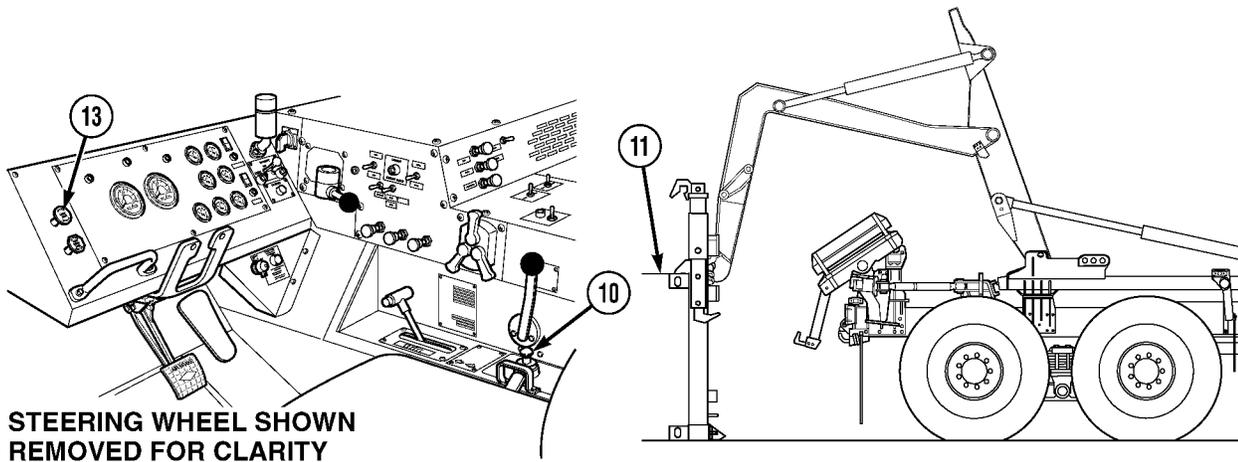

CAUTION

Once truck's rear suspension has been relieved of container load, do not continue in UNLOAD position as possibility of jacking up the rear of truck with hook arm may occur and damage to equipment may result.

NOTE

LHS will only operate when transmission range selector is in N (Neutral).

- (13) Continue unloading until bottom of container (11) is on ground and rear suspension is unloaded.
- (14) Release joystick (10) when container (11) is resting on ground.
- (15) Pull out parking brake knob (13) to apply parking brakes.

Operating Instructions (Cont)

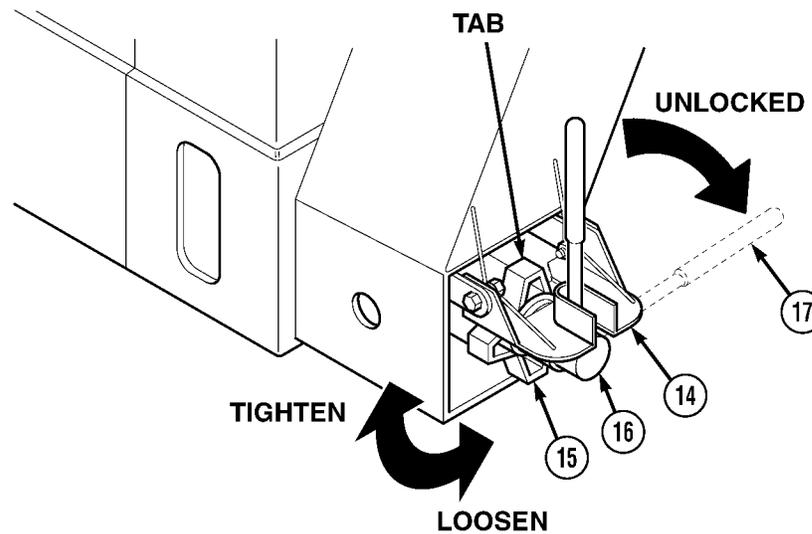
**WARNING**

Make sure that all tension has been relieved between LHS hook and front lift adapter prior to unlocking front lift adapter lower container locks. Stay clear of front lift adapter when unlocking front lift adapter lower container locks as front lift adapter may separate from container unexpectedly. Failure to comply may result in serious injury or death to personnel.

NOTE

There are two front lift adapter lower container locks. Right side shown.

- (16) Raise handle lock plate (14), turn handnut (15) counterclockwise to and loosen stem (16).

NOTE

Make sure tab on handnut faces up.

- (17) Rotate lower container lock handle (17) toward center of truck to unlocked position.
 (18) Turn handnut (15) clockwise to tighten stem (16).
 (19) Release handle lock plate (14) over container lock handle and handnut (15) tab.
 (20) Repeat steps (16) through (19) for left side.

Operating Instructions (Cont)

2-10.4 LOADING AND UNLOADING CONTAINER (51 INCHES [130 CM] OR TALLER) TO TRUCK USING FRONT LIFT ADAPTER (FLA) (CONT).

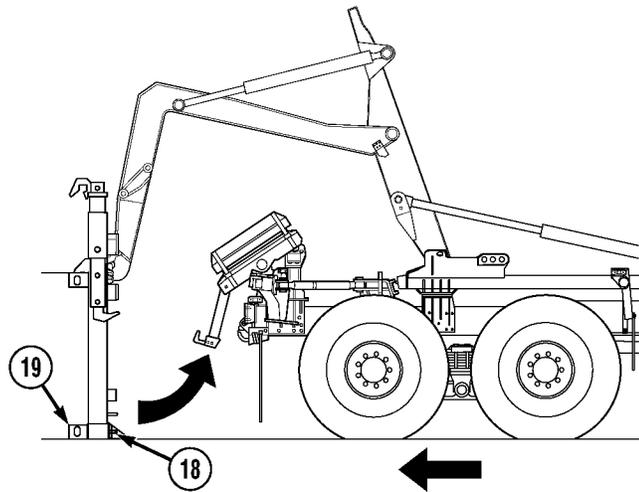
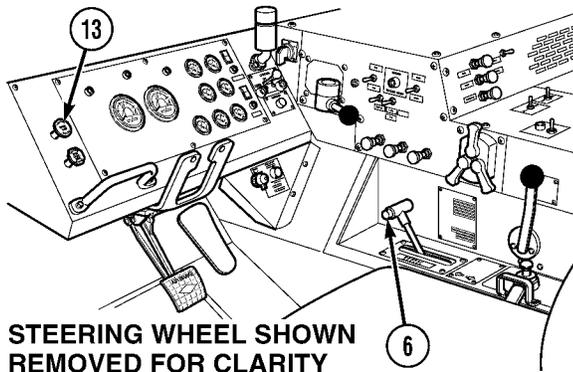

- (21) Push in parking brake knob (13) and release parking brakes. Set transmission range selector (6) to R (Reverse).
- (22) Move truck backward until lower container locks (18) disengage from lower front corner castings (19) approximately 4 to 6 in. (10 to 15 cm).

Operating Instructions (Cont)

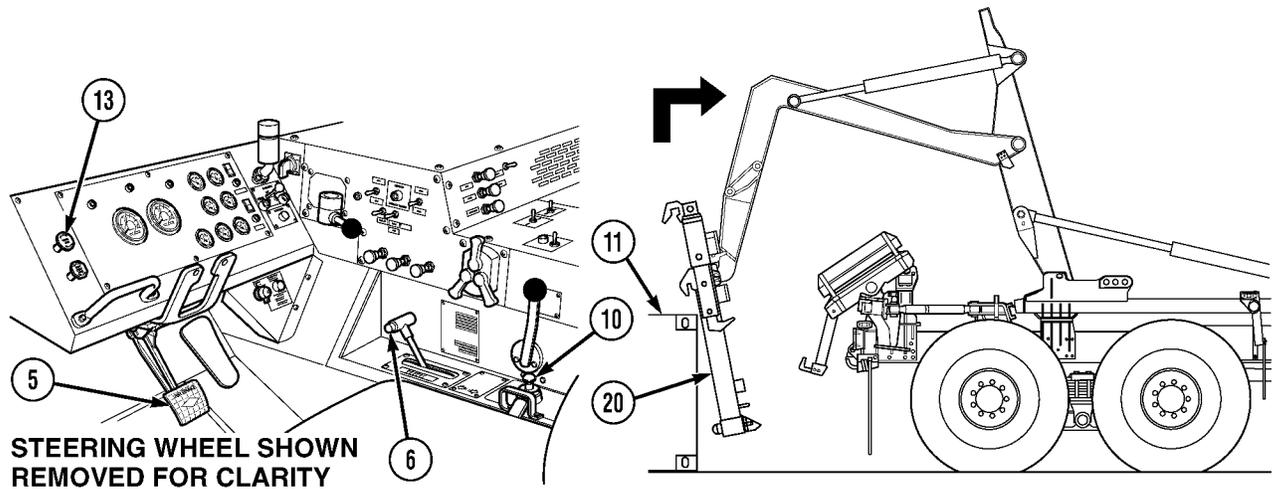
**CAUTION**

Make sure that the half-height container front hooks are completely disengaged and do not hang up in container upper corner castings when retracting LHS. Failure to comply may result in damage to the half-height container front hooks and/or container.

- (23) Apply service brake pedal (5) and set transmission range selector (6) to N (Neutral).

NOTE

- It may be necessary to move the truck forward or backward slightly to get the half-height container front hooks to disengage.
 - LHS will only operate when transmission range selector is in N (Neutral).
- (24) Move joystick (10) to LOAD position until front lift adapter (20) is disengaged from container (11).
- (25) Release joystick (10).
- (26) Move truck forward until rear of truck is approximately 9 ft. (2.74 m) in front of container.
- (27) Set transmission range selector (6) to N (Neutral) and pull out parking brake knob (13) to apply parking brakes.
- (28) Move joystick (10) to unload position until front lift adapter is positioned approximately 12 in. (30 cm) off the ground.

Operating Instructions (Cont)

2-10.4 LOADING AND UNLOADING CONTAINER (51 INCHES [130 CM] OR TALLER) TO TRUCK USING FRONT LIFT ADAPTER (FLA) (CONT).

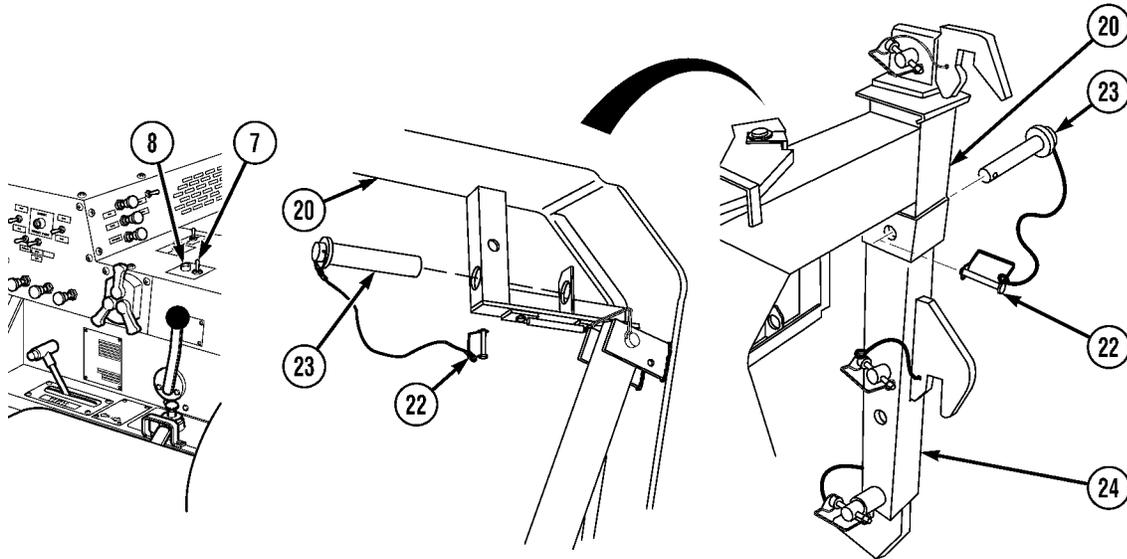

NOTE

- Perform steps (29) through (33) if CHU operations for 51-in. (130 cm) containers have been completed.
- There are two slide arms and half-height container front hooks. Right side shown.

(29) Remove lock pin (22) and pin (23) from stow position on front lift adapter (20).

(30) Install pin (23) and lock pin (22) in front lift adapter (20) and slide arm (24) upper hole.

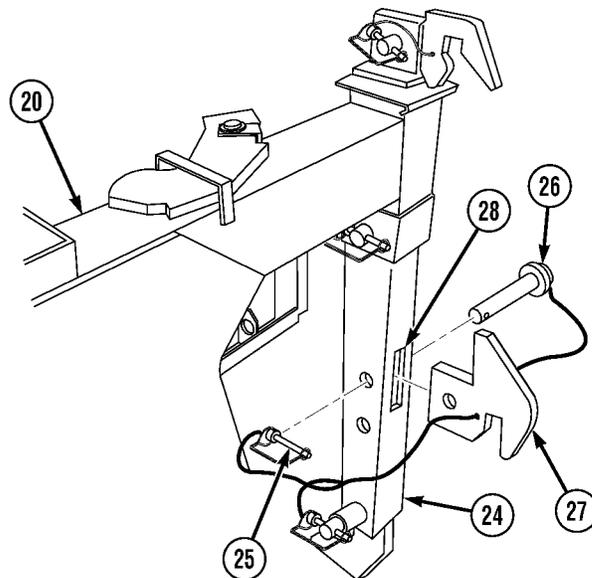

(31) Remove lock pin (25), pin (26), and half-height container front hook (27) from slot (28) in slide arm (24).

Operating Instructions (Cont)

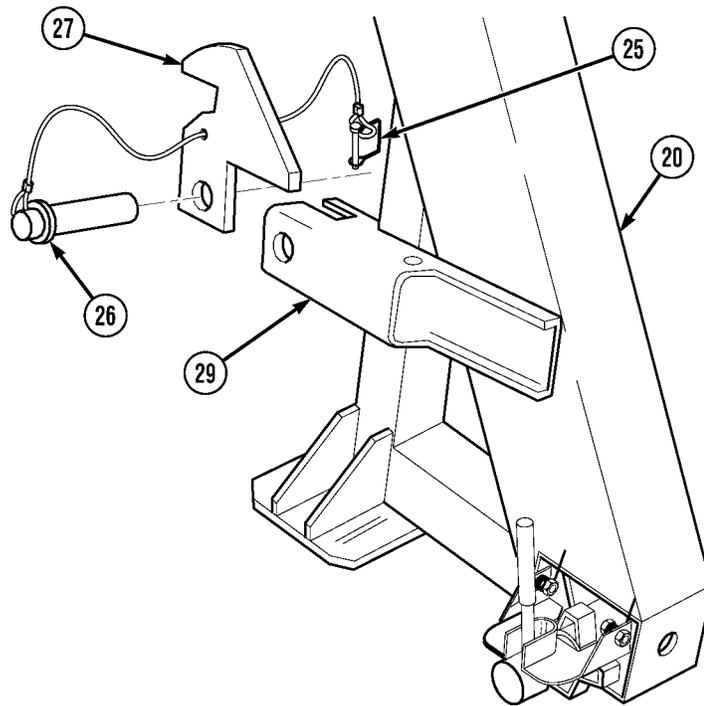

- (32) Position half-height container front hook (27) in stowage bracket (29) on front lift adapter (20) and install pin (26) and lock pin (25).
- (33) Repeat steps (29) through (32) for left side.

Operating Instructions (Cont)

2-10.4 LOADING AND UNLOADING CONTAINER (51 INCHES [130 CM] OR TALLER) TO TRUCK USING FRONT LIFT ADAPTER (FLA) (CONT).

CAUTION

- On steep downgrades, contact is possible between the front lift adapter lower legs and the rear sliders during empty LHS cycles. If contact appears likely, switch hydraulic selector to MAN H.A. position and retract (LOAD) hook arm a few inches. Switch hydraulic selector to MAN M.F. position and retract the main frame until the front lift adapter clears the rear sliders. Return hydraulic selector to AUTO and continue (LOAD) operation. Failure to comply may result in damage to equipment.
- Never drive with LHS NO TRANS lamp illuminated. An illuminated lamp means that the LHS is not fully stowed. Failure to comply may result in damage to equipment.

NOTE

The amount of time to load and unload is controlled by engine speed. Engine speed can be increased to approximately 1500 rpm to reduce loading and unloading times.

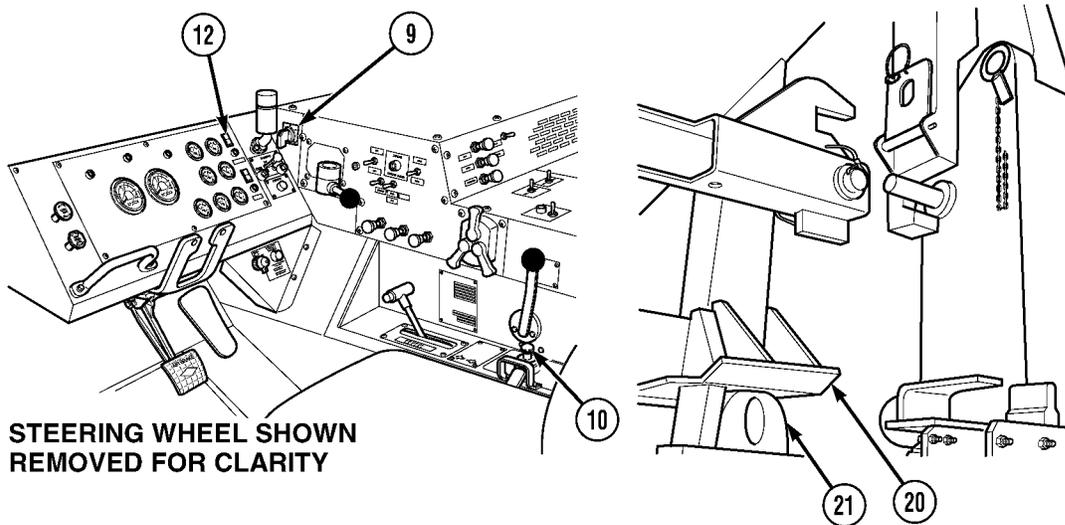

STEERING WHEEL SHOWN REMOVED FOR CLARITY

- (34) Move joystick (10) to LOAD position until LHS is fully retracted and front lift adapter (20) is positioned on bumper supports (21). LHS NO TRANS lamp (12) will go out, indicating LHS is in transport position.
- (35) Release joystick (10).

CAUTION

- Engine speed must be at idle before using hydraulic selector switch, or damage to equipment may result.
- Hydraulic selector switch must be in the OFF position before driving truck, or hydraulic system could overheat.

- (36) Turn hydraulic selector switch (9) to OFF.

Operating Instructions (Cont)

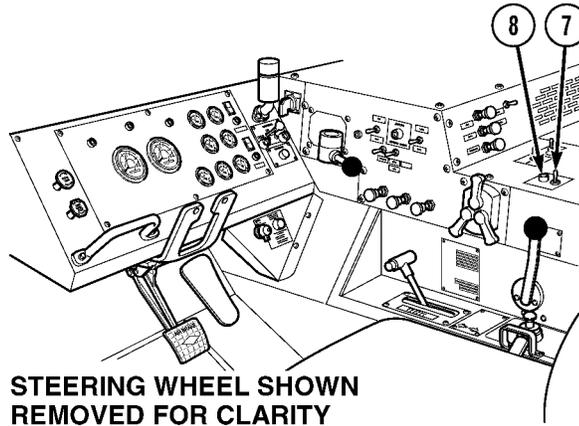

- (37) Put PTO ENGAGE switch (7) in OFF position. Make sure indicator light (8) goes off.

Operating Instructions (Cont)

2-10.5 LOADING AND UNLOADING CONTAINER (48 INCHES [122 CM] OR TALLER) TO TRUCK USING FRONT LIFT ADAPTER (FLA).

a. Loading.

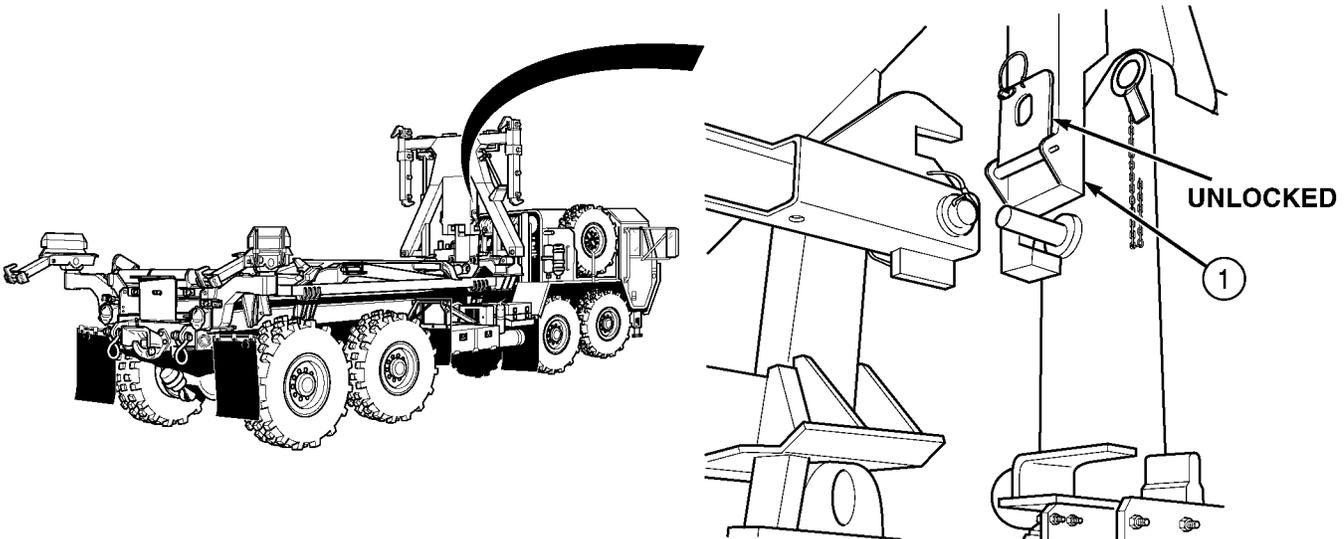

WARNING

Front lift adapter weighs 1,600 lbs. (726 kg). Personnel must stay clear when installing or removing front lift adapter to LHS hook arm hook. Failure to comply may result in injury or death to personnel.

CAUTION

Make sure front lift adapter is in the unlocked position before attempting to load a container to truck. Failure to comply will result in damage to equipment.

- (1) Make sure front lift adapter (1) is unlocked (Para 2-10.6).

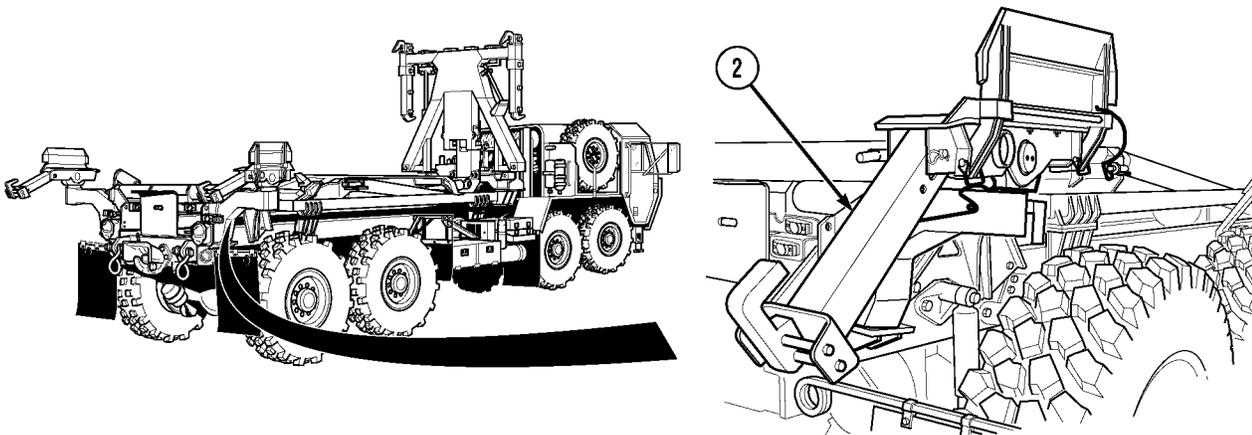

- (2) Make sure rear container lock (2) is in ready mode, refer to (Para 2-10.1).

Operating Instructions (Cont)

WARNING

- Check for overhead power lines or other obstructions before attempting LHS operations. LHS reaches a height of 18 ft. (5.5 m). Injury or death could result if LHS contacts power lines.
- Two personnel must be used (driver and spotter) to position front lift adapter (FLA). Failure to comply may result in damage to equipment and injury or death to personnel.
- Maximum permissible gross container weight is 24,000 lbs. (10 886 kg).
- Use caution when working around front lift adapter. Front lift adapter may swing unexpectedly when not attached to container. Failure to comply may result in injury or death to personnel.
- Do not stand between front lift adapter and container. Truck could roll, crushing personnel causing serious injury or death.
- Do not attempt loading or unloading operations on a side slope greater than 5 degrees and/or fore/aft slope greater than 20 percent. Before attempting loading or unloading operations on slopes, determine if ground surface conditions permit safe loading or unloading operations. Slopes that contain snow, ice, loose gravel or sand may not permit safe loading or unloading.

CAUTION

- Use extreme caution when loading/unloading container with side doors. Container must remain centered during loading/unloading or flanges on side may be damaged and/or door hinges may make hard contact with guides.
- When operating CHU with nonstandard, end-opening, 20-ft.-long shipping containers, operator needs to take extra care to make sure that sliders and guides contact container properly, container slides on sliders properly, and container loads centered on truck. Failure to comply can result in container getting hung up or making hard contact with sliders and guides, causing damage to CHU or container.

NOTE

- For detailed instructions on how to operate the LHS, refer to “LHS Controls and Indicators” (Para 2-1), “Picking Up a Flatrack in Auto Mode” (Para 2-9 b), and “Off-Loading Flatrack in Auto Mode” (Para 2-9 c).
- Rear mud flaps may be pinned up to provide better visibility of front lift adapter lower container locks.
- Multiple connected containers cannot be used with CHU. This includes Six CONS and Quad CONS.

Operating Instructions (Cont)

2-10.5 LOADING AND UNLOADING CONTAINER (48 INCHES [122 CM] OR TALLER) TO TRUCK USING FRONT LIFT ADAPTER (FLA) (CONT).

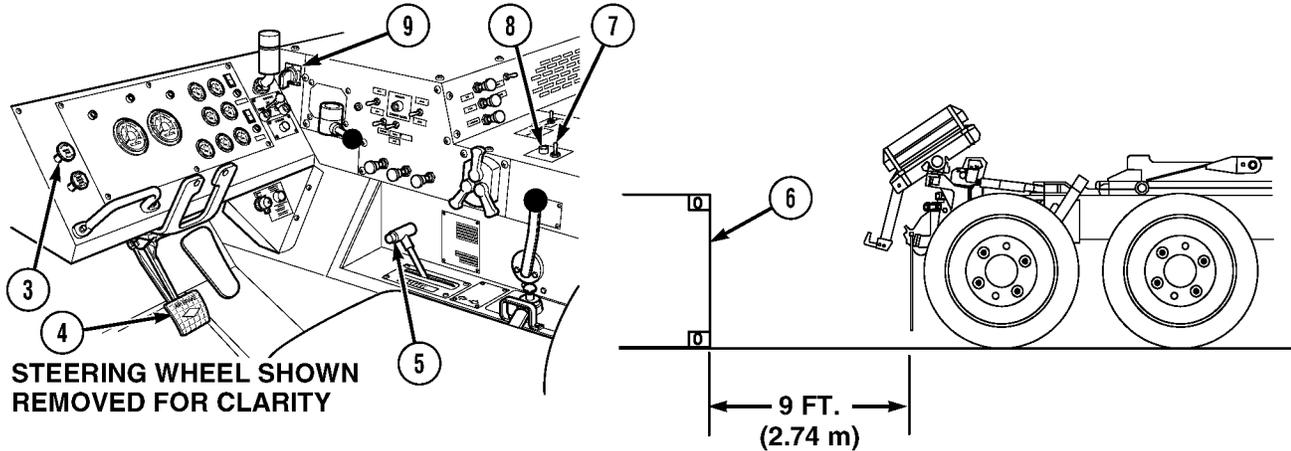

- (3) Start engine (TM 9-2320-279-10).
- (4) Push in parking brake knob (3), apply service brake pedal (4), and set transmission range selector (5) to R (Reverse).
- (5) Release service brake pedal (4) and position rear of truck within 9-ft. (2.74 m) of front of container (6), aligning centerline of truck within 2 in. (5 cm) of container centerline.
- (6) Apply service brake pedal (4) and set transmission range selector (5) to N (Neutral).
- (7) Put PTO ENGAGE switch (7) in ON position. Make sure indicator light (8) comes on.

CAUTION

Engine speed must be at idle before using hydraulic selector switch, or damage to equipment may result.

- (8) Turn hydraulic selector switch (9) to AUTO.

Operating Instructions (Cont)

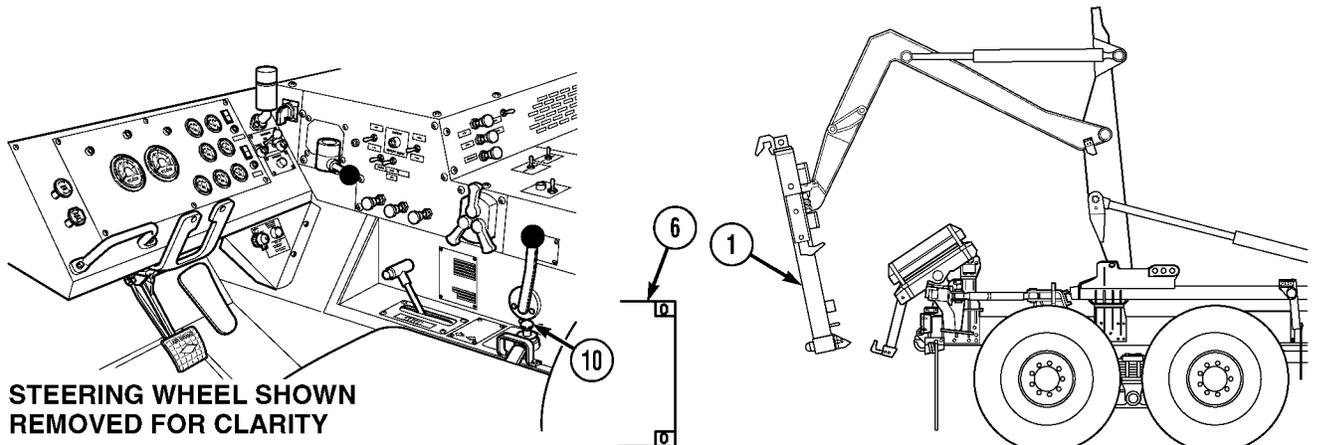
**CAUTION**

On steep downgrades, contact is possible between the front lift adapter lower legs and the rear sliders during empty LHS cycles. If contact appears likely, switch hydraulic selector to MAN H.A. position and retract (LOAD) hook arm a few inches. Return hydraulic selector to AUTO and continue (UNLOAD) operation. Repeat as required. Failure to comply may result in damage to equipment.

- (9) Move joystick (10) to UNLOAD position until front lift adapter (1) is positioned in front of container (6).
- (10) Operate LHS in AUTO mode until front lift adapter (1) is approximately 12 in. (30 cm) off ground.
- (11) Release joystick (10).

Operating Instructions (Cont)

**2-10.5 LOADING AND UNLOADING CONTAINER (48 INCHES [122 CM] OR TALLER)
TO TRUCK USING FRONT LIFT ADAPTER (FLA) (CONT).**

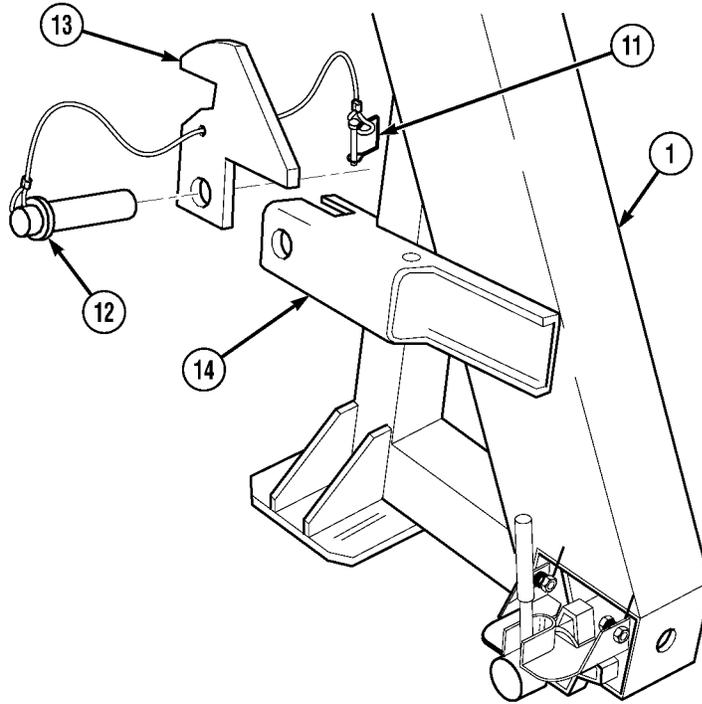

(12) Shut off engine (TM 9-2320-279-10).

NOTE

- Refer to the front lift adapter data plate for the proper configuration needed for the height of container being loaded.
- There are two slide arms. Right side shown.

(13) Remove lock pin (11), pin (12), and half-height container front hook (13) from stowage bracket (14) on front lift adapter (1).

Operating Instructions (Cont)

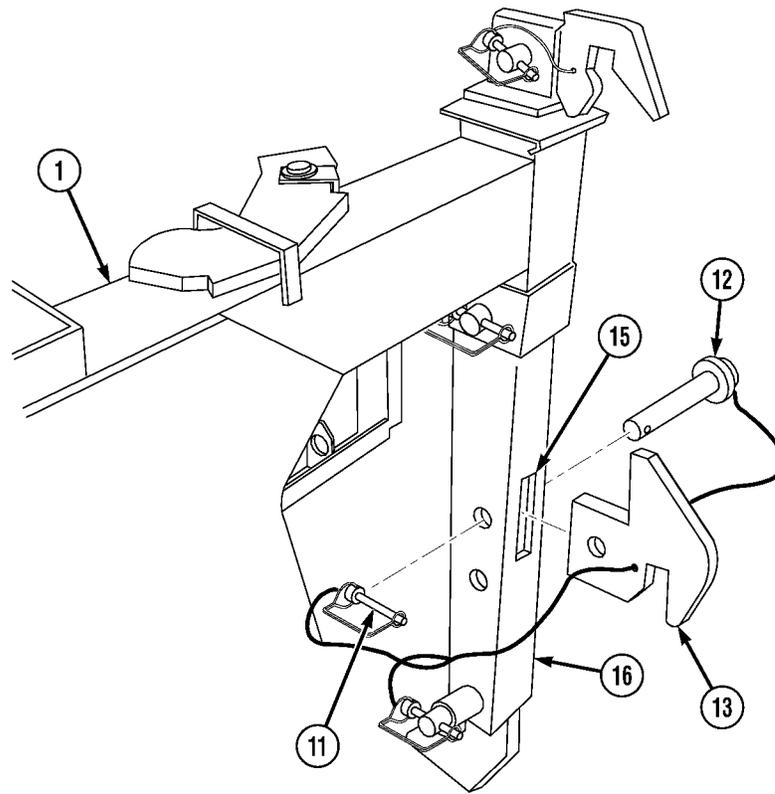
**NOTE**

Make sure half-height container front hooks face down when installed.

- (14) Position half-height container front hook (13) in slot (15) on slide arm (16) and install pin (12) and lock pin (11) on front lift adapter (1).

Operating Instructions (Cont)

2-10.5 LOADING AND UNLOADING CONTAINER (48 INCHES [122 CM] OR TALLER) TO TRUCK USING FRONT LIFT ADAPTER (FLA) (CONT).

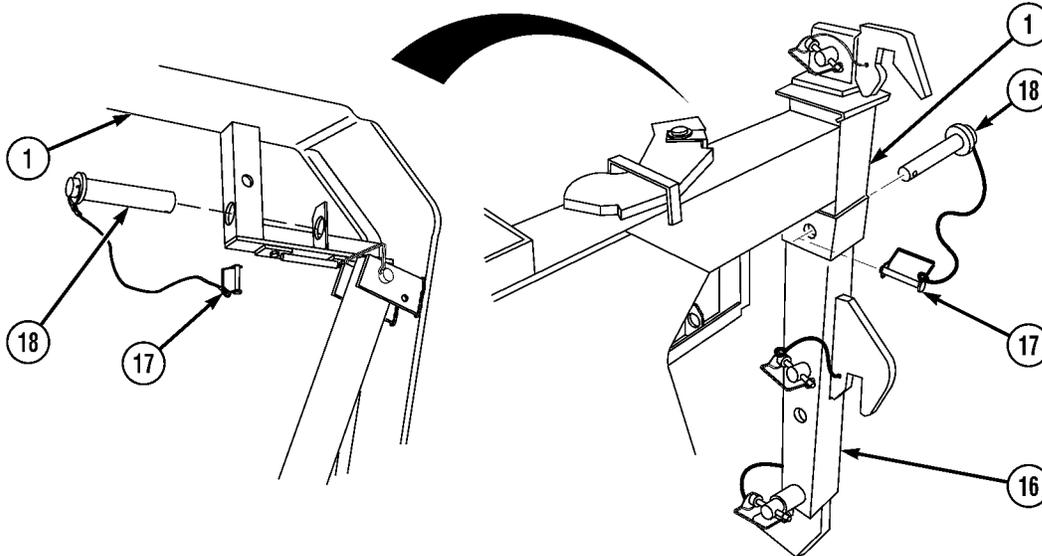

NOTE

If pin is in stow position, perform steps (15) and (16).

- (15) Remove lock pin (17) and pin (18) from stow position on front lift adapter (1).
- (16) Install pin (18) and lock pin (17) in front lift adapter (1) slide arm (16) in upper hole.
- (17) Repeat steps (13) through (16) for left side.

Operating Instructions (Cont)

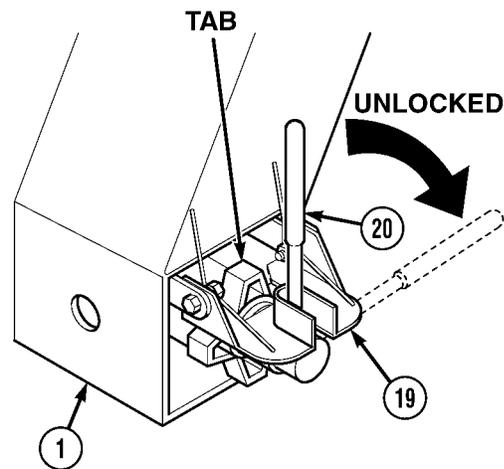
**NOTE**

- There are two front lift adapter lower container locks and rear sliders. Right side shown.
 - Make sure front lift adapter lower container lock handle is positioned in slot on handle lock plate.
 - Make sure tab on handnut faces up.
- (18) Raise handle lock plate (19) and rotate lower container lock handle (20) toward center of front lift adapter (1) to unlocked position.
- (19) Release handle lock plate (19) on front lift adapter (1).
- (20) Repeat steps (18) and (19) for left side.

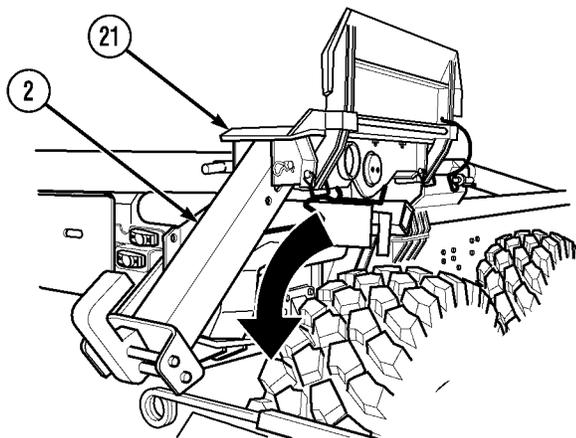
**CAUTION**

Make sure sliders are clear of debris and surfaces are properly greased or damage to equipment may result.

NOTE

There are two rear sliders and container locks. Right side shown.

- (21) Rotate slider (21) so rear of slider faces down.
- (22) Make sure rear container lock (2) is in ready mode or down position (Para 2-10.1).
- (23) Repeat steps (21) and (22) for left side.
- (24) Start engine (TM 9-2320-279-10).

Operating Instructions (Cont)

2-10.5 LOADING AND UNLOADING CONTAINER (48 INCHES [122 CM] OR TALLER) TO TRUCK USING FRONT LIFT ADAPTER (FLA) (CONT).

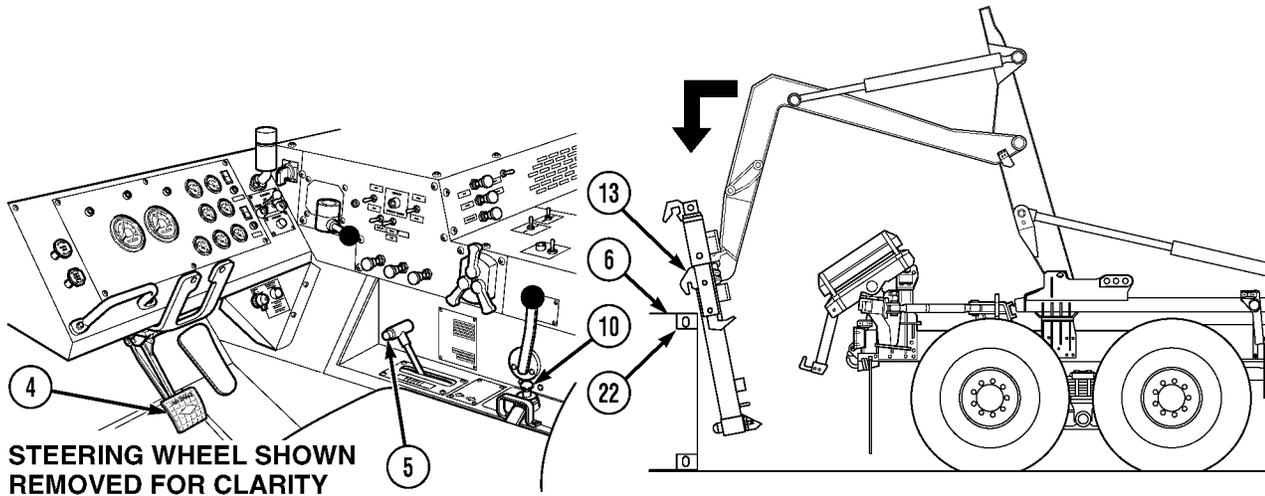

- (25) Position half-height container front hooks (13) just above and in front of half-height container upper front corner castings (22).

NOTE

LHS will only operate when transmission range selector is in N (Neutral).

- (26) Apply service brake pedal (4) and set transmission range selector (5) to R (Reverse).

WARNING

Do not allow front lift adapter to contact the ground when half-height container front hooks are not engaged with container upper corner castings. Failure to comply may result in damage to equipment and injury or death to personnel.

- (27) Release service brake pedal (4) and slowly back up to approximately 12 in. (30 cm) from front of container (6).
- (28) Apply service brake pedal (4), set transmission range selector (5) to N (Neutral), move joystick (10) to LOAD, and raise front lift adapter until half-height container front hooks (13) are above container upper front corner castings (22).

CAUTION

Make sure half-height container front hooks are fully engaged with container upper front corner castings. Failure to comply may result in damage to equipment.

NOTE

To get half-height container front hooks to properly seat, it may be necessary to drive truck forward slightly.

- (29) Release service brake pedal (4) and, moving joystick (10) to UNLOAD, lower half-height container front hooks (13) into half-height container upper front corner castings (22).
- (30) Set transmission range selector (5) to R (Reverse), move truck backward approximately 12 in. (30 cm).

Operating Instructions (Cont)

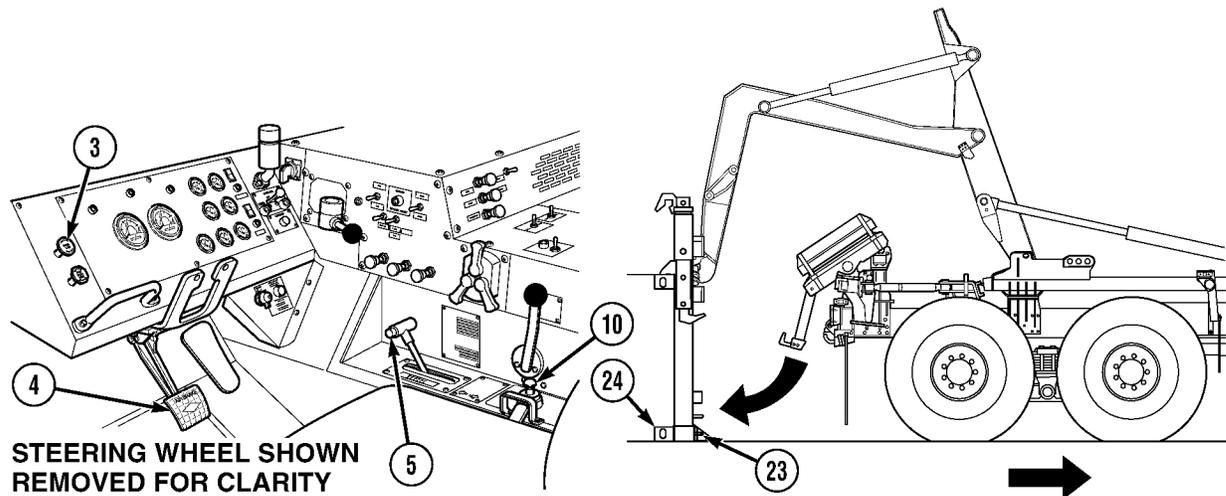
**NOTE**

LHS will only operate when transmission range selector is in N (Neutral).

- (31) Move joystick (10) to UNLOAD until lower container locks (23) are alined with container lower front corner castings (24).
- (32) Apply service brake pedal (4) and set transmission range selector (5) to D (Drive).
- (33) Drive forward until lower container locks (23) are seated in container lower front corner castings (24). Apply service brake pedal (4) and release joystick (10).
- (34) Set transmission range selector (5) to N (Neutral) and pull out parking brake knob (3) to apply parking brakes.

Operating Instructions (Cont)

2-10.5 LOADING AND UNLOADING CONTAINER (48 INCHES [122 CM] OR TALLER) TO TRUCK USING FRONT LIFT ADAPTER (FLA) (CONT).

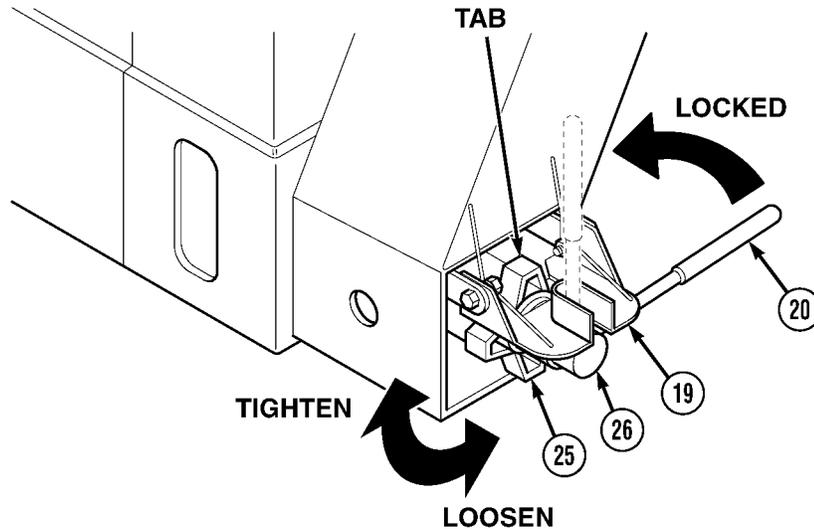

CAUTION

Make sure lower container locks are fully engaged with container lower front corner castings. Failure to comply may result in damage to equipment.

NOTE

- To get container lock handle to rotate, it may be necessary to loosen handnut.
- There are two lower container locks. Right side shown.
- After tightening handnut, it may be necessary to loosen handnut slightly to align tab with handle lock plate.
- Make sure lower container lock handle is secured in slot on handle lock plate.

(35) Hold handle lock plate (19) and rotate lower container lock handle (20) up in the locked position.

(36) Turn handnut (25) clockwise and tighten stem (26).

Operating Instructions (Cont)

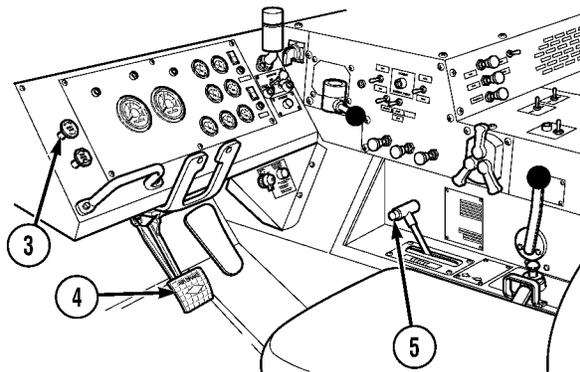

STEERING WHEEL SHOWN
REMOVED FOR CLARITY

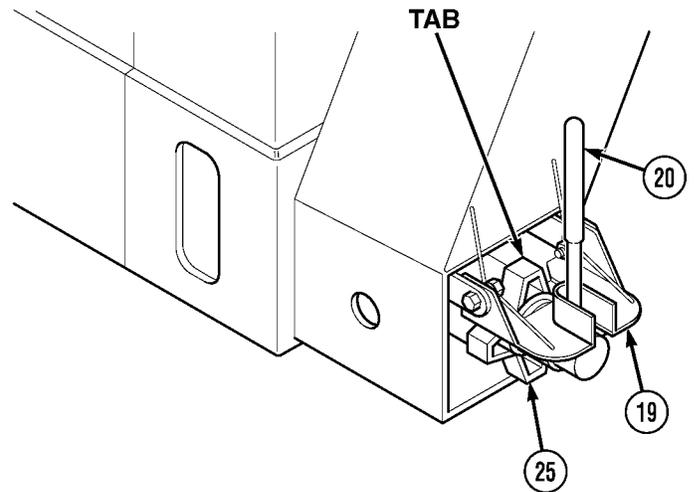

NOTE

Make sure tab on handnut faces up.

- (37) Lower handle lock plate (19) over lower container lock handle (20) and handnut (25) tab.
- (38) Repeat steps (35) through (37) for left side.
- (39) Push in parking brake knob (3) to release parking brakes and release service brake pedal (4).

Operating Instructions (Cont)

**2-10.5 LOADING AND UNLOADING CONTAINER (48 INCHES [122 CM] OR TALLER)
TO TRUCK USING FRONT LIFT ADAPTER (FLA) (CONT).**

WARNING

When loading or unloading containers on uneven ground (side slope up to 5 degrees and downgrades up to 20 percent), it may be necessary to apply truck service brakes to prevent truck rollaway or severe injury or death could result.

CAUTION

- If LHS OVER LOAD indicator illuminates but loading operation continues, operator is cautioned that LHS is nearing maximum capacity. In this situation, operator should notify supervisor if it appears payload is unevenly distributed in container or if container load exceeds 24,000 lbs. (10 886 kg). If any of these conditions exist, payload must be redistributed or reduced, or damage to equipment may result.
- Load must be evenly distributed in the container. Uneven load distribution may cause the LHS OVER LOAD indicator to give false signals and cause the LHS to operate incorrectly. Damage to equipment may result.
- If LHS OVER LOAD indicator illuminates and normal operation has stopped, return load to original position and notify supervisor to have payload redistributed or weight reduced. Failure to comply may result in damage to equipment.
- Make sure parking brake is not applied before starting load sequence, or damage to equipment may occur.

NOTE

- The amount of time to load and unload is controlled by engine speed. Engine speed can be increased to approximately 1500 rpm to reduce loading and unloading times.
- If container is extremely light or empty, it may be necessary to place transmission range selector to R (Reverse) and allow truck to roll under container.
- If container is not centered, and transit locks cannot be installed and pinned, repeat steps (39) through (48) to reposition container.
- LHS will only operate when transmission range selector is in N (Neutral).

Operating Instructions (Cont)

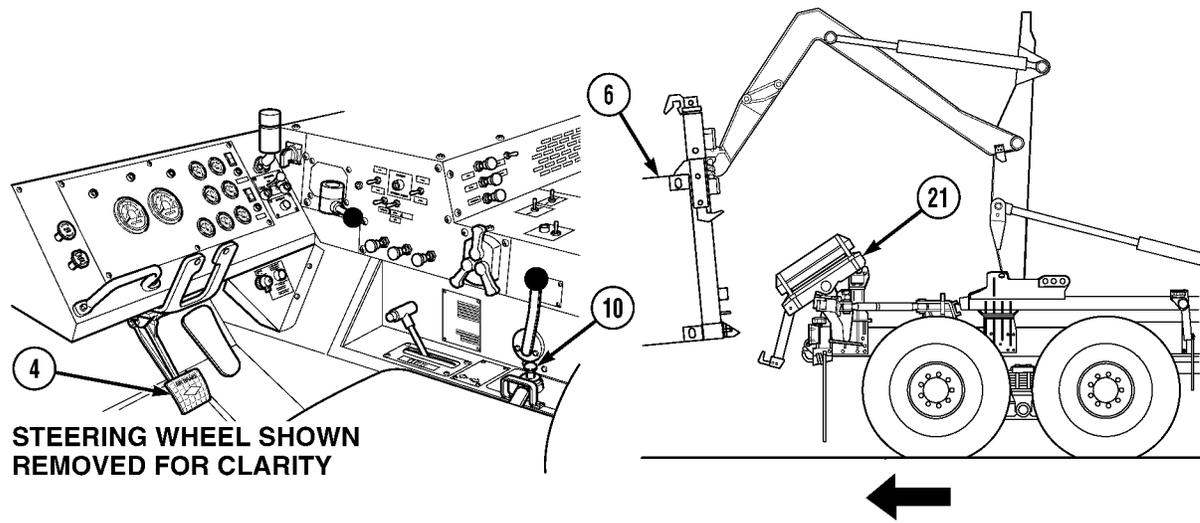

- (40) Move joystick (10) to LOAD, allowing truck to be pulled under container (6).

WARNING

Make sure that container has contacted rear sliders correctly and is between guides. Failure to comply may result in serious injury or death to personnel and damage to equipment.

CAUTION

Reduce engine speed to idle before container contacts rear sliders, or damage to equipment may result.

NOTE

- LHS OVER LOAD indicator may illuminate when lifting container from unusual conditions.
- As load is lifted, truck will be pulled under container. Some steering wheel adjustment may have to be made to make sure that container contacts rear sliders correctly and is between guides.

- (41) As container (6) contacts rear sliders (21), reduce engine speed to idle and apply service brake pedal (4).

Operating Instructions (Cont)

2-10.5 LOADING AND UNLOADING CONTAINER (48 INCHES [122 CM] OR TALLER) TO TRUCK USING FRONT LIFT ADAPTER (FLA) (CONT).

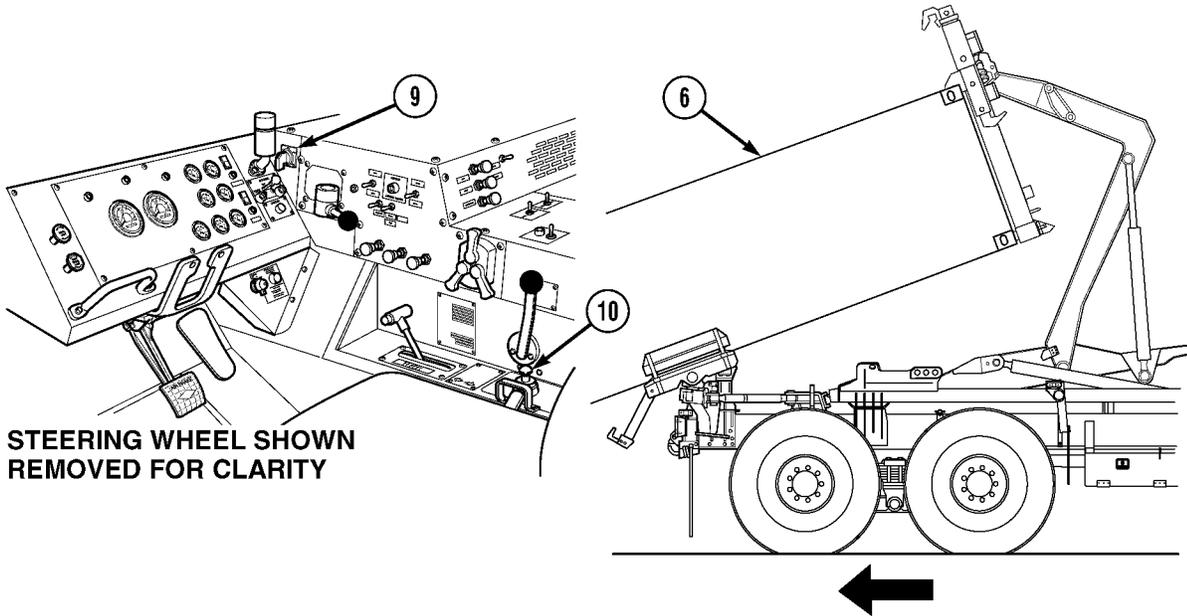

CAUTION

Engine speed must be at idle before using hydraulic selector switch, or damage to equipment may result.

NOTE

If container is being loaded in soft soil conditions, perform steps (42) through (44).

- (42) Release joystick (10). Set hydraulic selector switch (9) to MAN H.A. position.
- (43) Move joystick (10) to LOAD until container (6) is approximately 2 ft. (61 cm) off the ground. Release joystick.
- (44) Set hydraulic selector switch (9) to AUTO. Resume normal AUTO operations.

Operating Instructions (Cont)

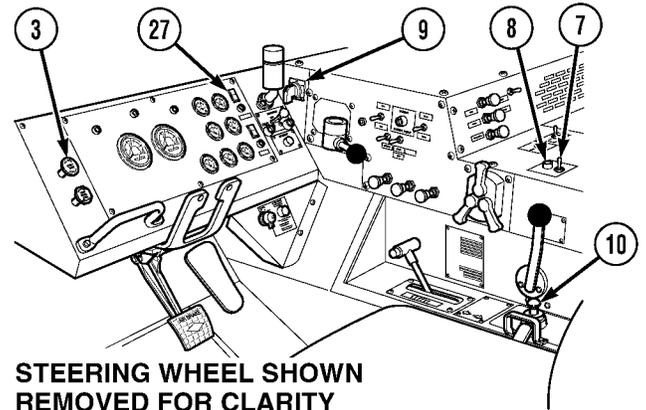
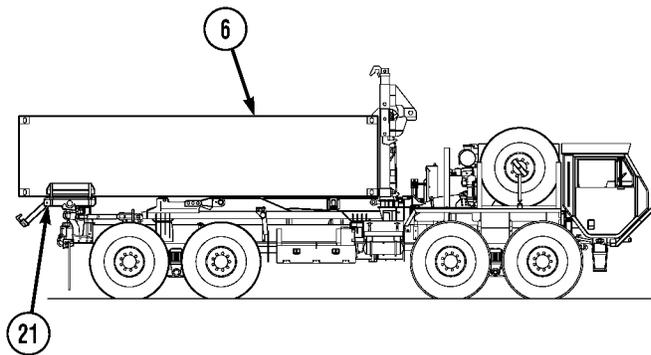

STEERING WHEEL SHOWN
REMOVED FOR CLARITY

NOTE

Engine speed may be increased and decreased to ease loading.

- (45) After container (6) contacts rear sliders (21), increase engine speed to approximately 1500 rpm until container is almost loaded. Reduce engine speed to idle.
- (46) Continue loading until container (6) is fully loaded and LHS NO TRANS lamp (27) goes out.
- (47) Release joystick (10).
- (48) Pull out parking brake knob (3) to apply parking brake.

CAUTION

- Engine speed must be at idle before using hydraulic selector switch, or damage to equipment may result.
 - Hydraulic selector switch must be in the OFF position before driving truck, or hydraulic system could overheat.
- (49) Turn hydraulic selector switch (9) to OFF.
 - (50) Put PTO engage switch (7) in OFF position. Make sure indicator light (8) goes off.
 - (51) Shut off engine (TM 9-2320-279-10).

Operating Instructions (Cont)

2-10.5 LOADING AND UNLOADING CONTAINER (48 INCHES [122 CM] OR TALLER) TO TRUCK USING FRONT LIFT ADAPTER (FLA) (CONT).

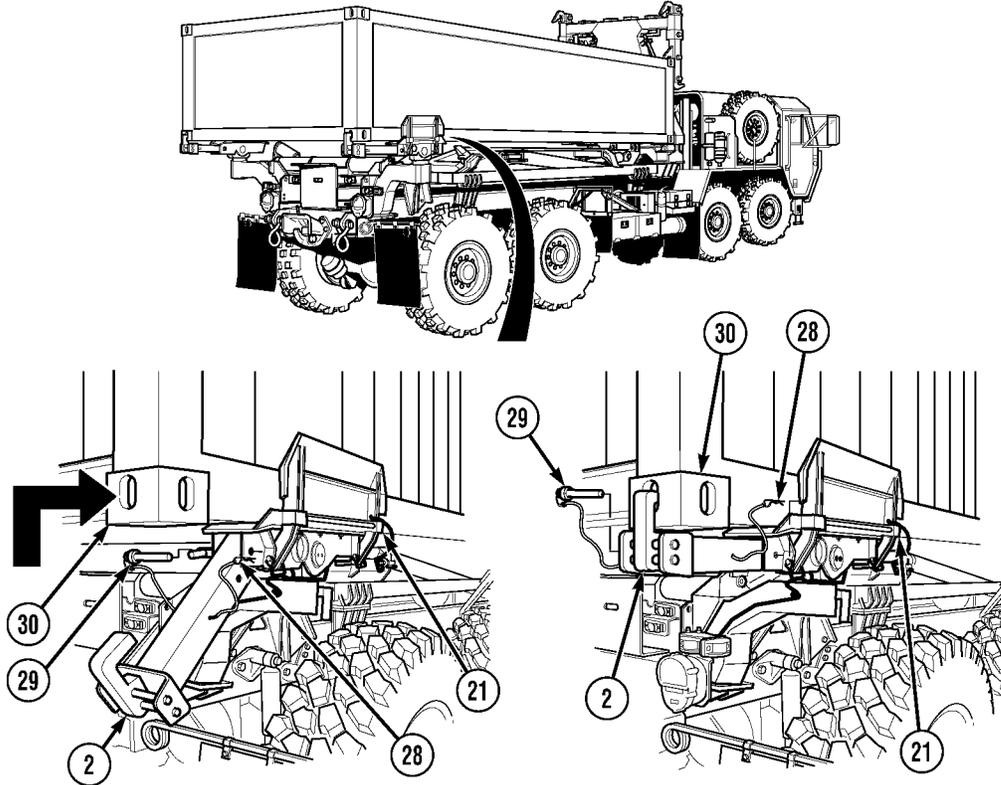

NOTE

- There are two rear container locks. Right side shown.
- If container is not centered and transit locks cannot be installed and pinned, repeat steps (40) through (51) to reposition container.

- (52) Support rear container lock (2) and remove lock pin (28) and pin (29).
- (53) Rotate rear container lock (2) up and position into container lower rear corner casting (30).
- (54) Install pin (29) and lock pin (28) in rear container lock (2) and slider (21).
- (55) Perform steps (52) through (54) for left side.

WARNING

- When loaded with FRS, the center of gravity is moved up and toward rear of truck. Extreme caution must be taken when turning and ascending or descending on a grade. Failure to use extreme caution could result in severe injury or death to personnel.
- Maximum side slope when loaded with a FRS or container is 30 percent. Failure to comply may result in equipment damage or severe injury or death to personnel.
- Do not reduce tire pressure when loaded with FRS or container. Highway tire pressure, 60 psi (414 kPa) front and 83 psi (572 kPa) rear, is required at all times when loaded with FRS or container. Failure to comply could result in damage to equipment and severe injury or death to personnel.

Operating Instructions (Cont)

b. Unloading.

WARNING

- Check for overhead power lines or other obstructions before attempting LHS operations. LHS reaches a height of 18 ft. (5.5 m). Injury or death could result if LHS contacts power lines.
- Do not attempt loading or unloading operations on a side slope greater than 5 degrees and/or fore/aft slope greater than 20 percent. Before attempting loading or unloading operations on slopes, determine if ground surface conditions permit safe loading or unloading operations. Slopes that contain snow, ice, loose gravel, or sand may not permit safe loading or unloading.
- Check ground conditions for firmness and extreme sideways inclination before picking up or off-loading a container. Any ground instability beneath road wheels could cause serious injury or death to personnel.
- Prior to and during any load or unload cycle, all personnel should stay clear of LHS, front lift adapter, and container, or serious injury or death may result.

CAUTION

- Check that ground conditions where container will be placed can support the container weight or damage to the container, front lift adapter or LHS may result.
- Use extreme caution when loading/unloading container with side doors. Container must remain centered during loading/unloading or flanges on side may be damaged and/or door hinges may make hard contact with guides.

NOTE

For detailed instructions on how to operate the LHS, refer to “LHS Controls and Indicators” (Para 2-1), “Picking Up a Flatrack in Auto Mode” (Para 2-9 b), and “Off-Loading Flatrack in Auto Mode” (Para 2-9 c).

- (1) Check area for operating room at front and rear of truck. Check overhead clearance and ground conditions.

Operating Instructions (Cont)

2-10.5 LOADING AND UNLOADING CONTAINER (48 INCHES [122 CM] OR TALLER) TO TRUCK USING FRONT LIFT ADAPTER (FLA) (CONT).

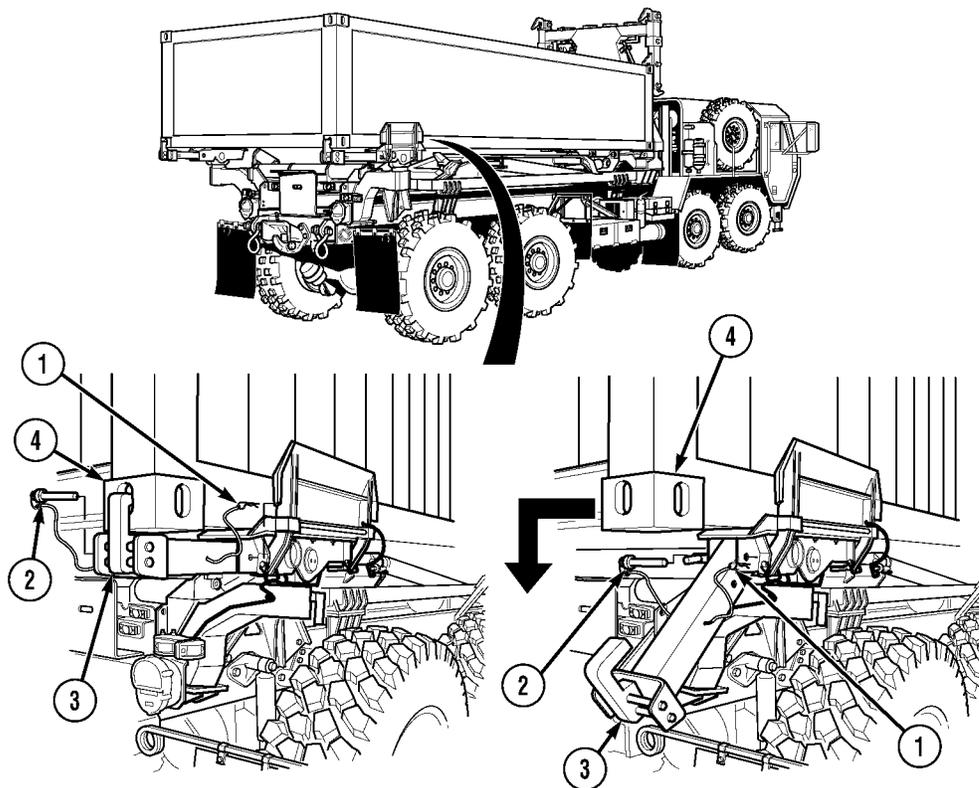

NOTE

There are two rear container locks. Right side shown.

- (2) Remove lock pin (1), pin (2), and rear container lock (3) from lower rear corner casting (4).
- (3) Rotate rear container lock (3) in down position and install pin (2) and lock pin (1).
- (4) Perform steps (2) and (3) for left side.

Operating Instructions (Cont)

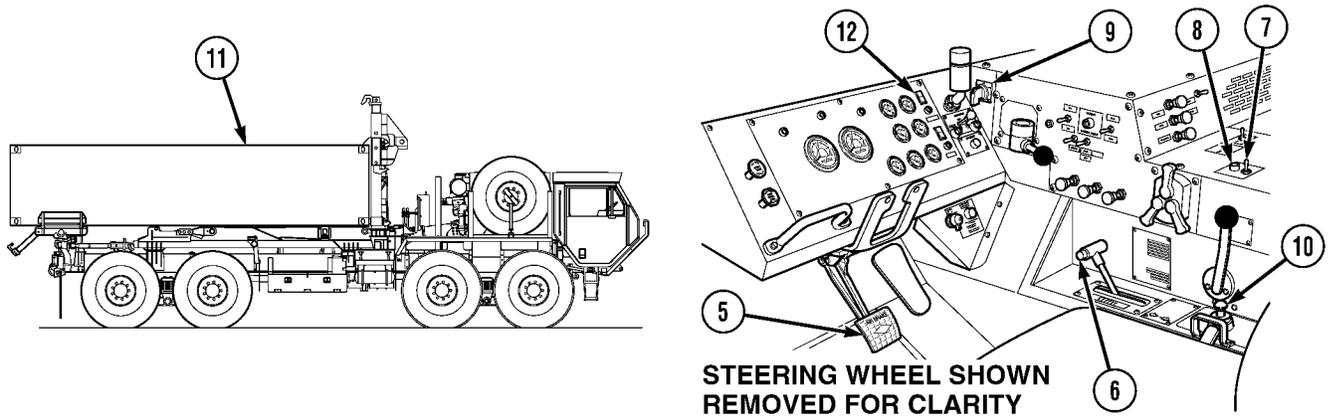

- (5) Start engine (TM 9-2320-279-10).
- (6) Apply service brake pedal (5) and set transmission range selector (6) to N (Neutral).
- (7) Put PTO ENGAGE switch (7) in ON position. Make sure indicator light (8) comes on.

CAUTION

Engine speed must be at idle before using hydraulic selector switch, or damage to equipment may result.

- (8) Turn hydraulic selector switch (9) to AUTO.

WARNING

When loading or unloading containers on uneven ground (side slope up to 5 degrees and downgrades up to 20 percent), it may be necessary to apply truck service brakes to prevent truck rollaway or severe injury or death could result.

NOTE

LHS will not operate and unload if rear container locks are engaged.

- (9) Move joystick (10) to UNLOAD. Container (11) will start to move rearward. LHS NO TRANS lamp (12) will illuminate. Maintain engine speed at idle until front of container raises approximately 12 in. (30 cm).

Operating Instructions (Cont)

2-10.5 LOADING AND UNLOADING CONTAINER (48 INCHES [122 CM] OR TALLER) TO TRUCK USING FRONT LIFT ADAPTER (FLA) (CONT).

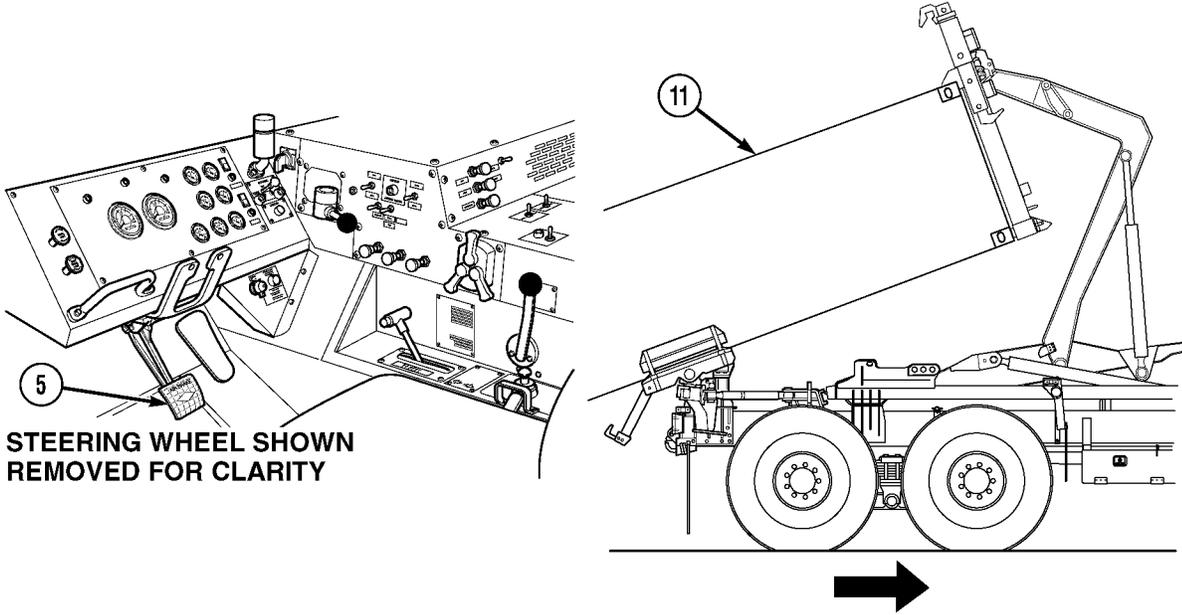

NOTE

The amount of time to load and unload is controlled by engine speed. Engine speed can be increased to approximately 1500 rpm to reduce loading and unloading times.

- (10) Continue to unload container (11) until back edge of container touches ground.
- (11) Release service brake pedal (5) and allow container (11) to push truck forward from under container.
- (12) As front of container (11) approaches within approximately 8 in. (20.3 cm) of ground, decrease engine speed to idle and apply service brake pedal (5).

Operating Instructions (Cont)

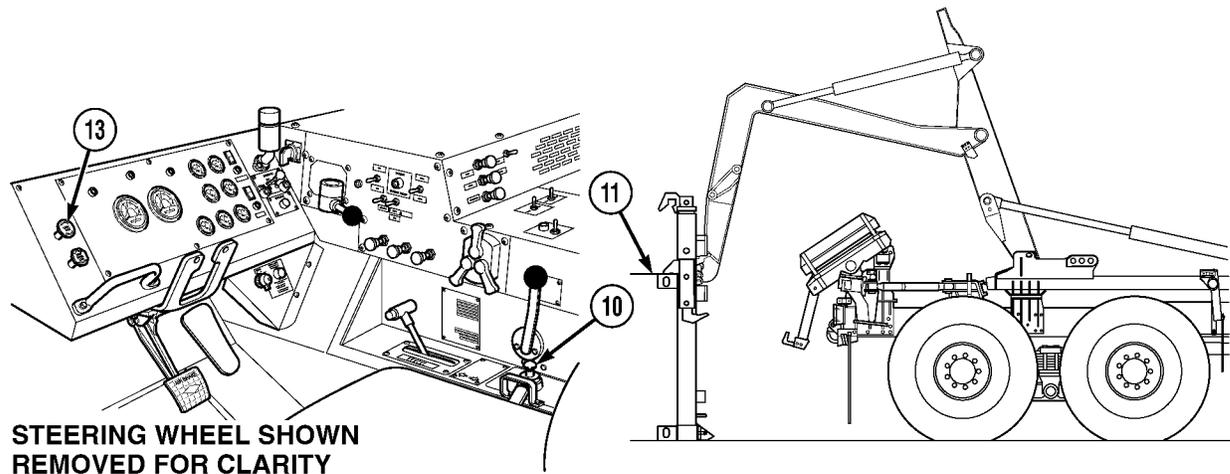
**CAUTION**

Once truck's rear suspension has been relieved of container load, do not continue in UNLOAD position as possibility of jacking up the rear of truck with hook arm may occur and damage to equipment may result.

NOTE

LHS will only operate when transmission range selector is in N (Neutral).

- (13) Continue unloading until bottom of container (11) is on ground and rear suspension is unloaded.
- (14) Release joystick (10) when container (11) is resting on ground.
- (15) Pull out parking brake knob (13) to apply parking brakes.

Operating Instructions (Cont)

2-10.5 LOADING AND UNLOADING CONTAINER (48 INCHES [122 CM] OR TALLER) TO TRUCK USING FRONT LIFT ADAPTER (FLA) (CONT).

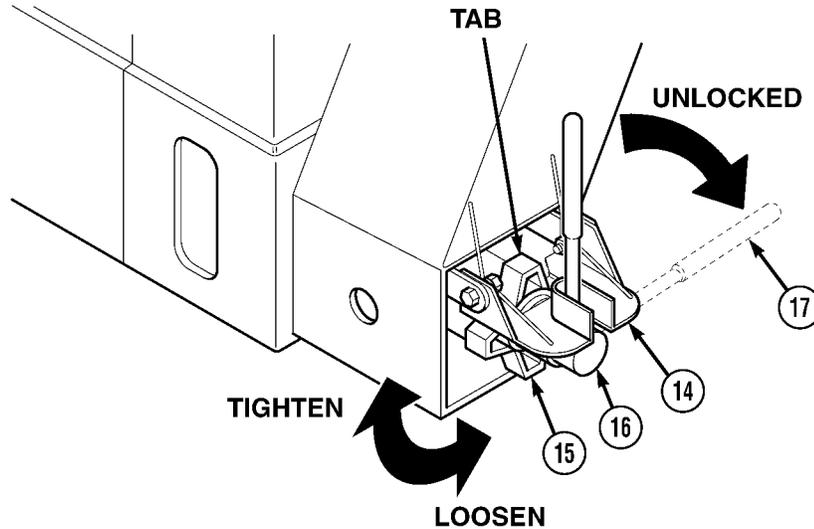

WARNING

Make sure that all tension has been relieved between LHS hook and front lift adapter prior to unlocking front lift adapter lower container locks. Stay clear of front lift adapter when unlocking front lift adapter lower container locks as front lift adapter may separate from container unexpectedly. Failure to comply may result in serious injury or death to personnel.

NOTE

There are two front lift adapter lower container locks. Right side shown.

- (16) Raise handle lock plate (14) and turn handnut (15) to loosen stem (16).

NOTE

Make sure tab on handnut faces up.

- (17) Rotate lower container lock handle (17) toward center of truck to unlocked position.
 (18) Turn handnut (15) clockwise to tighten stem (16).
 (19) Release handle lock plate (14) over container lock handle and handnut (15) tab.
 (20) Repeat steps (16) through (19) for left side.

Operating Instructions (Cont)

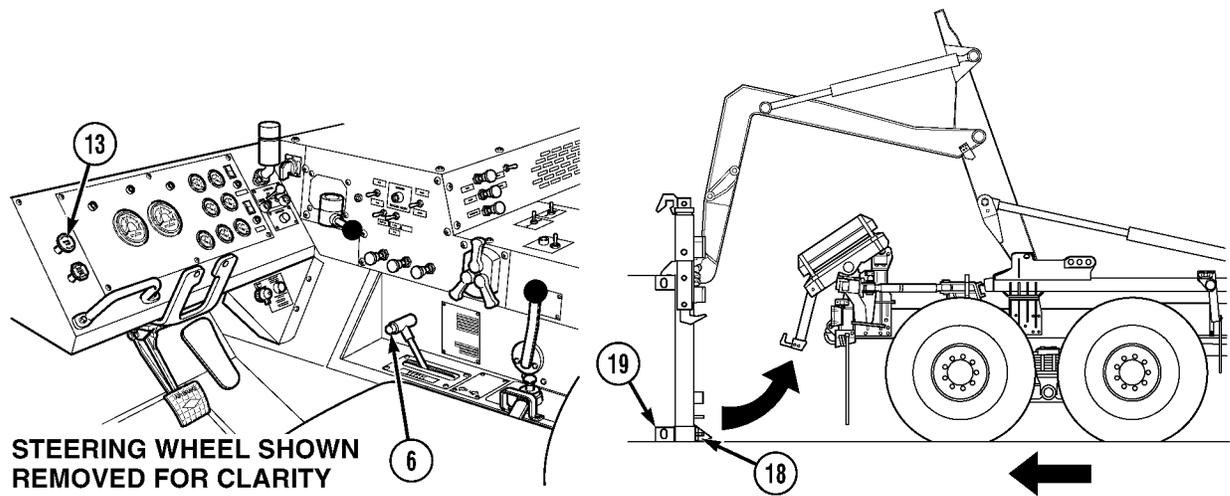

- (21) Push in parking brake knob (13) and release parking brakes. Set transmission range selector (6) to R (Reverse).
- (22) Move truck backward until lower container locks (18) disengage from lower front corner castings (19) approximately 4 to 6 in. (10 to 15 cm).

Operating Instructions (Cont)

2-10.5 LOADING AND UNLOADING CONTAINER (48 INCHES [122 CM] OR TALLER) TO TRUCK USING FRONT LIFT ADAPTER (FLA) (CONT).

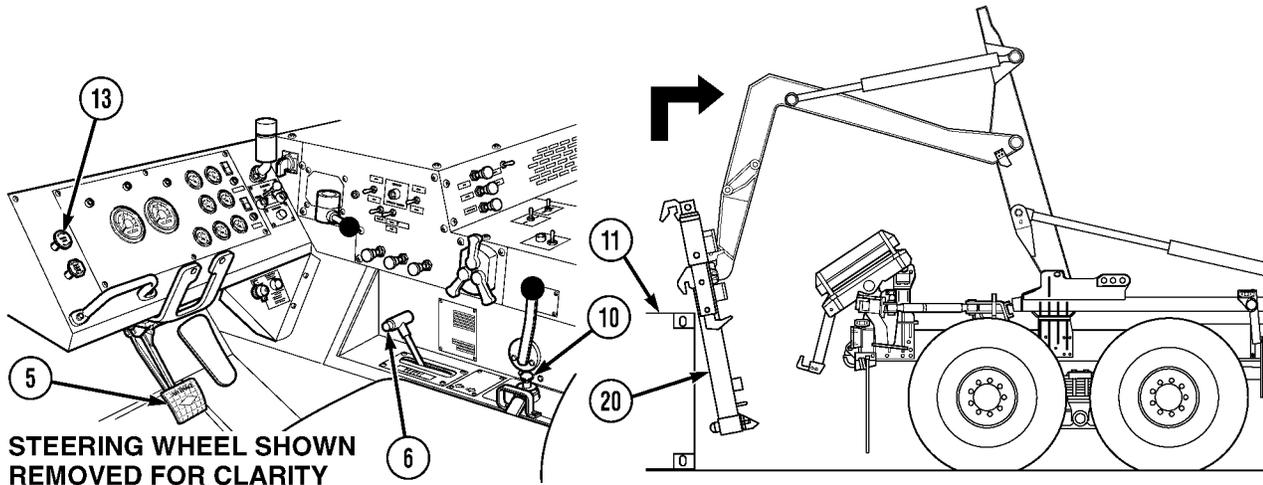

CAUTION

Make sure that the half-height container front hooks are completely disengaged and do not hang up in container upper corner castings when retracting LHS. Failure to comply may result in damage to the half-height container front hooks and/or container.

- (23) Apply service brake pedal (5) and set transmission range selector (6) to N (Neutral).

NOTE

- It may be necessary to move the truck forward or backward slightly to get the half-height container front hooks to disengage.
 - LHS will only operate when transmission range selector is in N (Neutral).
- (24) Move joystick (10) to LOAD position until front lift adapter (20) is disengaged from container (11).
- (25) Release joystick (10).
- (26) Pull out parking brake knob (13) to apply parking brakes.

Operating Instructions (Cont)

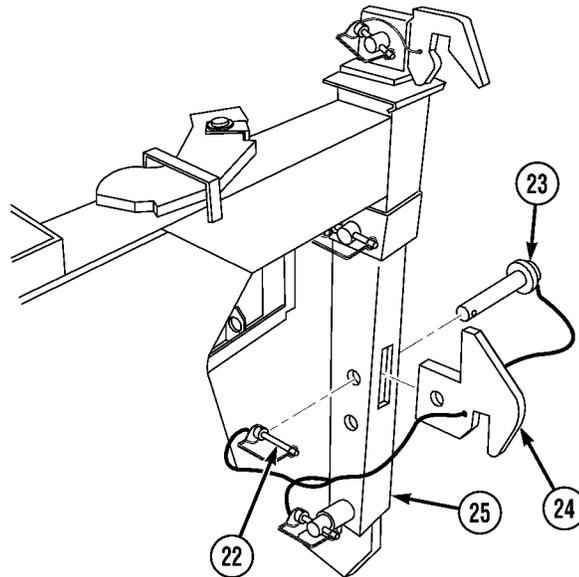
**NOTE**

- Perform steps (27) through (29) if CHU operations for 48-in. (122 cm) containers have been completed.
- There are two slide arms and half-height container front hooks. Right side shown.

(27) Remove pin lock (22), pin (23), and half-height container front hook (24) from slide arm (25).

Operating Instructions (Cont)

2-10.5 LOADING AND UNLOADING CONTAINER (48 INCHES [122 CM] OR TALLER) TO TRUCK USING FRONT LIFT ADAPTER (FLA) (CONT).

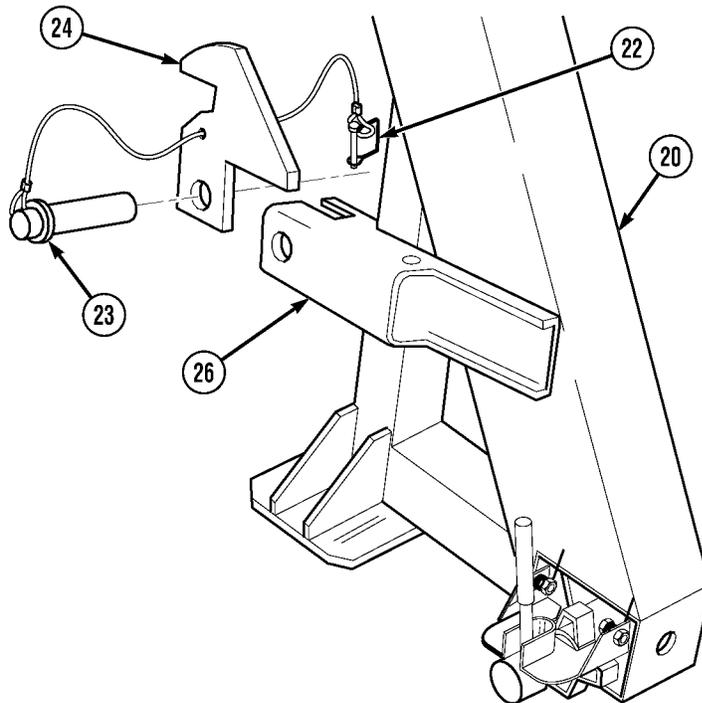

- (28) Install half-height container front hook (24), pin (23), and lock pin (22) in stowage bracket (26) on front lift adapter (20).
- (29) Repeat steps (27) and (28) for left-hand side.

Operating Instructions (Cont)

CAUTION

- On steep downgrades, contact is possible between the front lift adapter lower legs and the rear sliders during empty LHS cycles. If contact appears likely, switch hydraulic selector to MAN H.A. position and retract (LOAD) hook arm a few inches. Switch hydraulic selector to MAN M.F. position and retract the main frame until the front lift adapter clears the rear sliders. Return hydraulic selector to AUTO and continue (LOAD) operation. Failure to comply may result in damage to equipment.
- Never drive with LHS NO TRANS lamp illuminated. An illuminated lamp means that the LHS is not fully stowed. Failure to comply may result in damage to equipment.

NOTE

The amount of time to load and unload is controlled by engine speed. Engine speed can be increased to approximately 1500 rpm to reduce loading and unloading times.

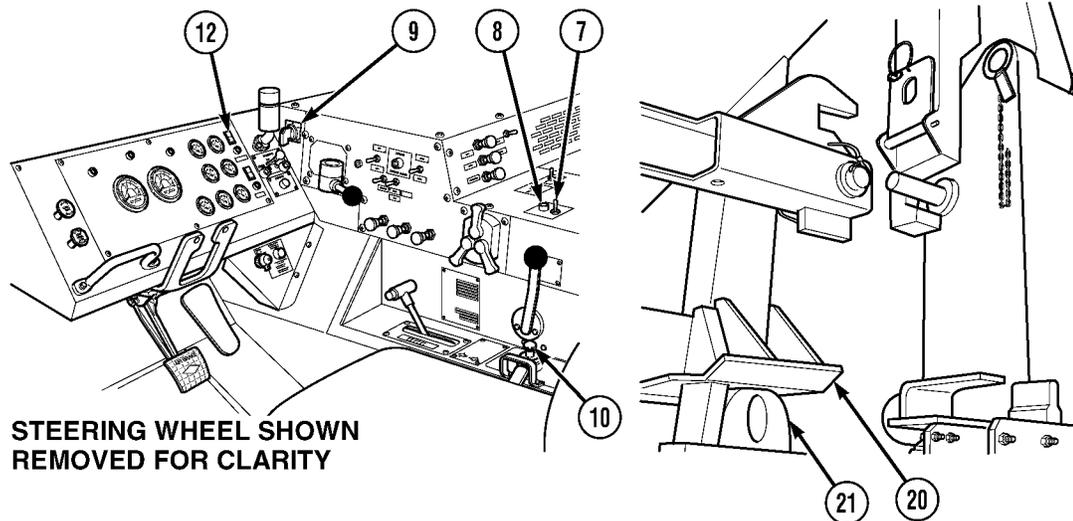

- (30) Move joystick (10) to LOAD position until LHS is fully retracted and front lift adapter (20) is positioned on bumper supports (21). LHS NO TRANS lamp (12) will go off, indicating LHS is in transport position.
- (31) Release joystick (10).

CAUTION

- Engine speed must be at idle before using hydraulic selector switch, or damage to equipment may result.
 - Hydraulic selector switch must be in the OFF position before driving truck, or hydraulic system could overheat.
- (32) Turn hydraulic selector switch (9) to OFF.
- (33) Put PTO engage switch (7) in OFF position. Make sure indicator light (8) goes off.

Operating Instructions (Cont)

2-10.6 TRANSPORT FRONT LIFT ADAPTER WITH HEMTT LHS WITHOUT CONTAINER.

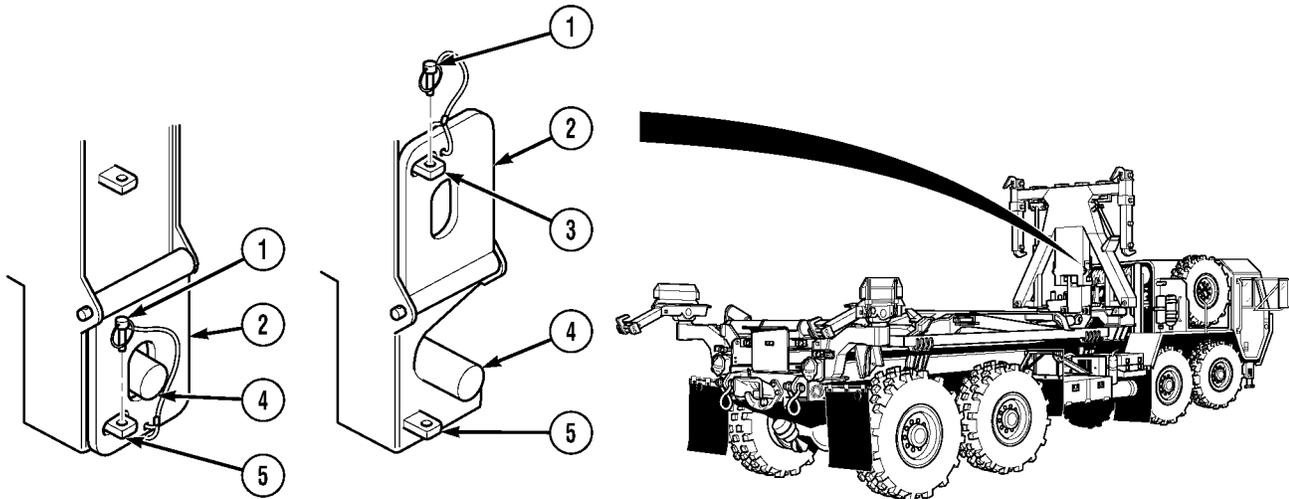

a. Front Lift Adapter in Locked Position (Transport Without Container).

WARNING

Front lift adapter weighs 1,600 lbs. (726 kg). Personnel must stay clear when installing or removing front lift adapter to LHS hook arm hook. Failure to comply may result in injury or death to personnel.

NOTE

There are two locking plates on front lift adapter. Both locking plates are locked and unlocked the same way. Right side is shown.

- (1) Remove quick release pin (1) from locking plate (2) and bracket (3).
- (2) Rotate locking plate (2) down to engage LHS hook arm pivot pin (4).
- (3) Install quick release pin (1) in locking plate (2) and bracket (5).
- (4) Repeat steps (1) through (3) for left side.

b. Front Lift Adapter in Unlocked Position (Load and Unload Container, Install or Remove Front Lift Adapter from LHS).

- (1) Remove quick release pin (1) from locking plate (2) and bracket (5).
- (2) Rotate locking plate (2) up to disengage LHS hook arm pivot pin (4).
- (3) Install quick release pin (1) in locking plate (2) and bracket (3).
- (4) Repeat steps (1) through (3) for left side.

Operating Instructions (Cont)

2-10.7 LIFT CONTAINER OUT OF MUD.**a. Using Lift Hooks to Recover Container Sunk in Mud.**

- (1) Make sure front lift adapter is in 82 in. (208 cm) or more container mode (Para 2-10.2).

WARNING

- Check for overhead power lines or other obstructions before attempting LHS operations. LHS reaches a height of 18 ft. (5.5 m). Injury or death could result if LHS contacts power lines.
- Maximum permissible gross container weight is 24,000 lbs. (10 886 kg).
- Use caution when working around front lift adapter. Front lift adapter may swing unexpectedly when not attached to container. Failure to comply may result in injury or death to personnel.
- Do not stand between front lift adapter and container. Truck could roll, crushing personnel causing serious injury or death.
- Do not attempt loading or unloading operations on a side slope greater than 5 degrees and/or fore/aft slope greater than 20 percent. Before attempting loading or unloading operations on slopes, determine if ground surface conditions permit safe loading or unloading operations. Slopes that contain snow, ice, loose gravel, or sand may not permit safe loading or unloading.

NOTE

- For detailed instructions on how to operate the LHS, refer to “LHS Controls and Indicators” (Para 2-1), “Picking Up a Flatrack in Auto Mode” (Para 2-9 b), and “Off-Loading Flatrack in Auto Mode” (Para 2-9 c).
 - Rear mud flaps may be pinned up to provide better visibility of front lift adapter lower container locks.
 - Make sure soft soil conditions around stuck container are able to support truck during recovery operation.
- (2) Start engine (TM 9-2320-279-10).

Operating Instructions (Cont)

2-10.7 LIFT CONTAINER OUT OF MUD (CONT).

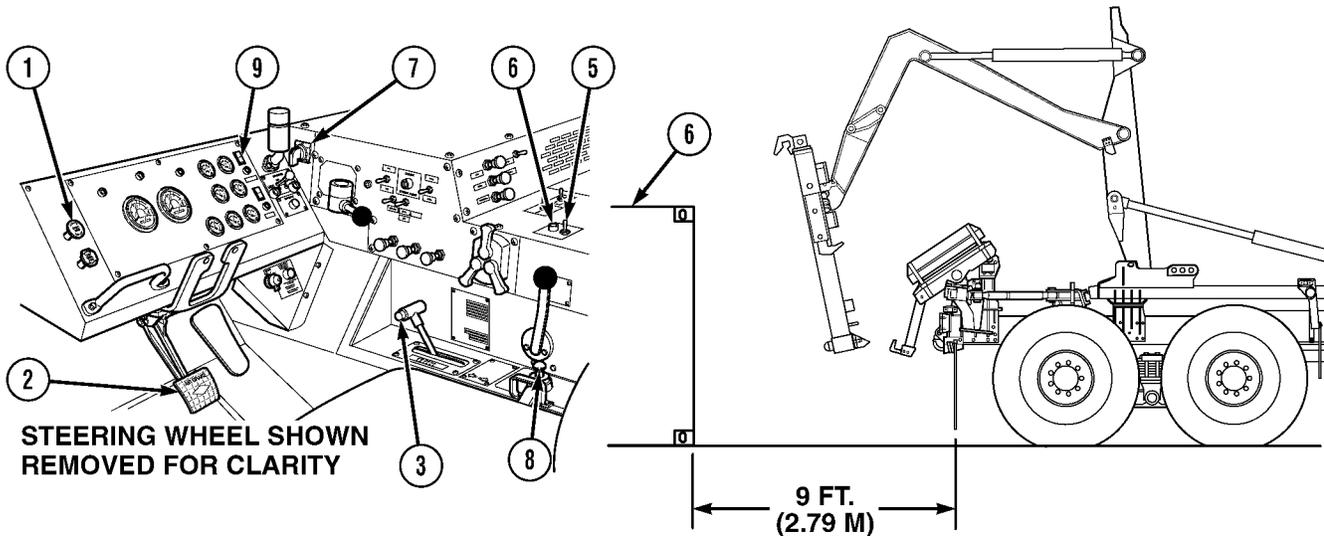

- (3) Push in parking brake knob (1), apply service brake pedal (2), and set transmission range selector (3) to R (Reverse).
- (4) Release service brake pedal (2) and position rear of truck within 9-ft. (2.74m) of front of container (4), aligning centerline of truck within 2 in. (5 cm) of container centerline.
- (5) Apply service brake pedal (2) and set transmission range selector (3) to N (Neutral).

CAUTION

Engine speed must be at idle before using hydraulic selector switch, or damage to equipment may result.

- (6) Put PTO ENGAGE switch (5) in ON position. Make sure indicator light (6) comes on.
- (7) Turn hydraulic selector switch (7) to AUTO.

CAUTION

On steep downgrades, contact is possible between the front lift adapter lower legs and the rear sliders during empty LHS cycles. If contact appears likely, switch hydraulic selector to MAN H.A. position and retract (LOAD) hook arm a few inches. Return hydraulic selector to AUTO and continue (UNLOAD) operation. Repeat as required. Failure to comply may result in damage to equipment.

- (8) Move joystick (8) to UNLOAD. Hook arm will raise and begin to move rearward. LHS NO TRANS lamp (9) will illuminate to indicate hook arm is up and load lock has been cleared.

Operating Instructions (Cont)

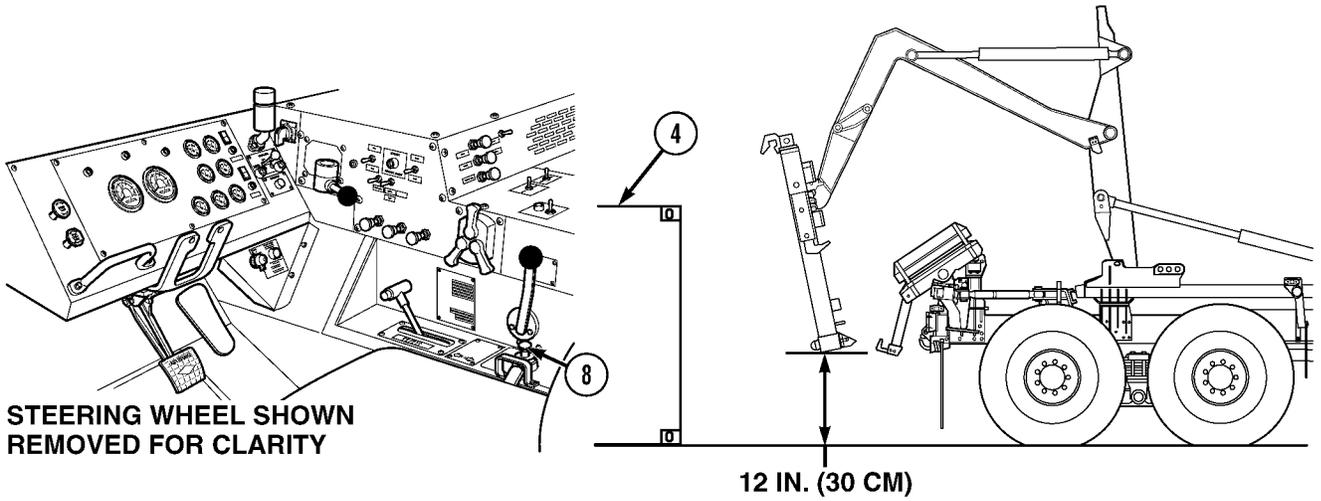

- (9) Continue to hold joystick (8) in UNLOAD position until front lift adapter (10) is approximately 12 in. (30 cm) off the ground.
- (10) Release joystick (8).
- (11) Shut off engine (TM 9-2320-279-10).

Operating Instructions (Cont)

2-10.7 LIFT CONTAINER OUT OF MUD (CONT).

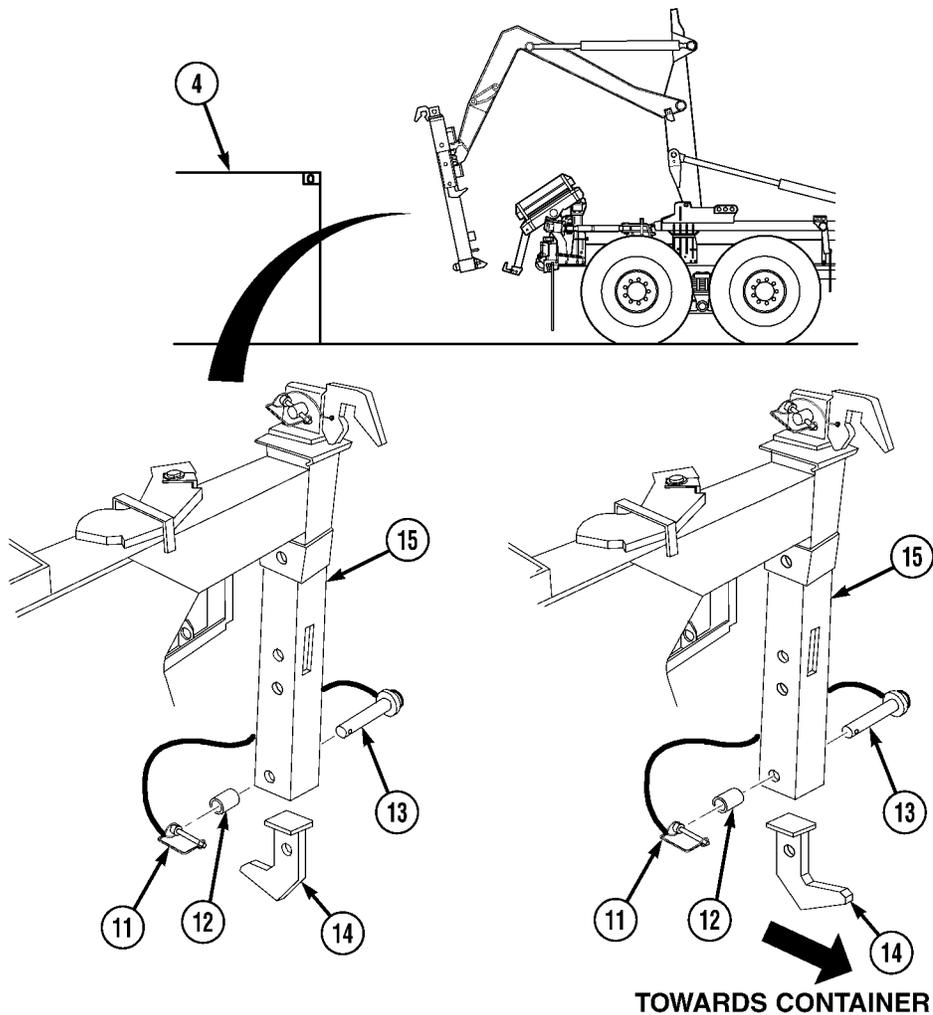

NOTE

There are two lift hooks. Both are installed same way. Right side shown.

- (12) Remove lock pin (11), collar (12), pin (13), and lift hook (14) from slide arm (15).
- (13) Rotate lift hook (14) toward container (4).
- (14) Install lift hook (14), pin (13), collar (12), and lock pin (11) in slide arm (15).

Operating Instructions (Cont)

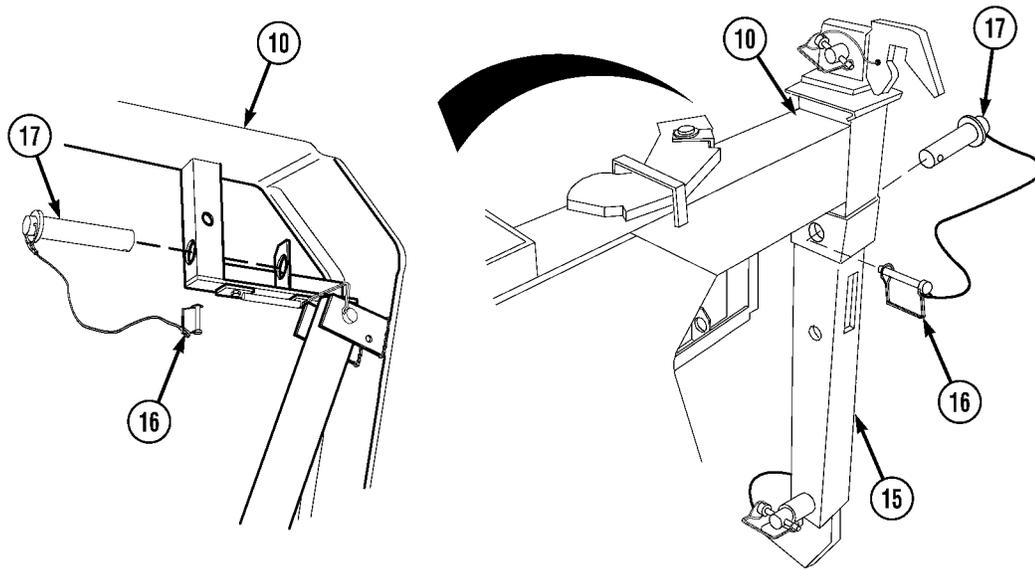

- (15) Remove lock pin (16) and pin (17) from stow position on front lift adapter (10).
- (16) Install pin (17) and lock pin (16) in front lift adapter (10) slide arm (15) in upper hole.
- (17) Repeat steps (12) through (16) for left side.

Operating Instructions (Cont)

2-10.7 LIFT CONTAINER OUT OF MUD (CONT).

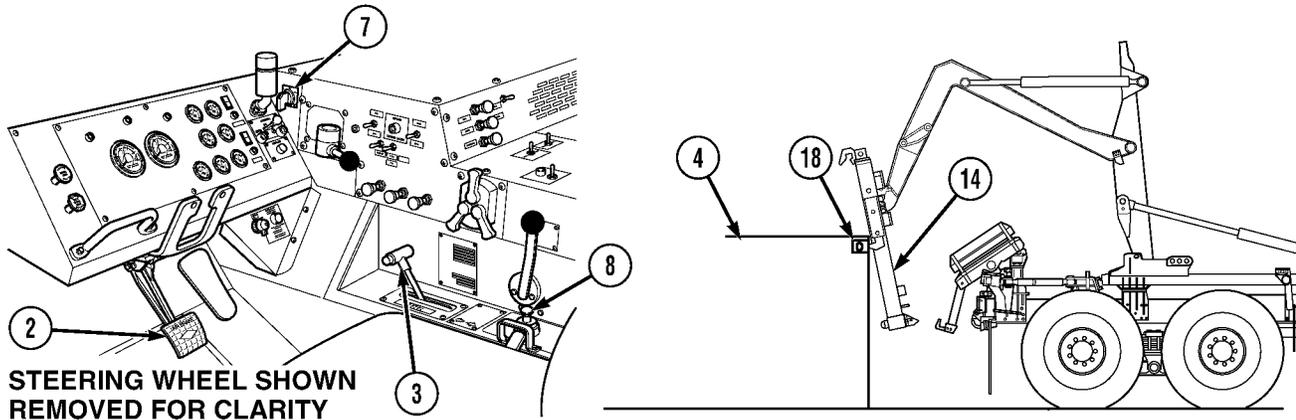

- (18) Start engine (TM 9-2320-279-10).
- (19) Move joystick (8) to load and raise front lift adapter until lift hooks (14) are aligned with container top ISO corners (18) on container (4).
- (20) Apply service brake pedal (2) and set transmission range selector (3) to R (Reverse).

CAUTION

Make sure slide arm lift hooks are fully engaged with container upper corner castings. Failure to comply may result in damage to equipment.

NOTE

LHS will only operate when transmission range selector is in N (Neutral).

- (21) Release service brake pedal (2). Position lift hooks (14) in container top ISO corners (18) on container (4).
- (22) Apply service brake pedal (2). Put transmission range selector in N (Neutral).
- (23) Turn hydraulic selector switch (7) to MAN H.A. position.

Operating Instructions (Cont)

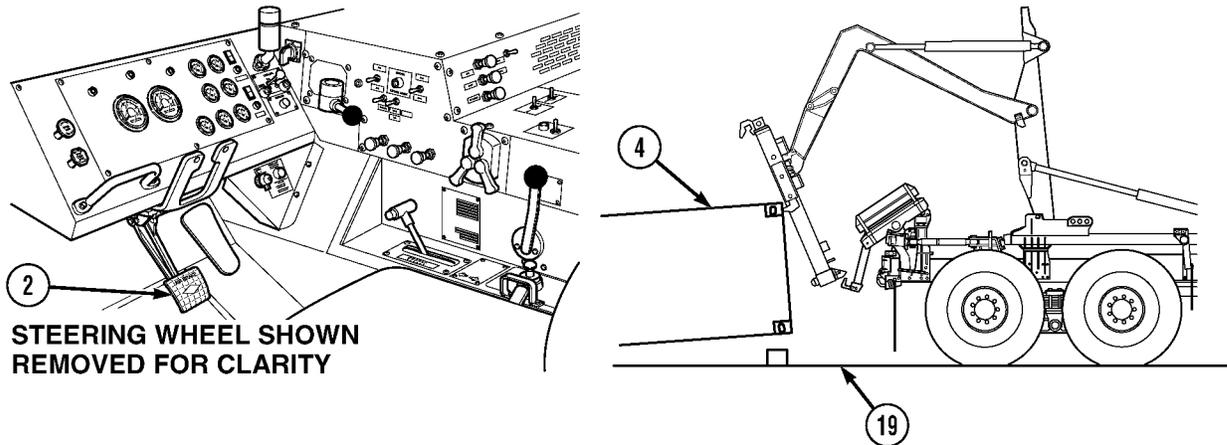
**WARNING**

Make sure lower container locks do not contact container. If lower container locks contact container lift hooks will disengage container causing container to drop and front lift adapter to become erratic. Failure to comply may result in injury or death to personnel.

- (24) While Soldier A operates truck and Soldier B assist, slowly lift up container (4) with LHS until lower corner castings are approximately 6 in. (15 cm) from container.
- (25) Release service brake pedal (2) and back truck up approximately 12 in. (30 cm).
- (26) Apply service brake pedal (2).
- (27) Repeat steps (24) through (26) until front of container (4) is out of mud and chock blocks (19) can be positioned under container.

WARNING

Do not put hands, arms, or any body parts under container when positioning chock blocks. Failure to comply may result in injury or death to personnel.

- (28) Position two chock blocks (19) under container (4) end.
- (29) Lower LHS to position container (4) on chock blocks (19) and disengage lift hooks (14) from container.

Operating Instructions (Cont)

2-10.7 LIFT CONTAINER OUT OF MUD (CONT).

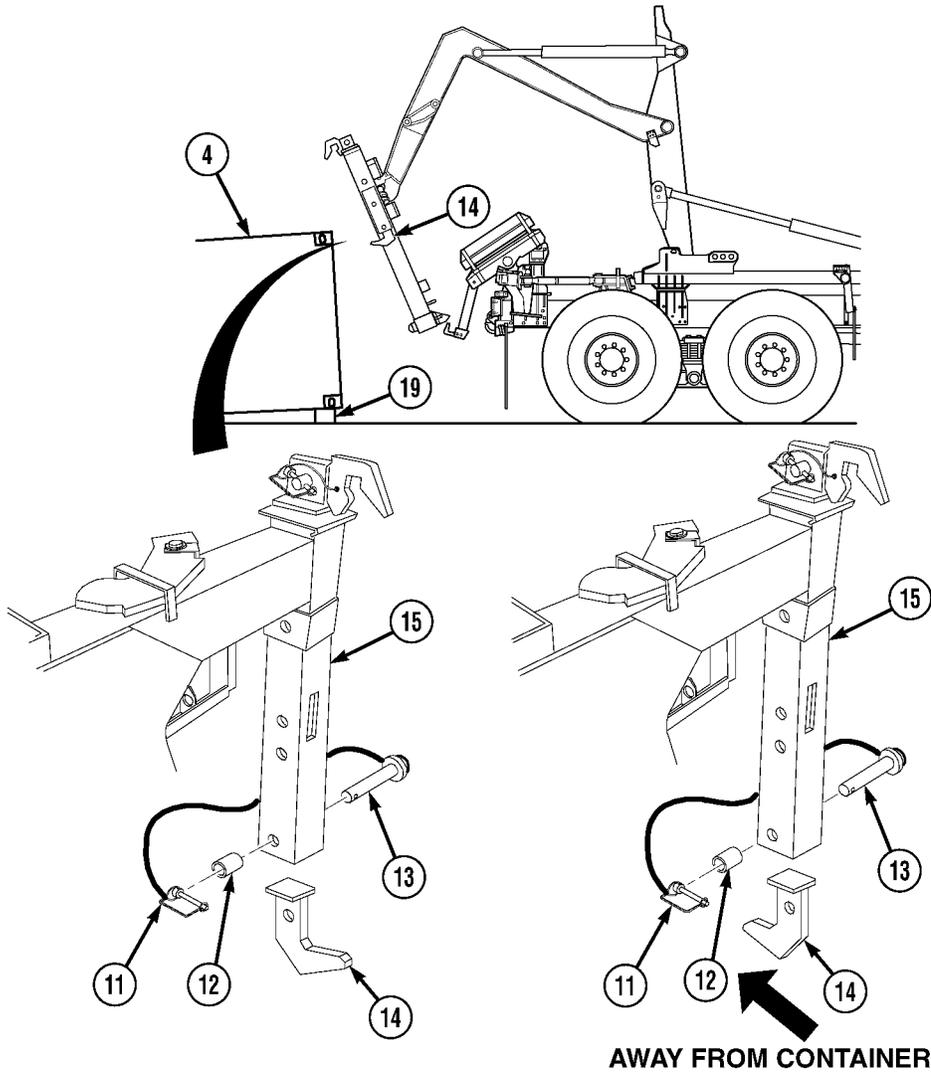

- (30) Remove lock pin (11), collar (12), pin (13), and lift hook (14) from slide arm (15).
- (31) Rotate lift hook (14) away from container (4).
- (32) Install lift hook (14), pin (13), collar (12), and lock pin (11) in slide arm (15).
- (33) Repeat steps (30) through (32) for left side.

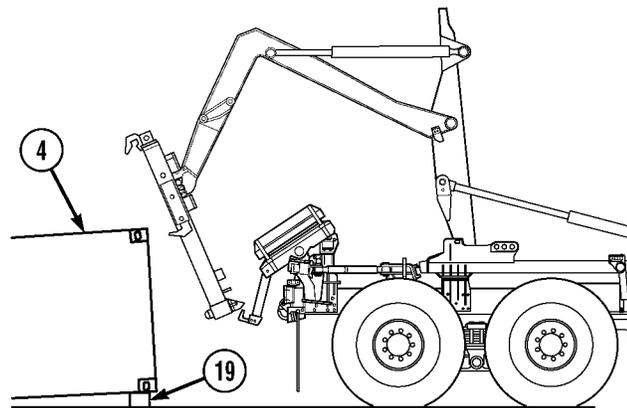
Operating Instructions (Cont)

- (34) Attach front lift adapter to container (4), following normal container loading procedures, refer to applicable container (Para 2-10 through 2-10.5).
- (35) Raise container (4) end 12 in. (30 cm).

WARNING

Do not put hands, arms, or any body parts under container when positioning chock blocks. Failure to comply may result in injury or death to personnel.

- (36) Remove and stow chock blocks (19).

NOTE

See loading and unloading container (Para 2-10 through 2-10.5) for additional instructions.

Operating Instructions (Cont)

2-10.8 STACKING/LOADING M3 CROP ON TRAILER.

a. Loading and Unloading.

NOTE

- Refer to TM 9-3990-260-14&P for CROP Stack/Unstacking procedures.
- Refer to Para 2-9 for Load Handling System (LHS) operation to load/unload CROPs onto truck.
- Once CROPs are loaded on truck, they are loaded onto trailer using the following procedures.
- The M3/M3A1 CROP should be loaded as close to the center of gravity point as possible. As the payload reached the maximum lifting capacity of the HEMTT LHS; if a load is not centered on the CROP the center of gravity can restrict the lifting capability of the truck. Approximate center of gravity is 111 in. (centered) from the front edge of the CROP

- (1) Remove CROP loading ramps from their storage location on trailer.

CAUTION

There are left and right side CROP loading ramps. For proper operation, ramps must be engaged on correct side of trailer. Failure to comply may result in equipment damage

NOTE

- There are two CROP loading ramps, right and left side. Right side CROP loading ramp shown.
- For proper engagement and operation of CROP loading ramps, the following installation instructions must be followed.

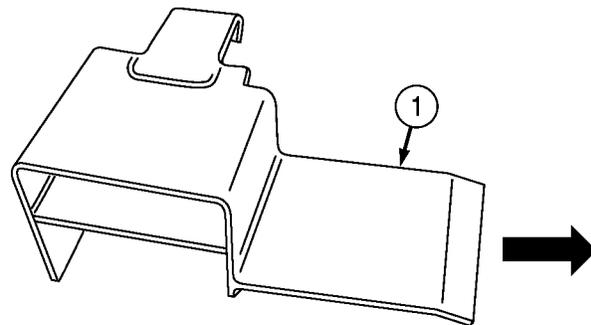

- (2) Position CROP loading ramps with sloped portion (1) facing forward on trailer frame bed, toward trailer tongue.

Operating Instructions (Cont)

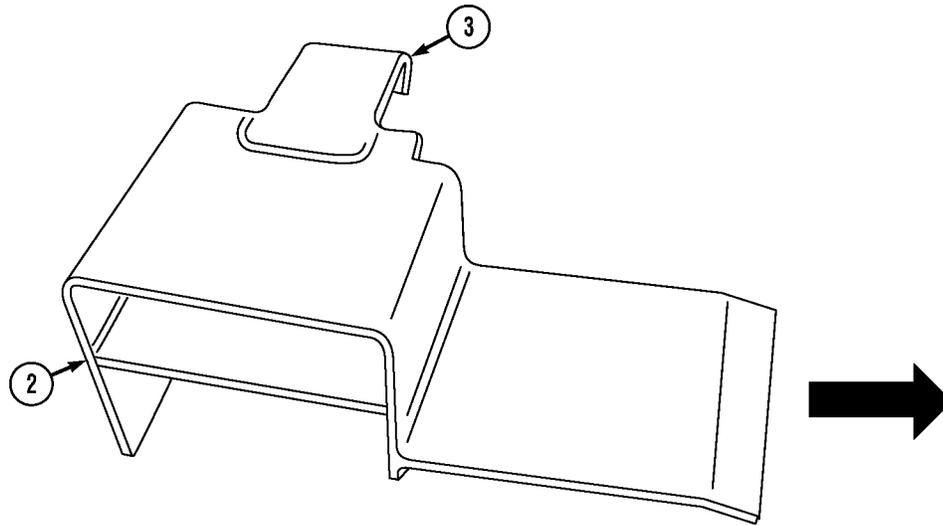

- (3) With squared back portion (2) of CROP loading ramp flush against and contacting trailer stops, engage hook portion (3) over inboard trailer guide rail.
- (4) Repeat Steps (2) and (3) for left side CROP loading ramp.

WARNING

Make sure all personnel stand clear of CROP when CROP is being moved. Failure to comply may result in severe injury or death to personnel.

CAUTION

If right and left ramps are not properly positioned, equipment damage may result.

- (5) Load CROPs onto trailer (Para 2-9.f.).

Operating Instructions (Cont)

2-10.9 LOADING/UNLOADING ISO CONTAINER WITH M3 CROP.

a. Loading

WARNING

- CROP weighs 3,800 lbs. (1 724 kg). Six CROPs weigh 22,800 lbs. (10 342 kg). Make sure all personnel stand clear of CROP when CROP is being moved. Failure to comply may result in severe injury or death to personnel.
- Always lift stack of CROPs by connecting lifting device to bottom CROP. Failure to comply may result in damage to equipment or severe injury or death to personnel.

CAUTION

- Attempting to load/unload stack of CROPs or loaded CROP in ISO container requires extreme care to prevent damage to equipment. Clearance between ceiling of ISO container and top of load and inside walls of ISO container and each side of CROP is designed to be close, requiring at least one ground guide to assist during difficult insertion/removal procedure.
- Make sure web straps securing stack of CROPs are removed prior to insertion into ISO container. Failure to comply may result in damage to web straps during insertion procedure.

NOTE

- Stack of six CROPs is maximum that can be loaded into ISO container.
- The use of ramps during loading/unloading process is optional.

- (1) Open ISO container doors (1) and secure in open position.
- (2) Remove web straps securing CROPs.
- (3) Back truck up to approximately 15 ft. (4.6 m) from ISO container door opening.
- (4) Unload CROP (2) until bottom CROP rollers (3) are approximately 12 in. (30 cm) from ground (Para 2-9.c.).

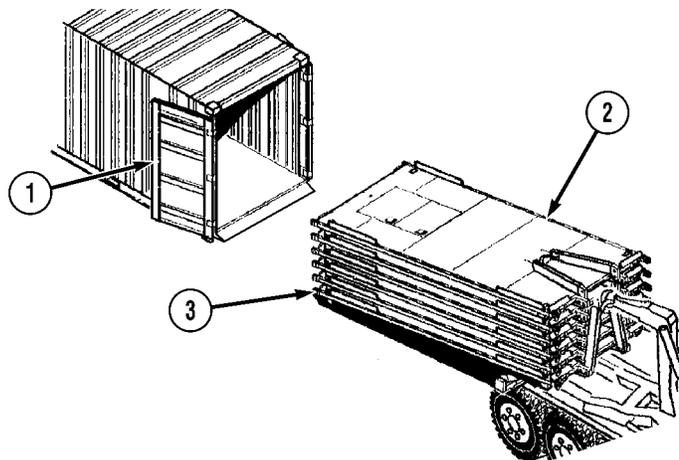

Operating Instructions (Cont)

WARNING

Do not stand between CROP and ISO container. Make sure all personnel stand clear of CROP when CROP is being moved. Failure to comply may result in severe injury or death to personnel.

CAUTION

M3 CROP is designed to fit into door opening of 91 in. (231 cm). If container is more than 10 years old, door opening may not be wide enough. **DO NOT** attempt to force CROP into containers with door openings less than 91 in. (231 cm). Failure to comply will result in damage to equipment.

NOTE

- If CROP load is too tall to insert into ISO container according to steps (5) and (6), perform steps (7) through (9), then proceed to step (10).
- Several attempts to insert CROP may be required because ISO container door opening is only slightly wider than CROP.

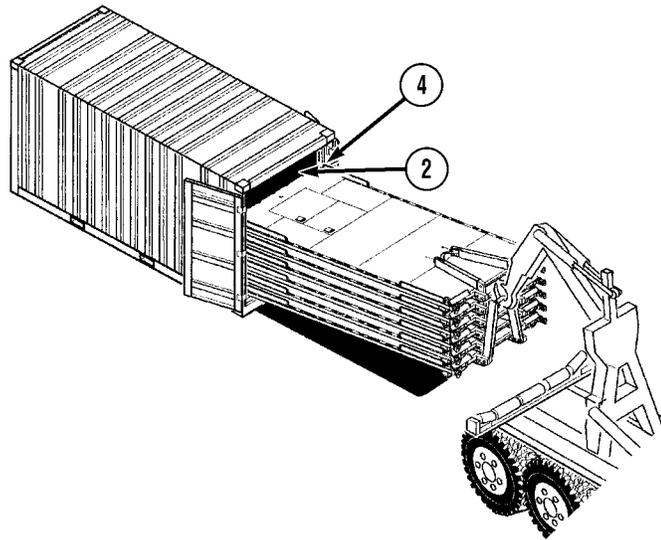

- (5) Using at least one ground guide, carefully back truck up and insert rear of CROP (2) approximately 24 in. (61 cm) into ISO container (4).

Operating Instructions (Cont)

2-10.9 LOADING/UNLOADING ISO CONTAINER WITH M3 CROP (CONT).

CAUTION

Extreme caution must be used to make sure bottom CROP rollers remain inside ISO container. Failure to comply may result in damage to equipment.

- (6) Move joystick to UNLOAD, allowing truck to be pushed forward, until front of CROP (2) is approximately 12 in. (30 cm) from ground. Proceed to step (10).

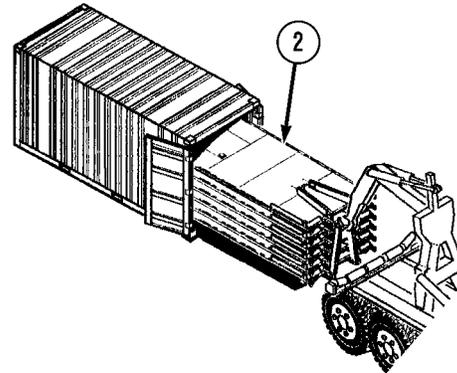

- (7) Position ISO container loading platforms (5) on ground, in front of and against ISO container door opening so CROP rollers (3) can roll up container loading platforms (5) into ISO container.
- (8) Unload CROP (2) until bottom CROP rollers (3) are grounded in front of ISO container loading platforms (5) and front of CROP (2) is approximately 12 to 18 in. (30 to 46 cm) from ground.
- (9) Using at least one ground guide, use truck to push CROP (2) up loading platforms (5) and into ISO container.

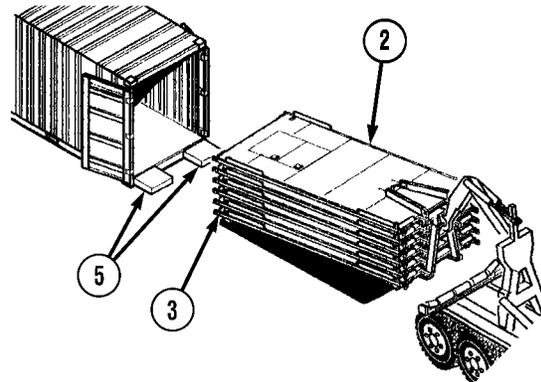

CAUTION

Make sure CROPs do not contact top of ISO container door opening or inside walls of ISO container. Failure to exercise extreme caution during insertion may result in damage to ISO container or CROP.

- (10) Using at least one ground guide, back truck up until CROP front twist lock truck up until CROP front twist lock housings are inside ISO container.
- (11) If CROP appears to be out of alignment inside ISO container:
 - (a) Stop truck. Pull truck and CROP forward several feet. Back up truck and realign CROP.
 - (b) After CROP has been properly realigned, back truck up until CROP front twist lock housings are inside ISO container.

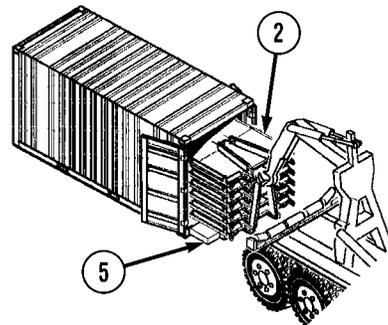

Operating Instructions (Cont)

- (12) Move joystick to UNLOAD position until CROP is resting on ISO container floor. Disconnect hook from CROP, and move truck forward approximately 3 ft. (.9 m).
- (13) Remove loading platforms (5).
- (14) Attach hook arm extension (6) to hook arm (7).

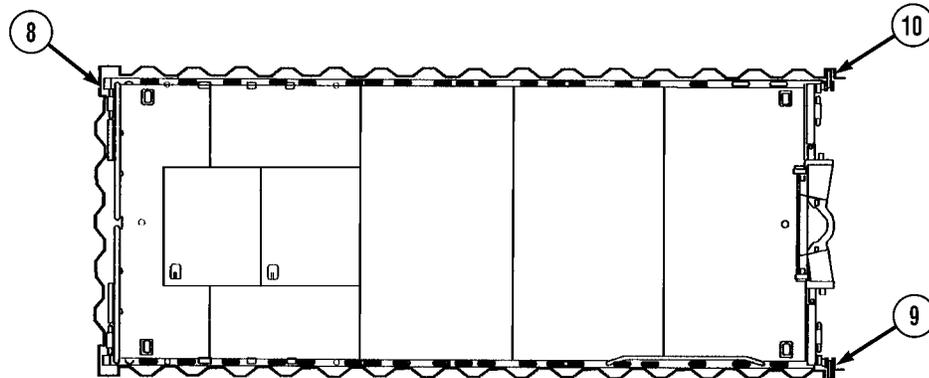
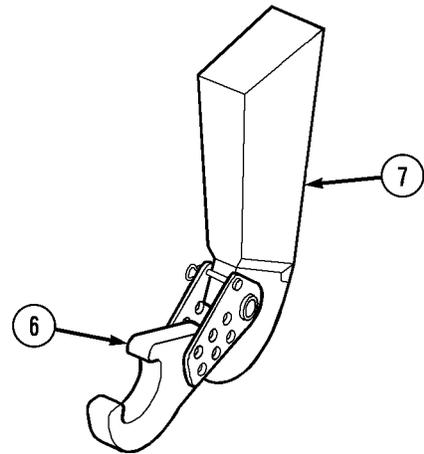

WARNING

Always lift stack of CROPs by connecting lift device to bottom CROP. Failure to comply may result in damage to equipment or severe injury or death to personnel.

- (15) Connect hook arm extension to bottom CROP. Lift and push CROP into ISO container until CROP rear bumpers (8) firmly contact front of ISO container and bracing mechanism cams (9) can be positioned into shoring slots (10) on both sides of ISO container door.
- (16) Disconnect hook arm extension from CROP and drive truck forward so ISO container doors can be closed.
- (17) Remove and stow hook arm extension assembly (6) from hook arm (7).

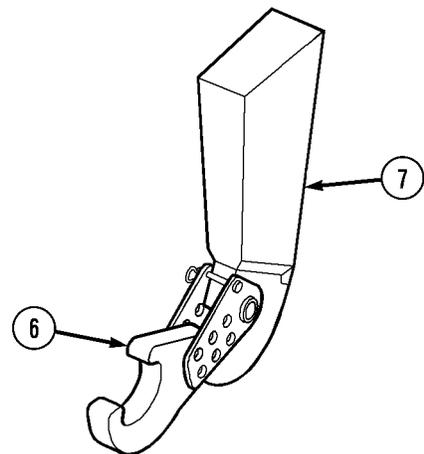

Operating Instructions (Cont)

2-10.9 LOADING/UNLOADING ISO CONTAINER WITH M3 CROP (CONT).

NOTE

The bracing mechanisms consist of a free-to-rotate cam positioned between two collars welded to threaded rod. The front adjustment collar is equipped with holes, which a pin can be inserted to provide leverage to turn and adjust the cam position fore and aft, enabling it to engage the shoring slot. The same pin is used to secure cam after engaged in shoring slot.

- (18) Rotate cams (9) in left and right bracing mechanisms until shoring slots (10) on both sides of ISO container are engaged.
- (19) If cam (9) will not engage shoring slot (10), insert pin (11) into adjustment collar (12) and turn, adjusting cam (9) forward or aft until cam (9) will engage shoring slot (10).

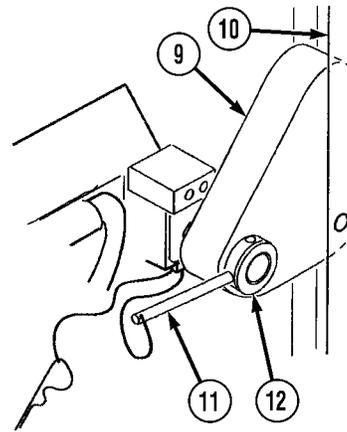

NOTE

Depending upon CROP distance from shoring slots, cams will engage in one of two positions depicted below as Nominal Position and Minimum Position. If required, use a forklift to position CROP so either Nominal or Minimum position can be achieved.

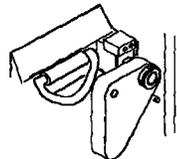

NON-USE STOWED

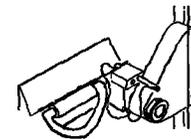

NOMINAL USE

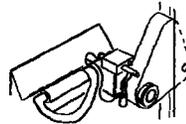

MINIMUM USE

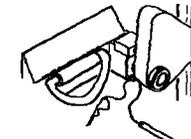

UNACCEPTABLE POSITION FOR EITHER SIDE

Operating Instructions (Cont)

- (20) Using pin (11), turn adjustment collar (12) until cam (9) is pushed positioned tight against front of shoring slot (10).

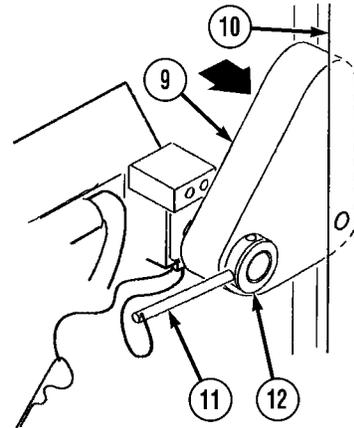

NOTE

Outside hole is preferred in step (20). Pin ensures that cam cannot be dislodged during transit.

- (21) Insert pin (11) into one of the two holes in cam securing block (13).
- (22) Insert hitch pin clip (14) into pin (11).

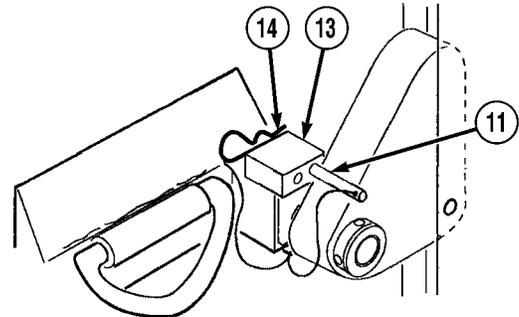

NOTE

If stack of CROPs is the load, repeat Steps (18) through (22) on bottom CROP and at least every other CROP in stack.

- (23) Close and secure ISO container doors.

b. Unloading.

- (1) Open ISO container doors (1) and secure in open position.

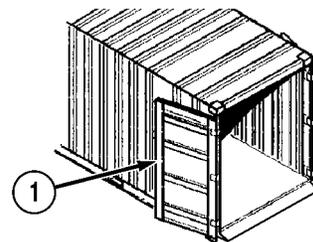

- (2) Remove hitch-pin clip (2) and pin (3) from cam securing block (4).

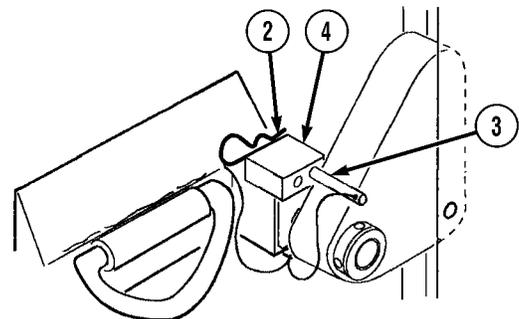

Operating Instructions (Cont)

- (3) Using pin (3), turn adjustment collar (5) until cam (6) is free from shoring slot (7).

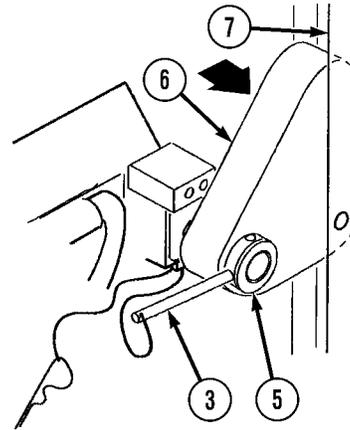

- (4) Install hook arm extension assembly (8) on hook arm (9).

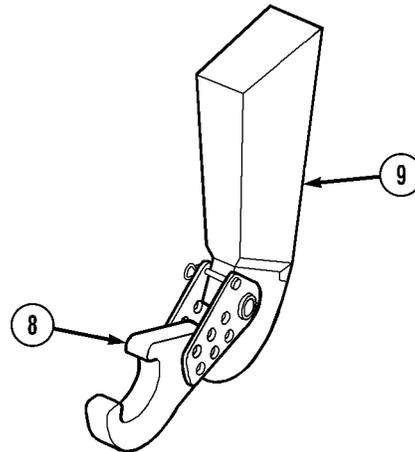

Operating Instructions (Cont)

WARNING

Always lift stack of CROPs by connecting lifting device to bottom CROP. Failure to comply may result in damage to equipment or severe injury or death to personnel.

CAUTION

- Attempting to load/unload stack of CROPs or loaded CROP in ISO container requires extreme care to prevent damage to equipment. Clearance between ceiling of ISO container and top of load and inside walls of ISO container and each side of CROP is designed to be close, requiring at least one ground guide to assist during difficult insertion/removal procedure.
 - Make sure CROPs do not contact top of ISO container door opening or inside walls of ISO container. Failure to exercise extreme caution during removal may result in damage to ISO container or CROP.
- (5) Connect hook extension assembly (8) to bottom CROP (10). Lift CROP and move truck forward until CROP front twist lock housings are outside ISO container.
 - (6) Remove and stow hook arm extension assembly (8) from hook arm (9).
 - (7) Connect hook arm (9) to bottom CROP (10).

WARNING

CROP weighs 3,800 lbs. (1 724 kg). Six CROPs weigh 22,800 lbs. (10 342 kg). Make sure all personnel stand clear of CROP when CROP is being moved. Failure to comply may result in severe injury or death to personnel.

CAUTION

Make sure CROPs do not contact top of ISO container door opening or inside walls of ISO container. Failure to exercise extreme caution during insertion may result in damage to ISO container or CROPs.

NOTE

If CROP load is too tall to remove from ISO container according to step (8), perform steps (9) through (11).

- (8) Move joystick to LOAD and load CROPs (10) onto truck.
- (9) Position ISO container loading platforms (11) on ground, in front of and against ISO container door opening, so CROP rollers (12) can roll down platforms (11) out of ISO container.
- (10) Put transmission range selector in D (Drive); move truck forward until CROP rollers are out of ISO container.
- (11) Move joystick to LOAD and load CROPs (10) onto truck.

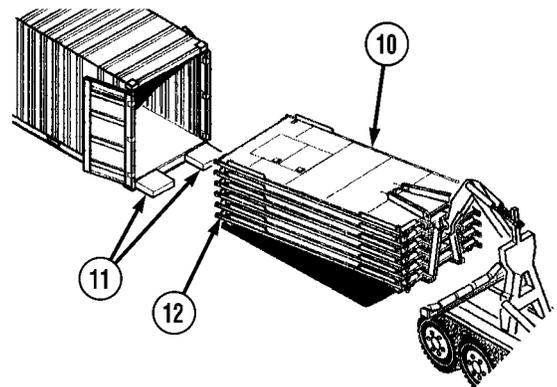

Operating Instructions (Cont)

2-10.10 RAIL TRANSPORT.

a. Rail Transport Strut Installation.

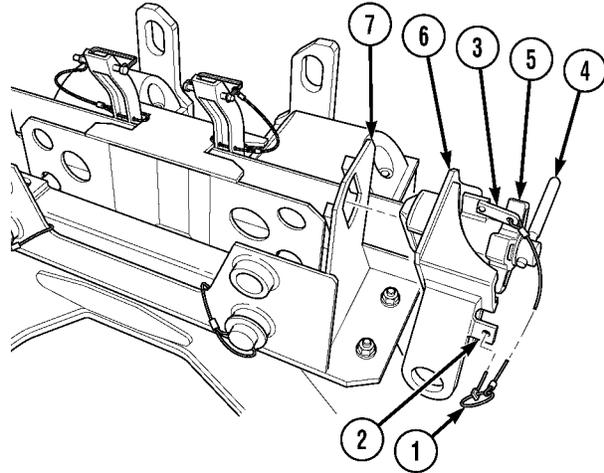
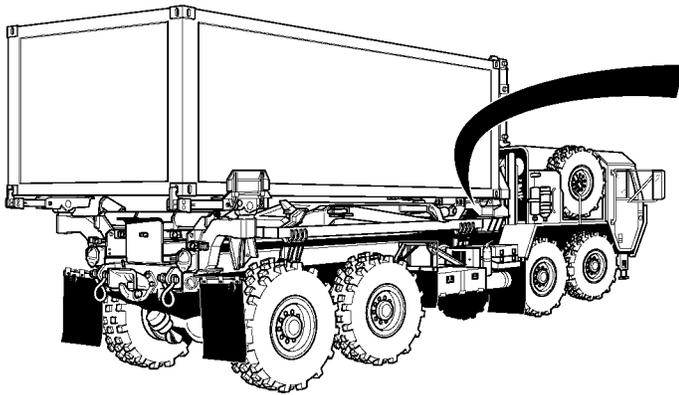

NOTE

- Make sure ISO lower corner castings are free of dirt and debris.
- There are two ISO corner locks. Both are installed the same way. Right side shown.
- Make sure container is fully loaded on truck and rear container locks are installed (Para 2-10.2 through Para 2-10.5).

- (1) Remove lock pin (1) from bracket (2) and lift tab (3) to unlock handle (4).
- (2) Loosen handnut (5), rotate lock handle (4) 90 degrees, and remove ISO corner lock (6) from stowage tray (7).

Operating Instructions (Cont)

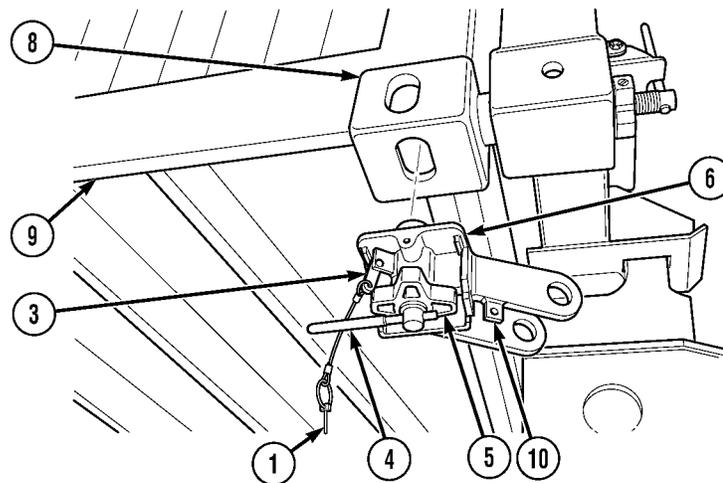

- (3) Position ISO corner lock (6) in front bottom corner casting (8) of ISO container (9).

NOTE

ISO corner lock handle will point toward front or rear of truck when in locked position.

- (4) Rotate lock handle (4) 90 degrees to locked position and tighten handnut (5).
 (5) Rotate tab (3) down to lock handnut (5) and install lock pin (1) in bracket (10).

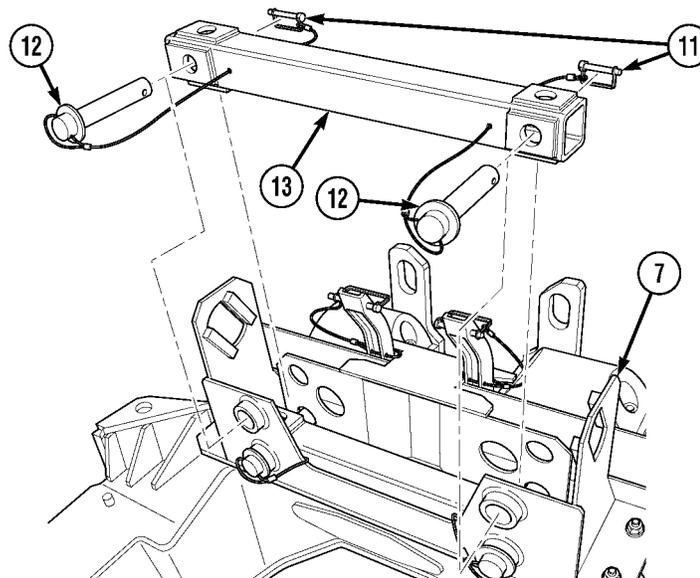

WARNING

Rail transport struts weigh 60 lbs. (27 kg). Use the aid of Soldier B when installing or removing rail strut. Failure to comply may result in injury to personnel.

- (6) Remove two lock pins (11), pins (12), and rail transport strut (13) from stowage tray (7).

Operating Instructions (Cont)

2-10.10 RAIL TRANSPORT (CONT).

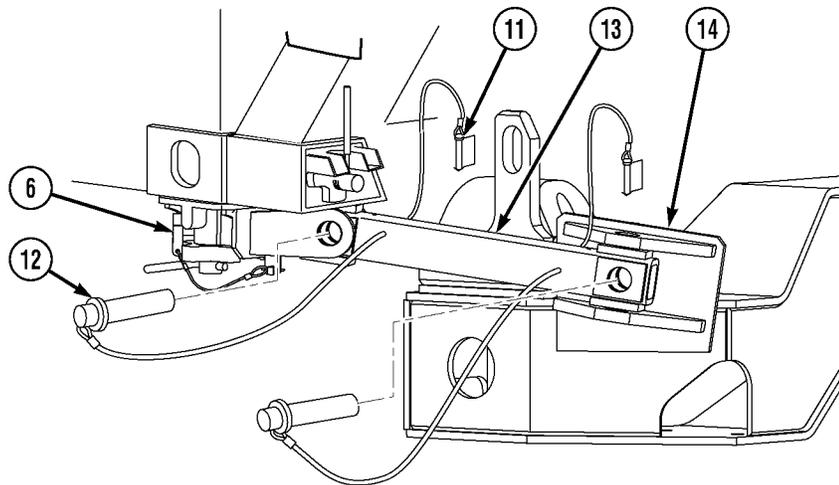

NOTE

- There are two different lengths to the rail transport strut: one stenciled “L” for longer hole placement and another stenciled “S” for shorter hole placement.
- Depending on which length is required, align to correct hole on front container support.
- See Para 2-9 for additional operating instructions.
- ISO corner lock may have to be loosened and repositioned to install pins.

- (7) Position rail transport strut (13) between front container support (14) and ISO corner lock (6).
- (8) Install rail transport strut (13) to ISO corner lock (6) with pin (12) and lock pin (11).

Operating Instructions (Cont)

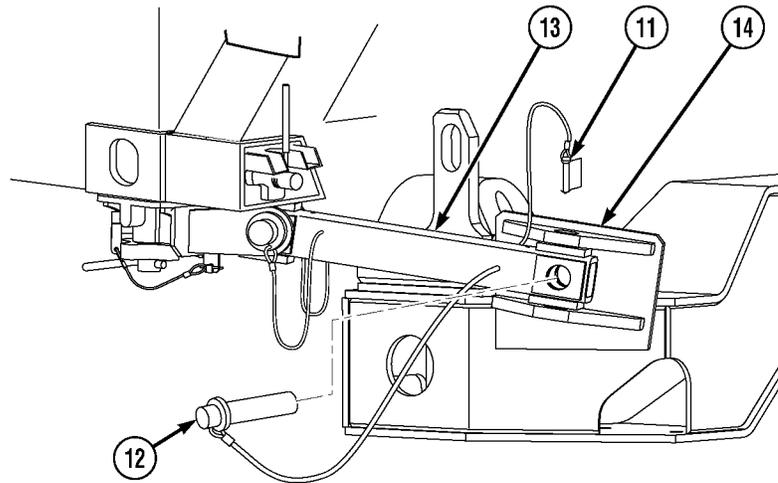

NOTE

It may be necessary to rotate rail transport strut 90 degrees to align holes.

- (9) Position rail transport strut (13) with either hole on front container support (14).
- (10) Install pin (12) and lock pin (11) to rail transport strut (13) and front container support (14).
- (11) Repeat steps (1) through (10) for left side.

b. Rail Transport Strut Removal.

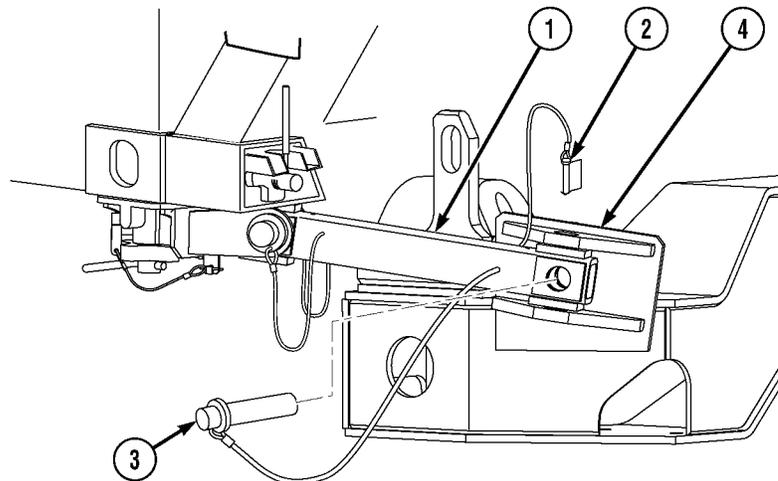

NOTE

There are two rail transport struts and ISO corner locks. Both are removed the same way. Right side shown.

- (1) Support rail transport strut (1), remove lock pin (2) and pin (3).

Operating Instructions (Cont)

2-10.10 RAIL TRANSPORT (CONT).

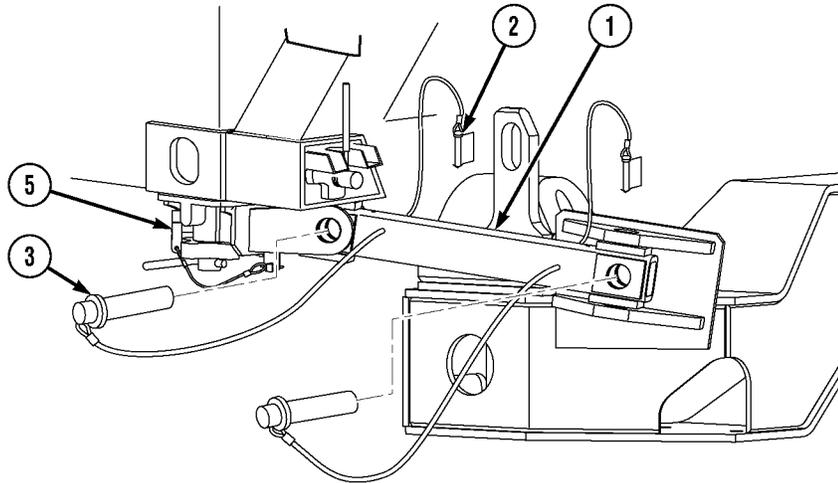

WARNING

Rail transport struts weigh 60 lbs. (27 kg). Use the aid of Soldier B when installing or removing rail strut. Failure to comply may result in injury to personnel.

- (2) Remove lock pin (2), pin (3), and rail transport strut (1) from ISO corner lock (5).

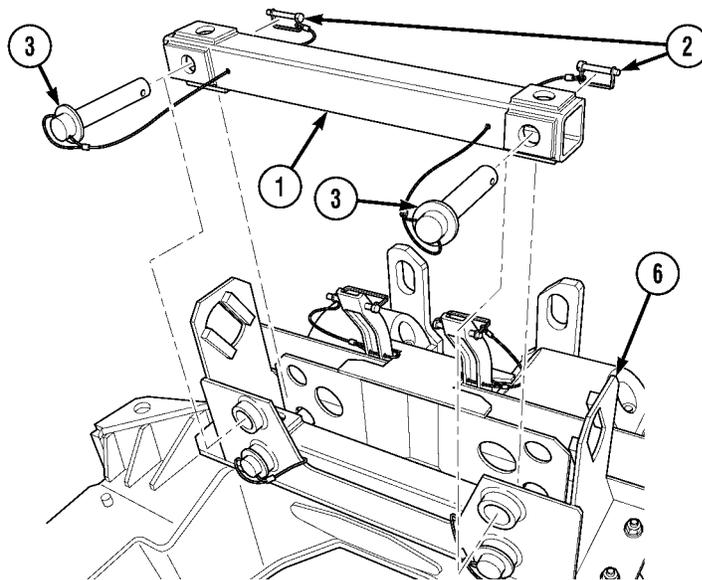

NOTE

Rail transport struts are positioned on stowage tray in “S” shorter hole placement, with “S” facing outward.

- (3) Position rail transport strut (1) on stowage tray (6). Install two pins (3) and lock pins (2).

Operating Instructions (Cont)

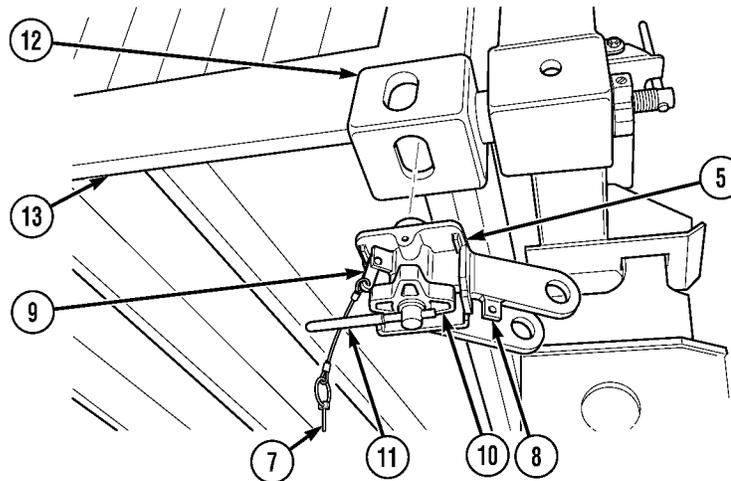

- (4) Remove lock pin (7) from bracket (8) and rotate tab (9) up.

WARNING

ISO corner lock will become loose from front bottom corner casting of ISO container when performing step (5).

- (5) Loosen handnut (10), rotate lock handle (11) 90 degrees, and remove ISO corner lock (5) from front bottom corner casting (12) of ISO container (13).

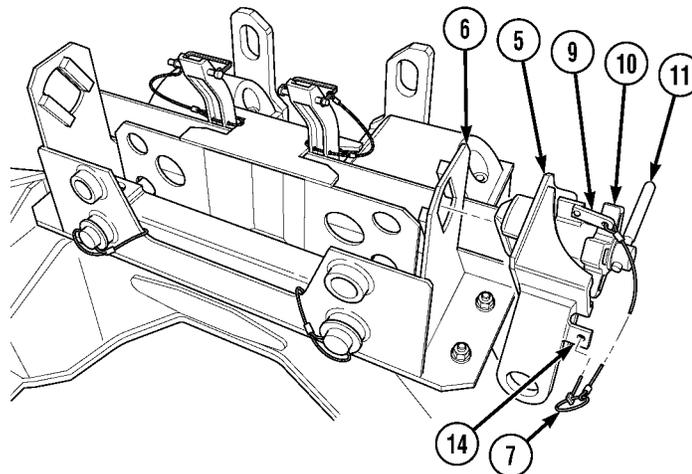

- (6) Install ISO corner lock (5) on stowage tray (6) and rotate lock handle (11) 90 degrees.
- (7) Tighten handnut (10), rotate tab (9) to lock handnut (10), and install lock pin (7) in bracket (14).
- (8) Repeat steps (1) through (7) for left side.

Operating Instructions (Cont)

2-10.11 REMOVING AND INSTALLING FRONT LIFT ADAPTER FROM TRUCK.

a. Removing Front Lift Adapter from Truck.

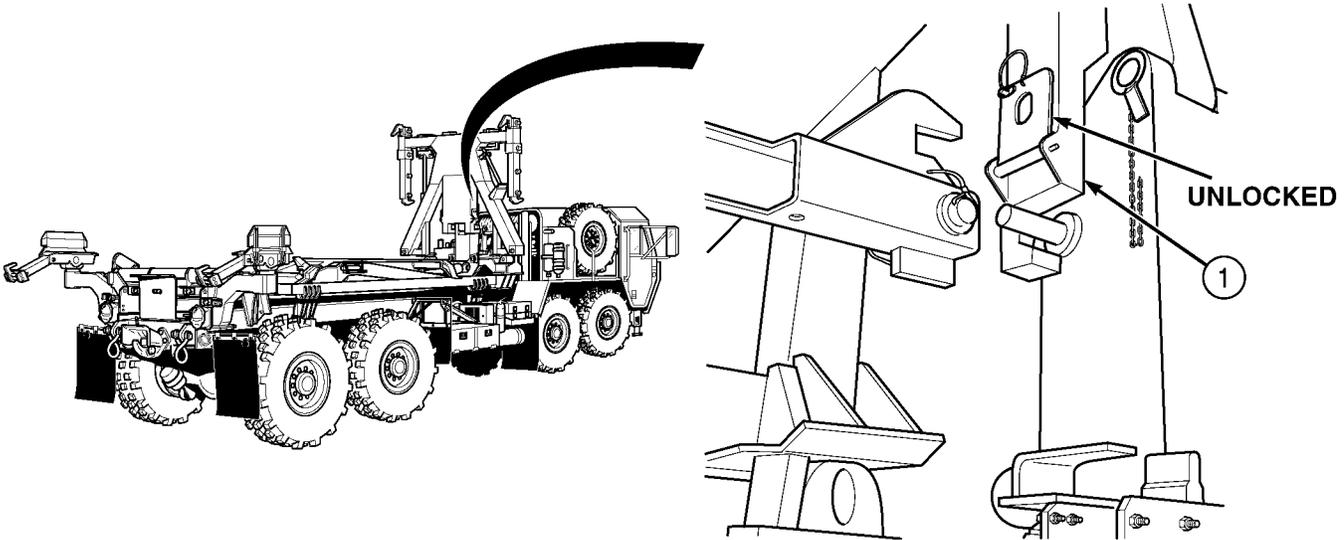

WARNING

- Front lift adapter weighs 1,600 lbs. (726 kg). Personnel must stay clear when installing or removing front lift adapter to LHS hook arm hook. Failure to comply may result in injury or death to personnel.
- Front lift adapter must be unloaded on a flat, level surface. Failure to comply may result in front lift adapter tipping over unexpectedly, causing injury or death to personnel.

NOTE

- Prepare an area to set front lift adapter. Make sure the area is accessible for the truck.
- Perform step (1) if front lift adapter is in locked position.

(1) Position front lift adapter (1) in unlocked position (Para 2-10.6).

Operating Instructions (Cont)

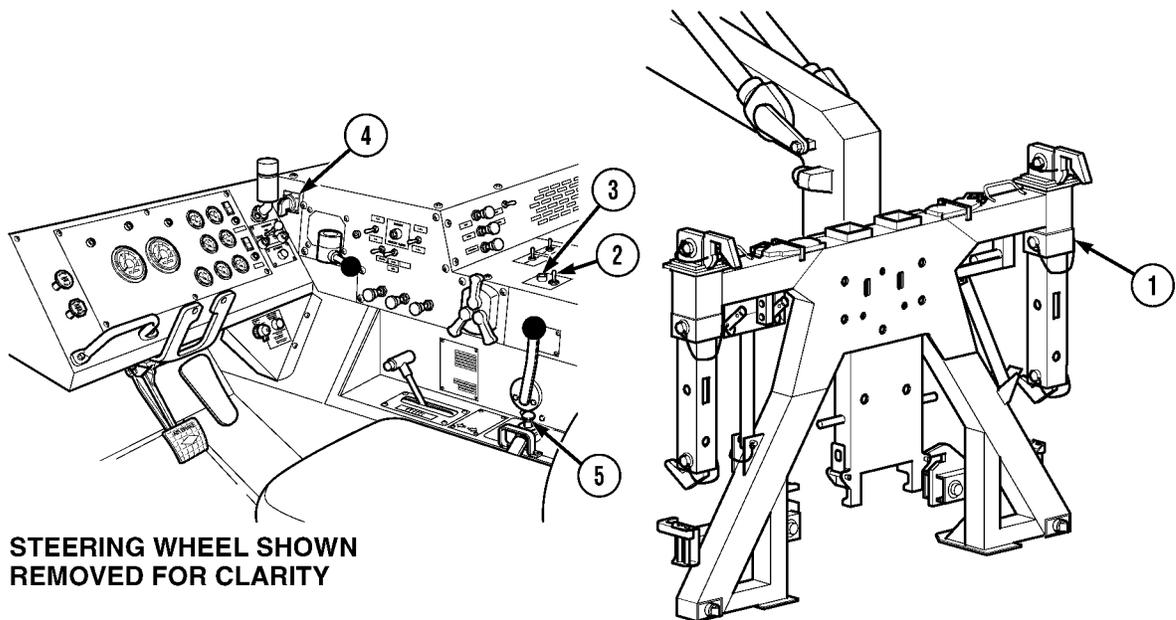

STEERING WHEEL SHOWN
REMOVED FOR CLARITY

CAUTION

Engine speed must be at idle before using hydraulic selector switch, or damage to equipment may result.

- (2) Start engine (TM 9-2320-279-10).
- (3) Put PTO ENGAGE switch (2) in ON position. Make sure indicator light (3) comes on.
- (4) Turn hydraulic selector switch (4) to AUTO.
- (5) Move joystick (5) to UNLOAD until front lift adapter (1) is approximately 12 in. (30 cm) from the ground.

Operating Instructions (Cont)

2-10.11 REMOVING AND INSTALLING FRONT LIFT ADAPTER FROM TRUCK (CONT).

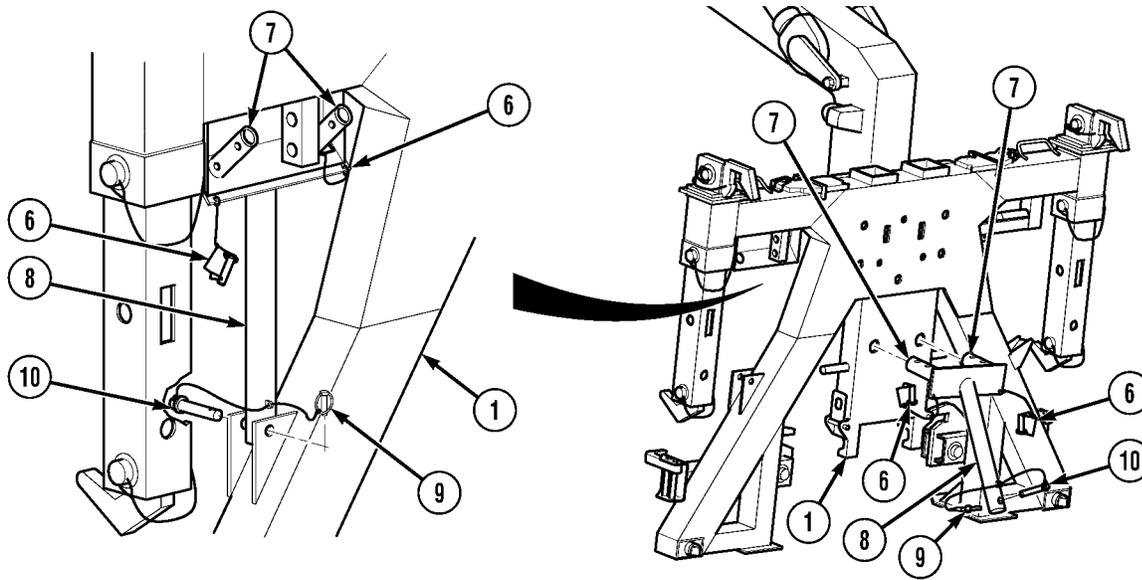

- (6) Shut off engine (TM 9-2320-279-10).
- (7) Remove two lock pins (6) from pins (7) and upper support leg (8).
- (8) Remove lock pin (9), pin (10), and upper support leg (8) from stowage bracket on front lift adapter (1).
- (9) Position two pins (7) on upper support leg (8) through two lower holes on front lift adapter (1).
- (10) Install two lock pins (6) in pins (7) on upper support leg (8) and front side of front lift adapter (1).

Operating Instructions (Cont)

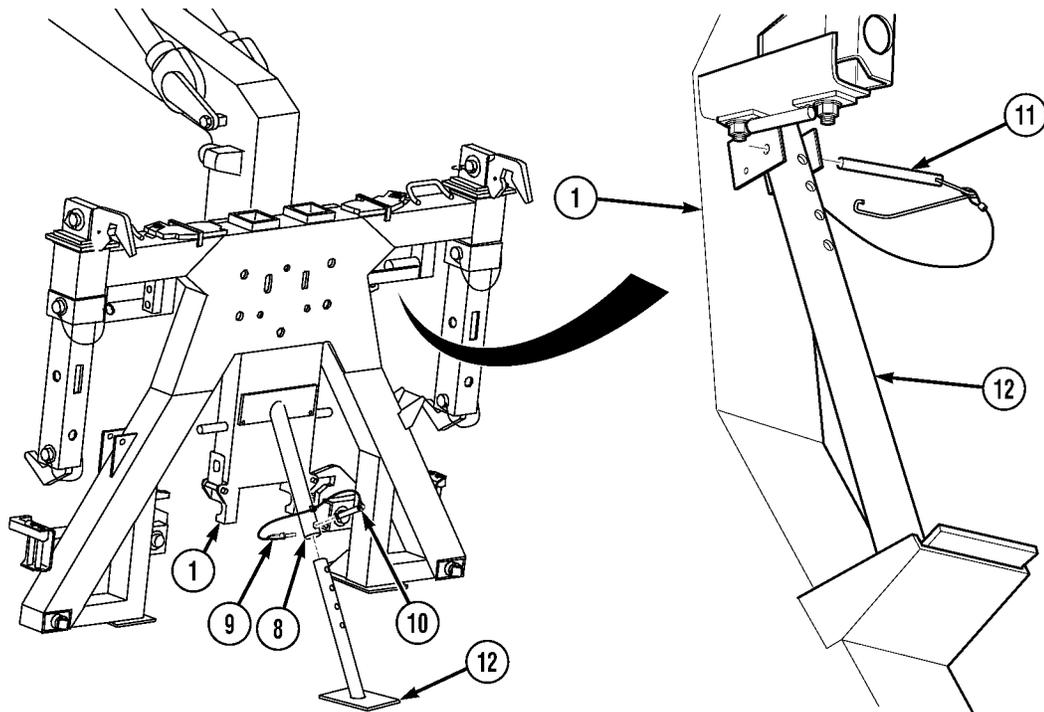

- (11) Remove lock pin (11) and lower support leg (12) from stowage bracket on front lift adapter (1).
- (12) Position lower support leg (12) in upper support leg (8).

NOTE

Other support leg pin hole positions may be used if ground is uneven.

- (13) Alined hole in upper support leg (8) with second hole from bottom on lower support leg (12) and install pin (10) and lock pin (9).
- (14) Install lock pin (11) in stowage bracket on front lift adapter (1).

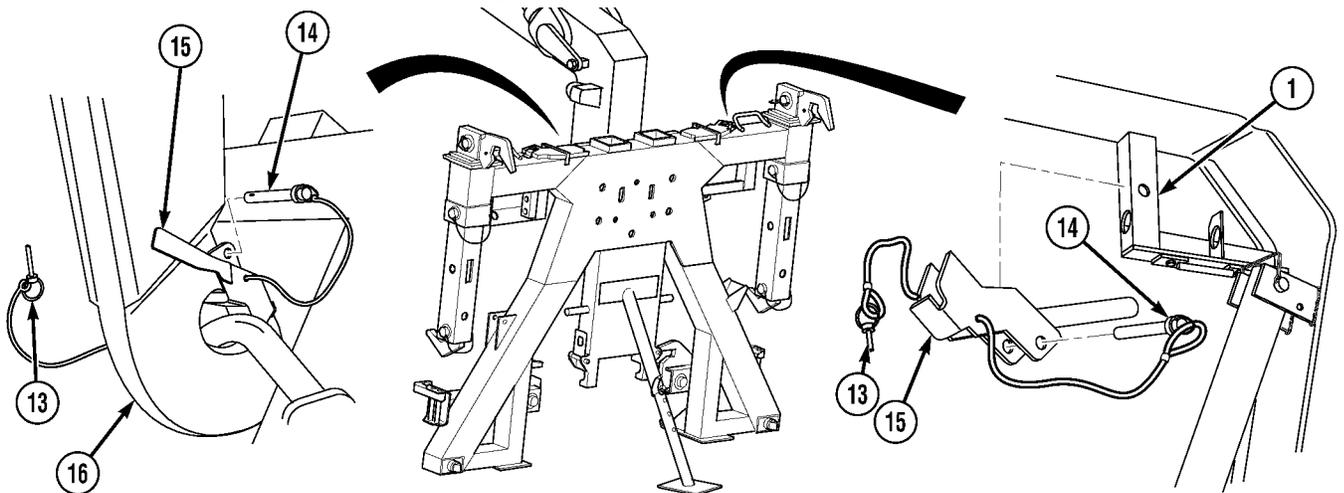

- (15) Remove lock pin (13), pin (14), and bail bar lock (15) from hook (16).
- (16) Install bail bar lock (15), pin (14), and lock pin (13) in stowage bracket on front lift adapter (1).

Operating Instructions (Cont)

2-10.11 REMOVING AND INSTALLING FRONT LIFT ADAPTER FROM TRUCK (CONT).

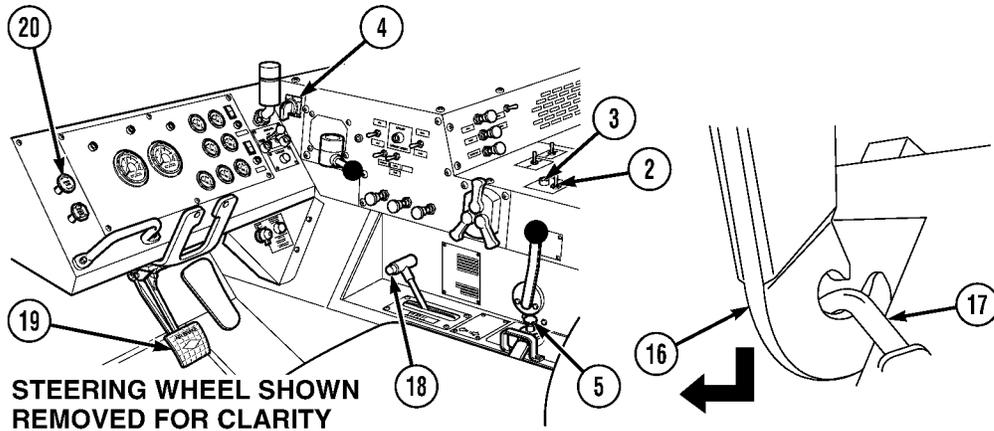

(17) Start engine (TM 9-2320-279-10).

NOTE

- To disengage LHS hook arm from front lift adapter hook, it may be necessary to cycle LHS to unload after driving ahead slightly.
- LHS will only operate when transmission range selector is in N (Neutral).
- If ground is soft, jacking plate from truck BII or similar item may be positioned under support leg pad to prevent front lift adapter from sinking in ground.

(18) Move joystick (5) to UNLOAD until LHS stops and hook (16) is below front lift adapter hook bar (17).

(19) Set transmission range selector (18) to D (Drive) and move truck ahead approximately 12 in. (30 cm).

(20) Apply service brake pedal (19), set transmission range selector (18) to N (Neutral), and pull out parking brake knob (20) to apply parking brake.

(21) Turn hydraulic selector switch (4) to OFF.

(22) Put PTO ENGAGE switch (2) in OFF position. Make sure indicator light (3) goes off.

(23) Shut off engine (TM 9-2320-279-10).

Operating Instructions (Cont)

b. Installing Front Lift Adapter onto Truck.

WARNING

- Front lift adapter weighs 1,600 lbs. (726 kg). Personnel must stay clear when installing or removing front lift adapter to LHS hook arm hook. Failure to comply may result in injury or death to personnel.
- Make sure front lift adapter is free of snow, ice, and mud when installing on LHS. Front lift adapter may be unbalanced and may cause injury or death to personnel.

NOTE

For detailed instructions on how to operate the LHS, refer to “LHS Controls and Indicators” (Para 2-1), “Picking Up a Flatrack in Auto Mode” (Para 2-9 b), and “Off-Loading Flatrack in Auto Mode” (Para 2-9 c).

- (1) Start engine (TM 9-2320-279-10).
- (2) Put PTO ENGAGE switch (1) in ON position. Make sure indicator light (2) comes on.

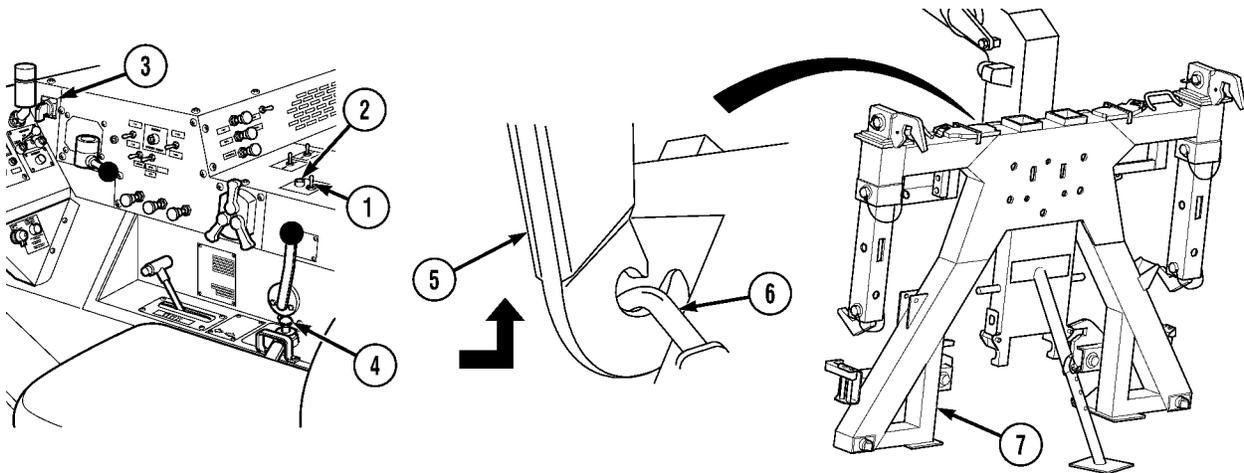

- (3) Turn hydraulic selector switch (3) to AUTO mode.
- (4) Move joystick (4) to LOAD until hook (5) is below front lift adapter hook bar (6).
- (5) Back truck up and engage hook bar (6) with hook (5).

CAUTION

Engine speed must be at idle before using hydraulic switch, or damage to equipment may result.

- (6) Move joystick (4) to LOAD and raise front lift adapter (7) approximately 12 in. (30 cm) off the ground.

Operating Instructions (Cont)

2-10.11 REMOVING AND INSTALLING FRONT LIFT ADAPTER FROM TRUCK (CONT).

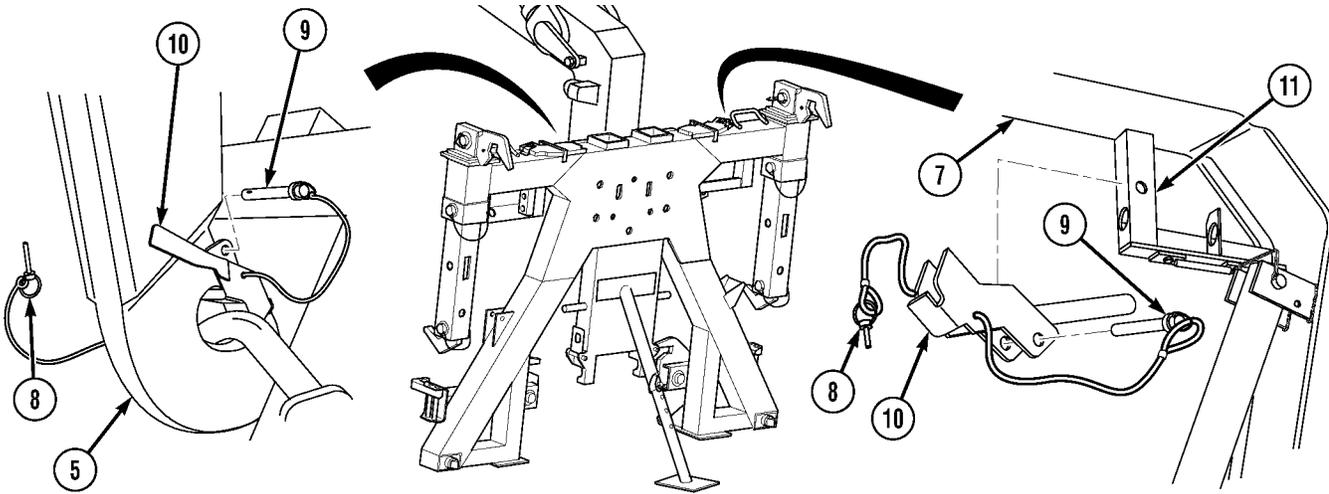

- (7) Shut off engine (TM 9-2320-279-10).
- (8) Remove lock pin (8), pin (9), and bail bar lock (10) from stowage bracket (11) on front lift adapter (7).
- (9) Install bail bar lock (10) on hook (5) with pin (9) and lock pin (8).

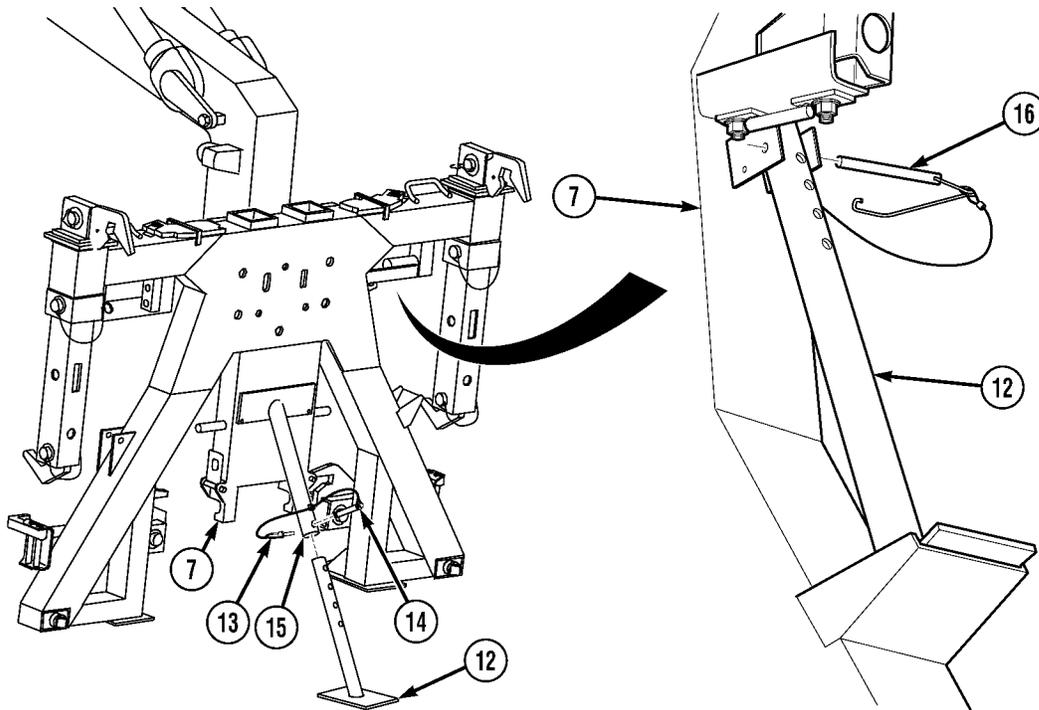

- (10) Support lower support leg (12) and remove lock pin (13) and pin (14).
- (11) Remove lower support leg (12) from upper support leg (15).
- (12) Remove lock pin (16) from stowage bracket front lift adapter (7).
- (13) Position lower support leg (12) in stowage bracket on front lift adapter (7) and install lock pin (16).

Operating Instructions (Cont)

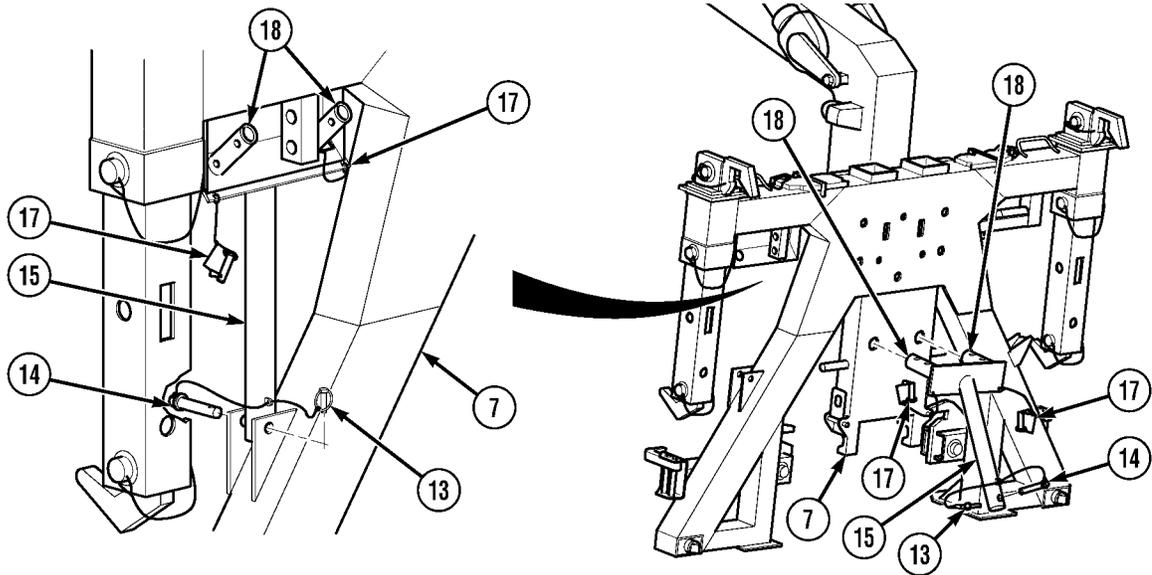

- (14) Support upper support leg (15) and remove two lock pins (17) from pins (18).
- (15) Remove upper support leg (15) from front lift adapter (7).
- (16) Position upper support leg (15) in stowage bracket on front lift adapter (7) and install two lock pins (17) on pins (18).
- (17) Install pin (14), lock pin (13), and upper support leg (15) to stowage bracket on front lift adapter (7).

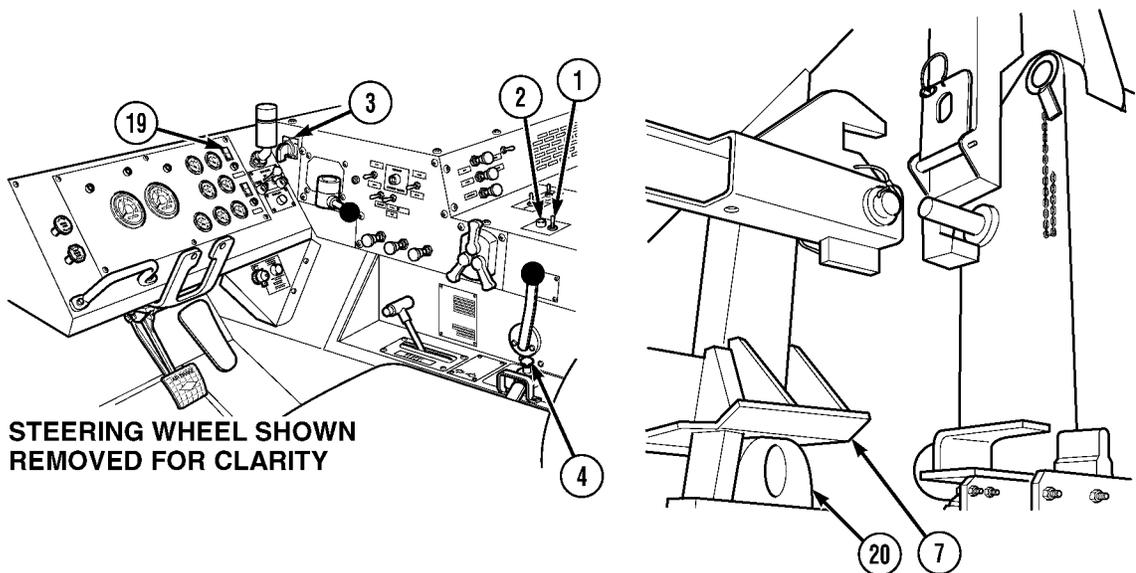

- (18) Start engine (TM 9-2320-279-10).
- (19) Move joystick (4) to LOAD until LHS NO TRANS light (19) goes out and front lift adapter (7) is positioned on bumper supports (20).
- (20) Turn hydraulic selector switch (3) to OFF.
- (21) Put PTO ENGAGE switch (1) in OFF position. Make sure indicator light (2) goes off.

Operating Instructions (Cont)

2-10.12 SIMPLIFIED CONTAINER HANDLING UNIT (CHU) OPERATION.

WARNING

These simplified procedures are to be used only as a guide. Full procedures for operation of the Container Handling Unit (CHU) are to be followed as authored in (Para 2-10.1 through 2-10.11).

FOLD

LOADING Container 82 in. (208 cm) or higher (Para 2-10.2), 72 in. (183 cm) (Para 2-10.3), 51 in. (130 cm) (Para 2-10.4), 48 in. (122 cm) (Para 2-10.5). (CHECKS: Lower Locks unlocked, FLA configured for size container, bumper supports rearward, slider and transit locks ready.)

- (1) Verify that FLA is not locked to HA and truck is in container mode.
- (2) Back up to container to within 9-ft. (3 m) align truck with container.
- (3) Cycle LHS to unload until FLA upper hooks are visible just below top edge of container.
- (4) Make sure FLA configured for container, slide arms pinned if needed, lower container locks unlocked, and correct hook in slide arm.
- (5) Back truck up until FLA contacts container. Alining hooks with container corner openings.
- (6) Cycle LHS to load until hooks are above container.
- (7) Continue backing up truck until hooks are positioned over container.
- (8) Cycle LHS to unload to engage hooks into container top corners.
- (9) Continue to cycle LHS until lower locks are low enough to engage container bottom corners.
- (10) Back up truck to engage FLA lower locks in container corners. Steer truck to align lower locks with container.
- (11) CHECK: Upper hook thumb engaged, lower locks flush, sliders positioned straight ahead, and clean of debris.
- (12) Lock lower locks to container; handle straight up, lock plate over handle and handnut.
- (13) Lock other side.
- (14) Cycle LHS to LOAD to lift container onto truck.
- (15) Observe clearance between container and slider guides on both sides to make sure container is centered during loading.

- (16) Fully load container until LHS NOT TRANSIT light goes out.
- (17) Pin transit locks in locked position, RH and LH.
- (18) Verify container is properly loaded onto the truck.

UNLOADING Container 82 in. (208 cm) or higher (Para 2-10.2), 72 in. (183 cm) (Para 2-10.3), 51 in. (130 cm) (Para 2-10.4), 48 in. (122 cm) (Para 2-10.5).

- (1) Verify sufficient room and ground conditions.
- (2) Disengage transit locks, RH and LH and lock transit locks in ready position.
- (3) Cycle LHS to UNLOAD container.
- (4) Unlock lower container locks; handle inward, handnut tightened up, lock plate over handnut.
- (5) Unlock other side.
- (6) Drive forward approximately 6 in. (15 cm), to disengage lower locks.
- (7) Cycle LHS to load to disengage upper hooks from container.
- (8) Continue to cycle LHS fully to LOAD until LHS NO TRANSIT light goes out and CHU is in ready mode.

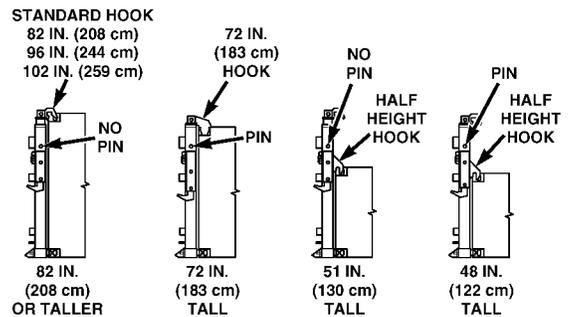

FOLD

Operating Instructions (Cont)

2-11. CONFIGURING FOR AIR/SEA TRANSPORT.

a. Before.

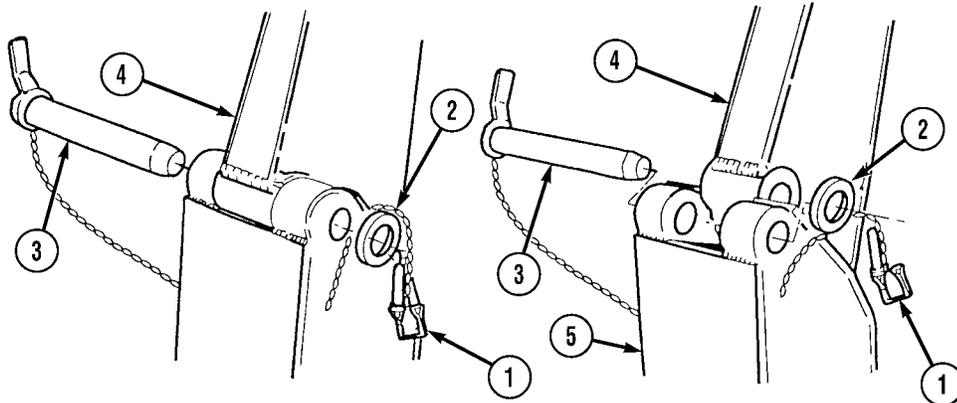
**WARNING**

Lift hook weighs 200 lbs. (91 kg). Attach suitable lifting device prior to removal or installation to prevent possible injury to personnel.

- (1) Remove safety pin (1), washer (2), and LHS hook arm pin (3) from hook (4).
- (2) Position hook (4) toward rear of truck and reinsert hook arm pin (3), washer (2), and safety pin (1) through main beam (5) only.

Operating Instructions (Cont)

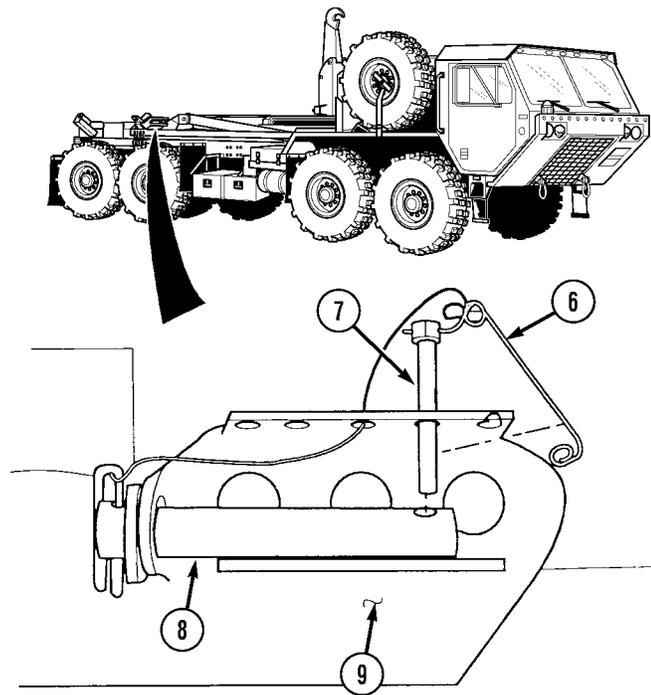

NOTE

- Both hitch pins are installed the same way. Right side is shown.
- Do steps (3) through (9) for truck with flatrack.

- (3) Remove safety pin (6) from lock pin (7).
- (4) Remove lock pin (7) from hitch pin (8).
- (5) Remove hitch pin (8) from bracket (9).

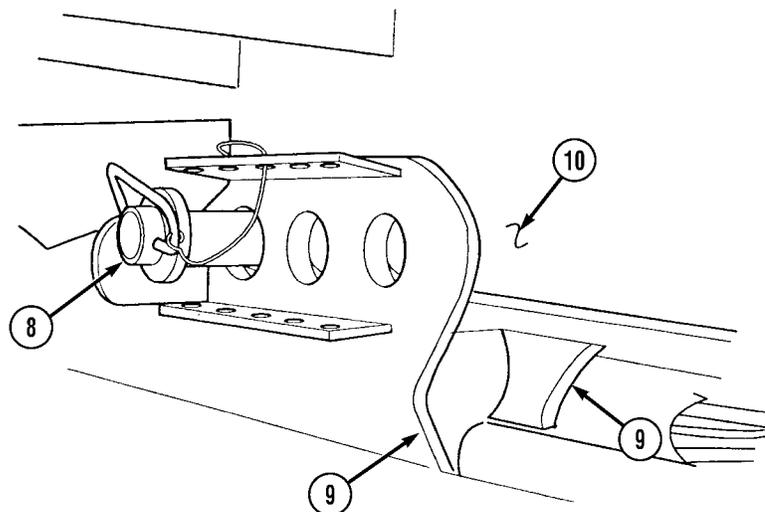

- (6) Install hitch pin (8) through bracket (9) and flatrack main rail (10).

Operating Instructions (Cont)

2-11. CONFIGURING FOR AIR/SEA TRANSPORT (CONT).

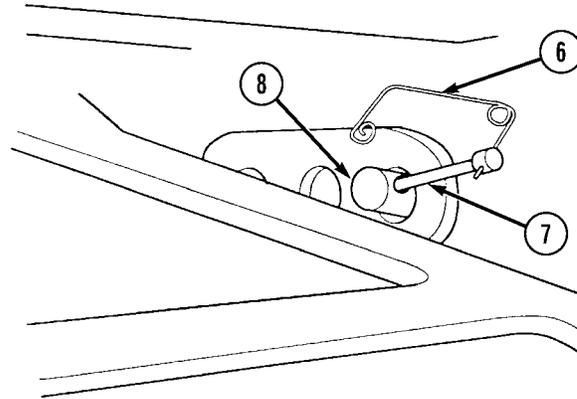

- (7) Install lock pin (7) in hitch pin (8).
- (8) Install safety pin (6) in lock pin (7).
- (9) Repeat steps (3) through (8) for left side.

a.1 Before with CHU.

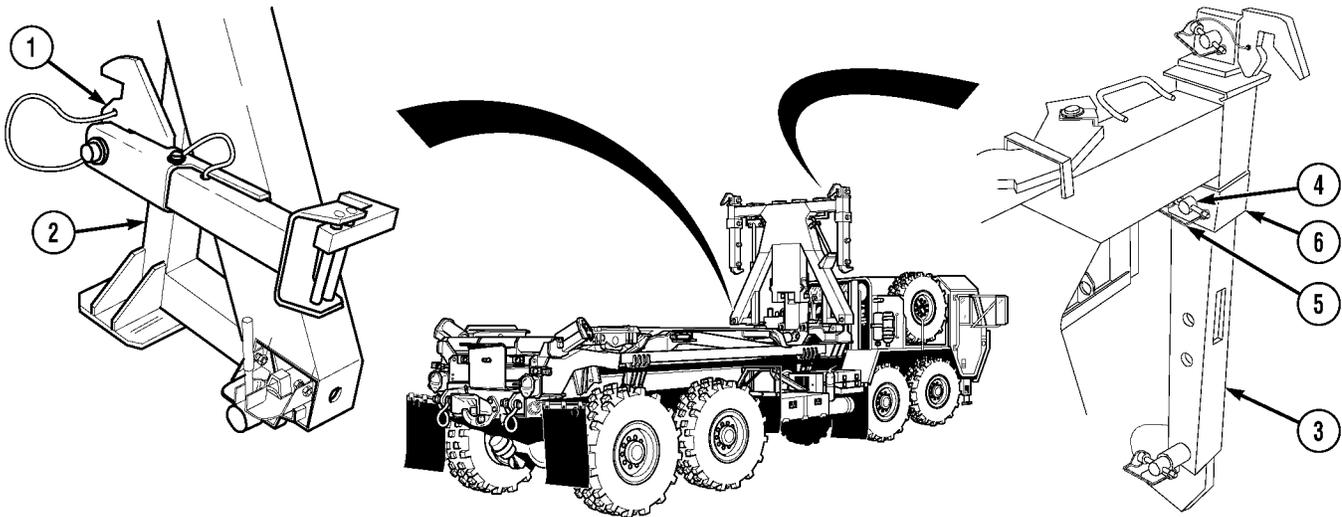

WARNING

Front lift adapter weighs 1600 lbs. (726 kg). Personnel must stay clear when installing or removing lifting frame to LHS hook arm hook. Failure to comply may result in injury or death to personnel.

- (1) Make sure two slide arm lower front hooks (1) are in stowed location on front lift adapter (2).
- (2) Make sure slide arms (3) have pins (4) and lock pins (5) installed in front lift adapter upper arms (6).

Operating Instructions (Cont)

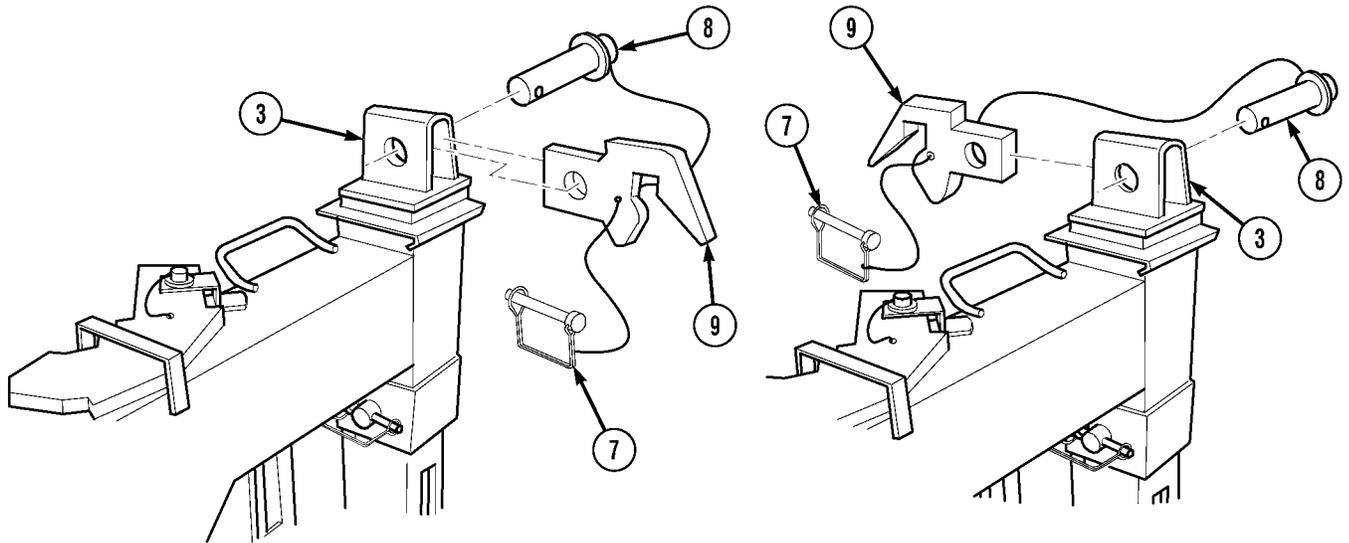

NOTE

There are two slide arms. Right side shown.

- (3) Remove lock pin (7), pin (8), and slide arm upper front hook (9) from slide arm (3).

NOTE

Slide arm upper front hooks should face away from tires when in transport mode.

- (4) Rotate slide arm upper front hook (9) 180 degrees and install in slide arm (3) with pin (8) and lock pin (7).

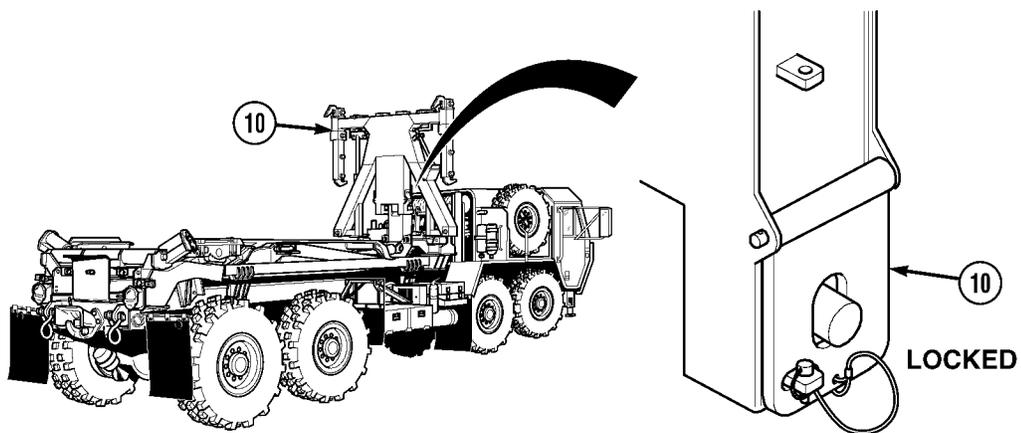

- (5) Make sure front lift adapter (10) is installed on truck (Para 2-10.11).
- (6) Make sure front lift adapter (10) is in locked position (Para 2-10.6).

Operating Instructions (Cont)

2-11. CONFIGURING FOR AIR/SEA TRANSPORT (CONT).

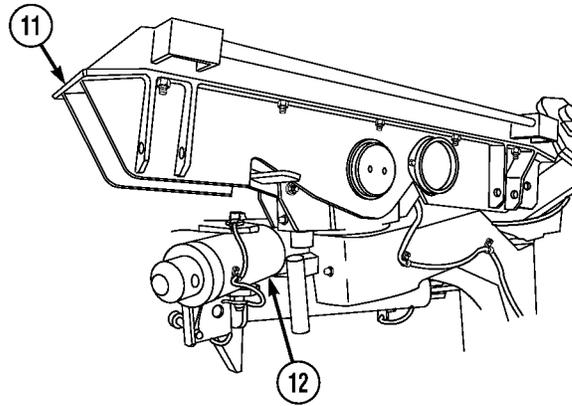

- (7) Make sure sliders (11) and struts (12) are in stowed position, refer to (Para 2-10.1).

WARNING

- Check for overhead power lines or other obstructions before attempting LHS operations. LHS reaches a height of 17 ft. 2 in. (5.23 m). Injury or death could result if LHS contacts power lines.
- Use caution when working around front lift adapter. Front lift adapter may swing unexpectedly when not attached to container. Failure to comply may result in injury or death to personnel.

CAUTION

Engine speed must be at idle before using hydraulic selector switch, or damage to equipment may result.

NOTE

For detailed instructions on how to operate the LHS, refer to “LHS Controls and Indicators” (Para 2-1), “Picking Up a Flatrack in Auto Mode” (Para 2-9 b), and “Off-Loading Flatrack in Auto Mode” (Para 2-9 c).

- (8) Start engine (TM 9-2320-279-10).

Operating Instructions (Cont)

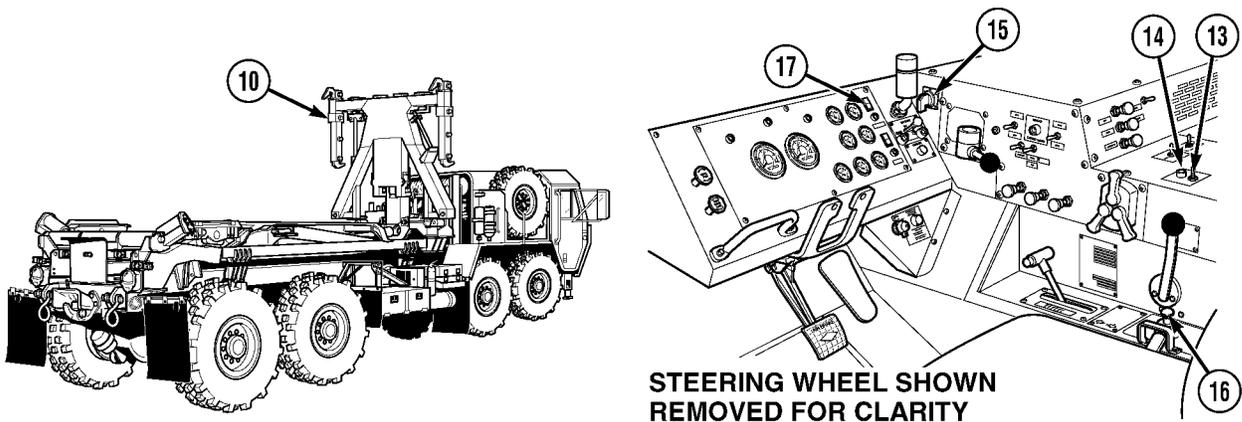

WARNING

- Do not allow front lift adapter to contact the ground. Failure to comply may result in the front lift adapter disengaging the LHS hook arm, which could result in damage to equipment and injury or death to personnel.
- Front lift adapter and hook weigh 1,750 lbs. (794 kg). Attach suitable lifting device prior to removal or installation to prevent possible injury to personal.

- (9) Put PTO ENGAGE switch (13) in ON position. Make sure indicator light (14) comes on.
- (10) Turn hydraulic selector switch (15) to AUTO.
- (11) Move joystick (16) to UNLOAD. Hook arm will raise and begin to move rearward. LHS NO TRANS lamp (17) will illuminate to indicate hook arm is up and load lock has been cleared.

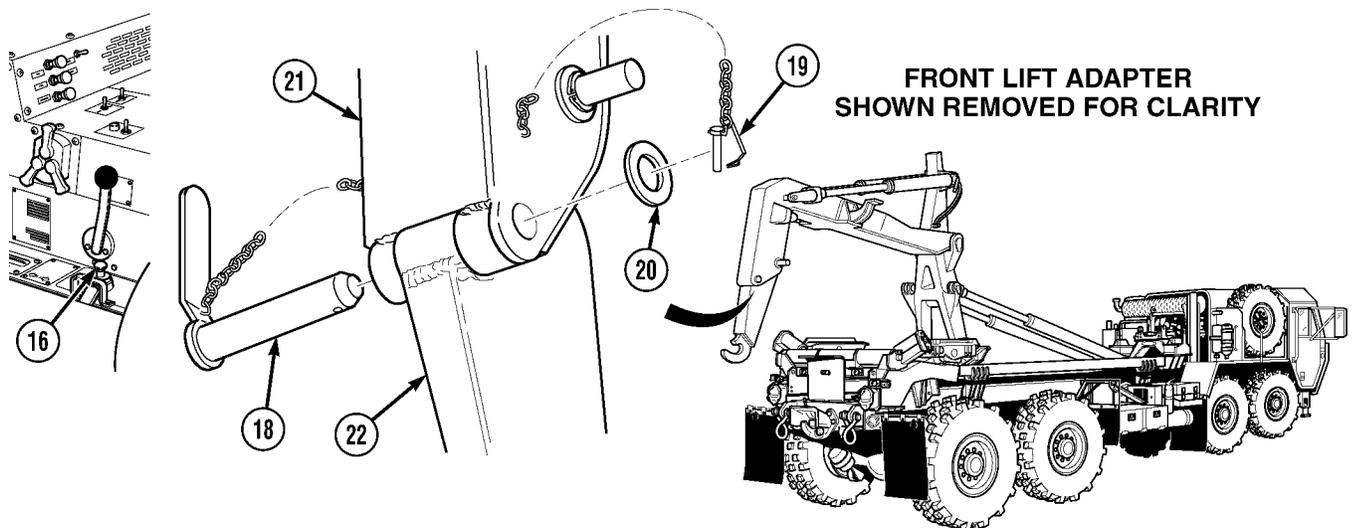

NOTE

The position that LHS and front lift adapter need to be in to access the hook arm retaining pin will vary, depending on the height of the operator.

- (12) Continue to hold joystick (16) in UNLOAD position until LHS hook arm retaining pin (18) can be removed. FLA 15 to 16 in. (381 to 406 mm) from ground.
- (13) Release joystick (16).
- (14) Remove lock pin (19), washer (20), and LHS hook arm retaining pin (18) from LHS hook arm (21) and hook (22).

Operating Instructions (Cont)

2-11. CONFIGURING FOR AIR/SEA TRANSPORT (CONT).

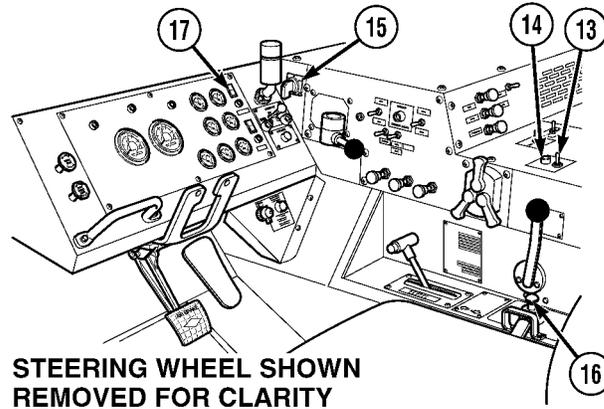

- (15) Move joystick (16) to LOAD until LHS is fully stowed and LHS NO TRANS lamp (17) goes out.
- (16) Release joystick (16).

CAUTION

Engine speed must be at idle before using hydraulic selector switch, or damage to equipment may result.

- (17) Turn hydraulic selector switch (15) to OFF.
- (18) Put PTO ENGAGE switch (13) in OFF position. Make sure indicator light (14) goes off.

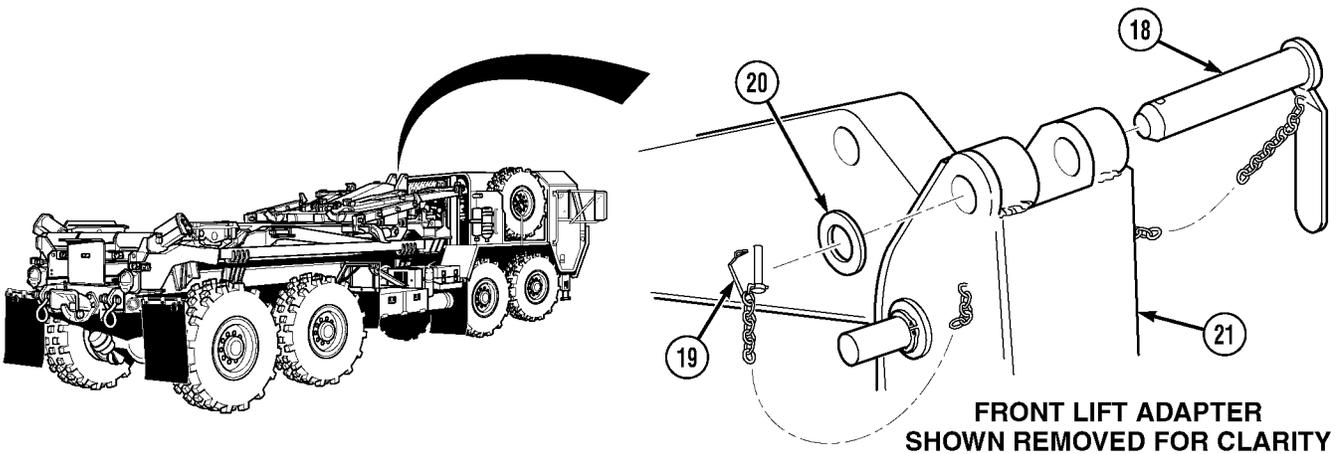

- (19) Install LHS hook arm retaining pin (18), washer (20), and lock pin (19) in LHS hook arm (21).

Operating Instructions (Cont)

b. After.

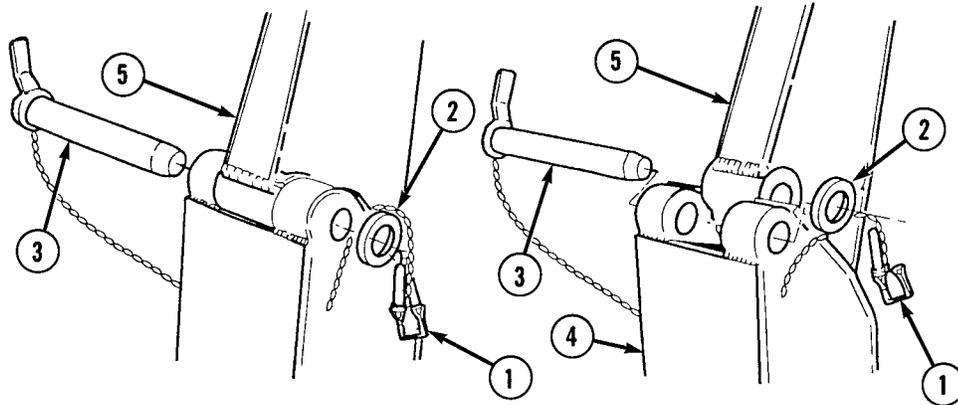
**WARNING**

Lift hook weighs 200 lbs. (91 kg). Attach suitable lifting device prior to removal or installation to prevent possible injury to personnel.

- (1) Remove safety pin (1), washer (2), and pin (3) from main beam (4).
- (2) Position hook toward front of truck and install pin (3) through hook arm (5) and main beam (4) with washer (2) and safety pin (1).

Operating Instructions (Cont)

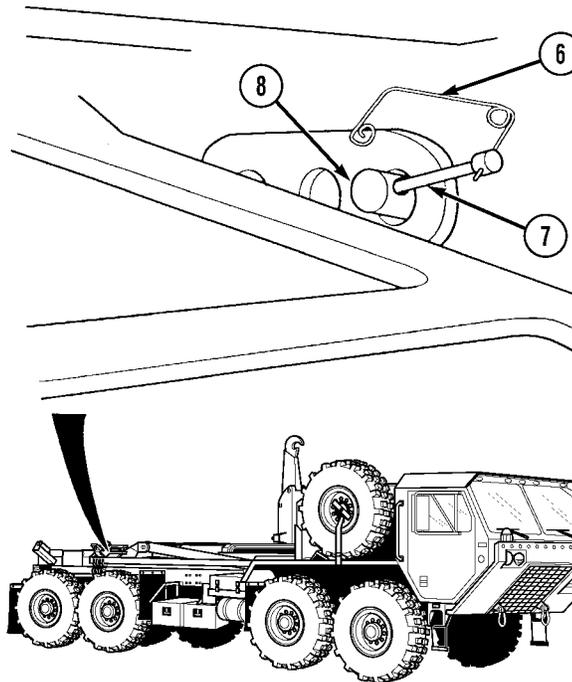

NOTE

- Both hitch pins are removed the same way. Right side is shown.
- Do steps (3) through (9) for truck with flatrack.

- (3) Remove safety pin (6) from lock pin (7).
- (4) Remove lock pin (7) from hitch pin (8).

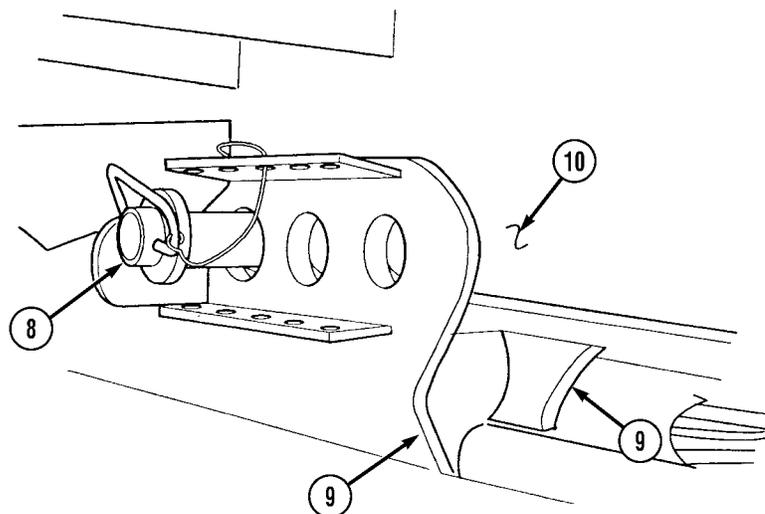

- (5) Remove hitch pin (8) from bracket (9) and flatrack main rail (10).

Operating Instructions (Cont)

2-11. CONFIGURING FOR AIR/SEA TRANSPORT (CONT).

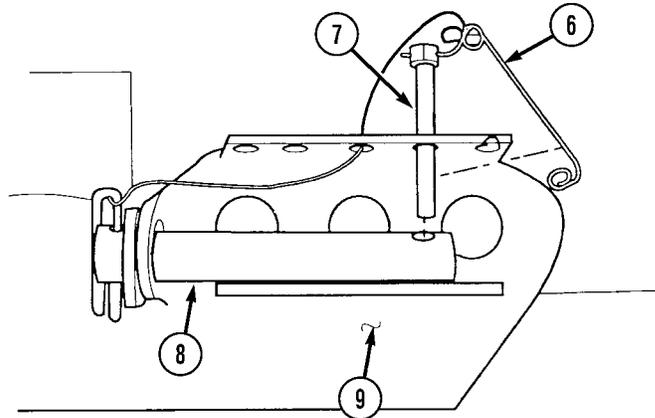

- (6) Install hitch pin (8) on bracket (9).
- (7) Install lock pin (7) in hitch pin (8).
- (8) Install safety pin (6) in lock pin (7).
- (9) Repeat steps (3) through (8) for left side.

c. After with CHU.

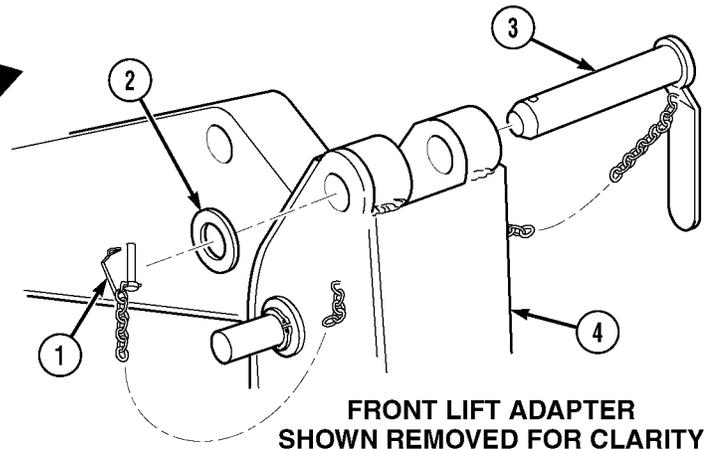
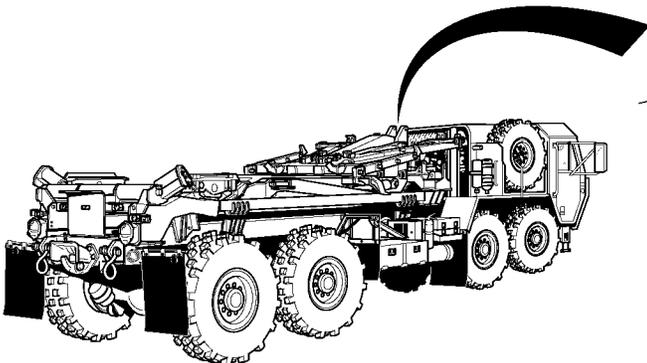

**FRONT LIFT ADAPTER
SHOWN REMOVED FOR CLARITY**

WARNING

- Use caution when working around lifting frame. Lifting frame may swing unexpectedly when not attached to container. Failure to comply may result in injury or death to personnel.
- Lifting frame and hook weigh 1700 lbs. (771 kg). Attach suitable lifting device prior to removal or installation to prevent possible injury to personal.

- (1) Remove lock pin (1), washer (2), and LHS hook arm retaining pin (3) from LHS hook arm (4).

Operating Instructions (Cont)

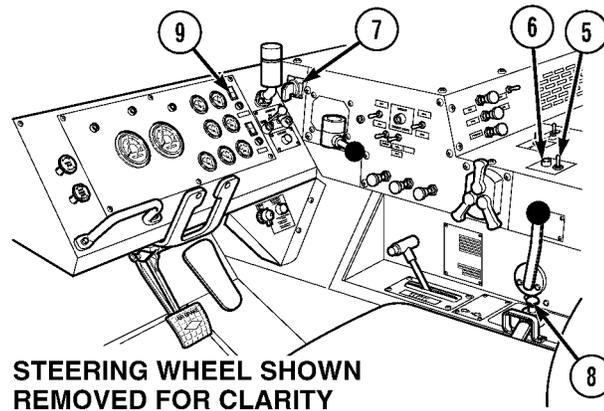
**CAUTION**

Engine speed must be at idle before using hydraulic selector switch, or damage to equipment may result.

- (2) Start engine (TM 9-2320-279-10).
- (3) Put PTO ENGAGE switch (5) in ON position. Make sure indicator light (6) comes on.
- (4) Turn hydraulic selector switch (7) to AUTO.
- (5) Move joystick (8) to UNLOAD. Hook arm will raise and begin to move rearward. LHS NO TRANS lamp (9) will illuminate to indicate hook arm is up and load lock has been cleared.

Operating Instructions (Cont)

2-11. CONFIGURING FOR AIR/SEA TRANSPORT (CONT).

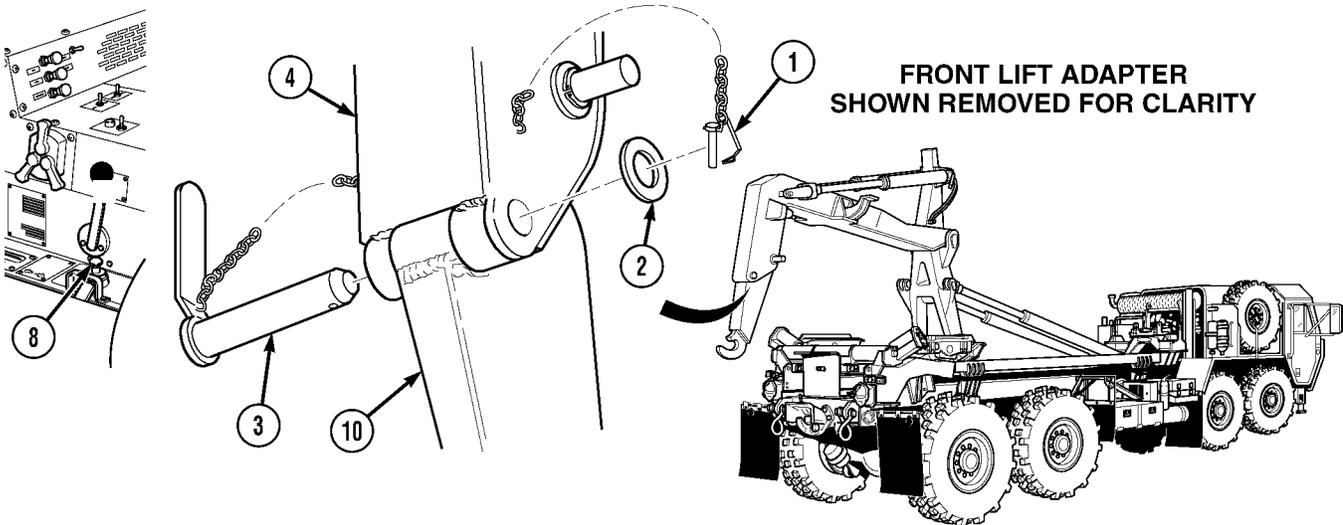

NOTE

The position that LHS and lifting frame need to be in to access the hook arm retaining pin will vary depending on the height of the operator.

- (6) Continue to hold joystick (8) to UNLOAD position until LHS hook arm retaining pin (3) can be installed. FLA 15 to 16 in. (381 to 406 mm) from ground.
- (7) Release joystick (8).
- (8) Install LHS hook arm retaining pin (3), washer (2), and lock pin (1) in LHS hook arm (4) and hook (10).

Operating Instructions (Cont)

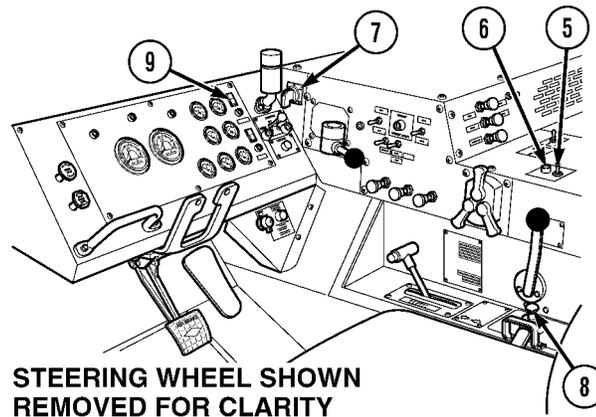

- (9) Move joystick (8) to LOAD until LHS is fully stowed and LHS NO TRANS lamp (9) goes out.
- (10) Release joystick (8).

CAUTION

Engine speed must be at idle before using hydraulic selector switch, or damage to equipment may result.

- (11) Turn hydraulic selector switch (7) to OFF.
- (12) Put PTO ENGAGE switch (5) in OFF position. Make sure indicator light (6) goes off.

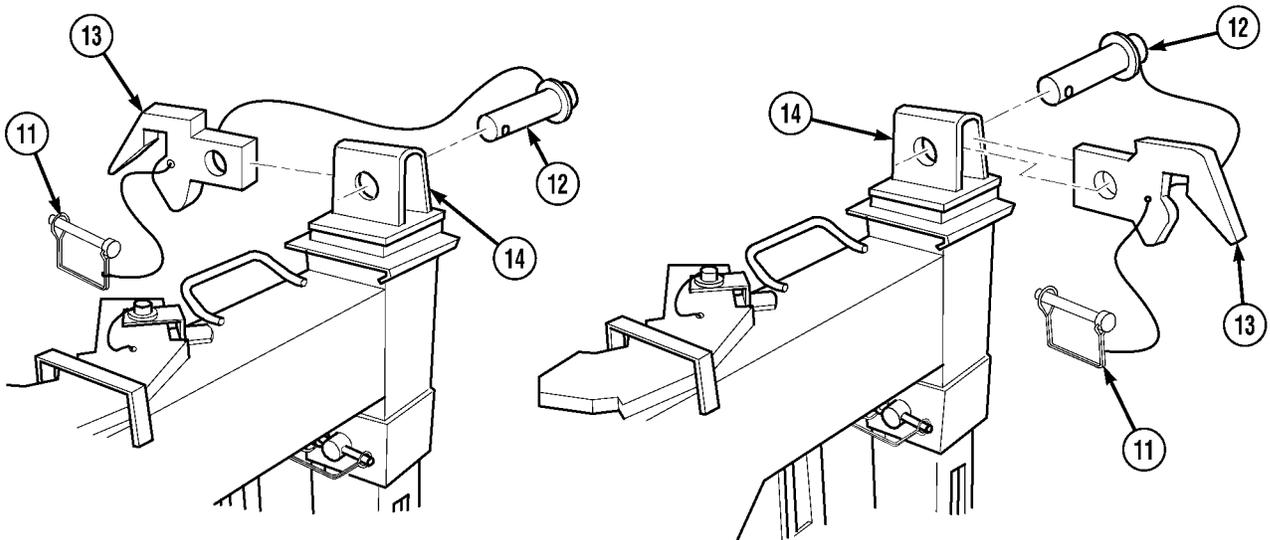

NOTE

There are two slide arms. Right side shown.

- (13) Remove lock pin (11), pin (12), and slide arm upper front hook (13) from slide arm (14).

NOTE

Slide arm upper front hooks should face toward rear of truck.

- (14) Rotate slide arm upper front hook (13) 180 degrees and install in slide arm (14) with pin (12) and lock pin (11).

Operating Instructions (Cont)

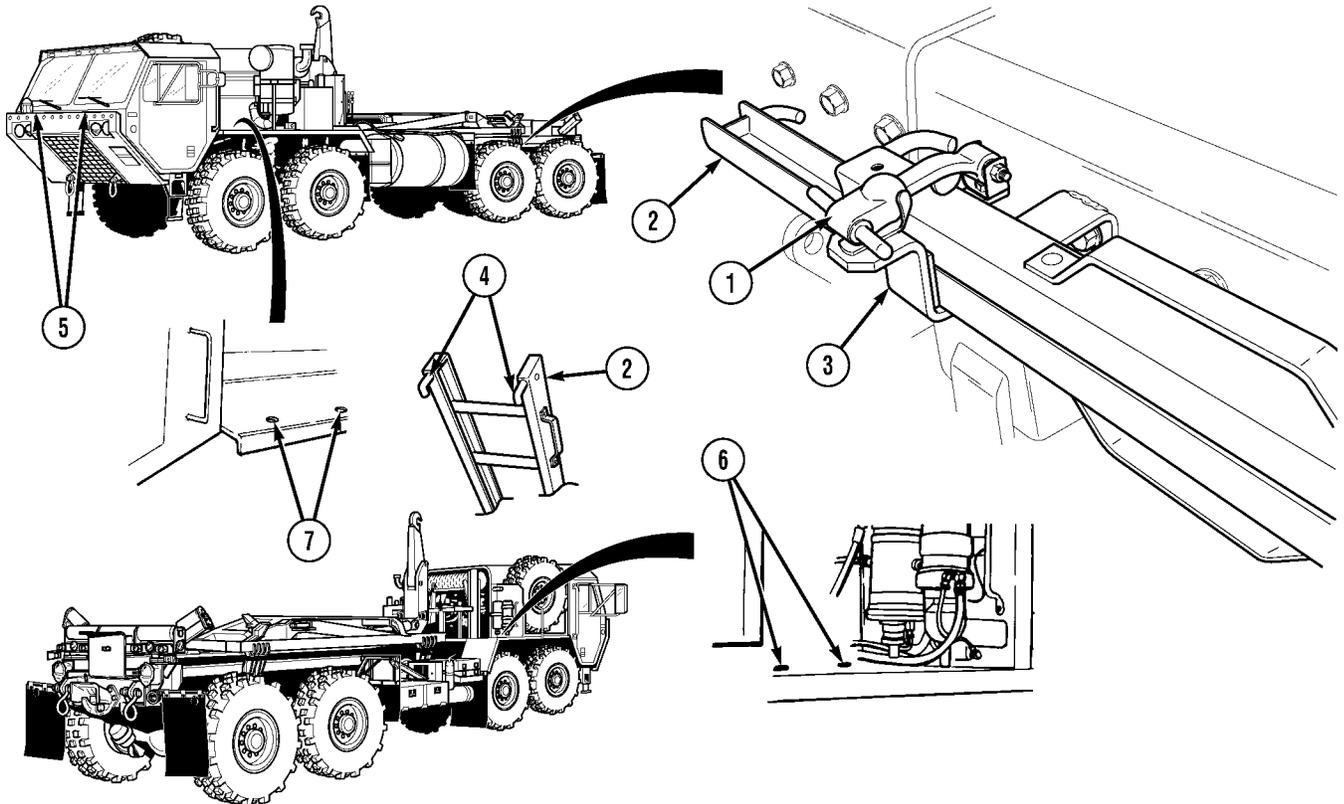
2-12. USE ACCESS LADDER.*a. Install Access Ladder.*

- (1) Pull rubber hooks (1) out and up.
- (2) Remove ladder (2) from ladder brackets (3).
- (3) Open ladder (2).
- (4) Install access ladder hooks (4) in front skid plate holes (5), right front fender holes (6), or left front fender holes (7), as required.

Operating Instructions (Cont)

2-12. USE ACCESS LADDER (CONT).

b. Stow Access Ladder.

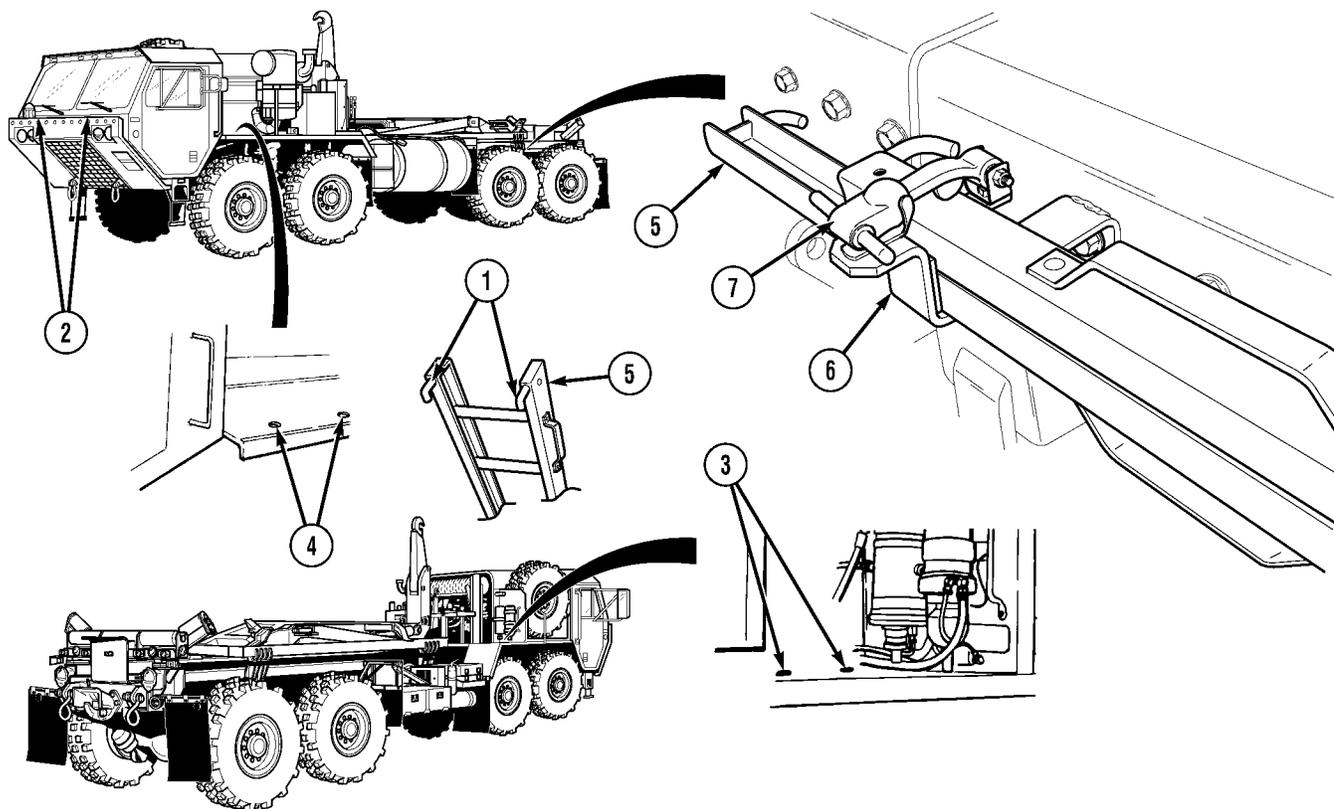

- (1) Remove access ladder hooks (1) from front skid plate holes (2), right front fender holes (3), or left front fender holes (4).
- (2) Close ladder (5).
- (3) Install ladder (5) in ladder brackets (6).
- (4) Connect rubber hooks (7).

Operating Instructions (Cont)

Section IV. Operating Instructions, Operations under Unusual Conditions

**2-13. OPERATE VEHICLE IN EXTREME COLD ENVIRONMENT
(-26°F [-32°C] TO -50°F [-46°C]).**

Before operating Load Handling System (LHS), perform warm-up as follows:

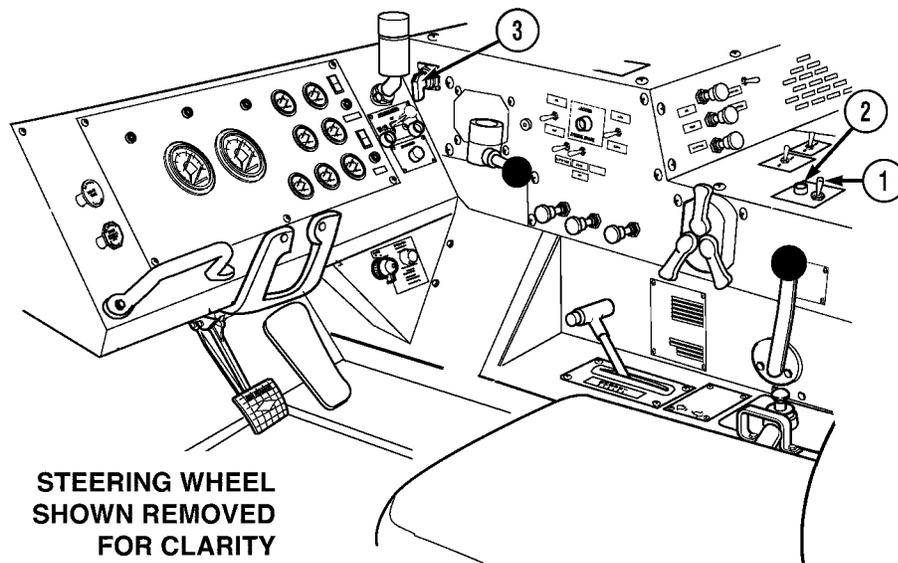

- (1) With engine running at idle, put PTO ENGAGE switch (1) in ON position. Make sure indicator light (2) is on.
- (2) Select AUTO position on the hydraulic selector switch (3). Allow pump to operate for five minutes at idle. LHS is then ready for operation at idle.
- (3) Cycle at idle the LHS (Para 2-9).
- (4) After one complete cycle at idle, the LHS is ready for normal operation.

Operating Instructions (Cont)

2-14. EMERGENCY PROCEDURES.

a. LHS Auxiliary Slave Hydraulics Operation (Auxiliary [Slave] Hydraulics).

CAUTION

If LHS system on disabled truck is not in fully stowed position (transport position), remove hydraulic tank cap from operable truck prior to starting the task to allow excess hydraulic oil to drain. Failure to comply may result in damage to hydraulic tank or hydraulic system.

NOTE

- This procedure can only be used if there are no leaks or breaks in the hydraulic system.
- This procedure is used to remove the load from a truck with a failed hydraulic pump or other failure which prevents operation of the hydraulic system.
- Each truck is equipped with one hydraulic slave hose. Two hoses (one from each truck) are required to perform slave hydraulics. Remove hoses from stowage boxes of trucks.

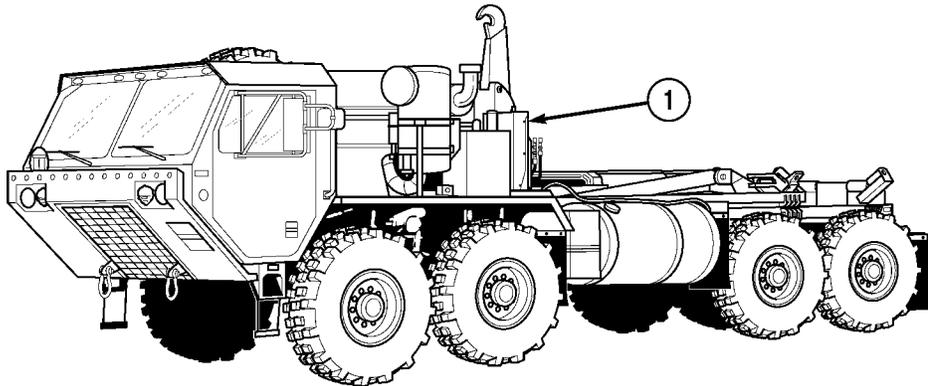

- (1) Move trucks into position so LHS control box (1) on both trucks are side by side.
- (2) Park both trucks (TM 9-2320-279-10).
- (3) Shut off engines (TM 9-2320-279-10).

Operating Instructions (Cont)

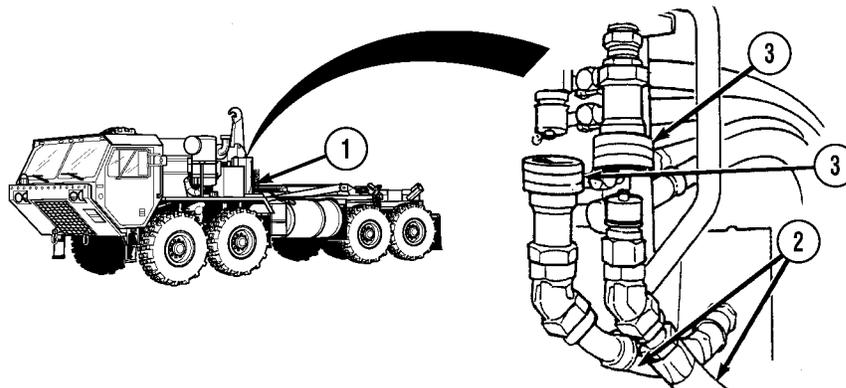

WARNING

Hydraulic fluid is under great pressure. Engines on both trucks must be shut off while disconnecting hydraulic lines, steps (4) through (8). Failure to do so could cause serious injury or death to personnel.

CAUTION

To prevent hydraulic contamination, keep hydraulic quick disconnects clean or damage to hydraulic system may result.

NOTE

Quick disconnects are located on the back of the LHS box.

- (4) Disconnect hydraulic lines (2) on both trucks at quick disconnects (3) located on the back of the LHS control box (1).

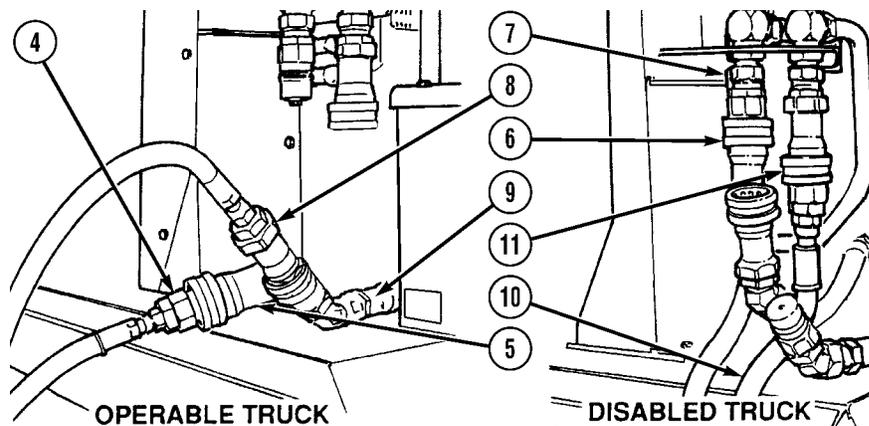

- (5) Using first slave hose (4), connect male end of slave hose (4) to female end of supply hose (5) on operable truck.
- (6) Connect female end of first slave hose (6) to male end of supply quick disconnect (7) located on back of LHS control box on disabled truck.
- (7) Using second slave hose, connect female end of slave hose (8) to male end of return hose (9) on operable truck.
- (8) Connect male end of second slave hose (10) to female return quick disconnect (11) located on back of LHS control box on disabled truck.

Operating Instructions (Cont)

2-14. EMERGENCY PROCEDURES (CONT).

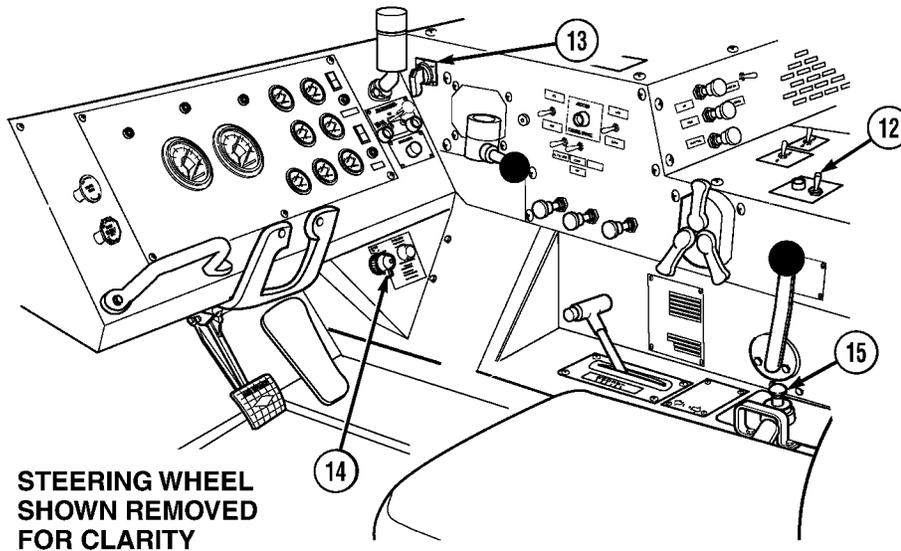

CAUTION

Engine speed must be at idle before using hydraulic selector switch, or damage to equipment may result.

- (9) Start engine on operable truck.

NOTE

Steps (10) and (11) apply to operable truck only.

- (10) Put PTO ENGAGE switch (12) in ON position. Make sure indicator light (13) comes on.
- (11) Turn hydraulic selector switch (14) to AUTO position.
- (12) If disabled truck has a failure in the hydraulic system, but not the electrical system, go to step (13). If both systems have failed, go to step (14).

CAUTION

Engine speed must be at idle before using hydraulic selector switch, or damage to equipment may result.

- (13) On disabled truck, turn ignition switch (15) to ON and turn hydraulic selector switch (14) to AUTO position. Operate joystick (16) to return LHS to the stowed position. Go to step (16).

Operating Instructions (Cont)

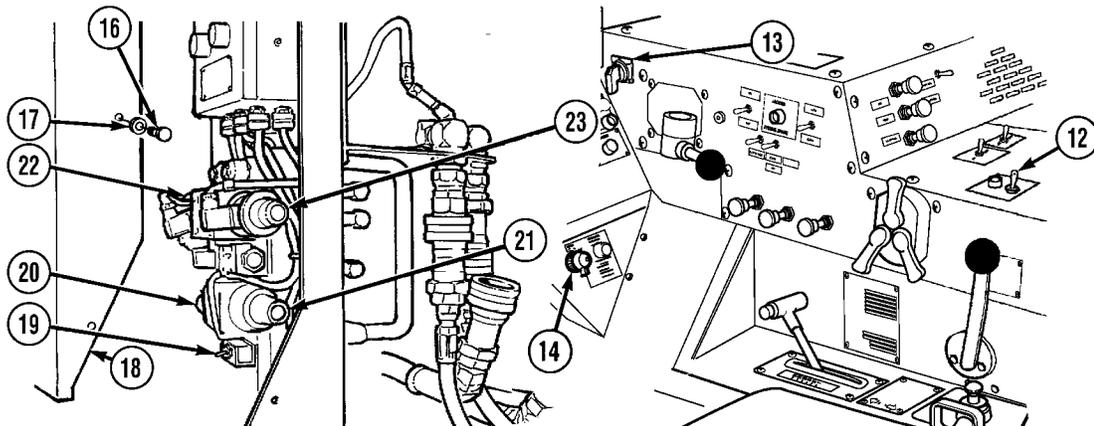
**NOTE**

Only remove center screw on engine side of LHS control box cover.

- (14) On disabled truck, remove four screws (17), lockwashers (18), and LHS control box cover (19).

NOTE

Button may be stiff and hard to push in.

- (15) Press and hold free flow valve override button (20). Press one or more of the following buttons to return LHS to the stowed position: hook arm UP (21), hook arm DOWN (22), main frame UP (23), main frame DOWN (24).

CAUTION

Engine speed must be at idle before using hydraulic selector switch, or damage to equipment may result.

- (16) On both trucks, turn hydraulic selector switch (14) to OFF position.
 (17) Put PTO ENGAGE switch (12) in OFF position on operable truck. Make sure indicator light (13) goes off.
 (18) Shut down engine on operable trucks.
 (19) On disabled truck, turn ignition switch (15) to OFF.

Operating Instructions (Cont)

2-14. EMERGENCY PROCEDURES (CONT).

WARNING

Hydraulic fluid is under great pressure. Engines on both trucks must be shut off while disconnecting hydraulic lines, steps (20) through (24). Failure to do so could cause serious injury or death to personnel.

CAUTION

To prevent hydraulic contamination, keep hydraulic quick disconnects clean or damage to hydraulic system may result.

NOTE

Quick disconnects are located on the back of the LHS box.

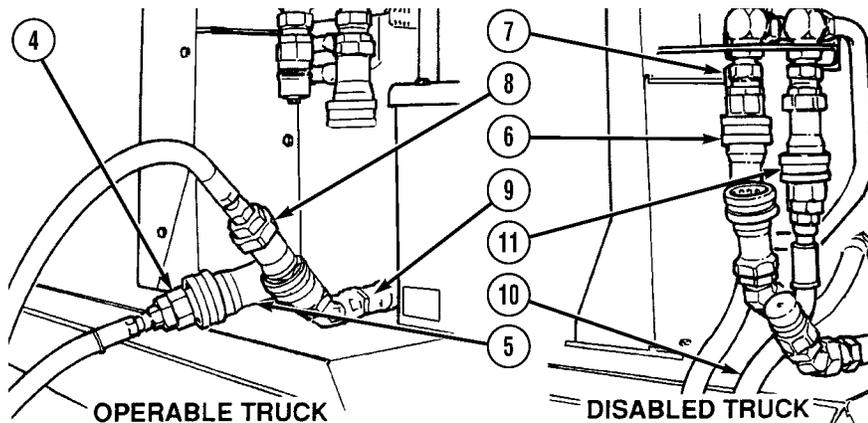

- (20) Disconnect first slave hose, male end of slave hose (4) from female end of supply hose (5) on operable truck.
- (21) Disconnect female end of first slave hose (6) from male end of supply quick disconnect (7) located on back of LHS control box on disabled truck.
- (22) Disconnect second slave hose, female end of slave hose (8) from male end of return hose (9) on operable truck.
- (23) Disconnect male end of second slave hose (10) from female return quick disconnect (11) located on back of LHS control box on disabled truck.

Operating Instructions (Cont)

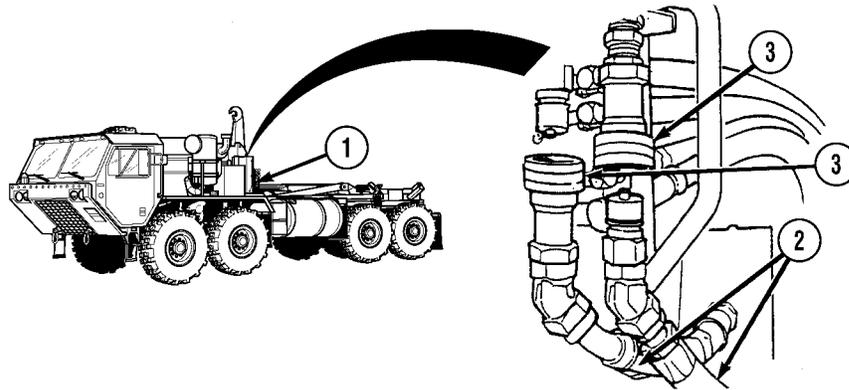

- (24) Connect hydraulic lines (2) on both trucks at quick disconnects (3) located on the back of the LHS control box (1).
- (25) When operations are completed, check hydraulic fluid levels in both trucks. Fill if necessary.

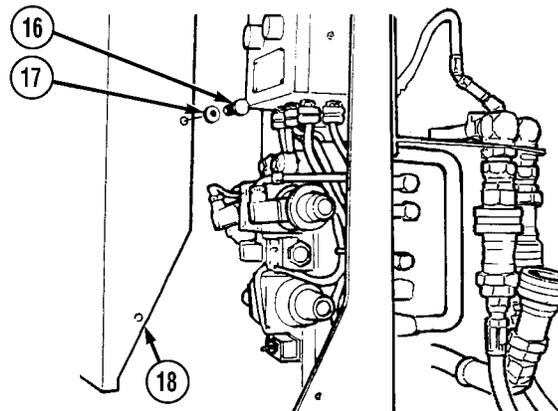

- (26) On disabled truck, install LHS control box cover (19) with four lockwashers (18) and screws (17).

Operating Instructions (Cont)

2-14. EMERGENCY PROCEDURES (CONT).

b. Manual Hydraulic Operation (LHS).

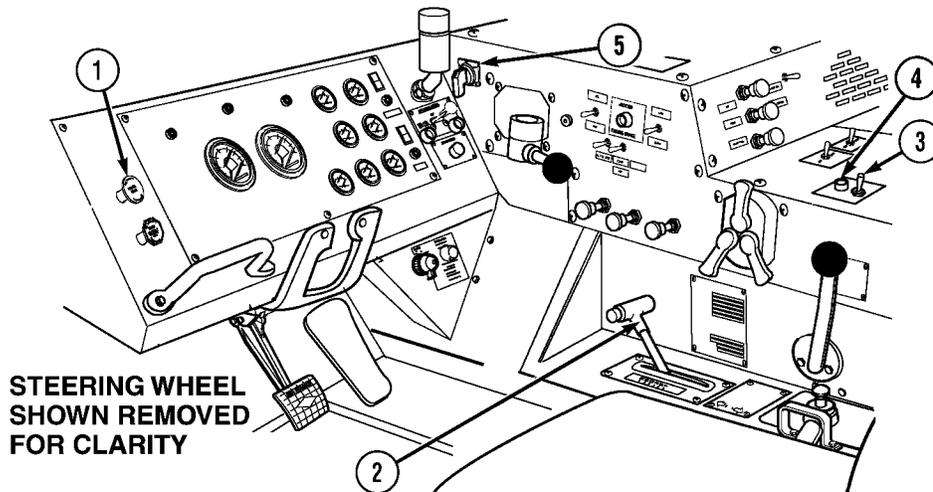

WARNING

Make sure operator, objects, and other personnel are clear of LHS and truck during LHS operation or serious injury or death could result to personnel.

NOTE

In the event of electrical failure during loading or unloading, manual operation of main manifold directional control valves will allow LHS operation until electrical failure can be repaired.

- (1) Pull out PARKING BRAKE control (1) and place transmission range selector (2) in N (Neutral).
- (2) Put PTO ENGAGE switch (3) in ON position. Make sure indicator light (4) comes on.

CAUTION

Engine speed must be at idle before using hydraulic selector switch, or damage to equipment may result.

- (3) Set hydraulic selector switch (5) to MAN H.A. position, MAN M.F. position, or AUTO position.

Operating Instructions (Cont)

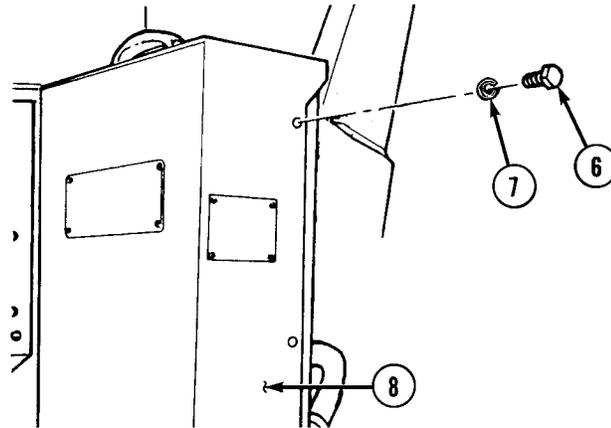
**NOTE**

Only remove center screw on engine side of LHS control box cover.

- (4) Remove four screws (6), lockwashers (7), and LHS control box cover (8) to gain access to main manifold valve on left side of truck.

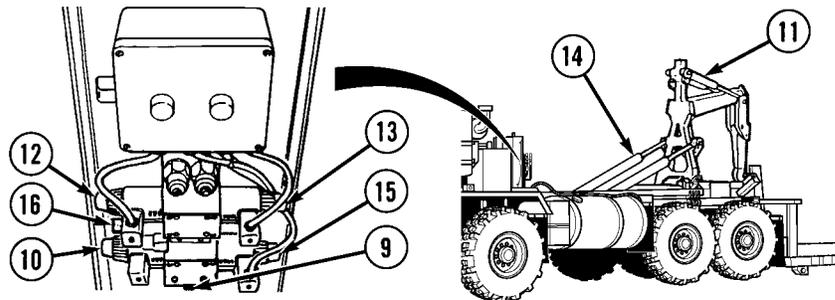
**CAUTION**

Engine speed must be at idle before hook arm cylinders are fully extended. Damage to equipment may result.

- (5) Unload flatrack from truck as follows:
- Press and hold free flow valve override button (9) and manual hook arm UP button (10) and extend hook arm cylinders (11) until hook arm cylinders are fully extended.
 - Press and hold free flow valve override button (9) and manual main frame UP button (12) until unloaded.

CAUTION

To avoid equipment damage make sure that main frame cylinders do not complete full retraction while operating at engine speeds above idle.

- (6) Load flatrack onto truck as follows:
- Press and hold manual free flow valve override button (9). Press manual main frame DOWN button (13) until main frame cylinders (14) are fully retracted.
 - Press and hold manual override button (9) and depress manual hook arm DOWN button (15) until flatrack is in transit position.
 - Press transit valve button (16) before moving truck.

Operating Instructions (Cont)

2-14. EMERGENCY PROCEDURES (CONT).

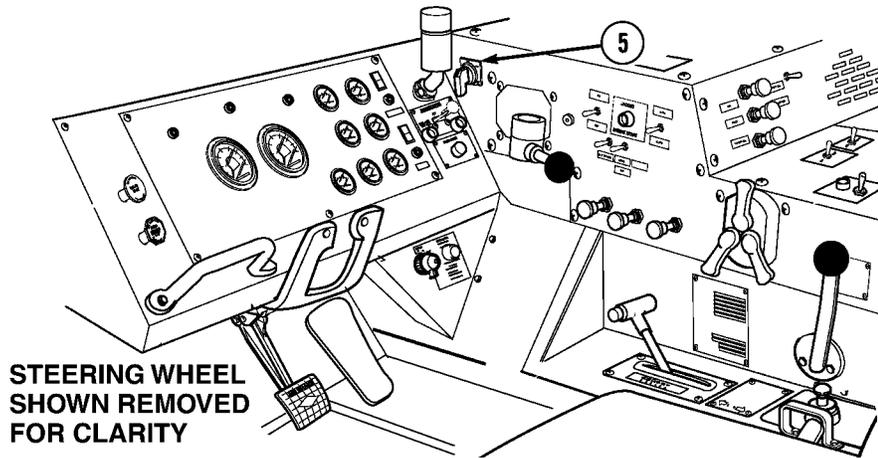

CAUTION

Engine speed must be at idle before using hydraulic selector switch, or damage to equipment may result.

- (d) Place hydraulic selector switch (5) to MAN TRANS position.

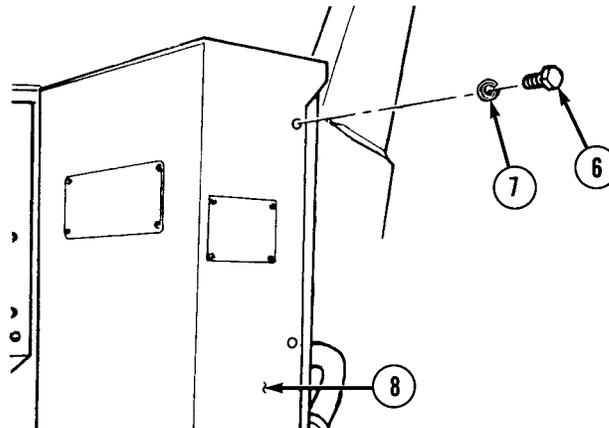

- (7) Install LHS control box cover (8) with four screws (6) and lockwashers (7).

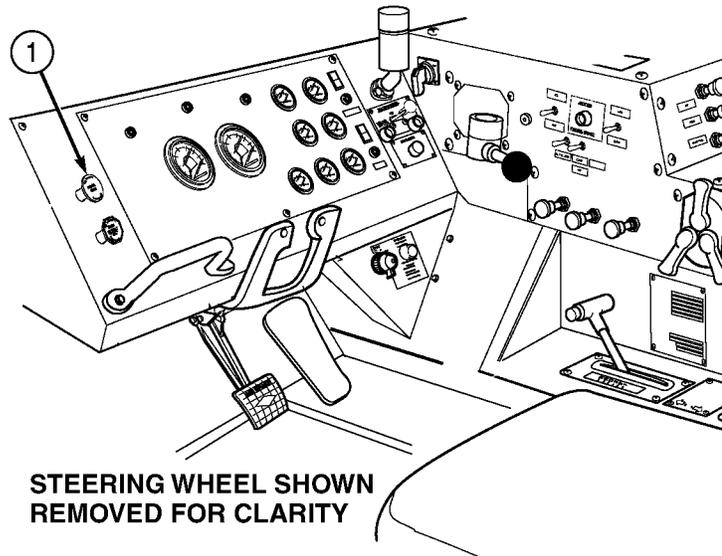
Operating Instructions (Cont)**c. Lowering the Flatrack during Complete Hydraulic Failure (Hydraulic Release).****WARNING**

Make sure operator, objects and other personnel are clear of LHS and truck during LHS operation or serious injury or death could result to personnel.

NOTE

In event of hydraulic failure during loading or unloading, load control valves fitted into system will stop LHS operation. To recover from this, solenoid valves are operated which, when open, bypass cylinder load control valves causing LHS to move under its own weight to load or unload position.

- (1) Pull out PARKING BRAKE control (1).

Operating Instructions (Cont)

2-14. EMERGENCY PROCEDURES (CONT).

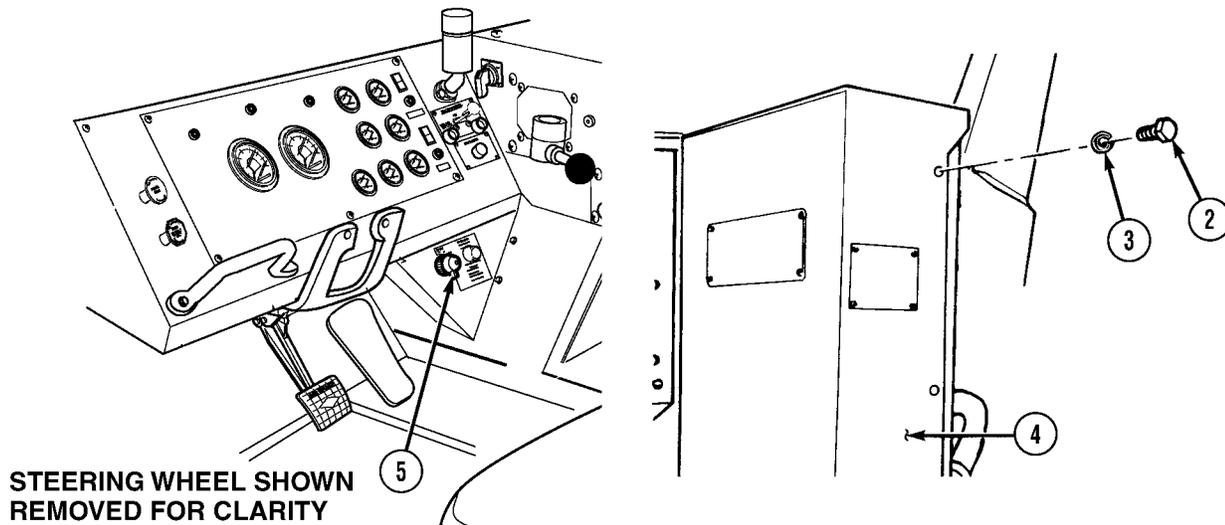

NOTE

Only remove center screw on engine side of LHS control box cover.

- (2) Remove four screws (2), lockwashers (3), and LHS control box cover (4).
- (3) Turn ignition switch (5) to ON position to allow power to electrical system, but do not start engine.

Operating Instructions (Cont)

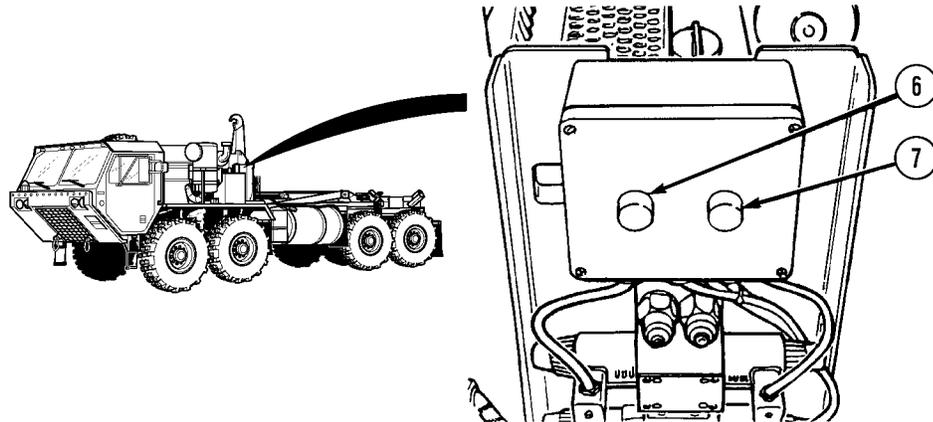

NOTE

Operate electrical lowering override buttons by pressing and releasing buttons, which controls movement of LHS.

- (4) Locate electrical hook arm override button (6) and main frame override button (7).

CAUTION

Before depressing electrical lowering override buttons, direction of LHS payload movement (load or unload) must be known.

NOTE

- If flatrack and load center of gravity is over truck, load will return to transport position. If flatrack and load center of gravity is over rear of truck, flatrack will lower to the ground.
 - Under certain circumstances, an assist truck may be needed to aid in pulling payload back if dug in.
- (5) Press main frame override button (7) for unloading. Ground conditions will determine if flatrack rolls/slides across ground or digs in. In event of digging in, operator should stop electrical override button operation. If this condition exists, the load will have to be unloaded manually.

Operating Instructions (Cont)

2-14. EMERGENCY PROCEDURES (CONT).

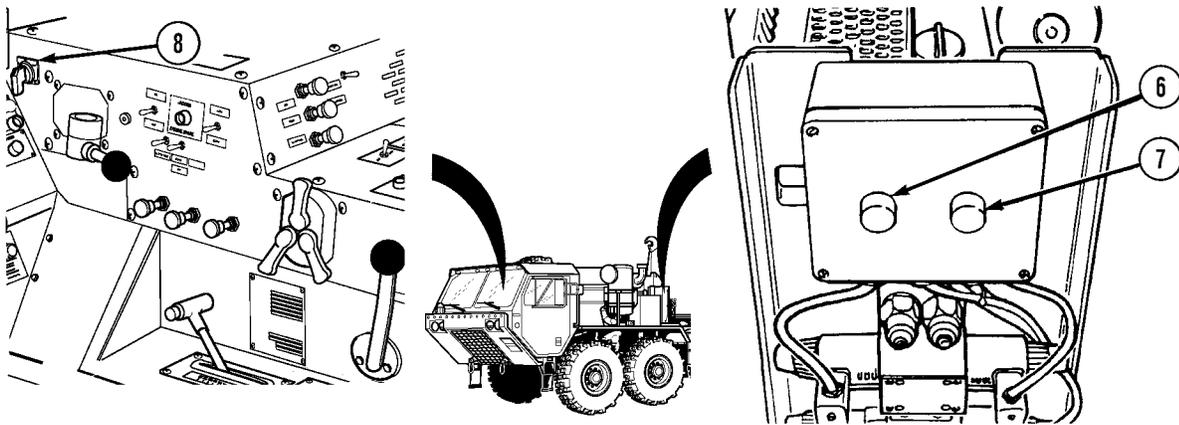

- (6) As flatrack unloads, operator continues using main frame electrical override button (7). Weight of flatrack and payload will continue until load is on ground. Operator will have to exercise caution during this procedure. If flatrack is not fully on ground, the hook arm override button (6) may be pressed until flatrack is on ground.
- (7) In event of load returning to transport position on truck during main frame override button (7) operation, the operation continues until LHS movement stops. The operator then presses the hook arm override button (6) until the hook arm cylinders are in transport position. Operator then moves hydraulic selector switch (8) to MAN TRANS position, which allows truck to be driven. Flatrack and payload must be manually off-loaded. Refer to Para 2-13d.

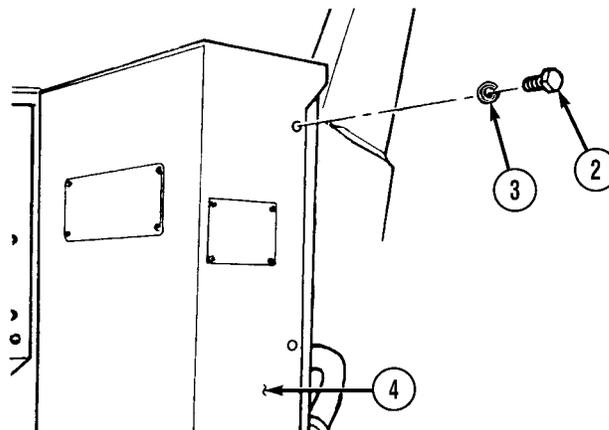

- (8) Install four screws (2), lockwashers (3), and LHS control box cover (4).

Operating Instructions (Cont)

d. Manual Removal of Flatrack.

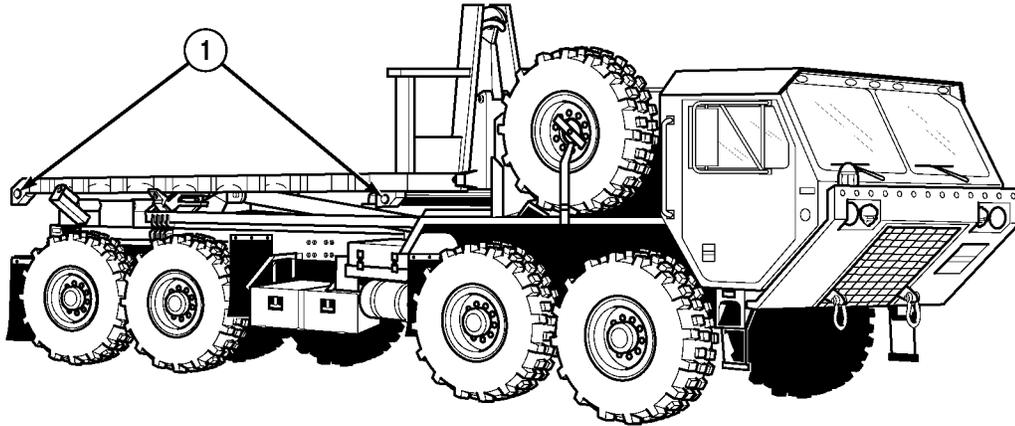

WARNING

M1077 flatrack weighs 3,200 lbs. (1 452 kg). M1077A1 flatrack weighs 3,900 lbs. (1 769 kg). Attach suitable lifting device prior to removal or installation to prevent possible injury to personnel.

CAUTION

- It is not possible to load a flatrack onto a truck in this manner or equipment damage may result.
- Attempting to unload flatrack with LHS rear load locks engaged will result in damage to flatrack and possible damage to LHS.
- Flatrack must be empty before attempting to re-engage hook and hook bar or damage to equipment may result.

NOTE

- If complete system failure or hydraulic failure as described in this paragraph does not allow normal operation, remove payload or flatrack and payload from truck.
- Flatrack is considered engaged in LHS rear load locks when any part of flatrack lock is under LHS lock.

- (1) Remove flatrack with lifting device as follows:
 - (a) Secure lifting slings to flatrack lifting eyes (1).

Operating Instructions (Cont)

2-14. EMERGENCY PROCEDURES (CONT).

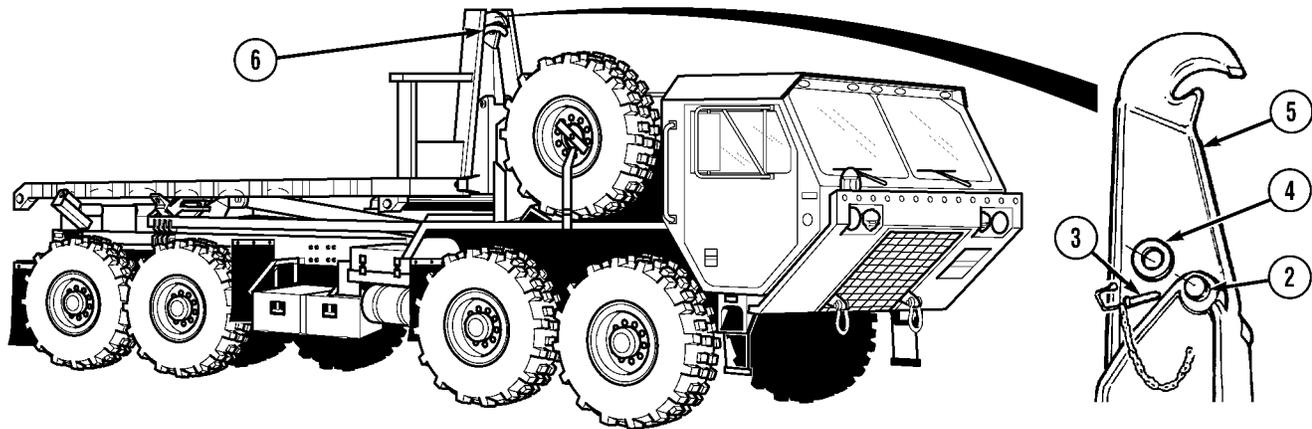

WARNING

Lift hook weighs 200 lbs. (91 kg). Attach suitable lifting device prior to removal or installation to prevent possible injury to personnel.

- (b) Apply tension to sling and lift flatrack slightly to relieve pressure on locking pin (2). Remove pin (3), washer (4), and locking pin (2) from lift hook (5).
- (c) Using a lifting device, lift flatrack slightly. (Flatrack will not rise due to flatrack hook bar being engaged under lift hook (5) and load locks being engaged.)

WARNING

Personnel must stand clear of flatrack and lift hook areas during manual unload procedures or injury to personnel may result.

- (d) Using another truck or an anchor point, pull flatrack rearwards from lift hook (5) until lift hook clears and falls free of flatrack hook bar (6).
- (2) Move lift hook back into position and install locking pin (2), washer (4), and pin (3) in lift hook (5).

Operating Instructions (Cont)

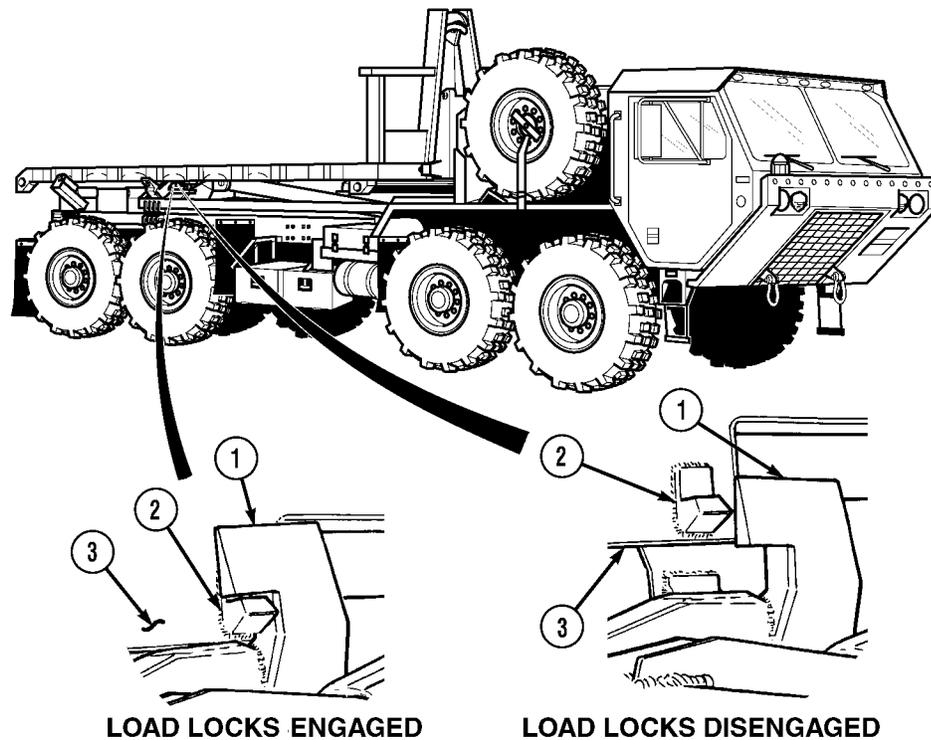
e. Manually Re-Engage Flatrack Hookbar to LHS Hook.**CAUTION**

- Attempting to unload flatrack with LHS rear load locks engaged will result in damage to flatrack and possible damage to LHS.
- Flatrack must be empty before attempting to re-engage hook and hook bar or damage to equipment may result.

NOTE

Flatrack is considered engaged in LHS rear load locks when any part of flatrack lock is under LHS lock.

- (1) Re-engage flatrack hookbar as follows:
 - (a) Visually inspect LHS rear load lock (1) and flatrack load lock (2) to determine if flatrack (3) is engaged or disengaged.
 - (b) If flatrack load lock (2) is not engaged in LHS rear load locks (1), go to step (m).
 - (c) If flatrack load lock (2) is engaged in LHS rear load locks (1), go to step (d).

Operating Instructions (Cont)

2-14. EMERGENCY PROCEDURES (CONT).

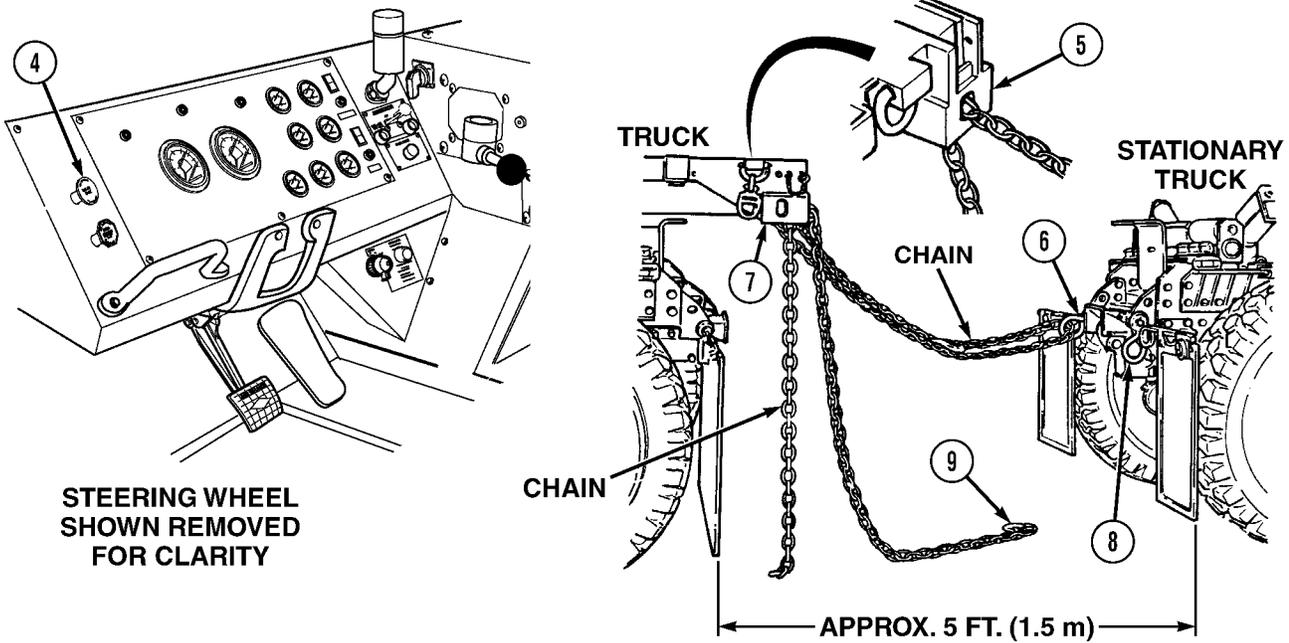

- (d) Position truck so rear of truck is about 5 ft. (1.5 m) from another stationary truck and pull out PARKING BRAKE control (4) on both trucks (TM 9-2320-279-10).

CAUTION

Use of a chain at each flatrack corner casting is required or damage to equipment can result.

NOTE

Use of the 14 ft. (4.3 m) chain from the truck BII and another chain of equal length and strength is required.

- (e) Route one chain through the right ISO corner casting (5) of truck and through the left tow shackle (6) on the stationary truck.
- (f) Route the second chain through the left flatrack ISO corner casting (7) of truck and through the right tow shackle (8) on the stationary truck.
- (g) Adjust chains to equal lengths and hook chain hooks (9) on chains.

Operating Instructions (Cont)

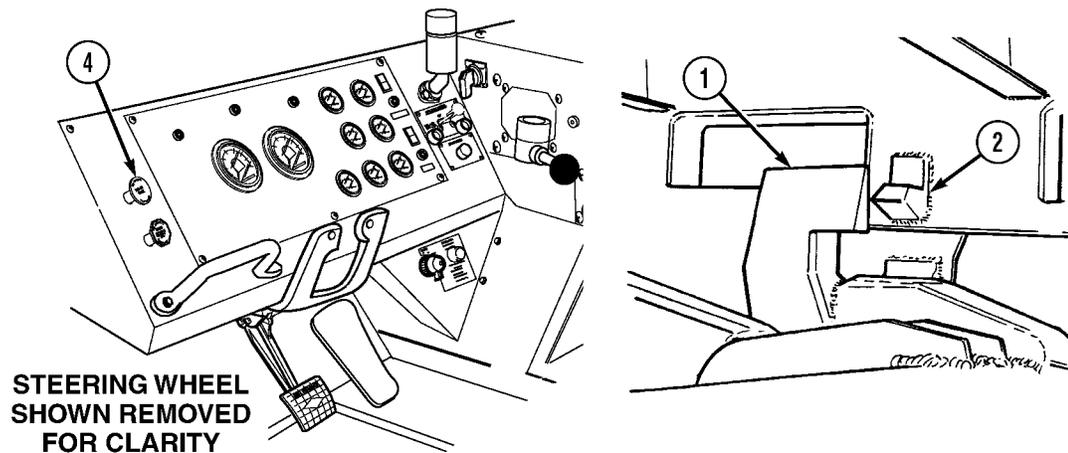

WARNING

Keep all personnel away from rear of flatrack and chains while attempting to disengage the load locks. Chains will be under great tension and could unhook or fail, resulting in serious injury or death to personnel.

CAUTION

Truck should be driven forward slowly or damage to equipment can result.

NOTE

Make sure that both chains tighten evenly when moving truck forward.

- (h) Release PARKING BRAKE control (4) and move truck forward to take slack out of chains (TM 9-2320-279-10).
- (i) Increase engine speed until flatrack load lock (2) disengages from LHS rear load locks (1).
- (j) Move truck rearward to relieve tension on chains and pull out PARKING BRAKE control (4).
- (k) Remove and stow both chains.

Operating Instructions (Cont)

2-14. EMERGENCY PROCEDURES (CONT).

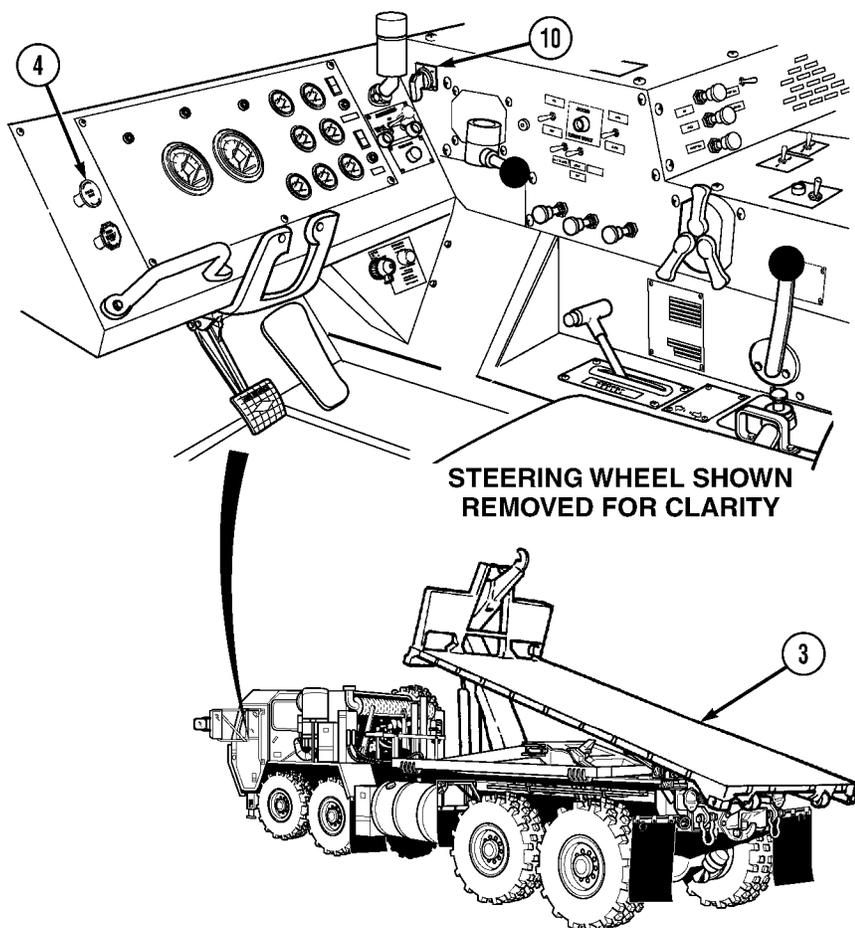

- (l) Push in PARKING BRAKE control (4) and drive truck forward to allow room for removal of flatrack (3).
- (m) Pull out PARKING BRAKE control (4).
- (n) Turn hydraulic selector switch (10) to AUTO position.

Operating Instructions (Cont)

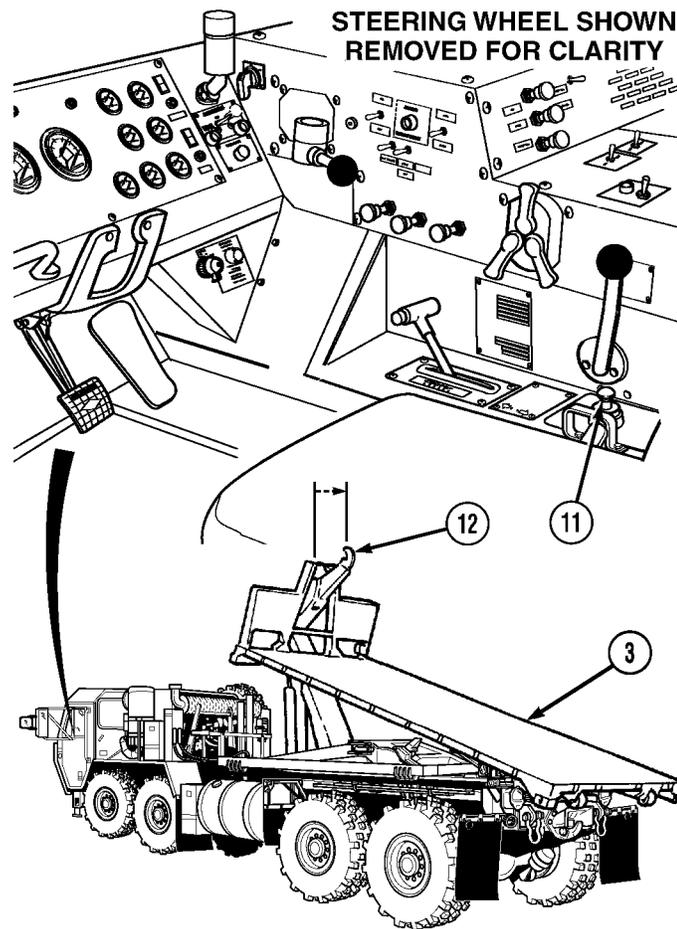
**WARNING**

Personnel must stand clear of flatrack and lift hook areas during unloading procedure or injury to personnel may result.

NOTE

Lift hook will raise with flatrack hook bar outside of lift hook. As the hook arm raises, the flatrack will move rearward and engage the lift hook.

- (o) Move the joystick (11) to UNLOAD position until the flatrack (3) engages the lift hook (12).
- (p) Refer to standard loading and unloading procedures (Para 2-9).

CHAPTER 3 OPERATOR MAINTENANCE INSTRUCTIONS

Contents	Para	Page
Maintaining Lubricant Levels	3-1	3-1
General Lubrication Instructions	3-2	3-1
Troubleshooting Introduction	3-2.1	3-4
Troubleshooting Procedures	3-3	3-4
Maintenance Introduction	3-4	3-8.4
Clean Vehicle	3-5	3-8.4

Section I. Lubrication Instructions

3-1. MAINTAINING LUBRICANT LEVELS.

Lubricant levels must be checked as specified in the PMCS (Chapter 2, Section II) and Lubrication Table. Steps must be taken to replenish and maintain lubricant levels.

3-2. GENERAL LUBRICATION INSTRUCTIONS.

WARNING

- Drycleaning Solvent (P-D-680) is TOXIC and flammable. Wear protective goggles, face shield, and gloves; use only in a well-ventilated area; avoid contact with skin, eyes, and clothes; and do not breathe vapors. Keep away from heat or flame. Never smoke when using solvent. The flashpoint for Type III Drycleaning Solvent is 200° F (93°C). Failure to do so may result in injury or death to personnel.
- If personnel become dizzy while using cleaning solvent, immediately get fresh air and medical help. If solvent contacts skin or clothes, flush with cold water. If solvent contacts eyes, immediately flush eyes with water and get immediate medical attention.

a. Cleaning Fittings Before Lubrication. Clean parts with Drycleaning Solvent P-D-680 (Item 18, Appendix F) or equivalent. Dry before lubricating. Dotted arrow points indicate lubrication on both sides of the equipment.

b. Lubrication After Fording. If fording operation occurs, lubricate all fittings below fording depth.

c. Lubrication After High-Pressure Washing. After a thorough washing, lubricate all grease fittings and oil can points outside and underneath vehicle.

d. Localized Views. A reference to the appropriate localized view is given after most lubrication entries. Localized views begin on page 3-3.

Operator Maintenance Instructions (Cont)

3-2. GENERAL LUBRICATION INSTRUCTIONS (CONT).

LUBRICANT - INTERVAL

LHS Hook Arm Pin

Lubricate.
(See Notes d and c and View 8.)

Antiseize

1.5/S

Lift Hook

Lubricate.
(See Notes b and c.)

GAA

M/50HRS

Hook Arm Cylinder Pivot Pin (Front)

Lubricate. (2 fittings)
(See Notes a and c and View 1.)

GAA

M/50HRS

Main Cylinder Pins

Lubricate. (2 fittings)
(See Notes a and c and View 2.)

GAA

M/50HRS

Hook Arm Cylinder Pivot Pin (Rear)

Lubricate. (2 fittings)
(See Notes a and c and View 3.)

GAA

M/50HRS

Hook Arm Pivot Pin (Rear)

Lubricate. (2 fittings)
(See Notes a and c and View 4.)

GAA

M/50HRS

Main Cylinder Pivot Pin (Rear)

Lubricate. (2 fittings)
(See Notes a and c and View 5.)

GAA

M/50HRS

Main Frame Pivot Pin (Rear)

Lubricate. (2 fittings)
(See Notes a and c and View 6.)

GAA

M/50HRS

Horizontal Rollers

Lubricate. (2 fittings)
(See Notes a and c and View 7.)

GAA

M/50HRS

Angled Rollers

Lubricate. (2 fittings)
(See Notes a and c and View 7.)

GAA

M/50HRS

Self-Guided Coupler

Lubricate. (5 fittings)
(See Note a.)

GAA

M/50HRS

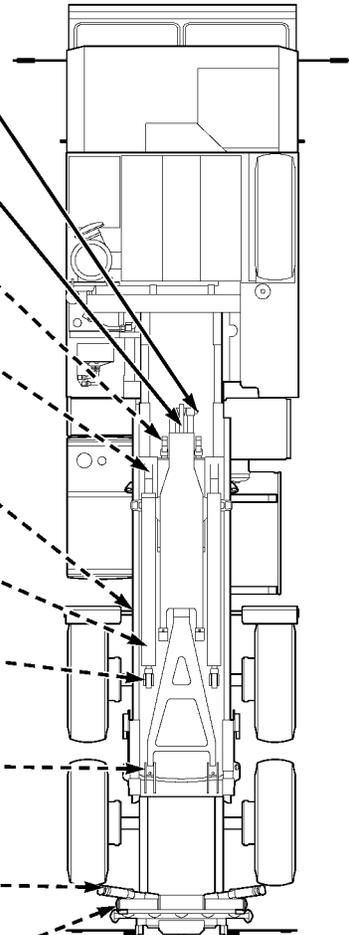

HEMTT LHS

Figure 3-1. Lubrication Points (Sheet 1 of 2).

Operator Maintenance Instructions (Cont)

Rail Strut ISO Locks

Lubricate with oil can.
(See Note f and View 9)

OE,HDO

M/50HRS

Long and Short Strut Assemblies

Lubricate. (2 fittings)
(See Notes a and a.1 and View 10)

GAA

S/5000 MILES

Flip Locks

Lubricate with oil can.
(See Note f and View 10)

OE,HDO

M/50HRS

Slider Arms

Lubricate. (4 fittings)
(See Notes a and a.1 and View 11)

GAA

M/50HRS

Slider Pivot Locks

Lubricate. (2 fittings)
(See Notes a and a.1 and View 11)

GAA

M/50HRS

Slider Pins

Lubricate. (2 fittings)
(See Notes a and a.1 and View 11)

GAA

S/5000 MILES

Slider Wear Pads and Wear Rails

Clean and coat with grease.
(See View 12)

GAA

D

Rear Container Locks

Lubricate with oil can.
(See Note f and View 12)

OE,HDO

M/50HRS

Container Lock Pivot Pins

Lubricate. (2 fittings)
(See Notes a and a.1 and View 12)

GAA

S/5000 MILES

CHU KIT

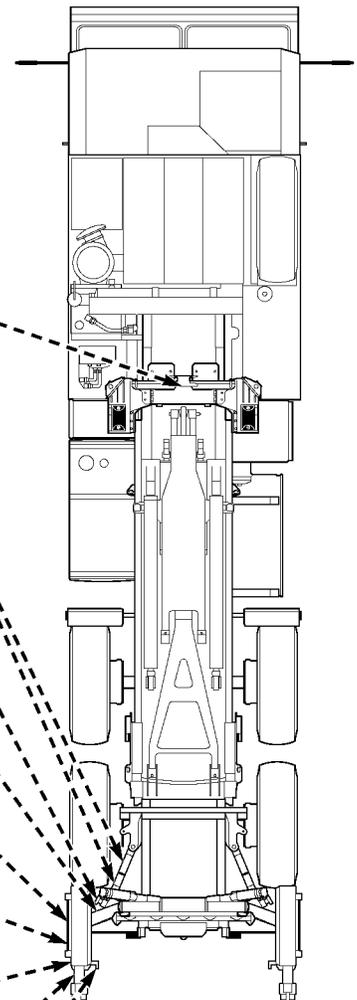

Figure 3-1. CHU Kits (Sheet 1.1 of 2).

Operator Maintenance Instructions (Cont)

3-2. GENERAL LUBRICATION INSTRUCTIONS (CONT).

Front Lift Adapter Hook Bar

Clean and coat with grease.
(See View 13)

Front Lift Adapter Locking Plates

Lubricate with oil can.
(See Note f and View 14)

Front Lift Adapter ISO Twist Locks

Lubricate with oil can.
Lubricate. (2 fittings)
(See Notes a, a.1, and f and View 15)

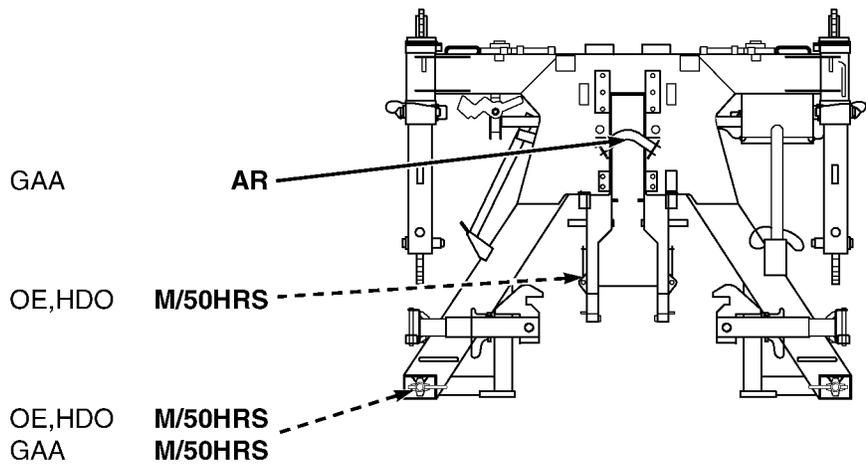

CHU KIT

Figure 3-1. CHU Kits (Sheet 1.2 of 2).

Operator Maintenance Instructions (Cont)

1 LUBE FITTING

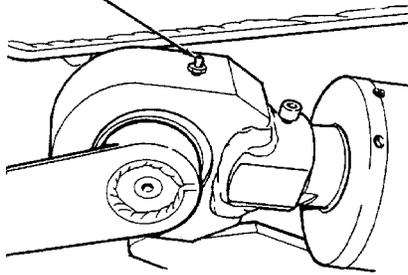

HOOK ARM CYLINDER PIVOT PIN (FRONT)

2

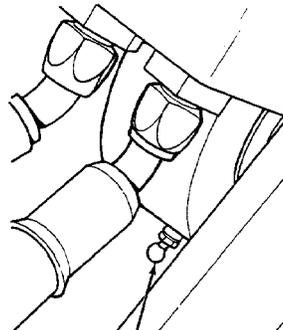

LUBE FITTING
MAIN CYLINDER PIVOT PINS (FRONT)

3

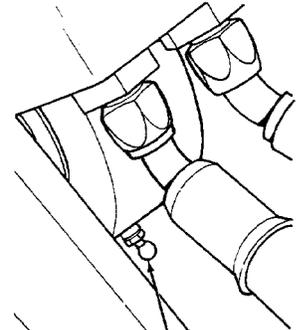

LUBE FITTING
HOOK ARM CYLINDER PIVOT PIN (REAR)

4

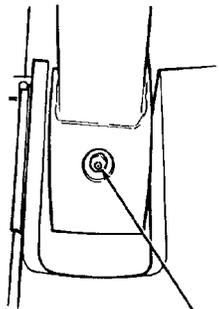

LUBE FITTING
HOOK ARM PIVOT PIN (REAR)

5

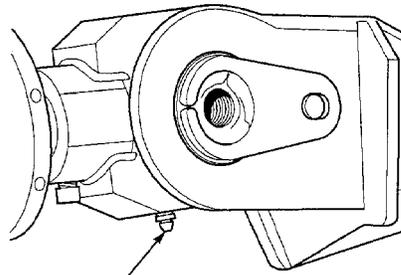

LUBE FITTING
MAIN CYLINDER PIVOT PIN (REAR)

6

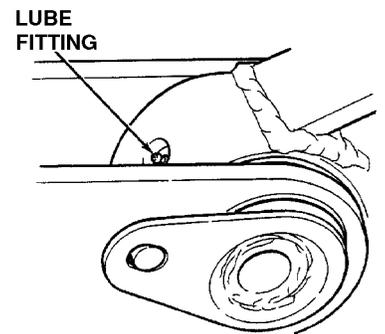

LUBE FITTING
MAIN FRAME PIVOT PIN (REAR)

7

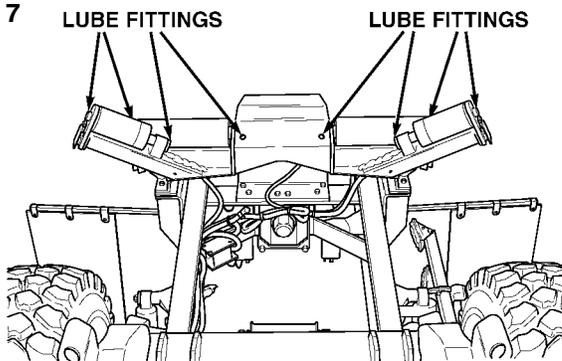

LUBE FITTINGS
LUBE FITTINGS
HORIZONTAL AND ANGLED ROLLERS

8

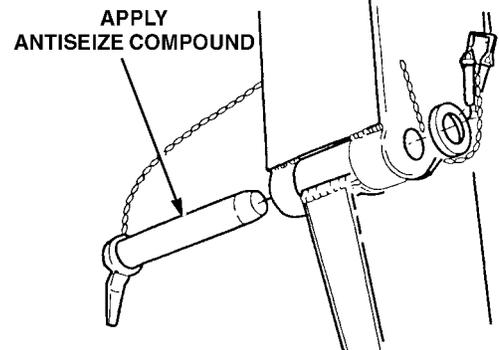

APPLY ANTISEIZE COMPOUND
LHS HOOK ARM PIN

Figure 3-1. Lubrication Points (Sheet 2 of 2).

Operator Maintenance Instructions (Cont)

3-2. GENERAL LUBRICATION INSTRUCTIONS (CONT).

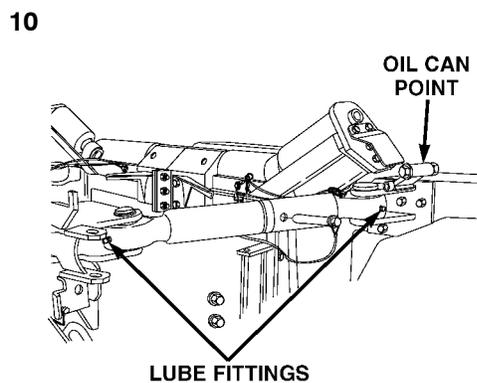
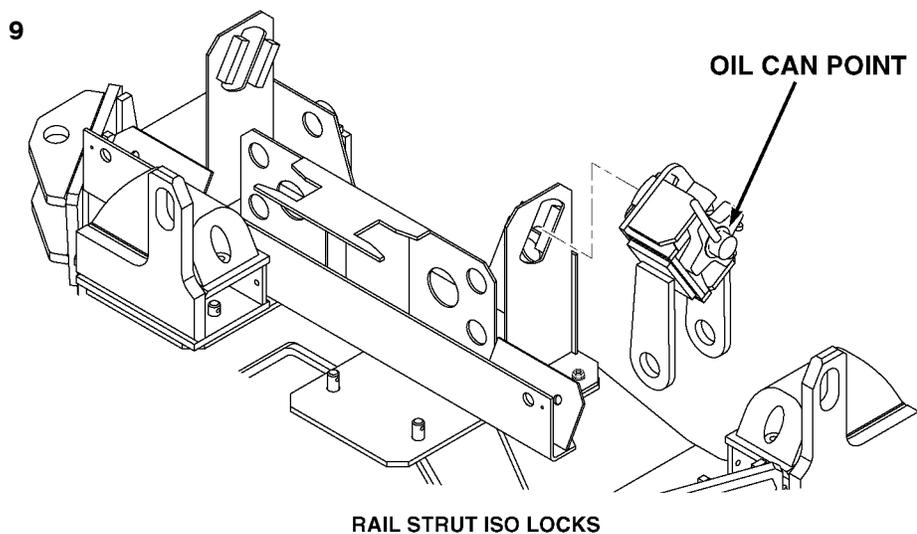

LONG AND SHORT STRUT ASSEMBLIES AND FLIP LOCKS

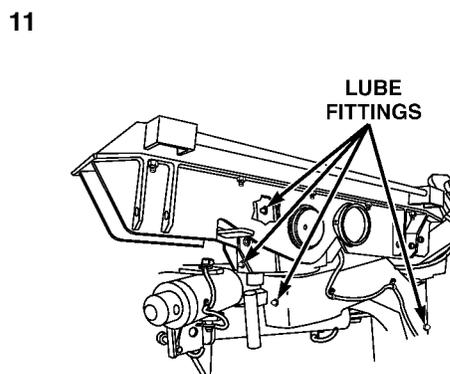

SLIDER ARMS, PIVOT LOCKS, AND PINS

Figure 3-1. Lubrication Points (Sheet 2.1 of 2).

Operator Maintenance Instructions (Cont)

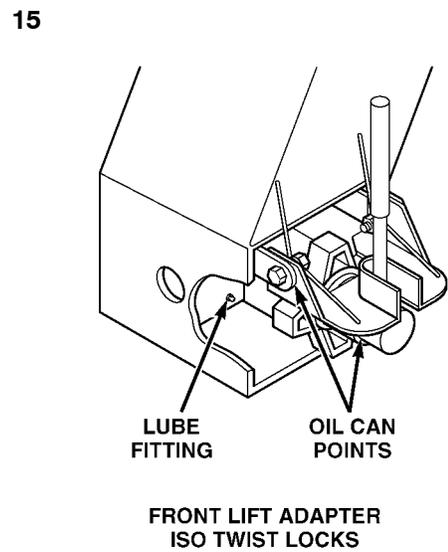
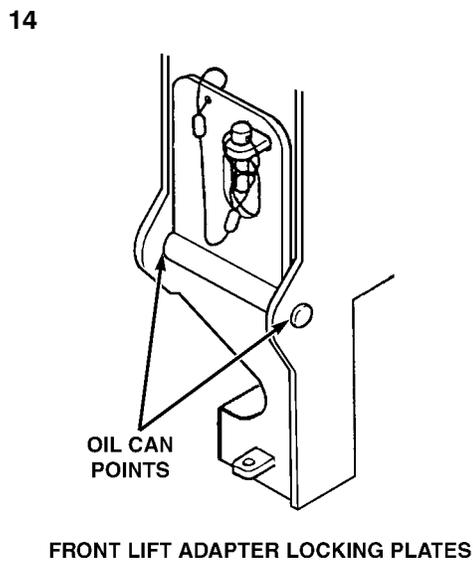
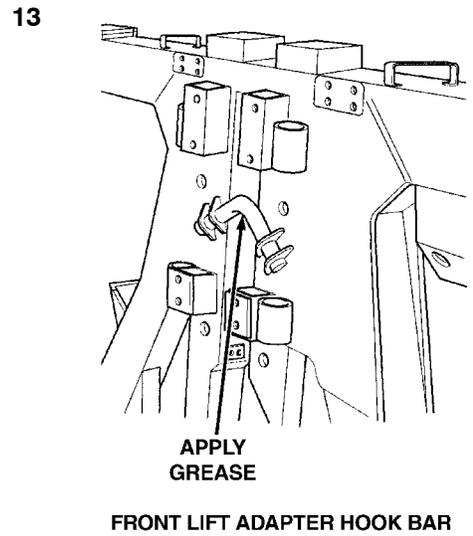
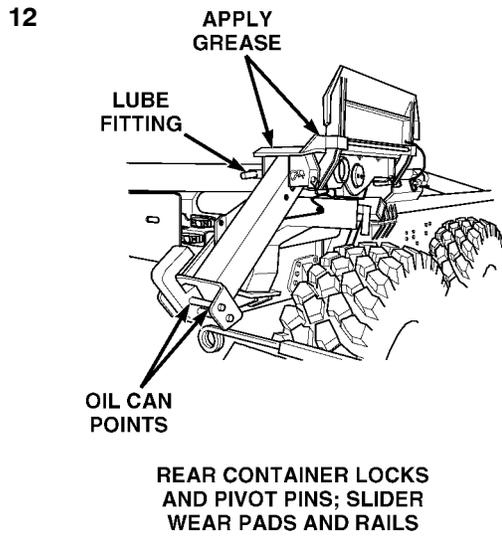

Figure 3-1. Lubrication Points (Sheet 2.2 of 2).

Operator Maintenance Instructions (Cont)

3-2. GENERAL LUBRICATION INSTRUCTIONS (CONT).

LOAD HANDLING SYSTEM (LHS).

CAUTION

Sliders may require frequent greasing (possibly every load, depending on environment) to minimize container jerking during load/unload sequence. Container jerking can result in damage to container and/or contents.

NOTE

If the part does not purge clean lubricant, notify Organizational Maintenance.

a. Purging of Lubricant. When using a grease gun, apply lubricant to the fitting until clean lubricant squeezes out of the part being lubricated.

a.1 Lubricate fittings with a manual grease gun. Do not use an air-powered grease gun.

b. Apply grease to lift hook more often if M1120 truck mileage is low, but LHS usage is high.

c. The 50 hour interval is based on actual LHS operating hours. The hours can be tracked by the operator and recorded in the logbook. The LHS should be lubricated on a monthly or 50 actual operating hour interval, whichever comes first.

d. To allow access to the hook arm cylinder rear grease fittings and LHS hook arm pin, LHS should be fully extended.

e. Remove safety pin and washer to remove LHS hook arm pin. Lubricate LHS hook arm pin and reinstall with washer and safety pin.

f. Oil Can Points. Lubricate pivot points every 1,500 mi. (2 414 km) or semiannually. Lubricate more often if usage is high.

Section II. Troubleshooting Procedures**3-2.1. TROUBLESHOOTING INTRODUCTION.**

Table 3-1 lists common malfunctions that you may find with LHS and CHU. Refer to TM 9-2320-279-10 for Troubleshooting. Perform the tests, inspections, and corrective actions in the order they appear in the table. This table cannot list all malfunctions that may occur, all tests or inspections needed to find the fault, or all corrective actions needed to correct the fault. If a malfunction is not listed or actions listed do not correct the fault, notify your supervisor.

3-3. TROUBLESHOOTING PROCEDURES.

To quickly find a troubleshooting procedure, use the Malfunction Index. Table 3-1 contains the operator troubleshooting steps.

Table 3-1. Fault Symptom Index

TROUBLESHOOTING PROCEDURE	PAGE
LOAD HANDLING SYSTEM (LHS)	
1. Load Handling System Will Not Operate	3-5
2. LHS Main Frame Cylinders Move Slowly During Unload Operation	3-6
3. LHS Moves Slowly in All Modes	3-7
4. Flatrack Disengages from LHS Hook While Attempting to Unload	3-7
CONTAINER HANDLING UNIT (CHU)	
1. Front Lift Adapter Lower Container Locks Will Not Engage Into Container Lower Castings ..	3-8
2. One or Both Rear Container Locks Cannot Be Pinned or Appear to Be Extremely Loose	3-8.1
3. One of Both Rear Container Locks Cannot Be Freed From Container	3-8.2
4. Container Jerks While in Contact With Sliders During Loading or Unloading Sequence	3-8.3

Operator Maintenance Instructions (Cont)

Table 3-2. Troubleshooting

Malfunction	Test or Inspection	Corrective Action
LOAD HANDLING SYSTEM (LHS)		
1. LOAD HANDLING SYSTEM WILL NOT OPERATE.		
NOTE		
<p>Continued repetitive cycles, approximately nine at rated 26,000 lb. payload, of the load handling system (LHS) could cause overheating and system will fail to pick up the load. Allow the hydraulic system to cool. Wait approximately 1 1/2 hours or until the hydraulic reservoir is cool. The hydraulic reservoir is cool when you can hold your hand on the reservoir for more than 10 seconds.</p>		
Step 1.	Ensure PTO ENGAGE switch (1) is in ON position and indicator light is on.	
Step 2.	Ensure transmission is N (Neutral).	
Step 3.	Ensure that hydraulic selector switch (2) is in the correct position.	
Step 4.	Check if LHS circuit breaker (3) is tripped.	
	If breaker is tripped, reset.	
	If breaker trips again, notify Organizational Maintenance.	
Step 5.	Check fluid level in the hydraulic reservoir (4).	
	If fluid level is low, notify Organizational Maintenance.	
	If fluid level is OK and problem persists, refer to Para 2-14 and perform emergency operations to complete the mission. Notify Organizational Maintenance when mission is completed.	
Step 6.	Ensure temperature of hydraulic reservoir (4) is not hot.	
	If reservoir is hot, allow to cool for 1 1/2 hours, or until reservoir is cool to the touch, before attempting to operate. If operation is unsuccessful, notify Organizational Maintenance.	

Operator Maintenance Instructions (Cont)

3-3. TROUBLESHOOTING PROCEDURES (CONT).

Table 3-2. Troubleshooting - Cont

Malfunction	Test or Inspection	Corrective Action
LOAD HANDLING SYSTEM (LHS) (CONT)		
2. LHS MAIN FRAME CYLINDERS MOVE SLOWLY DURING UNLOAD OPERATION.		
Step 1.	<p>Check fluid in hydraulic reservoir with LHS in transit position.</p> <p>If fluid level is low, notify Organizational Maintenance.</p> <p>If fluid level is OK and problem persists, go to Step 2.</p>	
Step 2.	<p>If operating in AUTO mode:</p> <ol style="list-style-type: none"> a. Throttle engine to 1,500 to maximum rpm. b. Move joystick (1) to LOAD position and hold for approximately three seconds. 	
<u>CAUTION</u>		
<p>Engine speed must be at idle before using hydraulic selector switch or damage to equipment may result.</p>		
Step 3.	<p>If operating in MAN M.F. position, move hydraulic selector switch (2) to OFF or MAN TRANS position for approximately three seconds, return switch to desired position, and continue unloading operation.</p>	
Step 4.	<p>If main frame cylinder (3) still operates slowly, repeat Step 2. and Step 3. one more time.</p>	
Step 5.	<p>If problem remains, notify Organizational Maintenance.</p>	

Operator Maintenance Instructions (Cont)

Table 3-2. Troubleshooting - Cont

Malfunction	Test or Inspection	Corrective Action
LOAD HANDLING SYSTEM (LHS) (CONT)		
3. LHS MOVES SLOWLY IN ALL MODES.	Check fluid level in hydraulic reservoir.	If fluid is low, notify Organizational Maintenance. If fluid level is OK, notify Organizational Maintenance.
4. FLATRACK DISENGAGES FROM LHS HOOK WHILE ATTEMPTING TO UNLOAD.	Manually re-engage flatrack hook bar with LHS hook (Para 2-14) and notify supervisor to contact DS Maintenance.	

Operator Maintenance Instructions (Cont)

3-3. TROUBLESHOOTING PROCEDURES (CONT).

Table 3-2. Troubleshooting - Cont

Malfunction	Test or Inspection	Corrective Action
CONTAINER HANDLING UNIT (CHU)		
<p>1. FRONT LIFTING ADAPTER LOWER CONTAINER LOCKS WILL NOT ENGAGE INTO CONTAINER LOWER CASTINGS.</p>	<p>The diagram illustrates the container locking mechanism in an 'UNLOCKED' state. Callout (1) points to the container lower castings. Callout (2) points to the lower container locks, which are shown in a straight-up position. Callout (3) points to a handle that is oriented towards the center of the truck. A curved arrow indicates the rotation of the lock handle.</p>	
<p>Step 1. Check for mud and debris around both container lower castings (1). Clean mud and debris from container castings.</p>		
<p>Step 2. Check that both lower container locks (2) are free of mud and debris and rotate freely. Clean mud and debris from container locks.</p>		
<p>Step 3. Check that both lower container locks (2) are in the straight up (UNLOCKED) position, handle (3) will face in (position toward center of truck). Position lower container lock to the UNLOCKED position.</p>		

Operator Maintenance Instructions (Cont)

Table 3-2. Troubleshooting - Cont

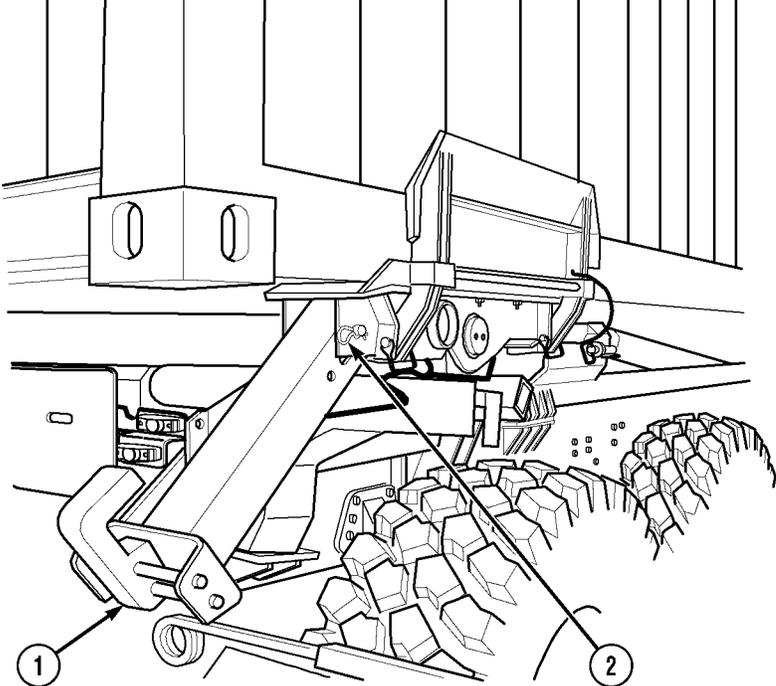
Malfunction	Test or Inspection	Corrective Action
CONTAINER HANDLE UNIT (CHU) (CONT)		
<p>2. ONE OR BOTH REAR CONTAINER LOCKS CANNOT BE PINNED OR APPEAR TO BE EXTREMELY LOOSE.</p>		<p>Step 1. Container may not be fully stowed on truck. Reload container on truck. Refer to Para 2-10.2 through 2-10.5.</p> <p>Step 2. One or both rear container locks (1) or pins (2) may be damaged or bent, notify Unit Maintenance. If pins on container locks are damaged or bent, notify Unit Maintenance.</p>

Operator Maintenance Instructions (Cont)

3-3. TROUBLESHOOTING PROCEDURES (CONT).

Table 3-2. Troubleshooting - Cont

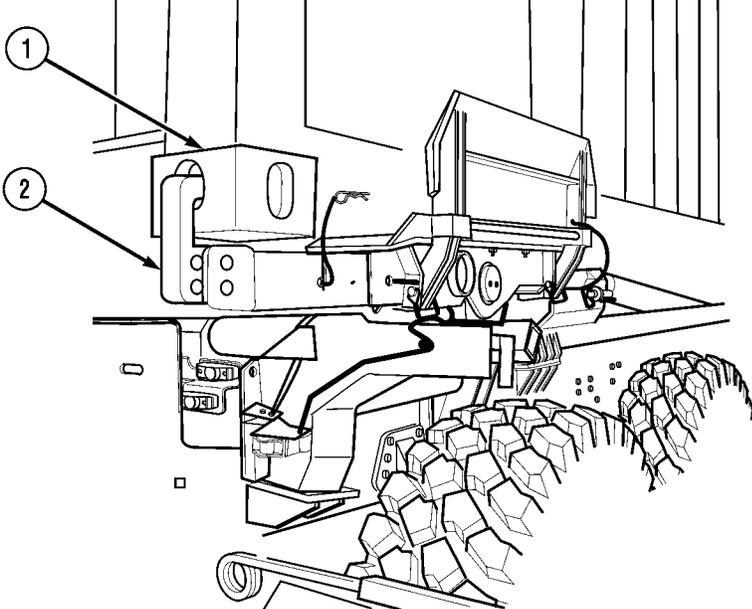
Malfunction	Test or Inspection	Corrective Action
CONTAINER HANDLING UNIT (CHU) (CONT)		
3. ONE OR BOTH REAR CONTAINER LOCKS CANNOT BE FREED FROM CONTAINER.		
		
Step 1.	Container (1) may have shifted, pinning locks (2) tight. Hit locks (2) with BII hamit to loosen them.	
Step 2.	One or both rear container locks (2) may be damaged or bent. If container locks are damaged or bent, notify Unit Maintenance.	

Operator Maintenance Instructions (Cont)

Table 3-2. Troubleshooting - Cont

Malfunction	Test or Inspection	Corrective Action
CONTAINER HANDLE UNIT (CHU) (CONT)		
<p>4. CONTAINER JERKS WHILE IN CONTACT WITH SLIDERS DURING LOADING OR UNLOADING SEQUENCE.</p>		
<p>Step 1. Sliders (1) may be lacking adequate grease to allow container to slide smoothly.</p> <p style="padding-left: 40px;">Stop sequence and grease sliders (1).</p> <p style="padding-left: 40px;">If loading, reverse sequence to remove container from contact with sliders (1) prior to greasing.</p> <p style="padding-left: 40px;">If unloading, stop sequence and attempt to grease sliders (1) as access allows.</p> <p>Step 2. Grease sliders (1) once container is unloaded.</p>		

Operator Maintenance Instructions (Cont)

Section III. Maintenance Procedures

3-4. MAINTENANCE INTRODUCTION.

This section covers maintenance tasks authorized at the operator/crew level of maintenance. The tasks given in this section do not include maintenance tasks done on a scheduled basis (PMCS).

For more information on maintenance, refer to Appendix A for maintenance publications.

3-5. CLEAN VEHICLE.

MODELS: M1120

TOOLS: None

SUPPLIES: Rags

PERSONNEL REQUIRED: MOS 88M, Motor Transport Operator

a. Clean Exterior.

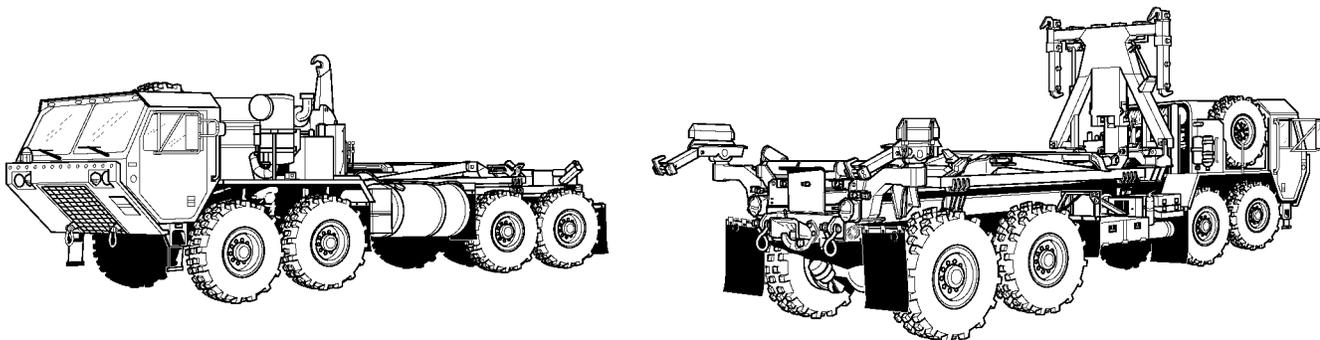

CAUTION

Do not wipe dirt off vehicle when vehicle is dry. Dirt, stones, or debris may scratch and damage vehicle.

- (1) Wash vehicle often with cool or warm water. Do not use strong detergent or abrasives.
- (2) While cleaning vehicle, look closely for rust, corrosion, bare metal, or other damage. Report any damage to Organizational Maintenance.

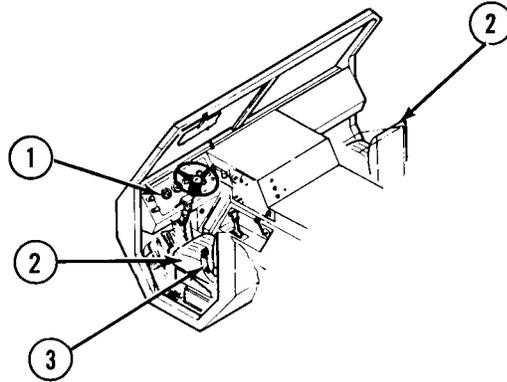
Operator Maintenance Instructions (Cont)**b. Clean Interior.**

- (1) Remove loose dirt and dust from cab interior components (1).
- (2) Clean seat cushions (2) and seat belts (3) with warm soapy water. Do not use abrasives or solvents.
- (3) Wipe seat cushions (2) and seat belts (3) dry.

CHAPTER 4

ORGANIZATIONAL MAINTENANCE INSTRUCTIONS

Contents	Para	Page
Scope	4-1	4-2.1
Maintenance Forms, Records, and Reports	4-2	4-2.1
Destruction of Army Material to Prevent Enemy Use	4-3	4-2.1
Special Tools, TMDE, and Support Equipment	4-4	4-2.1
Repair Parts	4-5	4-2.1
Reporting Equipment Improvement Recommendations (EIR)	4-6	4-2.1
Equipment Characteristics, Capabilities, and Features	4-7	4-3
Location and Description of Major Components	4-8	4-3
Equipment Data	4-9	4-3
Overview	4-10	4-3
Inspection Upon Receipt Instructions	4-11	4-3
Service Upon Receipt Instructions	4-12	4-3
General Maintenance Procedures	4-13	4-4
Preventive Maintenance Checks and Services (PMCS) Introduction	4-14	4-4
Fluid Leakage	4-15	4-5
PMCS Table	4-16	4-5
Load Handling System (LHS) Troubleshooting	4-17	4-9
Troubleshooting Instructions	4-18	4-9
Maintenance Introduction	4-19	4-143
General Removal Instructions	4-20	4-143
General Disassembly Instructions	4-21	4-143
General Cleaning Instructions	4-22	4-144
General Inspection Instructions	4-23	4-146
General Repair Instructions	4-24	4-146
General Assembly Instructions	4-25	4-147
General Installation Instructions	4-26	4-147
Preparation for Storage or Shipment Instructions	4-27	4-150
Preparation for Storage or Shipment	4-28	4-150
Overview (Electrical System)	4-29	4-150
General Wire Harness Repair	4-30	4-151
Hydraulic Selector Switch Replacement	4-31	4-160
Pilot Light Housing Replacement	4-32	4-165
LHS Circuit Breaker Replacement	4-33	4-167
Container Handling Unit (CHU) Jumperwire Harness Replacement	4-33.1	4-168.1
Container Handling Unit (CHU) Wire Harness Replacement	4-33.2	4-168.4
Load Handling System (LHS) Distribution Box Replacement	4-34	4-169
Container Handling Unit (CHU) Control Box Assembly Replacement	4-34.1	4-170.1
Container Handling Unit (CHU) Control Box Wiring Replacement	4-34.2	4-170.4
Container Handling Unit (CHU) Control Box Repair	4-34.3	4-170.9
Proximity Switch Replacement/Adjustment (Hook Arm Down)	4-35	4-171
Proximity Switch Replacement/Adjustment (Hook Arm Up)	4-36	4-174
Proximity Switch Replacement/Adjustment (Main Frame Down)	4-37	4-179
Container Handling Unit (CHU) Proximity Switch and Sensing Plate Replacement/Adjustment (Hook Arm Up)	4-37.1	4-184.1
Container Handling Unit (CHU) Main Frame Proximity Switch Replacement/Adjustment	4-37.2	4-184.7
Main Frame Lockout Relay Replacement	4-38	4-185
Safe Lowering Button Replacement	4-39	4-188
Load Handling System (LHS) Rectifier Replacement	4-40	4-194

Contents	Para	Page
LHS Junction Box Replacement	4-41	4-198
Marker/Clearance Light Replacement	4-42	4-205
Rear Light Bar Assembly Replacement	4-43	4-207
■ Container Handling Unit (CHU) Rear Light Bar Assembly Replacement	4-43.1	4-208.1
Reverse Alarm Replacement	4-44	4-209
Reverse Alarm Switch Replacement	4-45	4-211
■ Container Handling Unit (CHU) Rear Lock Limit Switch Replacement/Adjustment ..	4-45.1	4-212.1
Horizontal Roller Replacement	4-46	4-213
Angled Roller Replacement	4-47	4-216
Rear Roller Assembly Replacement	4-48	4-219
Bumper Stop Stinger Bracket Replacement	4-49	4-222
Rear Fender Replacement	4-50	4-224
Center Mud Flap Replacement	4-51	4-228
■ Ladder Bracket Replacement	4-51.1	4-228.1
Data Plate Replacement	4-52	4-229
Deck Assembly Replacement	4-53	4-232
■ Container Handling Unit (CHU) Container Guide Repair	4-53.1	4-234
Container Handling Unit (CHU) Slider/Pivot Assembly Repair	4-53.2	4-234.4
Container Handling Unit (CHU) Slider Wear Plate Replacement	4-53.3	4-234.14
Container Handling Unit (CHU) Short Strut and Pin Bracket Assembly Repair	4-53.4	4-234.17
Container Handling Unit (CHU) Rear Bracket Assembly Replacement	4-53.5	4-234.24
Container Handling Unit (CHU) Long Strut Bracket Assembly Repair	4-53.6	4-234.30
Container Handling Unit (CHU) Stowage Tray Replacement	4-53.7	4-234.40
Container Handling Unit (CHU) Front Lift Adapter Assembly Replacement	4-53.8	4-234.43
Container Handling Unit (CHU) Front Lift Adapter Locking Plate Assembly Replacement	4-53.9	4-234.55
Self-Recovery Winch (SRW) Container Handling Unit (CHU) Rear Guide Replacement	4-53.10	4-234.57
Container Handling Unit (CHU) Front Lift Adapter Lower Container Lock Plate Repair	4-53.11	4-234.60
Front Lift Adapter Lower Container Lock Repair	4-53.12	4-234.64
Container Handling Unit (CHU) Bumper Replacement	4-53.13	4-234.67
Container Handling Unit (CHU) Front Crossmember Assembly Replacement	4-53.14	4-234.69
Container Handling Unit (CHU) Front Support Brackets Replacement	4-53.15	4-234.71
Container Handling Unit (CHU) Wear Pad Replacement	4-53.16	4-234.74
Overview (Load Handling System)	4-54	4-234.75
Overview (Hydraulic System)	4-55	4-234.75
Principles of Operation	4-56	4-234.75
Hydraulic Filter and Housing Replacement	4-57	4-234.75
Hydraulic Hose Replacement	4-58	4-234.76

Organizational Maintenance Instructions (Cont)

Section I. General Information

4-1. SCOPE.

This chapter supplements the M977 Series Manuals and provides general information, equipment descriptions, and principles of operation for the LHS system on the M1120 HEMTT with LHS.

4-2. MAINTENANCE FORMS, RECORDS, AND REPORTS.

Refer to Para 2-4 for instructions on maintenance forms, records, and reports.

4-3. DESTRUCTION OF ARMY MATERIAL TO PREVENT ENEMY USE.

Command decision, according to tactical situation, will determine when the destruction of the truck will be accomplished. A destruction plan will be prepared by the using organization unless one has been prepared by a higher authority. For general destruction procedures for this truck, refer to TM 750-244-6, Procedures for Destruction of Tank-Automotive Equipment to Prevent Enemy Use (US Army Tank-automotive and Armament Command).

4-4. SPECIAL TOOLS, TMDE, AND SUPPORT EQUIPMENT.

The Maintenance Allocation Chart (MAC) identifies the authority and responsibility for maintenance tasks listed in this manual. Tool kits, test equipment, and diagnostic equipment required for performing Organizational Maintenance tasks are also identified in the MAC. The Repair Parts and Special Tools List (RPSTL), lists special tools, TMDE, and support equipment required to perform unit procedures. Tools that are to be fabricated are listed in Appendix H.

4-5. REPAIR PARTS.

Repair parts are listed and illustrated in the Repair Parts and Special Tools List (Appendix C) covering Organizational Maintenance for this vehicle.

4-6. REPORTING EQUIPMENT IMPROVEMENT RECOMMENDATIONS (EIR).

Refer to Para 1-3 for information of EIR.

Organizational Maintenance Instructions (Cont)

Section II. Equipment Description and Data

Refer to TM 9-2320-279-10 for M1120 vehicle characteristics, capabilities, and features. Refer to Para 1-9 for LHS characteristics, capabilities, and features.

4-7. EQUIPMENT CHARACTERISTICS, CAPABILITIES, AND FEATURES.

Refer to Para 1-9 for equipment characteristics, capabilities, and features.

4-8. LOCATION AND DESCRIPTION OF MAJOR COMPONENTS.

Refer to TM 9-2320-279-10 for location and description of major vehicle components. Refer to Para 1-10 for location and description of major components of the LHS and the CHU.

4-9. EQUIPMENT DATA.

Refer to Para 1-11 for equipment data.

4-10. OVERVIEW.

This chapter supplements the TM 9-2320-279-20 manual set. This chapter is used for maintenance of the Load Handling System (LHS) on the M1120 truck.

Section III. Service Upon Receipt

The following procedures provide instructions for preparing the vehicle for use. Service Upon Receipt instructions are divided into two areas: inspection and servicing.

4-11. INSPECTION UPON RECEIPT INSTRUCTIONS.

Refer to TM 9-2320-279-20 for inspection upon receipt instructions.

4-12. SERVICE UPON RECEIPT INSTRUCTIONS.

- a.* Refer to TM 9-2320-279-20 for service upon receipt instructions.

WARNING

Tire pressure must be checked properly or serious injury or death to personnel may occur. Refer to TM 9-2320-279-10 for proper tire pressure check instructions.

- b.* Refer to TM 9-2320-279-10 for proper tire pressure check instructions. Refer to Table 1-1 for proper tire pressures for HEMTT and LHS.

- c.* Perform Preventive Maintenance Checks and Services (PMCS) for LHS in Section IV.

- d.* Perform Preventive Maintenance Checks and Services (PMCS) for vehicle (refer to TM 9-2320-279-20).

Organizational Maintenance Instructions (Cont)

Section IV. Preventive Maintenance Checks and Services (PMCS)

4-13. GENERAL MAINTENANCE PROCEDURES.**WARNING**

- Drycleaning solvent (P-D-680) is TOXIC and flammable. Wear protective goggles, face shield, and gloves; use only in a well-ventilated area; avoid contact with skin, eyes, and clothes; and do not breathe vapors. Keep away from heat or flame. Never smoke when using solvent. The flashpoint for Type III Drycleaning Solvent is 200° F (93°C). Failure to do so may result in injury or death to personnel.
- If personnel become dizzy while using cleaning solvent, immediately get fresh air and medical help. If solvent contacts skin or clothes, flush with cold water. If solvent contacts eyes, immediately flush eyes with water and get immediate medical attention.

a. Cleanliness. Dirt, grease, oil, and debris only get in the way and may cover up a serious problem. Use drycleaning solvent (Item 18, Appendix F) on metal surfaces and soapy water on rubber.

b. Bolts, Nuts, and Screws. Check bolts, nuts, and screws for obvious looseness, missing, bent, or broken condition and tighten or replace as necessary. If they cannot be checked with a tool, look for chipped paint, bare metal, or rust around bolt heads.

c. Welds. Look for loose or chipped paint, rust, or gaps where parts are welded together. If a bad weld is found, notify the supervisor.

d. Electric Wires and Connectors. Look for cracked or broken insulation, bare wires, and loose or broken connectors. Tighten loose connectors and make sure the wires are in good shape.

e. Fluid Hoses, Tubes, and Fittings. Look for wear, damage, leaks, and make sure clamps and fittings are tight. Wet spots show leaks, but a stain around a fitting or connector may also indicate a leak. If connector or fitting is loose, tighten it. If something is broken or worn out, repair or replace per applicable procedure.

f. Damage. Damage is defined as any condition that affects safety or would make the truck unserviceable for mission requirements.

**4-14. PREVENTIVE MAINTENANCE CHECKS AND SERVICES (PMCS)
INTRODUCTION.**

This section contains Organizational Maintenance PMCS requirements for the LHS on the M1120 truck. The PMCS tables contain checks and services necessary to ensure the LHS is ready for operation. Using the PMCS tables, perform maintenance at the specified intervals. Perform operator's preventive maintenance checks and services in Tables 2-1 and 2-2 before doing the Unit preventive maintenance. Refer to TM 9-2320-279-20 for vehicle PMCS requirements.

Organizational Maintenance Instructions (Cont)

4-15. FLUID LEAKAGE.

It is necessary to know how fluid leakage affects the status of fuel, oil, coolant, and the hydraulic systems. The following are definitions of the types/classes of leakage necessary to know in order to determine the status of the truck. Learn, then be familiar with them and REMEMBER - WHEN IN DOUBT, NOTIFY THE SUPERVISOR!

CAUTION

Equipment operation is allowable with minor leakage (Class I or II). Consideration must be given to the fluid capacity in the item/system being checked/inspected. When in doubt, notify the supervisor. When operating with Class I or II leaks, continue to check fluid levels as required in the PMCS. Class III leaks should be repaired per applicable procedure.

- a. Class I.** Seepage of fluid as indicated by wetness or discoloration not great enough to form drops.
- b. Class II.** Leakage of fluid great enough to form drops but not enough to cause drops that fall from the item being checked/inspected.
- c. Class III.** Leakage of fluid great enough to form drops that fall from the item being checked/inspected.

4-16. PMCS TABLE.

- a.** Always do the PREVENTIVE MAINTENANCE in the same order until it gets to be a habit. Once practiced, it will be easy to spot anything wrong in a hurry. Perform the checks and services listed in Table 4-1 in the order listed.
- b.** If something does not work, troubleshoot with instructions in Table 4-2.
- c.** If anything looks wrong and is not fixed, write it on a DA Form 2404.
- d.** When doing preventive maintenance, take along the tools and supplies needed to make all the checks, including a clean cloth or two.
- e.** The following is a breakdown of the PMCS table:
 - (1) "Item No." column. Checks and services are numbered in a logical order for moving around the truck. The item number column is used as a source of items numbers for the TM Number Column on DA Form 2404, Equipment Inspection and Maintenance Worksheet, for recording results of the PMCS.
 - (2) "Interval" column. The column identifies when the PMCS should be performed. Lubrication services coincide with the vehicle's Semiannual Preventive Maintenance Service.
 - (3) "Item to Check/Service" column. This column identifies the item to be inspected.
 - (4) "Procedure" column. This column contains all the information required to do the check/service. Art is integrated into the column to aid the user in identifying items. Whenever replacement or repair is recommended, reference is made to the applicable maintenance instructions.
 - (5) "Not Fully Mission Capable if:" column. This column contains a brief statement of the condition (e.g., malfunction, shortage) that would cause the vehicle to be less than fully ready to perform its assigned mission.

Organizational Maintenance Instructions (Cont)

4-16. PMCS TABLE (CONT).

NOTE

If the vehicle must be kept in continuous operation, do only the procedures that can be done without disturbing operation. Make complete checks and services when the vehicle is shut down.

f. Perform all Semiannual Inspections in addition to the Annual inspections at the time of the Annual inspection. Perform all annual and semiannual inspections in addition to the Biennial inspections at the time of the Biennial inspection.

g. Engine oil/transmission/hydraulic fluids must be sampled at 100 hours of operation or at 90-day intervals, whichever comes first, as prescribed by DA Pam 738-750. Hard-time intervals will be applied in the event AOAP laboratory support is not available.

Table 4-1. Unit Level Preventive Maintenance Checks and Services (PMCS)

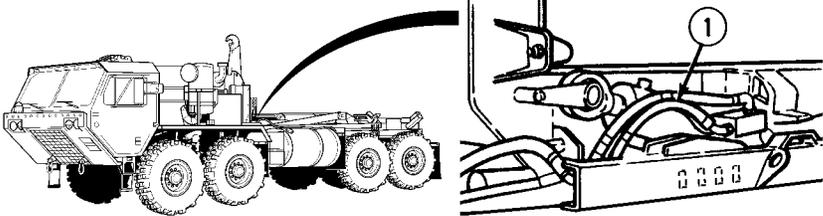
Item No.	Interval	Location	Procedure	Not Fully Mission Capable if:
		Item to Check/ Service		
1	Semi-annual	 <p>Hydraulic Hoses and Tubes</p>	Follow routing of all hydraulic hoses and tubes (1). Inspect for loose fittings, chafing, cracks, and leaks.	Loose fittings, chafing, cracks, or leaks are found.

Organizational Maintenance Instructions (Cont)

Table 4-1. Unit Level Preventive Maintenance Checks and Services (PMCS) (Cont)

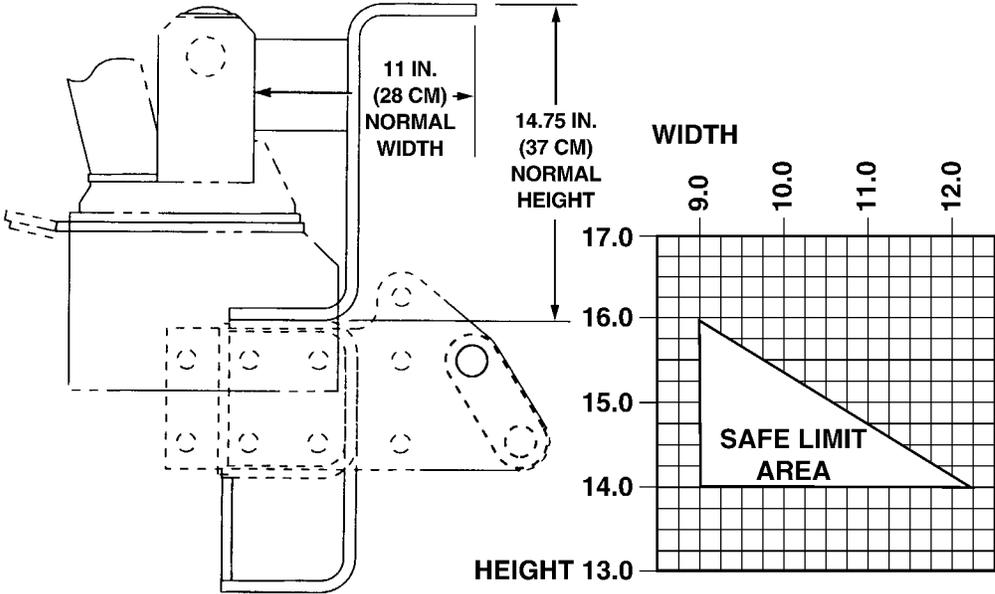
Item No.	Interval	Location	Procedure	Not Fully Mission Capable if:	
		Item to Check/Service			
2	Semi-annual	Bumper Stop Bracket	 <p>The diagram shows a bumper stop bracket with a normal width of 11 IN. (28 CM) and a normal height of 14.75 IN. (37 CM). To the right is a graph with 'WIDTH' on the x-axis (9.0, 10.0, 11.0, 12.0) and 'HEIGHT' on the y-axis (13.0, 14.0, 15.0, 16.0, 17.0). A shaded triangular region labeled 'SAFE LIMIT AREA' is bounded by the y-axis, the line from (9.0, 16.0) to (12.0, 14.0), and the horizontal line at height 14.0.</p>	<p>Check bumper stop bracket for cracks and/or broken parts. Gouges and scrapes are acceptable as long as they do not wear through the face plate. Measure height and width of bumper stop bracket. If both measurements are within safe limit area on graph, the bumper stop bracket is good. If both measurements are not within safe limit area on graph, refer to Para 4-49.</p>	<p>Either the height or width measurement is outside the safe limit area on graph.</p>

Organizational Maintenance Instructions (Cont)

4-16. PMCS TABLE (CONT).

Table 4-1. Unit Level Preventive Maintenance Checks and Services (PMCS) (Cont)

Item No.	Interval	Location	Procedure	Not Fully Mission Capable if:
		Item to Check/ Service		
3	Semi-annual	Self-Guided Coupler		<p>Radial wear exceeds 3/16 in. (4.76 mm).</p> <p>Washer thickness is less than 3.16 in. (4.76 mm).</p>

Organizational Maintenance Instructions (Cont)

Table 4-1. Unit Level Preventive Maintenance Checks and Services (PMCS) (Cont)

Item No.	Interval	Location	Procedure	Not Fully Mission Capable if:
		Item to Check/Service		
			<p>If circumference at worn area of coupler jaw (4) is less than 8-1/2 in. (215.9 mm), replace coupler at next scheduled service. If circumference is less than 8-1/4 in. (209.6 mm), replace coupler before next mission. Refer to TM 9-2320-279-20.</p>	<p>Circumference at worn area is less than 8-1/4 in. (209.6 mm).</p>
4	Semi-annual	Front Lift Adapter (FLA)	<p>If truck is equipped with Container Handling Unit (CHU), check front lift adapter (1) for cracks or broken welds.</p>	<p>Cracks or broken welds are found.</p>
5	Semi-annual	Rear Container Locks	<p>(a) Check rear container locks (2) for cracks or broken welds.</p> <p>(b) Check for cracked, bent or missing hooks (3).</p>	<p>Cracks or broken welds are found.</p> <p>Cracked, broken or missing hooks.</p>

Organizational Maintenance Instructions (Cont)

4-16. PMCS TABLE (CONT).

Table 4-1. Unit Level Preventive Maintenance Checks and Services (PMCS) (Cont)

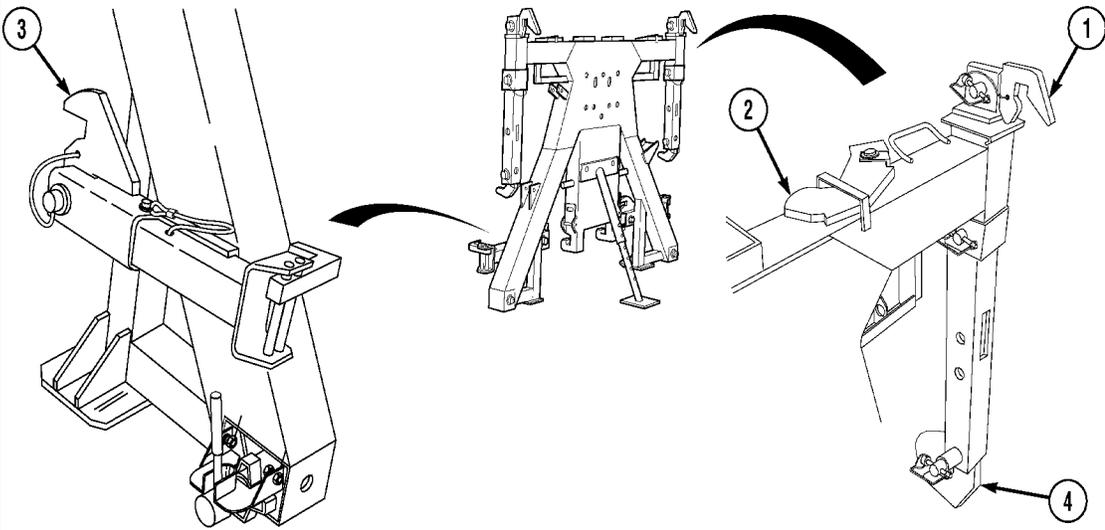
Item No.	Interval	Location	Procedure	Not Fully Mission Capable if:
		Item to Check/ Service		
6	Semi-annual	 <p>Hooks</p>	<p>Check standard hooks (1), six foot hooks (2), half height hooks (3) and hooks (4) for cracks or bends.</p>	<p>Cracked or bent hooks are found.</p>

Organizational Maintenance Instructions (Cont)

Table 4-1. Unit Level Preventive Maintenance Checks and Services (PMCS) (Cont)

Item No.	Interval	Location	Procedure	Not Fully Mission Capable if:
		Item to Check/Service		
7	Semi-annual	Bail Bar Lock	Check bail bar lock (1) for cracks or broken welds.	Cracks or broken welds are found.
8	Semi-annual	Slide Arm Weldments	Check slide arm weldments (2) for cracks or broken welds.	Cracks or broken welds are found.
9	Semi-annual	Upper and Lower Support Leg	Check upper support leg (3) and lower support leg (4) for cracks or broken welds.	Cracks or broken welds are found.

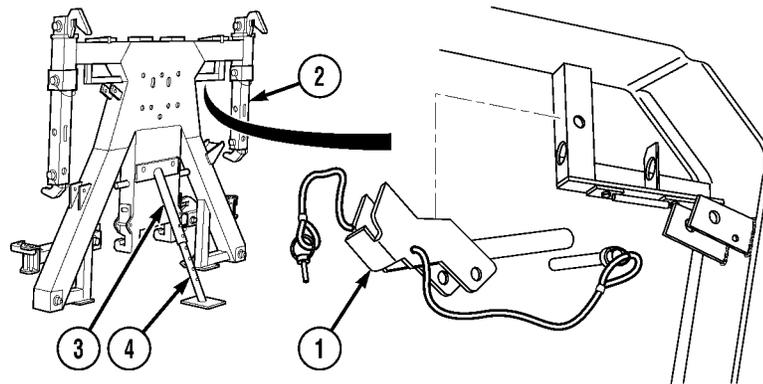

Organizational Maintenance Instructions (Cont)

4-16. PMCS TABLE (CONT).

Table 4-1. Unit Level Preventive Maintenance Checks and Services (PMCS) (Cont)

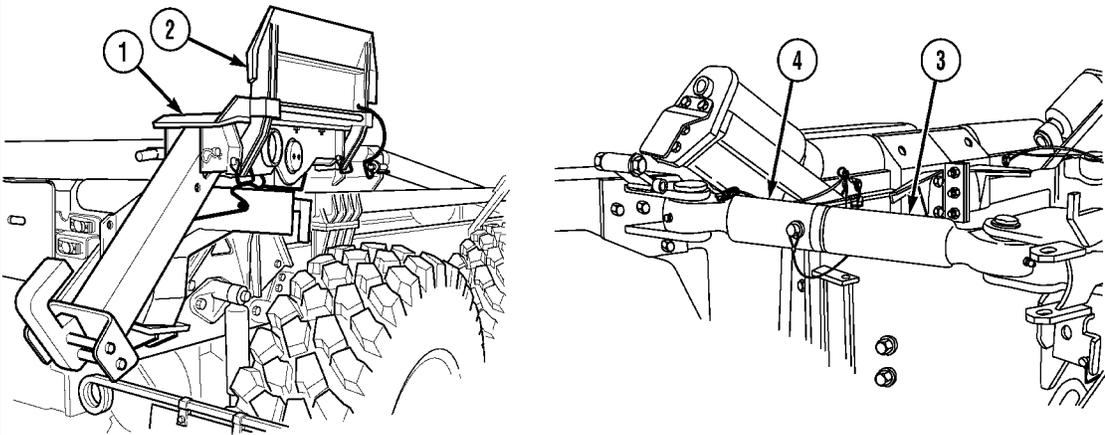
Item No.	Interval	Location	Procedure	Not Fully Mission Capable if:
		Item to Check/ Service		
				
10	Semi-annual	Rear Sliders	Check rear sliders (1) for cracks or broken welds.	Cracks or broken welds are found.
11	Semi-annual	Container Guides	Check container guides (2) for cracks or broken welds.	Cracks or broken welds are found.
12	Semi-annual	Long and Short Struts	(a) Check long strut (3) and short strut (4) for cracks or broken welds. (b) Check struts for deformity and warping.	Cracks or broken welds are found. If struts can not be connected.

Organizational Maintenance Instructions (Cont)

Table 4-1. Unit Level Preventive Maintenance Checks and Services (PMCS) (Cont)

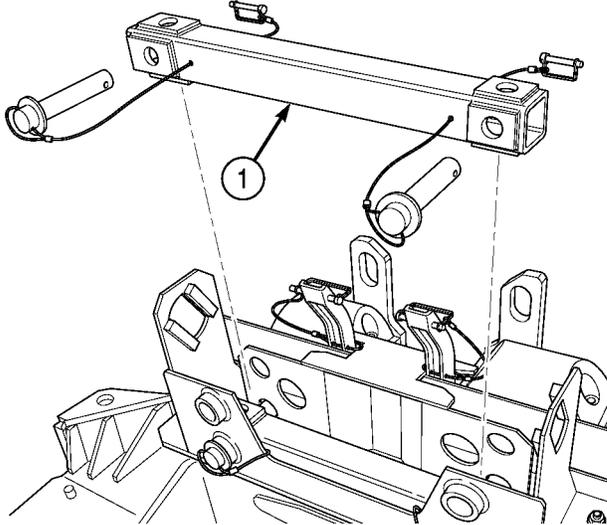
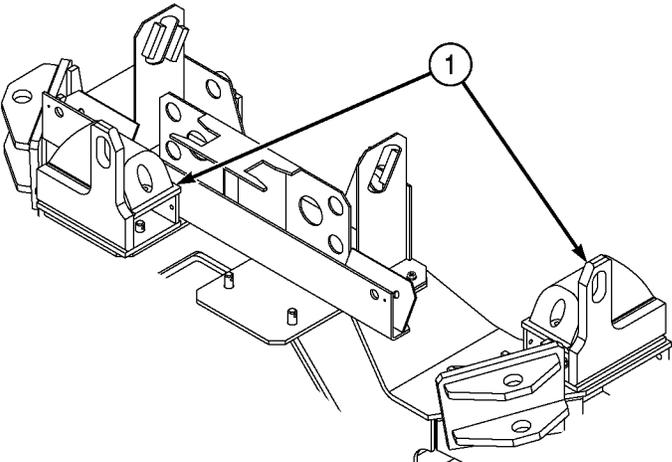
Item No.	Interval	Location	Procedure	Not Fully Mission Capable if:
		Item to Check/Service		
13	Semi-annual	Rail Supports		Cracks or broken welds are found (only if needed for mission).
			<p>Check rail supports (1) for cracks or broken welds.</p>	
14	Semi-annual	Bumper Support		Cracks or broken welds are found.
			<p>Check bumper support (1) for cracks or broken welds.</p>	

Section V. Troubleshooting

4-17. LOAD HANDLING SYSTEM (LHS) TROUBLESHOOTING.

This section covers Load Handling System (LHS) Troubleshooting. The LHS Fault Index, Table 4-2, lists faults for the LHS of the M1120 truck. The LHS-CHU Fault Index, Table 4-2.1, lists faults for the LHS-CHU on the M1120 truck.

4-18. TROUBLESHOOTING INSTRUCTIONS.

a. Measurements Required for Troubleshooting.

CAUTION

Use properly sized test leads and ensure care is used when checking for resistance, continuity, or voltage at connectors, or damage to equipment may result.

- (1) Resistance measurements.
 - (a) Connect red test lead to Volt-Ohm input connector and black lead to COM input connector on meter.
 - (b) Set the function/range switch to the desired Ohm position. If the magnitude of the resistance is not known, set the switch to the highest range, then reduce until a satisfactory reading is obtained.
 - (c) If the resistance being measured is connected to a circuit, turn ENGINE switch to OFF position.
 - (d) Connect test leads to the circuit being measured. When measuring high resistance, be careful not to contact adjacent points, even if they are insulated. Some insulators have a relatively low insulation resistance which can affect the resulting measurement.
 - (e) Read the resistance value on the digital display.

Organizational Maintenance Instructions (Cont)

4-18. TROUBLESHOOTING INSTRUCTIONS (CONT).

- (2) Continuity checks.
- (a) Place the function/range switch in any Ohm range.

NOTE

Some meters show “1+m”, or simply “1” when function/range switch is in any Ohm position.

- (b) Connect the red test lead to the Volt-Ohm connector and black lead to COM input connector on the meter. When the test leads are separated or measuring an out-of-range resistance, the digital display will indicate “OL” (Over Limit).
- (c) Put one test probe at one end of the wire or circuit to be tested. Use the other test lead to trace the circuit. When continuity is established, an Ohm symbol will appear in the upper left corner of the digital display. If contact in the wire is maintained long enough (about 1/4 of a second), the OL will disappear and the resistance value of the wire or circuit will appear next to the symbol.
- (d) If your multimeter does not work in this manner, learn how it operates before performing troubleshooting.
- (3) Voltage measurements. The M1120 is equipped with 24-Vdc circuits. Troubleshooting procedures will reference 24-Vdc measurement, however the value can vary. When the batteries are fully charged, 25.2-Vdc can be measured on an open 24-volt circuit and 29-Vdc can be measured when the engine is running at 1000 rpm.
- (a) Connect the red test lead to the Volt-Ohm input connector and the black lead to the COM input on the meter. If a DC-AC switch is present, make sure it is set to the DC position.
- (b) Set the function/range switch to the desired volts position. If the magnitude of the voltage is not known, set the switch to a range which will be able to read most voltages seen on the truck (typically, a 200V range will do). Then reduce the range until a satisfactory reading is obtained.

b. General Wire Test Procedures. M1120 troubleshooting isolates problems down to the components that could cause a specific failure. When all of the components in a circuit are tested without isolating a fault, the wires are the only other components that could be suspected of being damaged. Each wire that must be tested may pass through two or more connectors. The following procedures provide general instructions for testing electrical wires. These procedures will either attempt to measure a voltage at the working end of a circuit or continuity from the power end of a specific wire to the working end. Before either of these tests are performed, all connectors in the circuit must be checked for looseness.

CAUTION

Use properly sized test leads and ensure care is used when checking for resistance, continuity or voltage at connectors or damage to equipment may result.

- (1) Wire voltage drop test.
- (a) Disconnect connector from the component (light, relay, motor, etc.) at the working end of the circuit.
- (b) Check connector terminal(s) for damage; repair or replace connector as necessary.
- (c) Set up truck conditions that will create voltage at the working end of the wire.

Organizational Maintenance Instructions (Cont)

NOTE

M1120 is equipped with 24-Vdc circuits. The troubleshooting fault that referenced these general wire tests will provide voltage information for testing wires.

- (d) Check for the required voltage at the working end of the wire.
 - 1 If the required voltage is not measured at the working end of the wire, go to step (e).
 - 2 If the required voltage is measured at the working end of the wire, the fault has not been isolated. Continue with the fault isolation tests or notify supervisor.
- (e) Disconnect the first connector in line from the working end of the wire to the power source.
- (f) Check for the required voltage at the working end of the wire.
 - 1 If the required voltage is not measured at the working end of the wire, go to step (g).
 - 2 If the required voltage is measured at the working end of the wire, a fault is in the section of wire most recently disconnected. Repair the wire and perform the voltage test again.
- (g) Repeat steps (d) and (e) until all sections of the suspect wire are tested.
- (2) Wire continuity test.
 - (a) Disconnect wire from the component (light, relay, motor, etc.) at the working end of the circuit and from the power end.
 - (b) Set up truck conditions that will create the desired circuit.
 - (c) Check continuity from power end of the wire to the working end of the wire.
 - 1 If continuity is not measured go to step (d).
 - 2 If continuity is measured, the fault has not been isolated. Continue with the fault isolation tests or notify supervisor.
 - (d) Disconnect the first connector from the working end of the wire in line to the power source.
 - (e) Check continuity.
 - 1 If continuity is not measured, go to step (f).
 - 2 If continuity is measured, a fault is in the section of the wire most recently disconnected. Repair the wire and perform the continuity test again.
 - (f) Repeat Steps (d) and (e) until all sections of the suspect wire are tested.
- (3) Wire harness shorting wires test.
 - (a) Disconnect wire harness connector with wire suspected of damage.
 - (b) Set multimeter select switch to Ohm.
 - (c) Connect positive (+) multimeter lead to harness connector terminal of the suspect wire.
 - (d) Connect negative (-) multimeter lead to each of the other terminals in the harness connector.
 - 1 If there is continuity, the suspect wire and the wire where continuity is measured are shorting together; repair wire.
 - 2 If there is no continuity, all wires are OK.
- (4) Wire repair. Refer to TM 43-0158 for detailed instructions concerning electrical wiring repairs. Wire harness repair is limited to splicing and taping of wires at Organizational Maintenance. If a wire harness cannot be repaired, notify DS Maintenance.

Organizational Maintenance Instructions (Cont)

4-18. TROUBLESHOOTING INSTRUCTIONS (CONT).

Table 4-2. Load Handling System (LHS) Fault Index

Fault No.	Description	Page
1.	LHS Indicator Does Not Operate	4-13
2.	LHS NO TRANSIT Indicator Does Not Operate	4-25
3.	LHS Over Load Indicator Does Not Operate	4-37
4.	LHS Over Load Indicator Does Not Go Out	4-46
5.	Loss Of Supply Voltage To Distribution Box	4-48
6.	Loss Of Supply Voltage To Main Junction Box	4-56
7.	LHS Circuit Breaker Does Not Operate	4-58
8.	Reverse Alarm Does Not Operate	4-59
9.	Loss Of Main Frame Safe Lowering Function	4-62
10.	Loss Of Hook Arm Safe Lowering Function	4-70
11.	LHS Does Not Operate	4-79
12.	Hook Arm Does Not Unload in Manual Mode	4-87
13.	Hook Arm Does Not Load In Manual Mode	4-97
14.	Main Frame Does Not Unload In Manual Mode	4-107
15.	Main Frame Does Not Load In Manual Mode	4-117
16.	LHS Does Not Load In Auto Mode	4-126
17.	LHS Does Not Unload In Auto Mode	4-135

Table 4-2.1. Container Handling Unit (CHU) Fault Index

Fault No.	Description	Page
1.	Main Frame Does Not Unload	4-142.1
2.	LHS-CHU Does Not Unload	4-142.2
3.	Hook Arm Extends Too Far	4-142.8
4.	Main Frame Does Not Go to Travel Position	4-142.15

Organizational Maintenance Instructions (Cont)

Table 4-3. Load Handling System (LHS) Troubleshooting

Malfunction	Test or Inspection	Corrective Action
LOAD HANDLING SYSTEM (LHS)		
1. LHS INDICATOR DOES NOT OPERATE.		
<u>WARNING</u>		
<p>Remove all jewelry such as rings, dog tags, bracelets, etc. If jewelry or tools contact positive electrical circuits, a direct short may result. Damage to equipment and injury or death to personnel may occur.</p>		
<p>Step 1. Check for continuity between terminals of LHS indicator bulb.</p>		
<p style="padding-left: 40px;">If there is no continuity, replace LHS indicator bulb.</p>		

Organizational Maintenance Instructions (Cont)

4-18. TROUBLESHOOTING INSTRUCTIONS (CONT).

Table 4-3. Load Handling System (LHS) Troubleshooting (CONT)

Malfunction	Test or Inspection	Corrective Action
LOAD HANDLING SYSTEM (LHS) (CONT)		
1. LHS INDICATOR DOES NOT OPERATE (CONT).		
<u>WARNING</u>		
<p>Remove all jewelry such as rings, dog tags, bracelets, etc. If jewelry or tools contact positive electrical circuits, a direct short may result. Damage to equipment and injury or death to personnel may occur.</p>		
Step 2.	<p>Check for 22 to 28 Vdc on wire 1722 at LHS indicator connector, with ENGINE switch ON and the hydraulic selector switch in MAN H.A. position.</p>	
	<p>If there are 22 to 28 Vdc at LHS indicator connector, go to Step 11. of this Fault.</p>	
	<p>If Vdc measurement is below specification, go to Step 3. of this Fault.</p>	

Organizational Maintenance Instructions (Cont)

Table 4-3. Load Handling System (LHS) Troubleshooting (CONT)

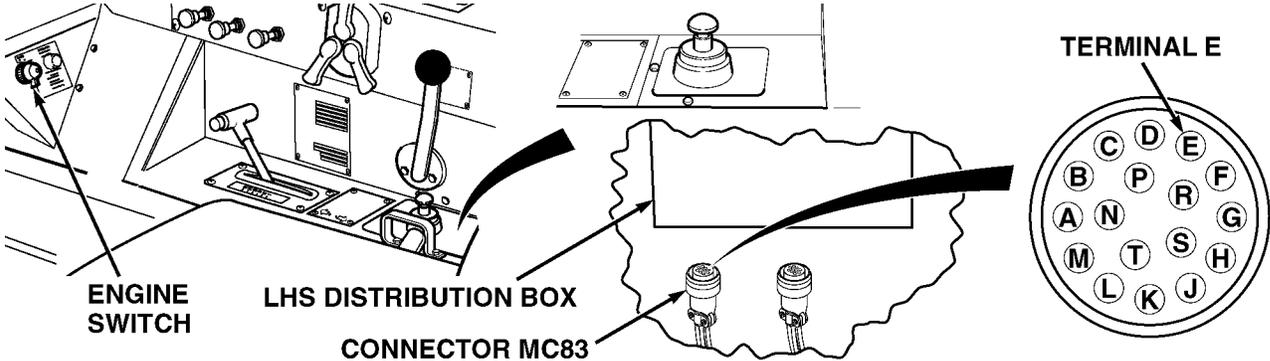
Malfunction	Test or Inspection	Corrective Action
LOAD HANDLING SYSTEM (LHS) (CONT)		
1. LHS INDICATOR DOES NOT OPERATE (CONT).		
 <p>The diagram illustrates the electrical components for the LHS indicator. On the left, the engine switch is shown. In the center, the LHS distribution box is connected to connector MC83. On the right, a circular terminal block for connector MC83 is shown with terminals labeled A through S. Terminal E is specifically highlighted with an arrow and the label 'TERMINAL E'.</p>		
<u>WARNING</u>		
<p>Remove all jewelry such as rings, dog tags, bracelets, etc. If jewelry or tools contact positive electrical circuits, a direct short may result. Damage to equipment and injury or death to personnel may occur.</p>		
Step 3.	<p>Check for 22 to 28 Vdc on wire 1755 at connector MC83 terminal E with ENGINE switch in ON position.</p>	
	<p>If Vdc measurement is below specification, repair wire 1755 or notify DS Maintenance.</p>	

Organizational Maintenance Instructions (Cont)

4-18. TROUBLESHOOTING INSTRUCTIONS (CONT).

Table 4-3. Load Handling System (LHS) Troubleshooting (CONT)

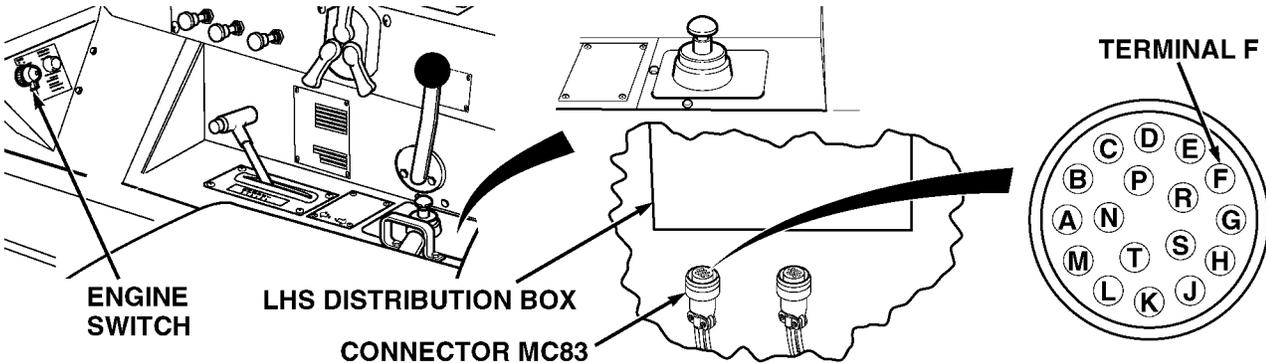
Malfunction	Test or Inspection	Corrective Action
LOAD HANDLING SYSTEM (LHS) (CONT)		
1. LHS INDICATOR DOES NOT OPERATE (CONT).		
 <p>The diagram illustrates the electrical components for the LHS indicator. On the left, an engine switch is shown. In the center, the LHS distribution box is connected to connector MC83. On the right, a circular terminal block is shown with terminals labeled A through S. Terminal F is specifically highlighted with an arrow and the label 'TERMINAL F'.</p>		
<u>WARNING</u>		
<p>Remove all jewelry such as rings, dog tags, bracelets, etc. If jewelry or tools contact positive electrical circuits, a direct short may result. Damage to equipment and injury or death to personnel may occur.</p>		
Step 4.	<p>Check for continuity on wire 1435 at harness connector MC83 terminal F and chassis ground.</p>	<p>If Vdc measurement is below specification, repair wire 1435 or notify DS Maintenance.</p>

Organizational Maintenance Instructions (Cont)

Table 4-3. Load Handling System (LHS) Troubleshooting (CONT)

Malfunction	Test or Inspection	Corrective Action
LOAD HANDLING SYSTEM (LHS) (CONT)		
1. LHS INDICATOR DOES NOT OPERATE (CONT).		
<p>The diagram illustrates the electrical connections for the LHS indicator. It shows a side panel with a joystick and various controls. A terminal block with terminals A through F is connected to the system. A connector MC94 is shown with a terminal D. A terminal M is also indicated. The LHS distribution box contains connector MC83. A circular terminal block diagram shows terminals A through S arranged in a circle.</p>		
<u>WARNING</u>		
<p>Remove all jewelry such as rings, dog tags, bracelets, etc. If jewelry or tools contact positive electrical circuits, a direct short may result. Damage to equipment and injury or death to personnel may occur.</p>		
Step 5.	<p>Check for continuity on wire 1488 at harness connector MC83 terminal M and harness connector MC94 terminal D.</p>	<p>If there is no continuity, repair wire 1488 or notify DS Maintenance.</p>

Organizational Maintenance Instructions (Cont)

4-18. TROUBLESHOOTING INSTRUCTIONS (CONT).

Table 4-3. Load Handling System (LHS) Troubleshooting (CONT)

Malfunction	Test or Inspection	Corrective Action
LOAD HANDLING SYSTEM (LHS) (CONT)		
1. LHS INDICATOR DOES NOT OPERATE (CONT).		
<u>WARNING</u>		
<p>Remove all jewelry such as rings, dog tags, bracelets, etc. If jewelry or tools contact positive electrical circuits, a direct short may result. Damage to equipment and injury or death to personnel may occur.</p>		
Step 6.	<p>Check for 22 to 28 Vdc on wire 1488 at harness connector MC94 terminal D with ENGINE switch in ON position.</p>	<p>If Vdc measurement is below specification, turn ENGINE switch to OFF position and replace LHS distribution box (Para 4-34).</p>

Organizational Maintenance Instructions (Cont)

Table 4-3. Load Handling System (LHS) Troubleshooting (CONT)

Malfunction	Test or Inspection	Corrective Action
LOAD HANDLING SYSTEM (LHS) (CONT)		
1. LHS INDICATOR DOES NOT OPERATE (CONT).		
WARNING		
<p>Remove all jewelry such as rings, dog tags, bracelets, etc. If jewelry or tools contact positive electrical circuits, a direct short may result. Damage to equipment and injury or death to personnel may occur.</p>		
Step 7.	<p>Check for continuity at hydraulic selector switch harness connector MC93 terminal E and harness connector MC94 terminal D with switch in the MAN H.A., MAN M.F., and AUTO positions.</p>	<p>If there is no continuity, replace hydraulic selector switch (Para 4-31).</p>

Organizational Maintenance Instructions (Cont)

4-18. TROUBLESHOOTING INSTRUCTIONS (CONT).

Table 4-3. Load Handling System (LHS) Troubleshooting (CONT)

Malfunction	Test or Inspection	Corrective Action
LOAD HANDLING SYSTEM (LHS) (CONT)		
1. LHS INDICATOR DOES NOT OPERATE (CONT).		
<u>WARNING</u>		
<p>Remove all jewelry such as rings, dog tags, bracelets, etc. If jewelry or tools contact positive electrical circuits, a direct short may result. Damage to equipment and injury or death to personnel may occur.</p>		
Step 8.	<p>Check for continuity on wire 1483 at connector MC83 terminal G and harness connector MC93 terminal E.</p>	<p>If there is no continuity, repair wire 1483 or notify DS Maintenance.</p>

Organizational Maintenance Instructions (Cont)

Table 4-3. Load Handling System (LHS) Troubleshooting (CONT)

Malfunction	Test or Inspection	Corrective Action
LOAD HANDLING SYSTEM (LHS) (CONT)		
1. LHS INDICATOR DOES NOT OPERATE (CONT).		
<p>The diagram illustrates the electrical connection between the LHS distribution box, a central unit, and the MC83 connector. The LHS distribution box is shown on the left, connected to a central rectangular unit. This unit is further connected to a circular MC83 connector. The connector has 12 terminals labeled A through M. Two terminals, G and K, are specifically identified with arrows and labels.</p>		
<u>WARNING</u>		
<p>Remove all jewelry such as rings, dog tags, bracelets, etc. If jewelry or tools contact positive electrical circuits, a direct short may result. Damage to equipment and injury or death to personnel may occur.</p>		
<p>Step 9. Check for continuity at LHS distribution box connector MC83 terminals G and K.</p>		
<p style="padding-left: 40px;">If there is no continuity, replace LHS distribution box (Para 4-34).</p>		

Organizational Maintenance Instructions (Cont)

4-18. TROUBLESHOOTING INSTRUCTIONS (CONT).

Table 4-3. Load Handling System (LHS) Troubleshooting (CONT)

Malfunction	Test or Inspection	Corrective Action
-------------	--------------------	-------------------

LOAD HANDLING SYSTEM (LHS) (CONT)

1. LHS INDICATOR DOES NOT OPERATE (CONT).

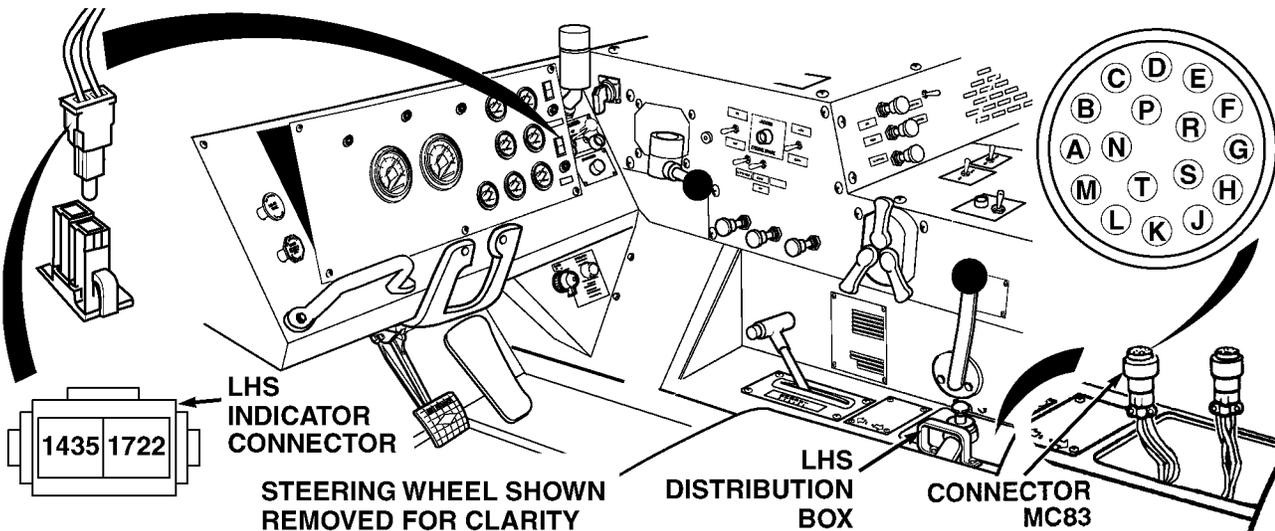

WARNING

Remove all jewelry such as rings, dog tags, bracelets, etc. If jewelry or tools contact positive electrical circuits, a direct short may result. Damage to equipment and injury or death to personnel may occur.

Step 10. Check for continuity on LHS indicator connector wire 1722 and harness connector MC83 terminal K.

If there is no continuity, repair wire 1722 or notify DS Maintenance.

Organizational Maintenance Instructions (Cont)

Table 4-3. Load Handling System (LHS) Troubleshooting (CONT)

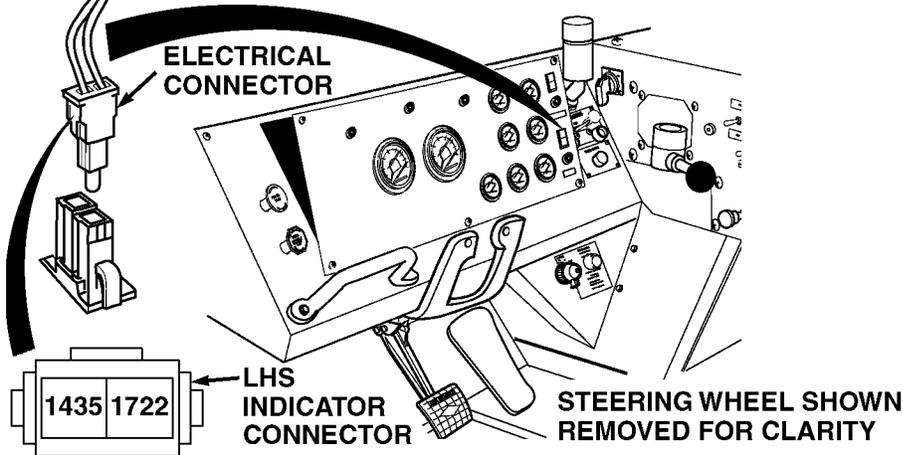
Malfunction	Test or Inspection	Corrective Action
LOAD HANDLING SYSTEM (LHS) (CONT)		
1. LHS INDICATOR DOES NOT OPERATE (CONT).		
 <p>The diagram shows a steering wheel assembly with various gauges and controls. A thick black arrow points from an 'ELECTRICAL CONNECTOR' on the left to a 'LHS INDICATOR CONNECTOR' on the right. The indicator connector is a rectangular component with two terminals labeled '1435' and '1722'. A note at the bottom right of the diagram states 'STEERING WHEEL SHOWN REMOVED FOR CLARITY'.</p>		
<u>WARNING</u>		
<p>Remove all jewelry such as rings, dog tags, bracelets, etc. If jewelry or tools contact positive electrical circuits, a direct short may result. Damage to equipment and injury or death to personnel may occur.</p>		
<p>Step 11. Check for continuity on LHS indicator connector wire 1435 and chassis ground.</p>		
<p style="padding-left: 40px;">If there is no continuity, repair wire 1435 or notify DS Maintenance.</p>		

Organizational Maintenance Instructions (Cont)

4-18. TROUBLESHOOTING INSTRUCTIONS (CONT).

Table 4-3. Load Handling System (LHS) Troubleshooting (CONT)

Malfunction	Test or Inspection	Corrective Action
LOAD HANDLING SYSTEM (LHS) (CONT)		
1. LHS INDICATOR DOES NOT OPERATE (CONT).		
Step 12. Check LHS indicator operation.		
If LHS indicator does not operate, fault not corrected. Notify DS Maintenance.		

Organizational Maintenance Instructions (Cont)

Table 4-3. Load Handling System (LHS) Troubleshooting (CONT)

Malfunction	Test or Inspection	Corrective Action
LOAD HANDLING SYSTEM (LHS) (CONT)		
2. LHS NO TRANSIT INDICATOR DOES NOT OPERATE.		
<p>The diagram illustrates the location of the LHS NO TRANSIT indicator bulb. On the left, an 'INSTRUMENT PANEL' is shown with a 'STEERING WHEEL SHOWN REMOVED FOR CLARITY'. An arrow points from a terminal on the panel to an 'ELECTRICAL CONNECTOR' with multiple wires. Another arrow points from this connector to a 'SOCKET', which is then connected to the 'LHS NO TRANSIT INDICATOR BULB'.</p>		
<u>WARNING</u>		
<p>Remove all jewelry such as rings, dog tags, bracelets, etc. If jewelry or tools contact positive electrical circuits, a direct short may result. Damage to equipment and injury or death to personnel may occur.</p>		
<p>Step 1. Check for continuity between terminals of LHS NO TRANSIT indicator bulb. If there is no continuity, replace LHS NO TRANSIT indicator bulb.</p>		

Organizational Maintenance Instructions (Cont)

4-18. TROUBLESHOOTING INSTRUCTIONS (CONT).

Table 4-3. Load Handling System (LHS) Troubleshooting (CONT)

Malfunction	Test or Inspection	Corrective Action
LOAD HANDLING SYSTEM (LHS) (CONT)		
2. LHS NO TRANSIT INDICATOR DOES NOT OPERATE (CONT).		
<p>The diagram illustrates the electrical setup for the LHS NO TRANSIT indicator. It shows a steering wheel (removed for clarity), an engine switch, and an electrical connector with wires. A separate connector block is shown with terminals labeled 1435 and 1725.</p>		
<u>WARNING</u>		
<ul style="list-style-type: none"> • Keep clear of equipment when equipment is being raised or lowered. Equipment may fall and cause serious injury or death to personnel. • Remove all jewelry such as rings, dog tags, bracelets, etc. If jewelry or tools contact positive electrical circuits, a direct short may result. Damage to equipment and injury or death to personnel may occur. 		
Step 2.	Check for 22 to 28 Vdc on wire 1725 at LHS NO TRANSIT indicator connector with ENGINE switch in ON position and LHS raised.	
	If there are 22 to 28 Vdc at indicator connector, go to Step 11. of this Fault.	
	If Vdc measurement is below specification, go to Step 3. of this Fault.	

Organizational Maintenance Instructions (Cont)

Table 4-3. Load Handling System (LHS) Troubleshooting (CONT)

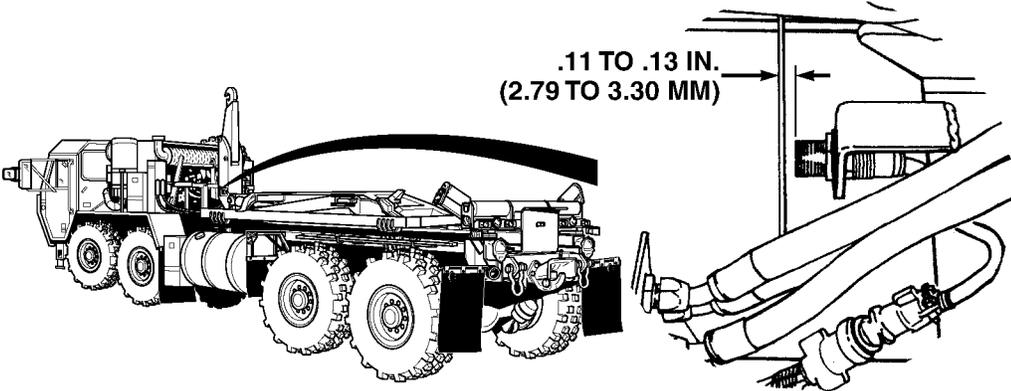
Malfunction	Test or Inspection	Corrective Action
LOAD HANDLING SYSTEM (LHS) (CONT)		
2. LHS NO TRANSIT INDICATOR DOES NOT OPERATE (CONT).		
		
<u>WARNING</u>		
<p>Keep clear of equipment when equipment is being raised or lowered. Equipment may fall and cause serious injury or death to personnel.</p>		
<p>Step 3. Check clearance between proximity switch and hook arm.</p>		
<p style="padding-left: 40px;">If clearance is more than .13 in (3.30 mm) or less than .11 in. (2.79 mm), adjust proximity switch (Para 4-35).</p>		

Organizational Maintenance Instructions (Cont)

4-18. TROUBLESHOOTING INSTRUCTIONS (CONT).

Table 4-3. Load Handling System (LHS) Troubleshooting (CONT)

Malfunction	Test or Inspection	Corrective Action
LOAD HANDLING SYSTEM (LHS) (CONT)		
2. LHS NO TRANSIT INDICATOR DOES NOT OPERATE (CONT).		
<p>The diagram illustrates the electrical connection for terminal 9. At the top, a row of 18 terminals is shown, numbered 1 through 18. Terminal 9 is specifically labeled. Below this, a side view of a truck is shown with an arrow pointing from terminal 9 to a detailed view of the 'MAIN JUNCTION BOX' on the right. The junction box is shown with its cover open, revealing internal wiring and components.</p>		
<u>WARNING</u>		
<p>Remove all jewelry such as rings, dog tags, bracelets, etc. If jewelry or tools contact positive electrical circuits, a direct short may result. Damage to equipment and injury or death to personnel may occur.</p>		
<u>CAUTION</u>		
<p>When opening the main junction box, do not pull or allow front of junction box to hang by the wire connections. Failure to comply will damage the wire connections.</p>		
<u>NOTE</u>		
<p>Only remove center screw on engine side of LHS main junction box cover.</p>		
Step 4.	Check for 22 to 28 Vdc at main junction box terminal 9.	
	If Vdc measurement is below specification, go to Step 1. of Fault 6.	

Organizational Maintenance Instructions (Cont)

Table 4-3. Load Handling System (LHS) Troubleshooting (CONT)

Malfunction	Test or Inspection	Corrective Action
LOAD HANDLING SYSTEM (LHS) (CONT)		
2. LHS NO TRANSIT INDICATOR DOES NOT OPERATE (CONT).		
<u>WARNING</u>		
<p>Remove all jewelry such as rings, dog tags, bracelets, etc. If jewelry or tools contact positive electrical circuits, a direct short may result. Damage to equipment and injury or death to personnel may occur.</p>		
Step 5.	<p>Check for 22 to 28 Vdc on wire 1472 at harness connector MC88 terminal A with ENGINE switch in ON position.</p>	
	<p>If Vdc measurement is below specification, turn ENGINE switch to OFF position and repair wire 1472 or notify DS Maintenance.</p>	

Organizational Maintenance Instructions (Cont)

4-18. TROUBLESHOOTING INSTRUCTIONS (CONT).

Table 4-3. Load Handling System (LHS) Troubleshooting (CONT)

Malfunction	Test or Inspection	Corrective Action
LOAD HANDLING SYSTEM (LHS) (CONT)		
2. LHS NO TRANSIT INDICATOR DOES NOT OPERATE (CONT).		
<p>The diagram illustrates the electrical connection for the LHS transit indicator. On the left, a circular terminal block contains three terminals labeled A, B, and C. Terminal C is indicated by an arrow and labeled 'TERMINAL C'. A thick black line representing a wire connects terminal C to a 'CONNECTOR MC88'. This connector is shown in a detailed view of the vehicle's chassis and LHS components. A side-view illustration of the vehicle shows the LHS system mounted on the chassis, with a thick black line representing the wire connecting it to the terminal block.</p>		
<u>WARNING</u>		
<p>Remove all jewelry such as rings, dog tags, bracelets, etc. If jewelry or tools contact positive electrical circuits, a direct short may result. Damage to equipment and injury or death to personnel may occur.</p>		
<p>Step 6. Check for continuity on wire 1435 at harness connector MC88 terminal C and chassis ground.</p>		
<p style="padding-left: 40px;">If there is no continuity, repair wire 1435 or notify DS Maintenance.</p>		

Organizational Maintenance Instructions (Cont)

Table 4-3. Load Handling System (LHS) Troubleshooting (CONT)

Malfunction	Test or Inspection	Corrective Action
LOAD HANDLING SYSTEM (LHS) (CONT)		
2. LHS NO TRANSIT INDICATOR DOES NOT OPERATE (CONT).		
<p>The diagram illustrates the electrical connections for the LHS. It shows a truck chassis with a cable connecting to a harness connector MC88. This connector has three terminals labeled A, B, and C. Terminal B is specifically highlighted. Another part of the diagram shows a harness connector MC81 with two terminals, one of which is labeled as terminal M. A circular terminal layout diagram shows terminals A through S arranged in a circle. Labels include 'LHS DISTRIBUTION BOX', 'CONNECTOR MC81', 'CONNECTOR MC88', and 'TERMINAL B'.</p>		
<u>WARNING</u>		
<p>Remove all jewelry such as rings, dog tags, bracelets, etc. If jewelry or tools contact positive electrical circuits, a direct short may result. Damage to equipment and injury or death to personnel may occur.</p>		
Step 7.	<p>Check for continuity on wire 1471 at harness connector MC88 terminal B and chassis ground with harness connector MC81 terminal M jumpered to ground.</p>	
<p>If there is no continuity, repair wire 1471 or notify DS Maintenance.</p>		

Organizational Maintenance Instructions (Cont)

4-18. TROUBLESHOOTING INSTRUCTIONS (CONT).

Table 4-3. Load Handling System (LHS) Troubleshooting (CONT)

Malfunction	Test or Inspection	Corrective Action
LOAD HANDLING SYSTEM (LHS) (CONT)		
2. LHS NO TRANSIT INDICATOR DOES NOT OPERATE (CONT).		
<u>WARNING</u>		
<ul style="list-style-type: none"> • Remove all jewelry such as rings, dog tags, bracelets, etc. If jewelry or tools contact positive electrical circuits, a direct short may result. Damage to equipment and injury or death to personnel may occur. • Keep clear of equipment when equipment is being raised or lowered. Equipment may fall and cause serious injury or death to personnel. 		
<u>CAUTION</u>		
<p>When opening the main junction box, do not pull or allow front of junction box to hang by wire connections. Failure to comply will damage the wire connections.</p>		
Step 8.	<p>Check for 22 to 28 Vdc at main junction box terminal 11 with hook arm up and ENGINE switch in ON position.</p>	
	<p>If Vdc measurement is below specification, turn ENGINE switch to OFF position, replace proximity switch (Para 4-35).</p>	

Organizational Maintenance Instructions (Cont)

Table 4-3. Load Handling System (LHS) Troubleshooting (CONT)

Malfunction	Test or Inspection	Corrective Action																																						
LOAD HANDLING SYSTEM (LHS) (CONT)																																								
2. LHS NO TRANSIT INDICATOR DOES NOT OPERATE (CONT).																																								
		<table border="1"> <tr> <td><input type="checkbox"/></td> <td>AUTO LOAD IN</td> </tr> <tr> <td><input type="checkbox"/></td> <td>AUTO UNLOAD IN</td> </tr> <tr> <td><input type="checkbox"/></td> <td>MAN/AUTO MODE</td> </tr> <tr> <td><input type="checkbox"/></td> <td>MAN TRANSIT IN</td> </tr> <tr> <td><input type="checkbox"/></td> <td>UNLOAD OUT</td> </tr> <tr> <td><input type="checkbox"/></td> <td>LOAD OUT</td> </tr> <tr> <td><input type="checkbox"/></td> <td>AUX MODE IN</td> </tr> <tr> <td><input type="checkbox"/></td> <td>NO TRANSIT LIGHT</td> </tr> <tr> <td><input type="checkbox"/></td> <td>OVERLOAD LIGHT</td> </tr> <tr> <td><input type="checkbox"/></td> <td>HOOK ARM "A" SOL</td> </tr> <tr> <td><input type="checkbox"/></td> <td>MAIN RAM "B" SOL</td> </tr> <tr> <td><input type="checkbox"/></td> <td>HOOK ARM "B" SOL</td> </tr> <tr> <td><input type="checkbox"/></td> <td>MAIN RAM "A" SOL</td> </tr> <tr> <td><input type="checkbox"/></td> <td>+24V IN</td> </tr> <tr> <td><input type="checkbox"/></td> <td>HOOK ARM UP</td> </tr> <tr> <td><input type="checkbox"/></td> <td>FREE FLOW VALVE</td> </tr> <tr> <td><input type="checkbox"/></td> <td>HOOK ARM DOWN</td> </tr> <tr> <td><input type="checkbox"/></td> <td>TRANSIT VALVE</td> </tr> <tr> <td><input type="checkbox"/></td> <td>OVERLOAD IN</td> </tr> </table>	<input type="checkbox"/>	AUTO LOAD IN	<input type="checkbox"/>	AUTO UNLOAD IN	<input type="checkbox"/>	MAN/AUTO MODE	<input type="checkbox"/>	MAN TRANSIT IN	<input type="checkbox"/>	UNLOAD OUT	<input type="checkbox"/>	LOAD OUT	<input type="checkbox"/>	AUX MODE IN	<input type="checkbox"/>	NO TRANSIT LIGHT	<input type="checkbox"/>	OVERLOAD LIGHT	<input type="checkbox"/>	HOOK ARM "A" SOL	<input type="checkbox"/>	MAIN RAM "B" SOL	<input type="checkbox"/>	HOOK ARM "B" SOL	<input type="checkbox"/>	MAIN RAM "A" SOL	<input type="checkbox"/>	+24V IN	<input type="checkbox"/>	HOOK ARM UP	<input type="checkbox"/>	FREE FLOW VALVE	<input type="checkbox"/>	HOOK ARM DOWN	<input type="checkbox"/>	TRANSIT VALVE	<input type="checkbox"/>	OVERLOAD IN
<input type="checkbox"/>	AUTO LOAD IN																																							
<input type="checkbox"/>	AUTO UNLOAD IN																																							
<input type="checkbox"/>	MAN/AUTO MODE																																							
<input type="checkbox"/>	MAN TRANSIT IN																																							
<input type="checkbox"/>	UNLOAD OUT																																							
<input type="checkbox"/>	LOAD OUT																																							
<input type="checkbox"/>	AUX MODE IN																																							
<input type="checkbox"/>	NO TRANSIT LIGHT																																							
<input type="checkbox"/>	OVERLOAD LIGHT																																							
<input type="checkbox"/>	HOOK ARM "A" SOL																																							
<input type="checkbox"/>	MAIN RAM "B" SOL																																							
<input type="checkbox"/>	HOOK ARM "B" SOL																																							
<input type="checkbox"/>	MAIN RAM "A" SOL																																							
<input type="checkbox"/>	+24V IN																																							
<input type="checkbox"/>	HOOK ARM UP																																							
<input type="checkbox"/>	FREE FLOW VALVE																																							
<input type="checkbox"/>	HOOK ARM DOWN																																							
<input type="checkbox"/>	TRANSIT VALVE																																							
<input type="checkbox"/>	OVERLOAD IN																																							
<u>WARNING</u>																																								
<ul style="list-style-type: none"> • Keep clear of equipment when equipment is being raised or lowered. Equipment may fall and cause serious injury or death to personnel. • Remove all jewelry such as rings, dog tags, bracelets, etc. If jewelry or tools contact positive electrical circuits, a direct short may result. Damage to equipment and injury or death to personnel may occur. 																																								
<u>NOTE</u>																																								
<p>LHS distribution box harness connectors can be inserted up through opening in cab, then reconnected to distribution box to perform test.</p>																																								
Step 9.	Check for appropriate LHS distribution box indicator lights to operate.																																							
	<p>If appropriate indicator lights do not operate, replace the LHS distribution box (Para 4-34).</p>																																							

Organizational Maintenance Instructions (Cont)

4-18. TROUBLESHOOTING INSTRUCTIONS (CONT).

Table 4-3. Load Handling System (LHS) Troubleshooting (CONT)

Malfunction	Test or Inspection	Corrective Action
LOAD HANDLING SYSTEM (LHS) (CONT)		
2. LHS NO TRANSIT INDICATOR DOES NOT OPERATE (CONT).		
<u>WARNING</u>		
<p>Remove all jewelry such as rings, dog tags, bracelets, etc. If jewelry or tools contact positive electrical circuits, a direct short may result. Damage to equipment and injury or death to personnel may occur.</p>		
<p>Step 10. Check for continuity on wire 1725 at harness connector MC83 terminal S and LHS NO TRANSIT indicator harness connector.</p>		
<p>If there is no continuity, repair wire 1725 or notify DS Maintenance.</p>		

Organizational Maintenance Instructions (Cont)

Table 4-3. Load Handling System (LHS) Troubleshooting (CONT)

Malfunction	Test or Inspection	Corrective Action
LOAD HANDLING SYSTEM (LHS) (CONT)		
2. LHS NO TRANSIT INDICATOR DOES NOT OPERATE (CONT).		
<p>The diagram illustrates the electrical setup for the LHS NO TRANSIT indicator. On the left, a steering wheel control panel is shown with the steering wheel removed for clarity. A thick black arrow points from a terminal on the panel to an electrical connector. Another thick black arrow points from the electrical connector to a socket. A separate LHS NO TRANSIT indicator bulb is shown next to the socket. Below the main diagram, a connector block is shown with two terminals labeled 1435 and 1725.</p>		
WARNING		
<p>Remove all jewelry such as rings, dog tags, bracelets, etc. If jewelry or tools contact positive electrical circuits, a direct short may result. Damage to equipment and injury or death to personnel may occur.</p>		
<p>Step 11. Check for continuity on wire 1435 at LHS NO TRANSIT indicator connector and chassis ground.</p>		
<p>If there is no continuity, repair wire 1435 or notify DS Maintenance.</p>		

Organizational Maintenance Instructions (Cont)

4-18. TROUBLESHOOTING INSTRUCTIONS (CONT).

Table 4-3. Load Handling System (LHS) Troubleshooting (CONT)

Malfunction	Test or Inspection	Corrective Action
LOAD HANDLING SYSTEM (LHS) (CONT)		
2. LHS NO TRANSIT INDICATOR DOES NOT OPERATE (CONT).		
<u>WARNING</u>		
<p>Keep clear of equipment when equipment is being raised or lowered. Equipment may fall and cause serious injury to death to personnel.</p>		
<p>Step 12. Check LHS NO TRANSIT indicator operation.</p>		
<p style="padding-left: 40px;">If LHS NO TRANSIT indicator does not operate, fault not corrected. Notify DS Maintenance.</p>		

Organizational Maintenance Instructions (Cont)

Table 4-3. Load Handling System (LHS) Troubleshooting (CONT)

Malfunction	Test or Inspection	Corrective Action
LOAD HANDLING SYSTEM (LHS) (CONT)		
3. LHS OVER LOAD INDICATOR DOES NOT OPERATE.		
<p>The diagram illustrates the electrical connection for the LHS over load indicator. On the left, an instrument panel is shown with a steering wheel removed for clarity. An arrow points from a terminal on the panel to an electrical connector. This connector is linked to a socket, which is in turn connected to the LHS over load indicator bulb.</p>		
<u>WARNING</u>		
<p>Remove all jewelry such as rings, dog tags, bracelets, etc. If jewelry or tools contact positive electrical circuits, a direct short may result. Damage to equipment and injury or death to personnel may occur.</p>		
<p>Step 1. Check for continuity between terminals of LHS OVER LOAD indicator bulb. If there is no continuity, replace LHS OVER LOAD indicator bulb.</p>		

Organizational Maintenance Instructions (Cont)

4-18. TROUBLESHOOTING INSTRUCTIONS (CONT).

Table 4-3. Load Handling System (LHS) Troubleshooting (CONT)

Malfunction	Test or Inspection	Corrective Action
LOAD HANDLING SYSTEM (LHS) (CONT)		
3. LHS OVER LOAD INDICATOR DOES NOT OPERATE (CONT).		
<u>WARNING</u>		
<p>Remove all jewelry such as rings, dog tags, bracelets, etc. If jewelry or tools contact positive electrical circuits, a direct short may result. Damage to equipment and injury or death to personnel may occur.</p>		
Step 2.	<p>Check for 22 to 28 Vdc on wire 1726 at LHS OVER LOAD indicator with LHS in transit position and joystick held in LOAD position and then released.</p>	
<p>If there are 22 to 28 Vdc on wire 1726 go to Step 9. of this Fault.</p>		

Organizational Maintenance Instructions (Cont)

Table 4-3. Load Handling System (LHS) Troubleshooting (CONT)

Malfunction	Test or Inspection	Corrective Action
LOAD HANDLING SYSTEM (LHS) (CONT)		
3. LHS OVER LOAD INDICATOR DOES NOT OPERATE (CONT).		
<u>WARNING</u>		
<p>Remove all jewelry such as rings, dog tags, bracelets, etc. If jewelry or tools contact positive electrical circuits, a direct short may result. Damage to equipment and injury or death to personnel may occur.</p>		
<u>CAUTION</u>		
<p>When opening the main junction box, do not pull or allow front of junction box to hang by the wire connections. Failure to comply will damage the wire connections.</p>		
<u>NOTE</u>		
<p>Only remove center screw on engine side of LHS main junction box cover.</p>		
Step 3.	<p>Check for 22 to 28 Vdc at main junction box terminal 9 with ENGINE switch in ON position.</p>	<p>If Vdc measurement is below specification, go to Step 1. of Fault 6.</p>

Organizational Maintenance Instructions (Cont)

4-18. TROUBLESHOOTING INSTRUCTIONS (CONT).

Table 4-3. Load Handling System (LHS) Troubleshooting (CONT)

Malfunction	Test or Inspection	Corrective Action
LOAD HANDLING SYSTEM (LHS) (CONT)		
3. LHS OVER LOAD INDICATOR DOES NOT OPERATE (CONT).		
<u>WARNING</u>		
<p>Remove all jewelry such as rings, dog tags, bracelets, etc. If jewelry or tools contact positive electrical circuits, a direct short may result. Damage to equipment and injury or death to personnel may occur.</p>		
Step 4.	<p>Check for 22 to 28 Vdc on wire 1479 at overload differential pressure switch harness connector terminal 2 with ENGINE switch in ON position.</p>	<p>If Vdc measurement is below specification, turn ENGINE switch to OFF position and repair wire 1479 or notify DS Maintenance.</p>

Organizational Maintenance Instructions (Cont)

Table 4-3. Load Handling System (LHS) Troubleshooting (CONT)

Malfunction	Test or Inspection	Corrective Action
LOAD HANDLING SYSTEM (LHS) (CONT)		
3. LHS OVER LOAD INDICATOR DOES NOT OPERATE (CONT).		
<u>WARNING</u>		
<p>Remove all jewelry such as rings, dog tags, bracelets, etc. If jewelry or tools contact positive electrical circuits, a direct short may result. Damage to equipment and injury or death to personnel may occur.</p>		
<p>Step 5. Check continuity on wire 1460 at overload pressure switch harness connector terminal 1 with harness connector MC81 terminal N jumpered to ground.</p>		
<p style="padding-left: 40px;">If there is no continuity, remove jumperwire from harness connector MC81 to ground and repair wire 1460 or notify DS Maintenance.</p>		

Organizational Maintenance Instructions (Cont)

4-18. TROUBLESHOOTING INSTRUCTIONS (CONT).

Table 4-3. Load Handling System (LHS) Troubleshooting (CONT)

Malfunction	Test or Inspection	Corrective Action
-------------	--------------------	-------------------

LOAD HANDLING SYSTEM (LHS) (CONT)

3. LHS OVER LOAD INDICATOR DOES NOT OPERATE (CONT).

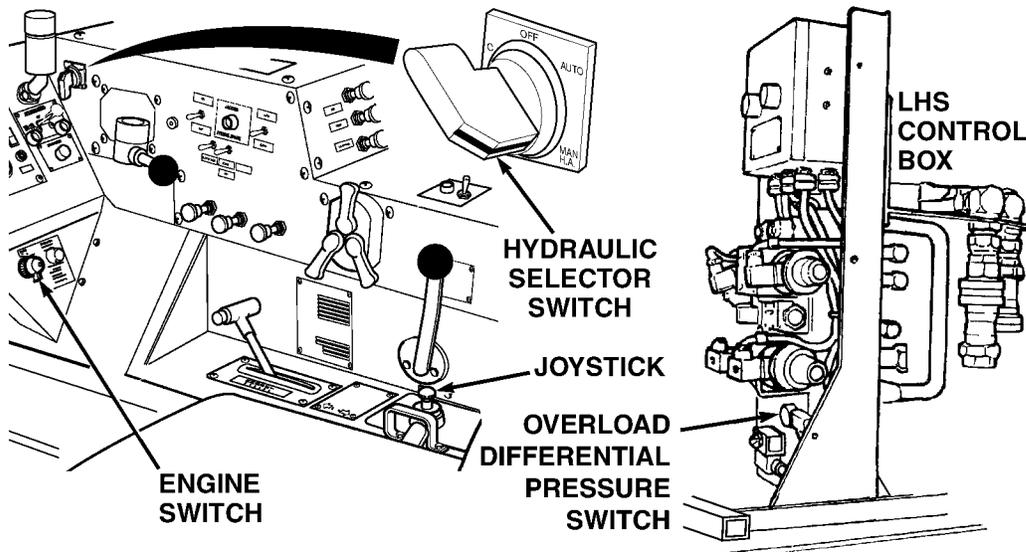

WARNING

Remove all jewelry such as rings, dog tags, bracelets, etc. If jewelry or tools contact positive electrical circuits, a direct short may result. Damage to equipment and injury or death to personnel may occur.

Step 6. With engine running and PTO engaged, check for continuity between overload differential pressure switch terminals with LHS in transit position and joystick held in LOAD position and then released.

If there is no continuity when joystick is released, notify DS Maintenance.

Organizational Maintenance Instructions (Cont)

Table 4-3. Load Handling System (LHS) Troubleshooting (CONT)

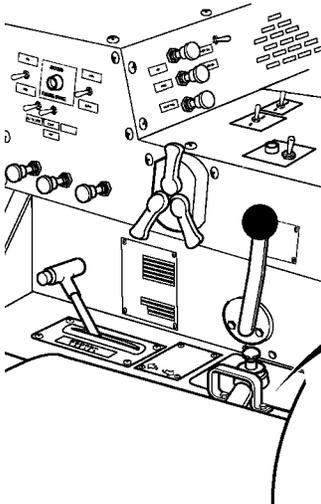
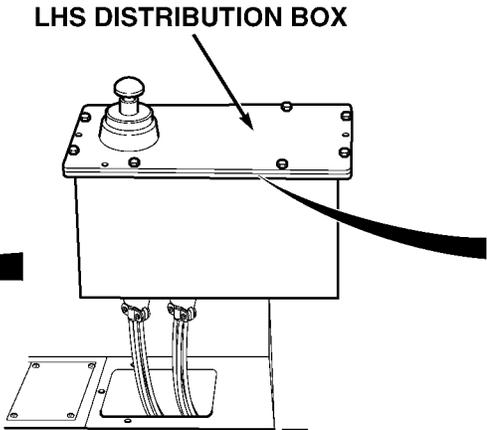
Malfunction	Test or Inspection	Corrective Action																																						
LOAD HANDLING SYSTEM (LHS) (CONT)																																								
3. LHS OVER LOAD INDICATOR DOES NOT OPERATE (CONT).																																								
	 <p style="text-align: center;">LHS DISTRIBUTION BOX</p>	<table border="1"> <tr> <td><input type="radio"/></td> <td>AUTO LOAD IN</td> </tr> <tr> <td><input type="radio"/></td> <td>AUTO UNLOAD IN</td> </tr> <tr> <td><input type="radio"/></td> <td>MAN/AUTO MODE</td> </tr> <tr> <td><input type="radio"/></td> <td>MAN TRANSIT IN</td> </tr> <tr> <td><input type="radio"/></td> <td>UNLOAD OUT</td> </tr> <tr> <td><input type="radio"/></td> <td>LOAD OUT</td> </tr> <tr> <td><input type="radio"/></td> <td>AUX MODE IN</td> </tr> <tr> <td><input type="radio"/></td> <td>NO TRANSIT LIGHT</td> </tr> <tr> <td><input type="radio"/></td> <td>OVERLOAD LIGHT</td> </tr> <tr> <td><input type="radio"/></td> <td>HOOK ARM "A" SOL</td> </tr> <tr> <td><input type="radio"/></td> <td>MAIN RAM "B" SOL</td> </tr> <tr> <td><input type="radio"/></td> <td>HOOK ARM "B" SOL</td> </tr> <tr> <td><input type="radio"/></td> <td>MAIN RAM "A" SOL</td> </tr> <tr> <td><input type="radio"/></td> <td>+24V IN</td> </tr> <tr> <td><input type="radio"/></td> <td>HOOK ARM UP</td> </tr> <tr> <td><input type="radio"/></td> <td>FREE FLOW VALVE</td> </tr> <tr> <td><input type="radio"/></td> <td>HOOK ARM DOWN</td> </tr> <tr> <td><input type="radio"/></td> <td>TRANSIT VALVE</td> </tr> <tr> <td><input type="radio"/></td> <td>OVERLOAD IN</td> </tr> </table>	<input type="radio"/>	AUTO LOAD IN	<input type="radio"/>	AUTO UNLOAD IN	<input type="radio"/>	MAN/AUTO MODE	<input type="radio"/>	MAN TRANSIT IN	<input type="radio"/>	UNLOAD OUT	<input type="radio"/>	LOAD OUT	<input type="radio"/>	AUX MODE IN	<input type="radio"/>	NO TRANSIT LIGHT	<input type="radio"/>	OVERLOAD LIGHT	<input type="radio"/>	HOOK ARM "A" SOL	<input type="radio"/>	MAIN RAM "B" SOL	<input type="radio"/>	HOOK ARM "B" SOL	<input type="radio"/>	MAIN RAM "A" SOL	<input type="radio"/>	+24V IN	<input type="radio"/>	HOOK ARM UP	<input type="radio"/>	FREE FLOW VALVE	<input type="radio"/>	HOOK ARM DOWN	<input type="radio"/>	TRANSIT VALVE	<input type="radio"/>	OVERLOAD IN
<input type="radio"/>	AUTO LOAD IN																																							
<input type="radio"/>	AUTO UNLOAD IN																																							
<input type="radio"/>	MAN/AUTO MODE																																							
<input type="radio"/>	MAN TRANSIT IN																																							
<input type="radio"/>	UNLOAD OUT																																							
<input type="radio"/>	LOAD OUT																																							
<input type="radio"/>	AUX MODE IN																																							
<input type="radio"/>	NO TRANSIT LIGHT																																							
<input type="radio"/>	OVERLOAD LIGHT																																							
<input type="radio"/>	HOOK ARM "A" SOL																																							
<input type="radio"/>	MAIN RAM "B" SOL																																							
<input type="radio"/>	HOOK ARM "B" SOL																																							
<input type="radio"/>	MAIN RAM "A" SOL																																							
<input type="radio"/>	+24V IN																																							
<input type="radio"/>	HOOK ARM UP																																							
<input type="radio"/>	FREE FLOW VALVE																																							
<input type="radio"/>	HOOK ARM DOWN																																							
<input type="radio"/>	TRANSIT VALVE																																							
<input type="radio"/>	OVERLOAD IN																																							
<u>WARNING</u>																																								
<ul style="list-style-type: none"> • Keep clear of equipment when equipment is being raised or lowered. Equipment may fall and cause serious injury or death to personnel. • Remove all jewelry such as rings, dog tags, bracelets, etc. If jewelry or tools contact positive electrical circuits, a direct short may result. Damage to equipment and injury or death to personnel may occur. 																																								
Step 7.	With engine running and PTO engaged, check for appropriate LHS distribution box indicator lights to come on.																																							
	If LHS OVER LOAD indicator is not illuminated, replace LHS distribution box (Para 4-34).																																							

Organizational Maintenance Instructions (Cont)

4-18. TROUBLESHOOTING INSTRUCTIONS (CONT).

Table 4-3. Load Handling System (LHS) Troubleshooting (CONT)

Malfunction	Test or Inspection	Corrective Action
LOAD HANDLING SYSTEM (LHS) (CONT)		
3. LHS OVER LOAD INDICATOR DOES NOT OPERATE (CONT).		
<p>The diagram illustrates the LHS control panel and steering wheel area. Key components labeled include: <ul style="list-style-type: none"> ELECTRICAL CONNECTOR: Located on the left side of the control panel. STEERING WHEEL SHOWN REMOVED FOR CLARITY: A steering wheel is shown detached from the control panel. CONNECTOR MC83: A connector located on the right side of the control panel. TERMINAL R: A specific terminal on the MC83 connector, highlighted in the circular terminal block diagram. TERMINAL BLOCK: A circular diagram showing terminals A through S, with terminal R highlighted. </p>		
<u>WARNING</u>		
<p>Remove all jewelry such as rings, dog tags, bracelets, etc. If jewelry or tools contact positive electrical circuits, a direct short may result. Damage to equipment and injury or death to personnel may occur.</p>		
Step 8.	<p>Check for continuity on LHS OVER LOAD indicator connector wire 1726 and harness connector MC83 terminal R.</p>	
<p>If there is no continuity, repair wire 1726 or notify DS Maintenance.</p>		

Organizational Maintenance Instructions (Cont)

Table 4-3. Load Handling System (LHS) Troubleshooting (CONT)

Malfunction	Test or Inspection	Corrective Action
LOAD HANDLING SYSTEM (LHS) (CONT)		
3. LHS OVER LOAD INDICATOR DOES NOT OPERATE (CONT).		
<u>WARNING</u>		
<ul style="list-style-type: none"> • Keep clear of equipment when equipment is being raised or lowered. Equipment may fall and cause serious injury or death to personnel. • Remove all jewelry such as rings, dog tags, bracelets, etc. If jewelry or tools contact positive electrical circuits, a direct short may result. Damage to equipment and injury or death to personnel may occur. 		
Step 9.	Check for continuity on wire 1435 at LHS OVER LOAD indicator connector and chassis ground.	If there is no continuity, repair wire 1435 or notify DS Maintenance.
Step 10.	Check LHS OVER LOAD indicator operation.	If LHS OVER LOAD indicator does not operate, fault not corrected. Notify DS Maintenance.

Organizational Maintenance Instructions (Cont)

4-18. TROUBLESHOOTING INSTRUCTIONS (CONT).

Table 4-3. Load Handling System (LHS) Troubleshooting (CONT)

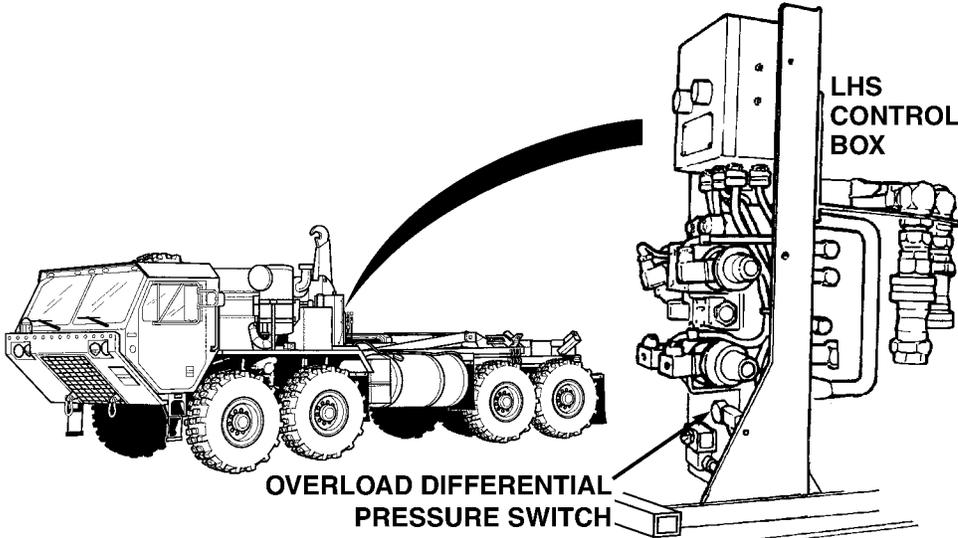
Malfunction	Test or Inspection	Corrective Action
LOAD HANDLING SYSTEM (LHS) (CONT)		
4. LHS OVER LOAD INDICATOR DOES NOT GO OUT.		
		
NOTE		
<p>Only remove center screw on engine side of LHS control box cover.</p>		
Step 1.	<p>Remove harness connector and check for continuity at overload differential pressure switch.</p>	<p>If there is no continuity, switch is OK. Replace LHS distribution box (Para 4-34).</p>
		<p>If there is continuity, overload differential pressure switch is faulty. Notify DS Maintenance.</p>

Organizational Maintenance Instructions (Cont)

Table 4-3. Load Handling System (LHS) Troubleshooting (CONT)

Malfunction	Test or Inspection	Corrective Action
LOAD HANDLING SYSTEM (LHS) (CONT)		
4. LHS OVER LOAD INDICATOR DOES NOT GO OUT (CONT).		
<u>WARNING</u>		
<p>Keep clear of equipment when equipment is being raised or lowered. Equipment may fall and cause serious injury or death to personnel.</p>		
Step 2.	Check operation of LHS OVER LOAD indicator.	<p>If LHS OVER LOAD indicator operates and fails to go out, replace LHS distribution box (Para 4-34).</p>
Step 3.	Check operation of LHS OVER LOAD indicator.	<p>If LHS OVER LOAD indicator operates and fails to go out, fault is not corrected. Notify DS Maintenance.</p>

Organizational Maintenance Instructions (Cont)

4-18. TROUBLESHOOTING INSTRUCTIONS (CONT).

Table 4-3. Load Handling System (LHS) Troubleshooting (CONT)

Malfunction	Test or Inspection	Corrective Action
-------------	--------------------	-------------------

LOAD HANDLING SYSTEM (LHS) (CONT)

5. LOSS OF SUPPLY VOLTAGE TO DISTRIBUTION BOX.

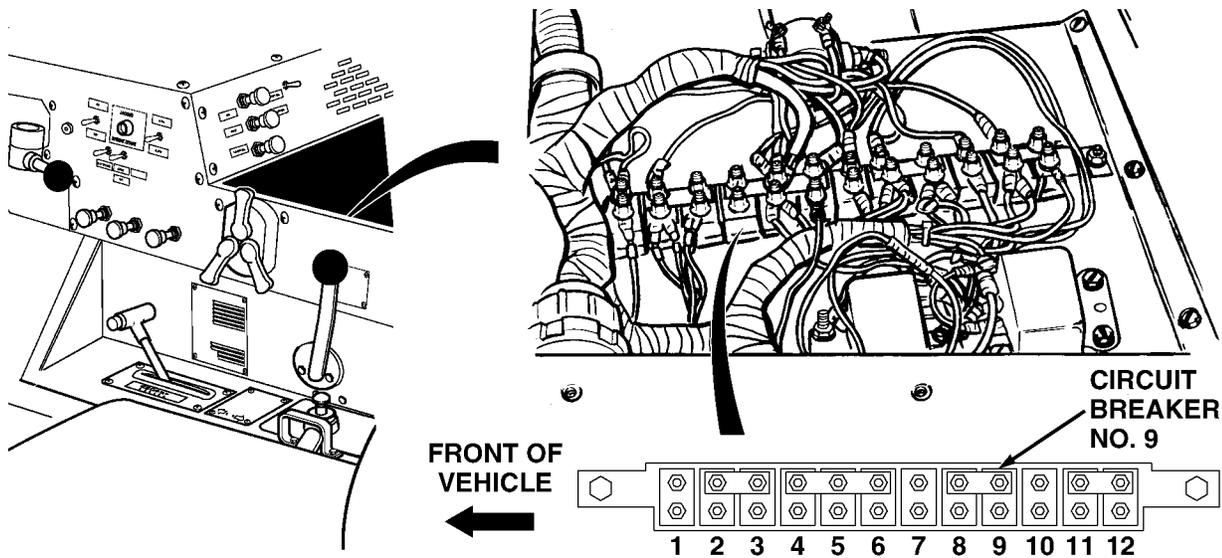

WARNING

Remove all jewelry such as rings, dog tags, bracelets, etc. If jewelry or tools contact positive electrical circuits, a direct short may result. Damage to equipment and injury or death to personnel may occur.

Step 1. Check for 22 to 28 Vdc at circuit breaker No. 9.

If Vdc measurement is below specification, refer to TM 9-2320-279-20.

Organizational Maintenance Instructions (Cont)

Table 4-3. Load Handling System (LHS) Troubleshooting (CONT)

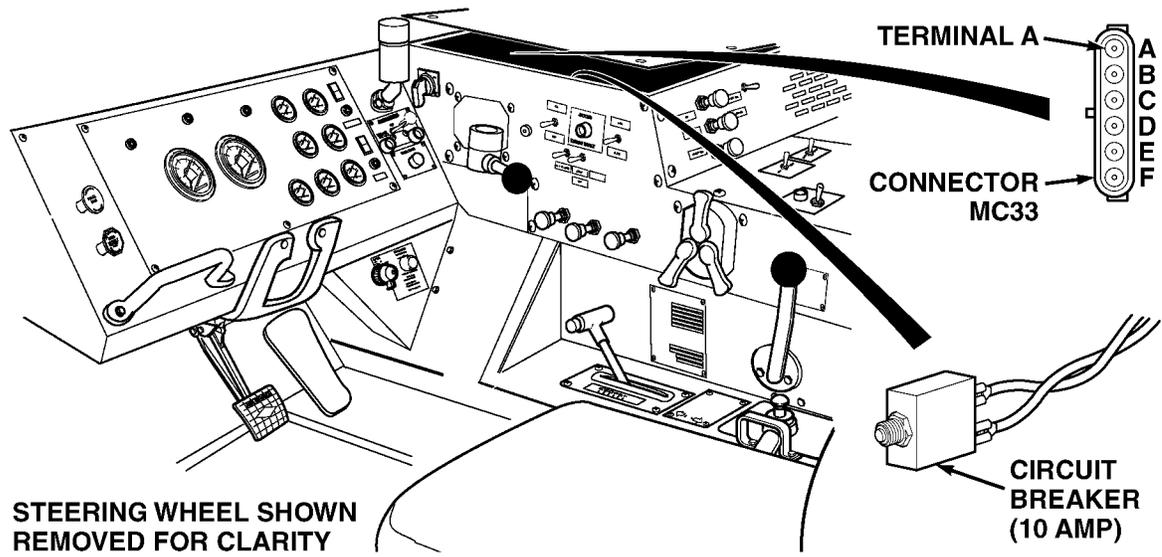
Malfunction	Test or Inspection	Corrective Action
LOAD HANDLING SYSTEM (LHS) (CONT)		
5. LOSS OF SUPPLY VOLTAGE TO DISTRIBUTION BOX (CONT).		
		
<u>WARNING</u>		
<p>Remove all jewelry such as rings, dog tags, bracelets, etc. If jewelry or tools contact positive electrical circuits, a direct short may result. Damage to equipment and injury or death to personnel may occur.</p>		
<p>Step 2. Check for 22 to 28 Vdc at harness connector MC33 terminal A.</p>		
<p>If Vdc measurement is below specification, repair wire 1755 or, replace 10 amp circuit breaker (Para 4-33), or notify DS Maintenance.</p>		

Organizational Maintenance Instructions (Cont)

4-18. TROUBLESHOOTING INSTRUCTIONS (CONT).

Table 4-3. Load Handling System (LHS) Troubleshooting (CONT)

Malfunction	Test or Inspection	Corrective Action
LOAD HANDLING SYSTEM (LHS) (CONT)		
5. LOSS OF SUPPLY VOLTAGE TO DISTRIBUTION BOX (CONT).		
<p>The diagram illustrates the electrical connection for terminal E. On the left, a circular terminal block is shown with terminals labeled A through S. Terminal E is specifically highlighted. A cable connects this terminal to a cylindrical connector labeled 'CONNECTOR MC84'. This connector is shown being plugged into the front of a large truck, which is depicted on the right side of the diagram.</p>		
<u>WARNING</u>		
<p>Remove all jewelry such as rings, dog tags, bracelets, etc. If jewelry or tools contact positive electrical circuits, a direct short may result. Damage to equipment and injury or death to personnel may occur.</p>		
Step 3.	Check for 22 to 28 Vdc at harness connector MC84 terminal E.	<p>If Vdc measurement is below specification, repair wire 1755 or notify DS Maintenance.</p>

Organizational Maintenance Instructions (Cont)

Table 4-3. Load Handling System (LHS) Troubleshooting (CONT)

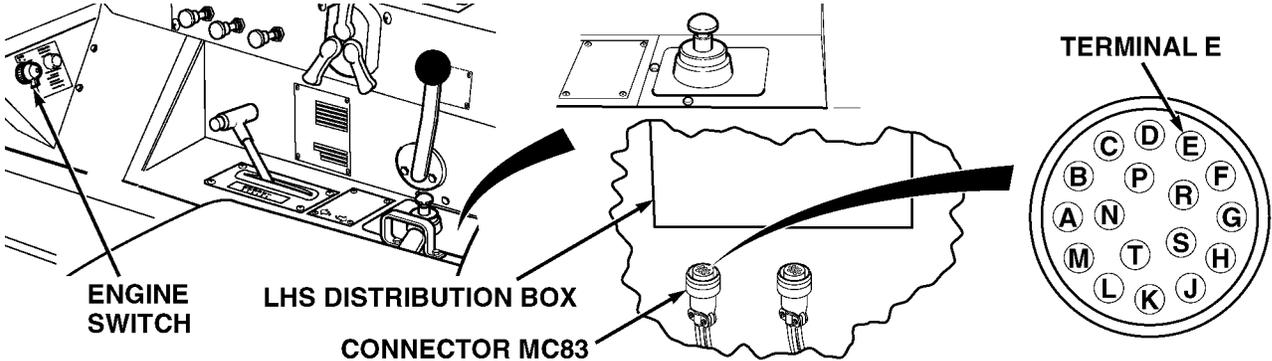
Malfunction	Test or Inspection	Corrective Action
LOAD HANDLING SYSTEM (LHS) (CONT)		
5. LOSS OF SUPPLY VOLTAGE TO DISTRIBUTION BOX (CONT).		
 <p>The diagram illustrates the electrical connection between the engine switch, the LHS distribution box, and the MC83 connector. A circular terminal block is shown with terminals labeled A through S. Terminal E is specifically highlighted with an arrow and the label 'TERMINAL E'.</p>		
<u>WARNING</u>		
<p>Remove all jewelry such as rings, dog tags, bracelets, etc. If jewelry or tools contact positive electrical circuits, a direct short may result. Damage to equipment and injury or death to personnel may occur.</p>		
<p>Step 4. Check for 22 to 28 Vdc at harness connector MC83 terminal E.</p>		
<p style="padding-left: 40px;">If Vdc measurement is below specification, repair wire 1755 or notify DS Maintenance.</p>		

Organizational Maintenance Instructions (Cont)

4-18. TROUBLESHOOTING INSTRUCTIONS (CONT).

Table 4-3. Load Handling System (LHS) Troubleshooting (CONT)

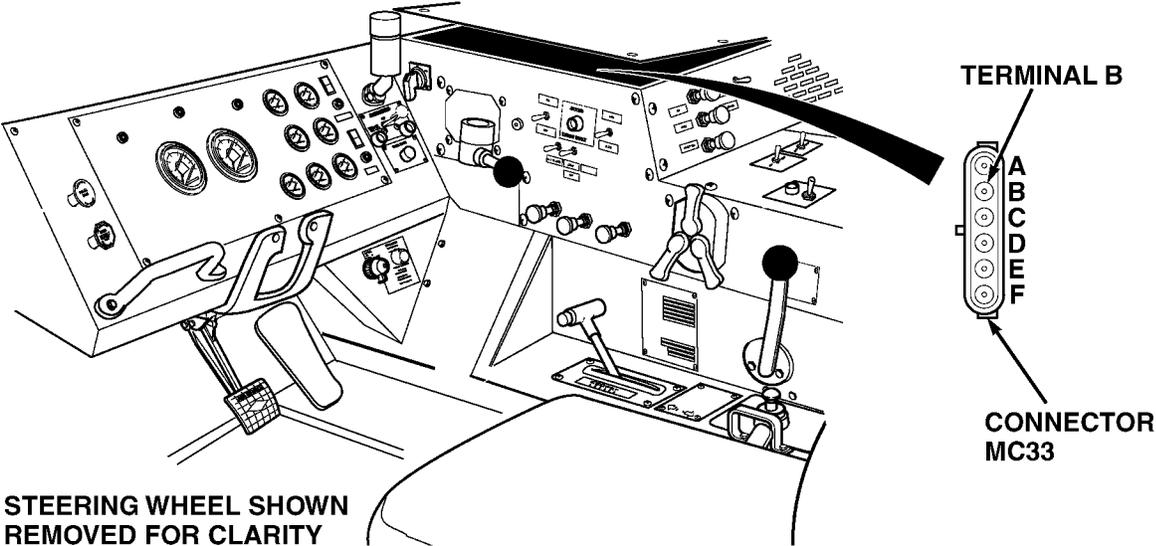
Malfunction	Test or Inspection	Corrective Action
LOAD HANDLING SYSTEM (LHS) (CONT)		
5. LOSS OF SUPPLY VOLTAGE TO DISTRIBUTION BOX (CONT).		
 <p data-bbox="180 1178 527 1230">STEERING WHEEL SHOWN REMOVED FOR CLARITY</p> <p data-bbox="1138 747 1300 772">TERMINAL B</p> <p data-bbox="1162 835 1203 989">A B C D E F</p> <p data-bbox="1162 1094 1336 1146">CONNECTOR MC33</p>		
<u>WARNING</u>		
<p>Remove all jewelry such as rings, dog tags, bracelets, etc. If jewelry or tools contact positive electrical circuits, a direct short may result. Damage to equipment and injury or death to personnel may occur.</p>		
<p>Step 5. Check continuity at harness connector MC33 terminal B and chassis ground.</p>		
<p style="padding-left: 40px;">If there is no continuity, repair wire 1435 or notify DS Maintenance.</p>		

Organizational Maintenance Instructions (Cont)

Table 4-3. Load Handling System (LHS) Troubleshooting (CONT)

Malfunction	Test or Inspection	Corrective Action
LOAD HANDLING SYSTEM (LHS) (CONT)		
5. LOSS OF SUPPLY VOLTAGE TO DISTRIBUTION BOX (CONT).		
<p>The diagram illustrates the electrical connection for terminal F. On the left, a circular terminal block is shown with terminals labeled A through S. Terminal F is specifically highlighted. A cable connects this terminal to a cylindrical connector labeled 'CONNECTOR MC84'. This connector is shown mounted on a truck chassis, with a cable extending from the front of the vehicle towards the connector.</p>		
<u>WARNING</u>		
<p>Remove all jewelry such as rings, dog tags, bracelets, etc. If jewelry or tools contact positive electrical circuits, a direct short may result. Damage to equipment and injury or death to personnel may occur.</p>		
<p>Step 6. Check continuity at harness connector MC84 terminal F and chassis ground.</p>		
<p style="padding-left: 40px;">If there is no continuity repair wire 1435 or notify DS Maintenance.</p>		

Organizational Maintenance Instructions (Cont)

4-18. TROUBLESHOOTING INSTRUCTIONS (CONT).

Table 4-3. Load Handling System (LHS) Troubleshooting (CONT)

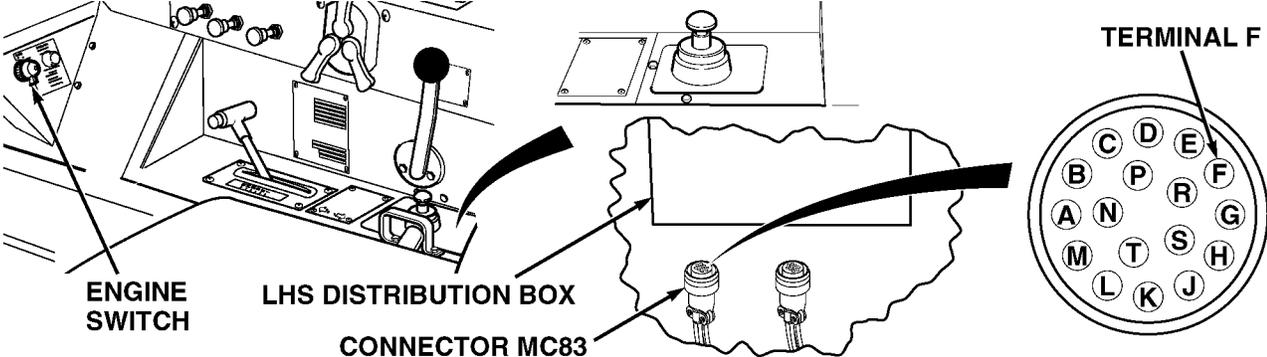
Malfunction	Test or Inspection	Corrective Action
LOAD HANDLING SYSTEM (LHS) (CONT)		
5. LOSS OF SUPPLY VOLTAGE TO DISTRIBUTION BOX (CONT).		
 <p>The diagram illustrates the electrical connection between the engine switch, the LHS distribution box, and the MC83 connector. A circular terminal block is shown with terminals labeled A through S. Terminal F is specifically highlighted with an arrow and the label 'TERMINAL F'.</p>		
<u>WARNING</u>		
<p>Remove all jewelry such as rings, dog tags, bracelets, etc. If jewelry or tools contact positive electrical circuits, a direct short may result. Damage to equipment and injury or death to personnel may occur.</p>		
<p>Step 7. Check continuity at harness connector MC83 terminal F and chassis ground. If there is no continuity, repair wire 1435 or notify DS Maintenance.</p>		

Organizational Maintenance Instructions (Cont)

Table 4-3. Load Handling System (LHS) Troubleshooting (CONT)

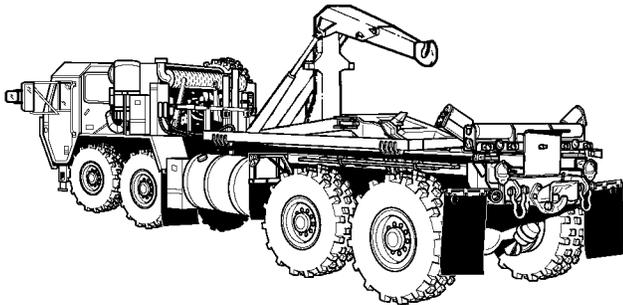
Malfunction	Test or Inspection	Corrective Action
LOAD HANDLING SYSTEM (LHS) (CONT)		
5. LOSS OF SUPPLY VOLTAGE TO DISTRIBUTION BOX (CONT).		
		
<p>Step 8. Check for proper LHS operation.</p> <p style="padding-left: 40px;">If LHS does not operate, fault not corrected. Notify DS Maintenance.</p>		

Organizational Maintenance Instructions (Cont)

4-18. TROUBLESHOOTING INSTRUCTIONS (CONT).

Table 4-3. Load Handling System (LHS) Troubleshooting (CONT)

Malfunction

Test or Inspection

Corrective Action

LOAD HANDLING SYSTEM (LHS) (CONT)

6. LOSS OF SUPPLY VOLTAGE TO MAIN JUNCTION BOX.

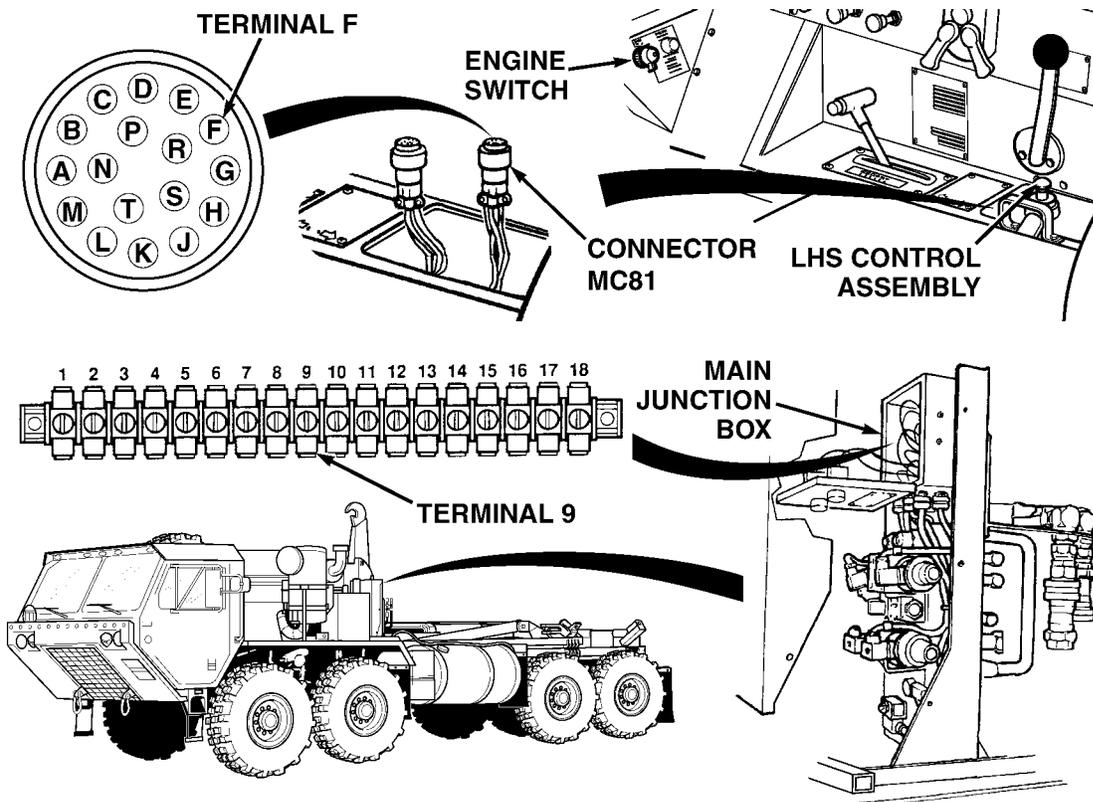

WARNING

Remove all jewelry such as rings, dog tags, bracelets, etc. If jewelry or tools contact positive electrical circuits, a direct short may result. Damage to equipment and injury or death to personnel may occur.

Step 1. Check continuity on wire 1472 at harness connector MC81 terminal F and main junction box terminal 9.

If there is no continuity, repair wire 1472 or notify DS Maintenance.

Organizational Maintenance Instructions (Cont)

Table 4-3. Load Handling System (LHS) Troubleshooting (CONT)

Malfunction	Test or Inspection	Corrective Action
LOAD HANDLING SYSTEM (LHS) (CONT)		
6. LOSS OF SUPPLY VOLTAGE TO MAIN JUNCTION BOX (CONT).		
<p>The diagram illustrates the electrical connection between the terminal strip and the main junction box. The terminal strip is labeled with terminals 1 through 18. Terminal 9 is specifically highlighted with an arrow pointing to the main junction box. A second arrow points from the main junction box to a side view of the truck's Load Handling System (LHS) mechanism, indicating the location of the junction box on the vehicle.</p>		
<u>WARNING</u>		
<p>Remove all jewelry such as rings, dog tags, bracelets, etc. If jewelry or tools contact positive electrical circuits, a direct short may result. Damage to equipment and injury or death to personnel may occur.</p>		
Step 2.	Check for loss of voltage to distribution box.	Refer to Fault 5.
Step 3.	Check for 22 to 28 Vdc at terminal 9 of main junction box terminal.	If Vdc measurement is below specification, replace LHS distribution box (Para 4-34).

Organizational Maintenance Instructions (Cont)

4-18. TROUBLESHOOTING INSTRUCTIONS (CONT).

Table 4-3. Load Handling System (LHS) Troubleshooting (CONT)

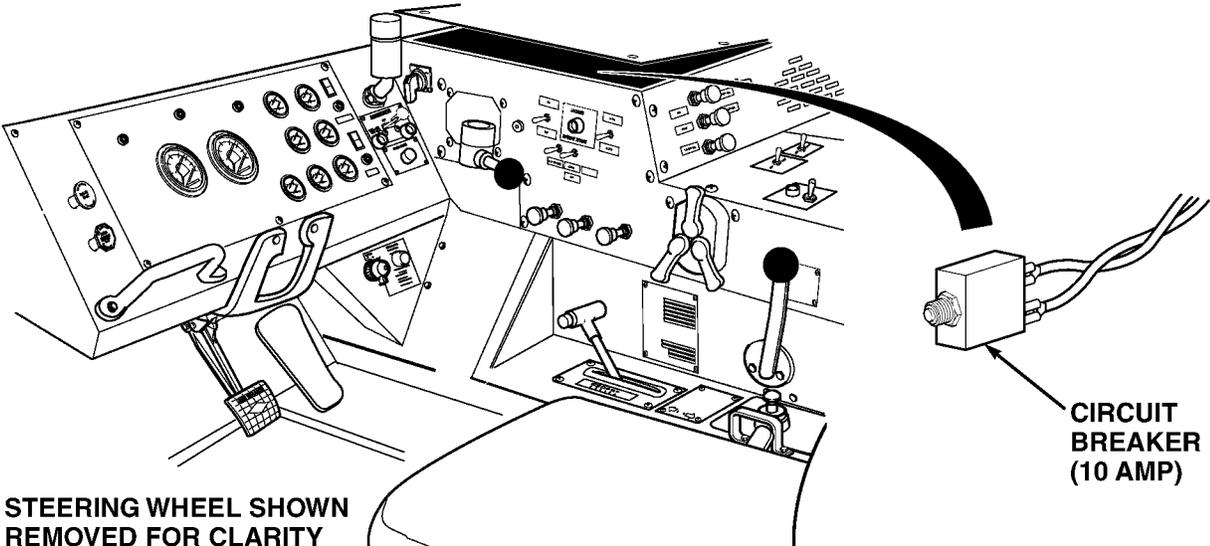
Malfunction	Test or Inspection	Corrective Action
LOAD HANDLING SYSTEM (LHS) (CONT)		
7. LHS CIRCUIT BREAKER DOES NOT OPERATE.		
 <p data-bbox="154 1171 503 1228">STEERING WHEEL SHOWN REMOVED FOR CLARITY</p> <p data-bbox="1218 1081 1356 1165">CIRCUIT BREAKER (10 AMP)</p>		
<u>WARNING</u>		
<p>Remove all jewelry such as rings, dog tags, bracelets, etc. If jewelry or tools contact positive electrical circuits, a direct short may result. Damage to equipment and injury or death to personnel may occur.</p>		
<p>Step 1. Check for 22 to 28 Vdc on both sides of circuit breaker.</p>		
<p style="padding-left: 40px;">If Vdc measurement is below specification, replace circuit breaker (Para 4-33).</p>		

Organizational Maintenance Instructions (Cont)

Table 4-3. Load Handling System (LHS) Troubleshooting (CONT)

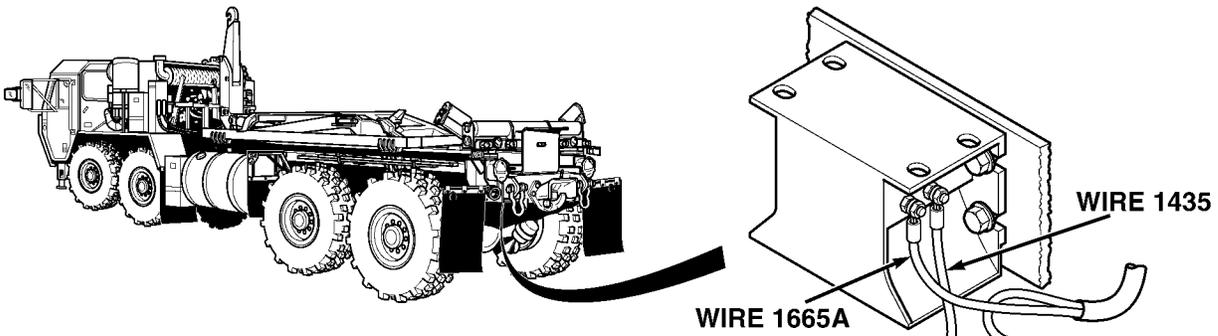
Malfunction	Test or Inspection	Corrective Action
LOAD HANDLING SYSTEM (LHS) (CONT)		
8. REVERSE ALARM DOES NOT OPERATE.		
NOTE		
For Fault 8 the engine must be running.		
		
<u>WARNING</u>		
Remove all jewelry such as rings, dog tags, bracelets, etc. If jewelry or tools contact positive electrical circuits, a direct short may result. Damage to equipment and injury or death to personnel may occur.		
Step 1.	Check for continuity on wires 1435 at reverse alarm and chassis ground.	If there is no continuity, repair wire 1435 or notify DS Maintenance.
Step 2.	With light switch in service drive position, check for 22 to 28 Vdc on wire 1665A at reverse alarm, with transmission range selector in R (Reverse).	If Vdc measurement is within specification, replace reverse alarm (Para 4-44).
		If Vdc measurement is below specification, go to Step 3. of this fault.

Organizational Maintenance Instructions (Cont)

4-18. TROUBLESHOOTING INSTRUCTIONS (CONT).

Table 4-3. Load Handling System (LHS) Troubleshooting (CONT)

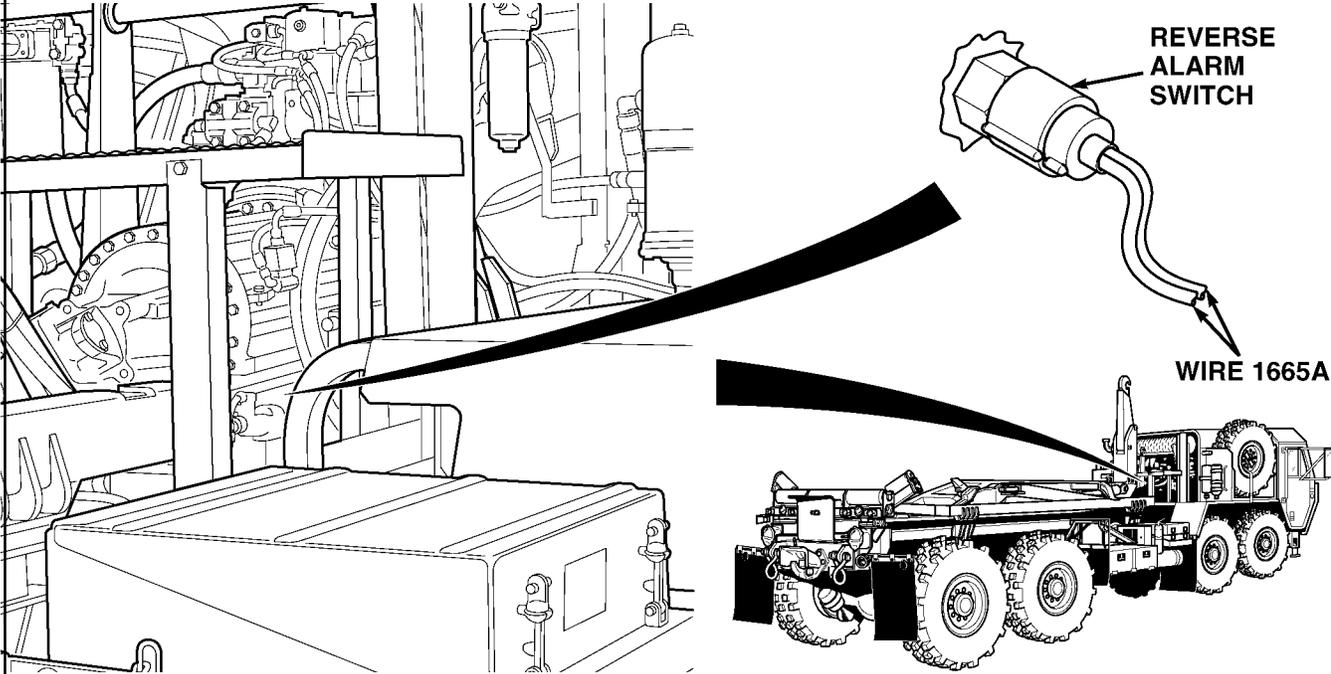
Malfunction	Test or Inspection	Corrective Action
LOAD HANDLING SYSTEM (LHS) (CONT)		
8. REVERSE ALARM DOES NOT OPERATE (CONT).		
 <p>The diagram illustrates the location of the reverse alarm switch and wire 1665A on a vehicle chassis. On the left, a detailed view shows the interior of the chassis with various mechanical components. On the right, a side view of the vehicle chassis shows the location of the reverse alarm switch and wire 1665A. A thick black arrow points from the reverse alarm switch to the wire 1665A, and another thick black arrow points from the wire 1665A to the chassis.</p>		
<u>WARNING</u>		
<p>Remove all jewelry such as rings, dog tags, bracelets, etc. If jewelry or tools contact positive electrical circuits, a direct short may result. Damage to equipment and injury or death to personnel may occur.</p>		
Step 3.	<p>With light switch in service drive position, check for 22 to 28 Vdc on wire 1665A at reverse alarm switch terminals, with transmission range selector in R (Reverse).</p>	
	<p>If Vdc measurement is within specification on one terminal and 0 Vdc is measured on other terminal, replace reverse alarm switch (Para 4-45).</p>	
	<p>If Vdc measurement is below specification on both terminals, go to Step 4. of this fault</p>	

Organizational Maintenance Instructions (Cont)

Table 4-3. Load Handling System (LHS) Troubleshooting (CONT)

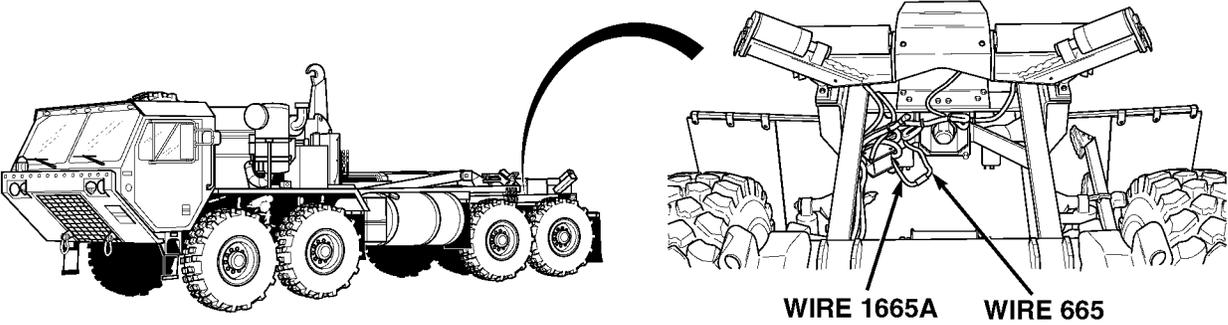
Malfunction	Test or Inspection	Corrective Action
LOAD HANDLING SYSTEM (LHS) (CONT)		
8. REVERSE ALARM DOES NOT OPERATE (CONT).		
		
<u>WARNING</u>		
<p>Remove all jewelry such as rings, dog tags, bracelets, etc. If jewelry or tools contact positive electrical circuits, a direct short may result. Damage to equipment and injury or death to personnel may occur.</p>		
Step 4.	<p>With light switch in service drive position, check for 22 to 28 Vdc on wire 1665A at splice to MILITARY CONNECTOR wire 665.</p>	<p>If Vdc measurement is below specification, repair wire 1665A, the splice, or notify DS Maintenance.</p>
Step 5.	<p>Check operation of reverse alarm.</p>	<p>If reverse alarm does not operate, fault is not corrected. Notify DS Maintenance.</p>

Organizational Maintenance Instructions (Cont)

4-18. TROUBLESHOOTING INSTRUCTIONS (CONT).

Table 4-3. Load Handling System (LHS) Troubleshooting (CONT)

Malfunction	Test or Inspection	Corrective Action
LOAD HANDLING SYSTEM (LHS) (CONT)		
9. LOSS OF MAIN FRAME SAFE LOWERING FUNCTION.		
<p>The diagram illustrates the hydraulic selector switch on the left, which has positions for OFF, AUTO, and MAN. A curved arrow points from the OFF position to the hydraulic system. In the center, a control panel features a joystick and a button labeled 'TRANSIT VALVE MANUAL PUSH BUTTON'. A curved arrow points from this button to the 'MAIN JUNCTION BOX' on the right, which is a vertical assembly of hydraulic components.</p>		
<u>WARNING</u>		
<p>Keep clear of equipment when equipment is being raised or lowered. Equipment may fall and cause serious injury or death to personnel.</p>		
<p>Step 1. Lower main frame using transit valve manual push button.</p>		
<p style="padding-left: 40px;">If main frame lowers to transit position, go to Step 2. of this fault.</p>		
<p style="padding-left: 40px;">If main frame does not lower to transit position, lower main frame using joystick. Notify DS Maintenance.</p>		

Organizational Maintenance Instructions (Cont)

Table 4-3. Load Handling System (LHS) Troubleshooting (CONT)

Malfunction	Test or Inspection	Corrective Action
LOAD HANDLING SYSTEM (LHS) (CONT)		
9. LOSS OF MAIN FRAME SAFE LOWERING FUNCTION (CONT).		
<u>WARNING</u>		
<p>Remove all jewelry such as rings, dog tags, bracelets, etc. If jewelry or tools contact positive electrical circuits, a direct short may result. Damage to equipment and injury or death to personnel may occur.</p>		
<u>CAUTION</u>		
<p>Do not allow the LHS control box assembly cover to hang from console by the wire connections to the control box assembly. Failure to comply will damage the wire connections.</p>		
Step 2.	<p>Check for 22 to 28 Vdc at transit valve harness connector terminal 2 with ENGINE switch ON and main frame safe lowering button pushed in.</p>	<p>If there are 22 to 28 Vdc go to Step 14. of this Fault.</p>
		<p>If Vdc measurement is below specification, go to Step 3. of this Fault.</p>

Organizational Maintenance Instructions (Cont)

4-18. TROUBLESHOOTING INSTRUCTIONS (CONT).

Table 4-3. Load Handling System (LHS) Troubleshooting (CONT)

Malfunction	Test or Inspection	Corrective Action
LOAD HANDLING SYSTEM (LHS) (CONT)		
9. LOSS OF MAIN FRAME SAFE LOWERING FUNCTION (CONT).		
Step 3.	Check for 22 to 28 Vdc at main junction box terminal 9 with ENGINE switch in the ON position.	If Vdc measurement is below specification, go to Step 1. of Fault 6 .
<u>WARNING</u>		
Remove all jewelry such as rings, dog tags, bracelets, etc. If jewelry or tools contact positive electrical circuits, a direct short may result. Damage to equipment and injury or death to personnel may occur.		
<u>CAUTION</u>		
Do not allow the LHS main junction box cover to hang from console by the wire connections to the main junction box assembly. Failure to comply will damage the wire connections.		
Step 4.	Check for continuity at main frame safe lowering button wire connection points with button pushed in.	If there is no continuity, replace main frame safe lowering button.
Step 5.	Check for 22 to 28 Vdc on wire 1479 at main frame safe lowering button with ENGINE switch in the ON position.	If Vdc measurement is below specification, turn ENGINE switch to OFF position and repair wire 1479 or notify DS Maintenance.

Organizational Maintenance Instructions (Cont)

Table 4-3. Load Handling System (LHS) Troubleshooting (CONT)

Malfunction	Test or Inspection	Corrective Action
LOAD HANDLING SYSTEM (LHS) (CONT)		
9. LOSS OF MAIN FRAME SAFE LOWERING FUNCTION (CONT).		
<u>WARNING</u>		
<p>Remove all jewelry such as rings, dog tags, bracelets, etc. If jewelry or tools contact positive electrical circuits, a direct short may result. Damage to equipment and injury or death to personnel may occur.</p>		
<u>CAUTION</u>		
<p>Do not allow the LHS main junction box cover to hang from console by the wire connections to the main junction box. Failure to comply will damage the wire connections.</p>		
Step 6.	<p>Check for 22 to 28 Vdc on wire 1478 at main junction box rectifier with ENGINE switch ON and main frame safe lowering button pushed in.</p>	<p>If Vdc measurement is below specification, turn ENGINE switch to OFF position and repair wire 1478 or notify DS Maintenance.</p>

Organizational Maintenance Instructions (Cont)

4-18. TROUBLESHOOTING INSTRUCTIONS (CONT).

Table 4-3. Load Handling System (LHS) Troubleshooting (CONT)

Malfunction	Test or Inspection	Corrective Action
LOAD HANDLING SYSTEM (LHS) (CONT)		
9. LOSS OF MAIN FRAME SAFE LOWERING FUNCTION (CONT).		
<u>WARNING</u>		
<p>Remove all jewelry such as rings, dog tags, bracelets, etc. If jewelry or tools contact positive electrical circuits, a direct short may result. Damage to equipment and injury or death to personnel may occur.</p>		
<u>CAUTION</u>		
<p>Do not allow the LHS main junction box cover to hang from console by the wire connections to the main junction box. Failure to comply will damage the wire connections.</p>		
<u>NOTE</u>		
<p>Tag and mark all wires prior to disconnecting.</p>		
Step 7.	Disconnect all wires from rectifier.	
Step 8.	Set multimeter select switch to diode position.	
Step 9.	Connect positive (+) multimeter lead at negative terminal.	
Step 10.	Connect negative (-) multimeter lead at each AC terminal.	
	If there is not any Vdc present at both AC terminals, replace rectifier (Para 4-40).	
	If there is any Vdc present at both AC terminals, perform Step 11. and Step 12. below.	
Step 11.	Connect negative (-) multimeter lead at positive terminal on rectifier.	
Step 12.	Connect positive (+) multimeter lead at each AC terminal.	
	If there is not any Vdc present at both AC terminals, replace rectifier (Para 4-40) and perform Step 13. below.	
	If there is any Vdc present, rectifier is OK.	
Step 13.	Connect wires to rectifier.	

Organizational Maintenance Instructions (Cont)

Table 4-3. Load Handling System (LHS) Troubleshooting (CONT)

Malfunction	Test or Inspection	Corrective Action
LOAD HANDLING SYSTEM (LHS) (CONT)		
9. LOSS OF MAIN FRAME SAFE LOWERING FUNCTION (CONT).		
<p>The diagram illustrates the electrical circuit for the main frame safe lowering function. On the left, a side view of a truck is shown with a callout to a 'RECTIFIER' box. The rectifier has three wires: 'WIRE 1478' connected to an 'AC' terminal, 'WIRE 1480' connected to a '+' terminal, and 'WIRE 1463' connected to another 'AC' terminal. On the right, a 'MAIN JUNCTION BOX' is shown with a callout to a 'TRANSIT VALVE MANUAL PUSH BUTTON'. This button is connected to a 'HARNESS CONNECTOR' which has two terminals: 'TERMINAL 1' and 'TERMINAL 2'. Arrows indicate the path of the wires from the rectifier through the junction box to the harness connector.</p>		
<u>WARNING</u>		
<p>Remove all jewelry such as rings, dog tags, bracelets, etc. If jewelry or tools contact positive electrical circuits, a direct short may result. Damage to equipment and injury or death to personnel may occur.</p>		
<p>Step 14. Check for continuity measured between rectifier wire 1480 and transit valve harness connector terminal 2.</p>		
<p style="padding-left: 40px;">If there is no continuity, repair wire 1480 or notify DS Maintenance.</p>		

Organizational Maintenance Instructions (Cont)

4-18. TROUBLESHOOTING INSTRUCTIONS (CONT).

Table 4-3. Load Handling System (LHS) Troubleshooting (CONT)

Malfunction	Test or Inspection	Corrective Action
LOAD HANDLING SYSTEM (LHS) (CONT)		
9. LOSS OF MAIN FRAME SAFE LOWERING FUNCTION (CONT).		
<p>The diagram shows a vertical assembly of electrical components. At the top is the 'MAIN JUNCTION BOX'. Below it is the 'TRANSIT VALVE HARNESS CONNECTOR'. At the bottom of the connector are 'TERMINAL 1' and 'TERMINAL 2'. A 'WARNING' box is located below the diagram.</p>		
<u>WARNING</u>		
<p>Remove all jewelry such as rings, dog tags, bracelets, etc. If jewelry or tools contact positive electrical circuits, a direct short may result. Damage to equipment and injury or death to personnel may occur.</p>		
<p>Step 15. Check continuity at transit valve harness connector terminal 1 and chassis ground.</p>		
<p style="padding-left: 40px;">If there is no continuity, repair wire 1435 or notify DS Maintenance.</p>		

Organizational Maintenance Instructions (Cont)

Table 4-3. Load Handling System (LHS) Troubleshooting (CONT)

Malfunction	Test or Inspection	Corrective Action
LOAD HANDLING SYSTEM (LHS) (CONT)		
9. LOSS OF MAIN FRAME SAFE LOWERING FUNCTION (CONT).		
<p>The diagram illustrates the hydraulic selector switch, main junction box, and transit valve manual push button. The hydraulic selector switch is shown with 'OFF', 'AUTO', and 'MAN. H.A.' positions. The main junction box is a large rectangular unit with various electrical connections. The transit valve manual push button is a cylindrical component with a textured top. Arrows indicate the location of each component within the overall LHS assembly.</p>		
<u>WARNING</u>		
<p>Keep clear of equipment when equipment is being raised or lowered. Equipment may fall and cause serious injury or death to personnel.</p>		
<p>Step 16. Check for proper main frame safe lowering operation.</p>		
<p style="padding-left: 40px;">If main frame does not lower, fault not corrected. Notify DS Maintenance.</p>		

Organizational Maintenance Instructions (Cont)

4-18. TROUBLESHOOTING INSTRUCTIONS (CONT).

Table 4-3. Load Handling System (LHS) Troubleshooting (CONT)

Malfunction	Test or Inspection	Corrective Action
LOAD HANDLING SYSTEM (LHS) (CONT)		
10. LOSS OF HOOK ARM SAFE LOWERING FUNCTION.		
<u>WARNING</u>		
<p>Remove all jewelry such as rings, dog tags, bracelets, etc. If jewelry or tools contact positive electrical circuits, a direct short may result. Damage to equipment and injury or death to personnel may occur.</p>		
<p>Step 1. Check for 22 to 28 Vdc at main junction box terminal 10 with ENGINE switch ON and hook arm safe lowering button pushed in.</p>		
<p style="padding-left: 40px;">If Vdc measurement is below specification, go to Step 5. of this Fault.</p>		

Organizational Maintenance Instructions (Cont)

Table 4-3. Load Handling System (LHS) Troubleshooting (CONT)

Malfunction	Test or Inspection	Corrective Action
LOAD HANDLING SYSTEM (LHS) (CONT)		
10. LOSS OF HOOK ARM SAFE LOWERING FUNCTION (CONT).		
<p>1 2 3 4 5 6 7 8 9 10 11 12 13 14 15 16 17 18</p> <p>MAIN JUNCTION BOX</p> <p>TERMINAL 10</p> <p>LHS CONTROL BOX COVER SHOWN REMOVED</p> <p>SAFE LOWERING SOLENOID VALVE HARNESS CONNECTOR</p> <p>TERMINAL 2</p> <p>SAFE LOWERING SOLENOID VALVE</p> <p>WOODEN BLOCKS</p>		

Organizational Maintenance Instructions (Cont)

4-18. TROUBLESHOOTING INSTRUCTIONS (CONT).

Table 4-3. Load Handling System (LHS) Troubleshooting (CONT)

Malfunction	Test or Inspection	Corrective Action
LOAD HANDLING SYSTEM (LHS) (CONT)		
10. LOSS OF HOOK ARM SAFE LOWERING FUNCTION (CONT).		
<u>WARNING</u>		
		<ul style="list-style-type: none"> • Keep clear of equipment when equipment is being raised or lowered. Equipment may fall and cause serious injury or death to personnel. • Remove all jewelry such as rings, dog tags, bracelets, etc. If jewelry or tools contact positive electrical circuits, a direct short may result. Damage to equipment and injury or death to personnel may occur. • Never crawl under equipment when performing maintenance unless equipment is securely blocked. Equipment may fall and cause serious injury or death to personnel. • Do not work on any item supported only by lift jacks or hoist. Always use blocks or proper stands to support the item prior to any work. Equipment may fall and cause injury or death to personnel.
Step 2.	Check for continuity on wire 1470 at both left side safe lowering valve harness connectors terminal 2 and ground with main junction box terminal 10 jumpered to ground.	<p style="text-align: center;">If there is no continuity, repair wire 1470 or notify DS Maintenance.</p>

Organizational Maintenance Instructions (Cont)

Table 4-3. Load Handling System (LHS) Troubleshooting (CONT)

Malfunction	Test or Inspection	Corrective Action
LOAD HANDLING SYSTEM (LHS) (CONT)		
10. LOSS OF HOOK ARM SAFE LOWERING FUNCTION (CONT).		
WARNING		
<p>Remove all jewelry such as rings, dog tags, bracelets, etc. If jewelry or tools contact positive electrical circuits, a direct short may result. Damage to equipment and injury or death to personnel may occur.</p>		
Step 3.	<p>Check for continuity on wire 1475 at both right side safe lowering valve harness connectors terminal 2 and chassis ground with main junction box terminal 10 jumpered to ground.</p>	
<p>If there is no continuity, repair wire 1475 or notify DS Maintenance.</p>		

Organizational Maintenance Instructions (Cont)

4-18. TROUBLESHOOTING INSTRUCTIONS (CONT).

Table 4-3. Load Handling System (LHS) Troubleshooting (CONT)

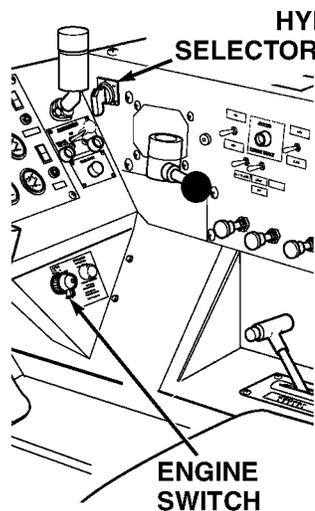
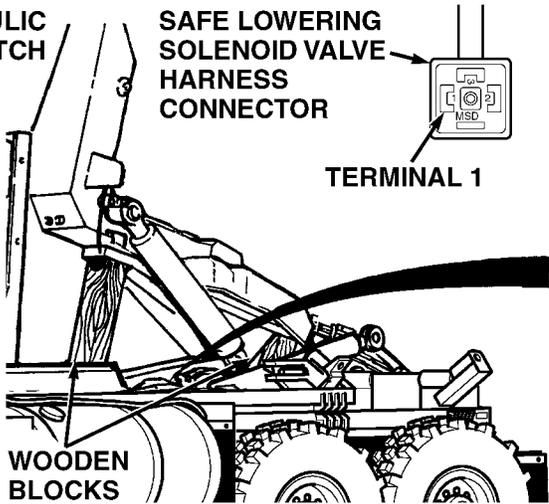
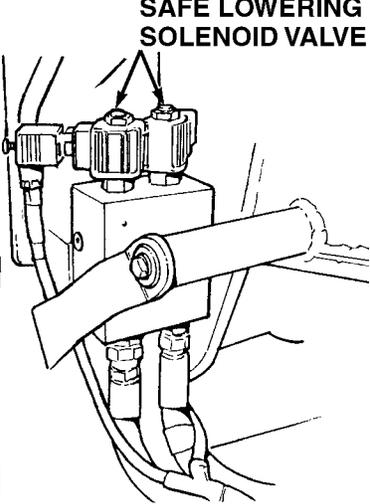
Malfunction	Test or Inspection	Corrective Action
LOAD HANDLING SYSTEM (LHS) (CONT)		
10. LOSS OF HOOK ARM SAFE LOWERING FUNCTION (CONT).		
 <p>HYDRAULIC SELECTOR SWITCH</p> <p>ENGINE SWITCH</p>	 <p>SAFE LOWERING SOLENOID VALVE HARNESS CONNECTOR</p> <p>TERMINAL 1</p> <p>WOODEN BLOCKS</p>	 <p>SAFE LOWERING SOLENOID VALVE</p>
<u>WARNING</u>		
<ul style="list-style-type: none"> • Keep clear of equipment when equipment is being raised or lowered. Equipment may fall and cause serious injury or death to personnel. • Never crawl under equipment when performing maintenance unless equipment is securely blocked. Equipment may fall and cause serious injury or death to personnel. • Do not work on any item supported only by lift jacks or hoist. Always use blocks or proper stands to support the item prior to any work. Equipment may fall and cause injury or death to personnel. 		
Step 4.	Check for continuity between ground and all four safe lowering valve harness connectors terminal 1.	
If there is no continuity, repair wire 1435 or notify DS Maintenance.		

Organizational Maintenance Instructions (Cont)

Table 4-3. Load Handling System (LHS) Troubleshooting (CONT)

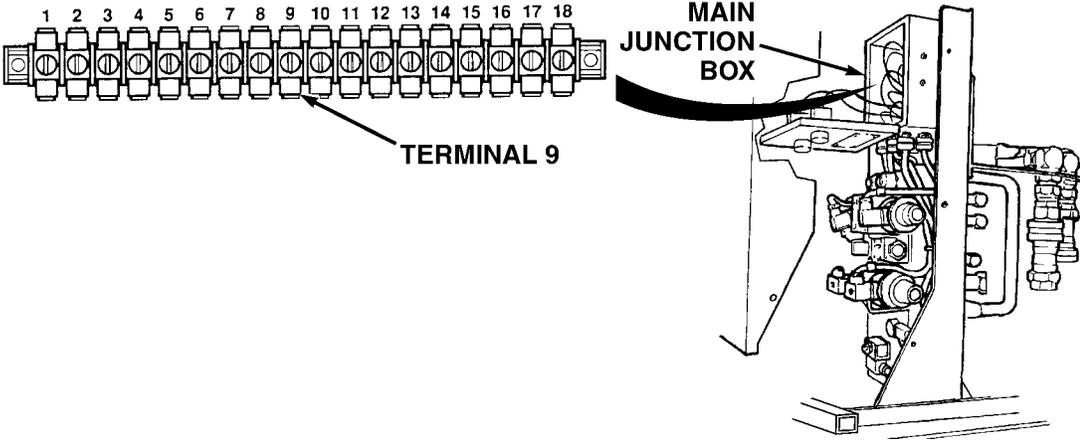
Malfunction	Test or Inspection	Corrective Action
LOAD HANDLING SYSTEM (LHS) (CONT)		
10. LOSS OF HOOK ARM SAFE LOWERING FUNCTION (CONT).		
<u>WARNING</u>		
<p>Remove all jewelry such as rings, dog tags, bracelets, etc. If jewelry or tools contact positive electrical circuits, a direct short may result. Damage to equipment and injury or death to personnel may occur.</p>		
Step 5.	<p>Check for 22 to 28 Vdc at main junction box terminal 9 with ENGINE switch in ON position.</p>	
<p style="padding-left: 40px;">If Vdc measurement is below specification, go to Step 1. of Fault 6.</p>		

Organizational Maintenance Instructions (Cont)

4-18. TROUBLESHOOTING INSTRUCTIONS (CONT).

Table 4-3. Load Handling System (LHS) Troubleshooting (CONT)

Malfunction	Test or Inspection	Corrective Action
LOAD HANDLING SYSTEM (LHS) (CONT)		
10. LOSS OF HOOK ARM SAFE LOWERING FUNCTION (CONT).		
<u>WARNING</u>		
<p>Remove all jewelry such as rings, dog tags, bracelets, etc. If jewelry or tools contact positive electrical circuits, a direct short may result. Damage to equipment and injury or death to personnel may occur.</p>		
Step 6.	<p>Check continuity between hook-arm safe lowering button wire connection points with button pushed in.</p>	<p>If there is no continuity, replace hook-arm safe lowering button (Para 4-39).</p>
Step 7.	<p>Check for 22 to 28 Vdc on wire 1479 at main frame safe lowering button with ENGINE switch in ON position.</p>	<p>If Vdc measurement is below specification, repair wire 1479 or notify DS Maintenance.</p>

Organizational Maintenance Instructions (Cont)

Table 4-3. Load Handling System (LHS) Troubleshooting (CONT)

Malfunction	Test or Inspection	Corrective Action
LOAD HANDLING SYSTEM (LHS) (CONT)		
10. LOSS OF HOOK ARM SAFE LOWERING FUNCTION (CONT).		
<u>WARNING</u>		
<p>Remove all jewelry such as rings, dog tags, bracelets, etc. If jewelry or tools contact positive electrical circuits, a direct short may result. Damage to equipment and injury or death to personnel may occur.</p>		
<p>Step 8. Check for continuity between wire 1477 at hook arm safe lowering button and main junction box terminal 10.</p>		
<p>If there is no continuity, repair wire 1477 or notify DS Maintenance.</p>		

Organizational Maintenance Instructions (Cont)

4-18. TROUBLESHOOTING INSTRUCTIONS (CONT).

Table 4-3. Load Handling System (LHS) Troubleshooting (CONT)

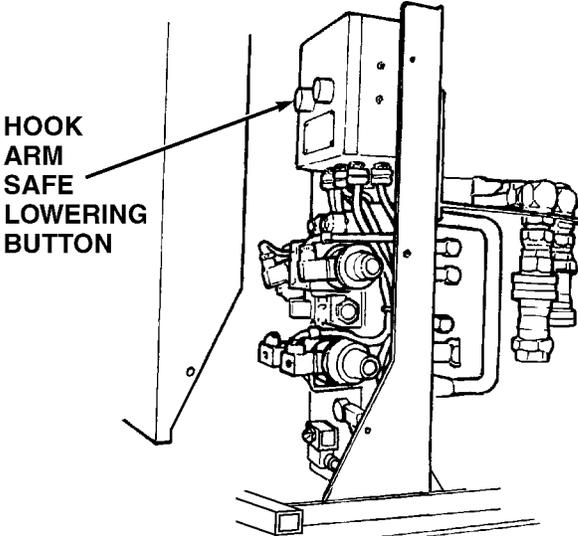
Malfunction	Test or Inspection	Corrective Action
LOAD HANDLING SYSTEM (LHS) (CONT)		
10. LOSS OF HOOK ARM SAFE LOWERING FUNCTION (CONT).		
 <p>The diagram shows a side view of the hook arm safe lowering mechanism. A rectangular control panel is mounted on a vertical support structure. A button is located on the left side of this panel. An arrow points from the text 'HOOK ARM SAFE LOWERING BUTTON' to this button. Below the panel, the hook arm and its associated hydraulic cylinders are visible, extending from the support structure.</p>		
<u>WARNING</u>		
<p>Keep clear of equipment when equipment is being raised or lowered. Equipment may fall and cause serious injury or death to personnel.</p>		
<p>Step 9. Check for proper hook arm safe lowering operation.</p>		
<p style="padding-left: 40px;">If hook arm does not lower to transit position, fault not corrected. Notify DS Maintenance.</p>		

Organizational Maintenance Instructions (Cont)

Table 4-3. Load Handling System (LHS) Troubleshooting (CONT)

Malfunction	Test or Inspection	Corrective Action
LOAD HANDLING SYSTEM (LHS) (CONT)		
11. LHS DOES NOT OPERATE.		
<u>WARNING</u>		
<p>The LHS hydraulic system operates at oil pressures up to 1,725 psi (11 894 kPa). Never disconnect any hydraulic line or fitting without first dropping pressure to zero. Failure to comply may result in serious injury or death to personnel.</p>		
Step 1.	<p>Check LHS hydraulic hoses 902 and 2917 for damage, crimps, or leaks and fittings for damage or leaks.</p>	<p>If hoses are damaged, crimped, or leaking, replace hoses. If fittings are leaking, tighten them.</p>

Organizational Maintenance Instructions (Cont)

4-18. TROUBLESHOOTING INSTRUCTIONS (CONT).

Table 4-3. Load Handling System (LHS) Troubleshooting (CONT)

Malfunction	Test or Inspection	Corrective Action
LOAD HANDLING SYSTEM (LHS) (CONT)		
11. LHS DOES NOT OPERATE (CONT).		
<u>WARNING</u>		
<p>Keep clear of equipment when equipment is being raised or lowered. Equipment may fall and cause serious injury or death to personnel.</p>		
<u>NOTE</u>		
<p>Only remove center screw on engine side of LHS main junction box cover.</p>		
<p>Step 2. Operate LHS with free flow valve manual push button pushed in.</p>		
<p>If LHS does not operate, notify DS Maintenance.</p>		

Organizational Maintenance Instructions (Cont)

Table 4-3. Load Handling System (LHS) Troubleshooting (CONT)

Malfunction	Test or Inspection	Corrective Action
LOAD HANDLING SYSTEM (LHS) (CONT)		
11. LHS DOES NOT OPERATE (CONT).		
<p>The diagram illustrates the electrical components for the LHS troubleshooting step. On the left, a control panel features an ENGINE SWITCH and a JOYSTICK. A curved arrow points from the joystick area to a detailed view of the HYDRAULIC SELECTOR SWITCH, which has positions for OFF, AUTO, and MAN H.A. Below this, a terminal block is shown with TERMINAL 2 highlighted. Another curved arrow points from terminal 2 to a FREE FLOW VALVE CONNECTOR on a hydraulic valve assembly.</p>		
<u>WARNING</u>		
<p>Remove all jewelry such as rings, dog tags, bracelets, etc. If jewelry or tools contact positive electrical circuits, a direct short may result. Damage to equipment and injury or death to personnel may occur.</p>		
<p>Step 3. Check for 22 to 28 Vdc at free flow valve harness connector terminal 2 with hydraulic selector switch in MAN H.A. position, ENGINE switch ON and joystick in LOAD position.</p>		
<p style="padding-left: 40px;">If there are 22 to 28 Vdc, go to Step 7. of this Fault.</p>		
<p style="padding-left: 40px;">If Vdc measurement is below specification, go to Step 4. of this Fault.</p>		

Organizational Maintenance Instructions (Cont)

4-18. TROUBLESHOOTING INSTRUCTIONS (CONT).

Table 4-3. Load Handling System (LHS) Troubleshooting (CONT)

Malfunction	Test or Inspection	Corrective Action
LOAD HANDLING SYSTEM (LHS) (CONT)		
11. LHS DOES NOT OPERATE (CONT).		
WARNING		
<p>Remove all jewelry such as rings, dog tags, bracelets, etc. If jewelry or tools contact positive electrical circuits, a direct short may result. Damage to equipment and injury or death to personnel may occur.</p>		
Step 4.	<p>Check for continuity between hydraulic selector switch connector MC94 terminal F and terminal B and also between switch connector MC94 terminal D and MC93 terminal E with switch in MAN H.A. position.</p>	
<p>If there is no continuity, replace hydraulic selector switch (Para 4-31).</p>		

Organizational Maintenance Instructions (Cont)

Table 4-3. Load Handling System (LHS) Troubleshooting (CONT)

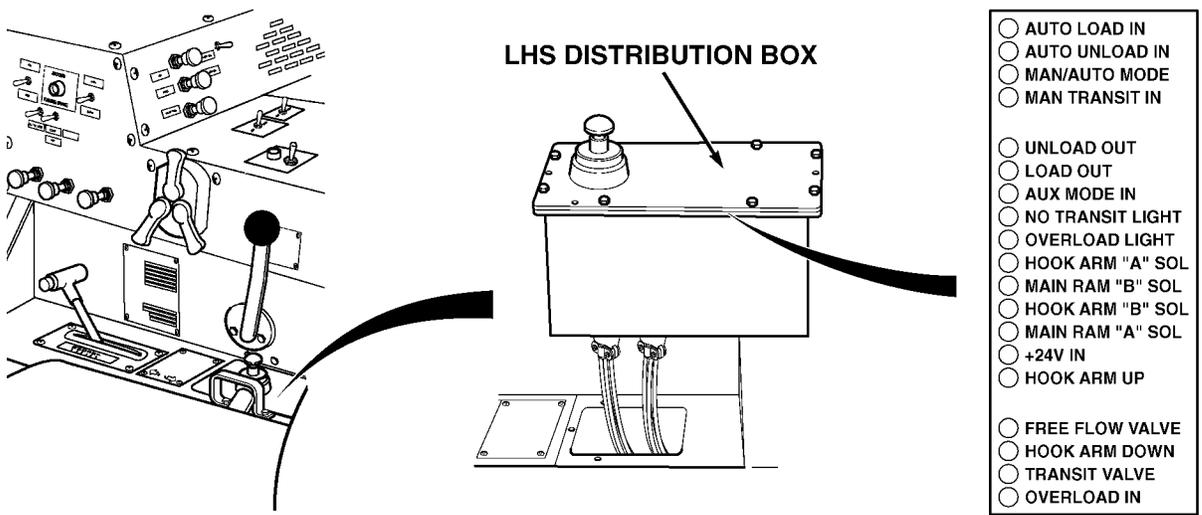
Malfunction	Test or Inspection	Corrective Action
LOAD HANDLING SYSTEM (LHS) (CONT)		
11. LHS DOES NOT OPERATE (CONT).		<ul style="list-style-type: none"> <input type="radio"/> AUTO LOAD IN <input type="radio"/> AUTO UNLOAD IN <input type="radio"/> MAN/AUTO MODE <input type="radio"/> MAN TRANSIT IN <input type="radio"/> UNLOAD OUT <input type="radio"/> LOAD OUT <input type="radio"/> AUX MODE IN <input type="radio"/> NO TRANSIT LIGHT <input type="radio"/> OVERLOAD LIGHT <input type="radio"/> HOOK ARM "A" SOL <input type="radio"/> MAIN RAM "B" SOL <input type="radio"/> HOOK ARM "B" SOL <input type="radio"/> MAIN RAM "A" SOL <input type="radio"/> +24V IN <input type="radio"/> HOOK ARM UP <input type="radio"/> FREE FLOW VALVE <input type="radio"/> HOOK ARM DOWN <input type="radio"/> TRANSIT VALVE <input type="radio"/> OVERLOAD IN
<u>WARNING</u>		
<p>Remove all jewelry such as rings, dog tags, bracelets, etc. If jewelry or tools contact positive electrical circuits, a direct short may result. Damage to equipment and injury or death to personnel may occur.</p>		
<u>CAUTION</u>		
<p>Do not allow the LHS distribution box assembly cover to hang from console by the wire connections to the control box assembly. Failure to comply will damage the wire connections</p>		
Step 5.	<p>With engine switch ON, joystick in LOAD position, and hydraulic selector switch in MAN H.A. position, check appropriate LHS distribution box indicator lights for proper operation.</p>	
	<p>If FREE FLOW VALVE light does not illuminate, replace LHS distribution box assembly (Para 4-34).</p>	

Organizational Maintenance Instructions (Cont)

4-18. TROUBLESHOOTING INSTRUCTIONS (CONT).

Table 4-3. Load Handling System (LHS) Troubleshooting (CONT)

Malfunction	Test or Inspection	Corrective Action
LOAD HANDLING SYSTEM (LHS) (CONT)		
11. LHS DOES NOT OPERATE (CONT).		
<u>WARNING</u>		
<p>Remove all jewelry such as rings, dog tags, bracelets, etc. If jewelry or tools contact positive electrical circuits, a direct short may result. Damage to equipment and injury or death to personnel may occur.</p>		
Step 6.	<p>Check for continuity on wire 1462 at harness connector MC81 terminal J and chassis ground, with free flow solenoid valve harness connector terminal 2 jumpered to chassis ground.</p>	<p>If there is no continuity, repair wire 1462 or notify DS Maintenance.</p>

Organizational Maintenance Instructions (Cont)

Table 4-3. Load Handling System (LHS) Troubleshooting (CONT)

Malfunction	Test or Inspection	Corrective Action
LOAD HANDLING SYSTEM (LHS) (CONT)		
11. LHS DOES NOT OPERATE (CONT).		
<p>The diagram shows a side view of the LHS assembly. A callout box on the left shows a terminal block with two terminals, labeled '1' and '2', and 'MSD' below them. An arrow points from this callout to a specific terminal on the main assembly, labeled 'TERMINAL 1'. Another arrow points to a connector on the assembly labeled 'FREE FLOW VALVE CONNECTOR'.</p>		
<u>WARNING</u>		
<p>Remove all jewelry such as rings, dog tags, bracelets, etc. If jewelry or tools contact positive electrical circuits, a direct short may result. Damage to equipment and injury or death to personnel may occur.</p>		
<p>Step 7. Check for continuity on wire 1435 between free flow solenoid valve harness connector terminal 1 and chassis ground.</p>		
<p>If there is no continuity, go to Step 8. of this Fault.</p>		
<p>If there is continuity, notify DS Maintenance.</p>		

Organizational Maintenance Instructions (Cont)

4-18. TROUBLESHOOTING INSTRUCTIONS (CONT).

Table 4-3. Load Handling System (LHS) Troubleshooting (CONT)

Malfunction	Test or Inspection	Corrective Action
LOAD HANDLING SYSTEM (LHS) (CONT)		
11. LHS DOES NOT OPERATE (CONT).		
<u>WARNING</u>		
<p>Remove all jewelry such as rings, dog tags, bracelets, etc. If jewelry or tools contact positive electrical circuits, a direct short may result. Damage to equipment and injury or death to personnel may occur.</p>		
Step 8.	<p>Check for continuity on wire 1435 between harness connector MC81 terminal L and chassis ground, with terminal 1 jumpered to chassis ground.</p>	<p>If there is no continuity, repair wire 1435 or notify DS Maintenance. If there is continuity, replace LHS distribution box (Para 4-34).</p>
Step 9.	<p>Check for proper LHS operation.</p>	<p>If LHS does not operate, fault not corrected. Notify DS Maintenance.</p>

Organizational Maintenance Instructions (Cont)

Table 4-3. Load Handling System (LHS) Troubleshooting (CONT)

Malfunction	Test or Inspection	Corrective Action
LOAD HANDLING SYSTEM (LHS) (CONT)		
12. HOOK ARM DOES NOT UNLOAD IN MANUAL MODE.		
<u>WARNING</u>		
<p>The LHS hydraulic system operates at oil pressures up to 1,725 psi (11 894 kPa). Never disconnect any hydraulic line or fitting without first dropping pressure to zero. Failure to comply may result in serious injury or death to personnel.</p>		
<p>Step 1. Check LHS hydraulic hoses 2881, 2882, 2891, and 2892 for damage, crimps, or leaks. Check fittings for leaks.</p>		
<p style="padding-left: 40px;">If hoses are damaged, crimped, or leaking, replace hoses. If fittings are leaking tighten them.</p>		

Organizational Maintenance Instructions (Cont)

4-18. TROUBLESHOOTING INSTRUCTIONS (CONT).

Table 4-3. Load Handling System (LHS) Troubleshooting (CONT)

Malfunction	Test or Inspection	Corrective Action
LOAD HANDLING SYSTEM (LHS) (CONT)		
12. HOOK ARM DOES NOT UNLOAD IN MANUAL MODE (CONT).		
<u>WARNING</u>		
<p>The LHS hydraulic system operates at oil pressures up to 1,725 psi (11 894 kPa). Never disconnect any hydraulic line or fitting without first dropping pressure to zero. Failure to comply may result in serious injury or death to personnel.</p>		
Step 2.	<p>Check LHS hydraulic tubes 2881, 2882, 2891, and 2892 for damage, crimps, or leaks. Check fittings for leaks.</p>	<p>If tubes are leaking, tighten fittings. If tubes are damaged, notify DS Maintenance.</p>

Organizational Maintenance Instructions (Cont)

Table 4-3. Load Handling System (LHS) Troubleshooting (CONT)

Malfunction	Test or Inspection	Corrective Action
LOAD HANDLING SYSTEM (LHS) (CONT)		
12. HOOK ARM DOES NOT UNLOAD IN MANUAL MODE (CONT).		
WARNING		
<p>Remove all jewelry such as rings, dog tags, bracelets, etc. If jewelry or tools contact positive electrical circuits, a direct short may result. Damage to equipment and injury or death to personnel may occur.</p>		
NOTE		
<p>Only remove center screw on engine side of LHS control box cover.</p>		
Step 3.	<p>Check for 22 to 28 Vdc at hook arm up directional control (DC) valve harness connector terminal 2 with ENGINE switch ON, hydraulic selector switch in MAN H.A. position, and joystick in UNLOAD position.</p>	
	<p>If Vdc measurement is below specification, go to Step 4. of this Fault.</p>	
	<p>If there are 22 to 28 Vdc go to Step 9. of this Fault.</p>	

Organizational Maintenance Instructions (Cont)

4-18. TROUBLESHOOTING INSTRUCTIONS (CONT).

Table 4-3. Load Handling System (LHS) Troubleshooting (CONT)

Malfunction	Test or Inspection	Corrective Action
LOAD HANDLING SYSTEM (LHS) (CONT)		
12. HOOK ARM DOES NOT UNLOAD IN MANUAL MODE (CONT).		
<p>The diagram illustrates the electrical connections for the LHS. It shows a side panel with various controls, an LHS distribution box, and two main connectors: MC94 and MC83. Connector MC94 has terminals A through F, with terminal E specifically labeled. Connector MC83 has terminals A through S, with terminal N specifically labeled. A circular terminal block diagram shows the layout of terminals A through S, with terminal N highlighted. Arrows indicate the connection paths between these components.</p>		
WARNING		
<p>Remove all jewelry such as rings, dog tags, bracelets, etc. If jewelry or tools contact positive electrical circuits, a direct short may result. Damage to equipment and injury or death to personnel may occur.</p>		
<p>Step 4. Check for continuity on wire 1489 between harness connector MC83 terminal N and harness connector MC94 terminal E.</p>		
<p>If there is no continuity, repair wire 1489 or notify DS Maintenance.</p>		

Organizational Maintenance Instructions (Cont)

Table 4-3. Load Handling System (LHS) Troubleshooting (CONT)

Malfunction	Test or Inspection	Corrective Action
LOAD HANDLING SYSTEM (LHS) (CONT)		
12. HOOK ARM DOES NOT UNLOAD IN MANUAL MODE (CONT).		
<u>WARNING</u>		
<p>Remove all jewelry such as rings, dog tags, bracelets, etc. If jewelry or tools contact positive electrical circuits, a direct short may result. Damage to equipment and injury or death to personnel may occur.</p>		
Step 5.	<p>Check for continuity on wire 1482 between harness connector MC83 terminal A and harness connector MC93 terminal D.</p>	<p>If there is no continuity, repair wire 1482.</p>

Organizational Maintenance Instructions (Cont)

4-18. TROUBLESHOOTING INSTRUCTIONS (CONT).

Table 4-3. Load Handling System (LHS) Troubleshooting (CONT)

Malfunction	Test or Inspection	Corrective Action
LOAD HANDLING SYSTEM (LHS) (CONT)		
12. HOOK ARM DOES NOT UNLOAD IN MANUAL MODE (CONT).		
<u>WARNING</u>		
<p>Remove all jewelry such as rings, dog tags, bracelets, etc. If jewelry or tools contact positive electrical circuits, a direct short may result. Damage to equipment and injury or death to personnel may occur.</p>		
Step 6.	<p>Check for continuity between hydraulic selector switch harness connector MC93 terminal D and harness connector MC94 terminal E with hydraulic selector switch in MAN H.A. position.</p>	<p>If there is no continuity, replace hydraulic selector switch (Para 4-31).</p>

Organizational Maintenance Instructions (Cont)

Table 4-3. Load Handling System (LHS) Troubleshooting (CONT)

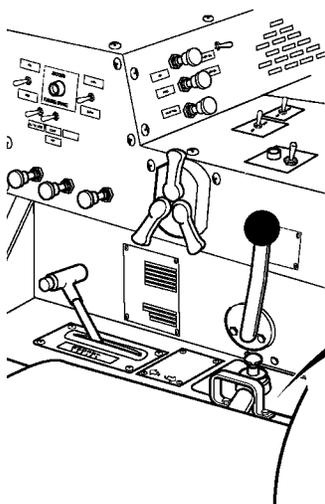
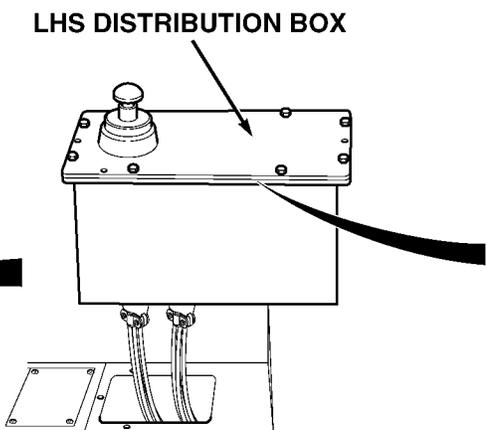
Malfunction	Test or Inspection	Corrective Action
LOAD HANDLING SYSTEM (LHS) (CONT)		
12. HOOK ARM DOES NOT UNLOAD IN MANUAL MODE (CONT).		
	 <p style="text-align: center;">LHS DISTRIBUTION BOX</p>	<ul style="list-style-type: none"> <input type="radio"/> AUTO LOAD IN <input type="radio"/> AUTO UNLOAD IN <input type="radio"/> MAN/AUTO MODE <input type="radio"/> MAN TRANSIT IN <input type="radio"/> UNLOAD OUT <input type="radio"/> LOAD OUT <input type="radio"/> AUX MODE IN <input type="radio"/> NO TRANSIT LIGHT <input type="radio"/> OVERLOAD LIGHT <input type="radio"/> HOOK ARM "A" SOL <input type="radio"/> MAIN RAM "B" SOL <input type="radio"/> HOOK ARM "B" SOL <input type="radio"/> MAIN RAM "A" SOL <input type="radio"/> +24V IN <input type="radio"/> HOOK ARM UP <input type="radio"/> FREE FLOW VALVE <input type="radio"/> HOOK ARM DOWN <input type="radio"/> TRANSIT VALVE <input type="radio"/> OVERLOAD IN
<u>WARNING</u>		
<p>Remove all jewelry such as rings, dog tags, bracelets, etc. If jewelry or tools contact positive electrical circuits, a direct short may result. Damage to equipment and injury or death to personnel may occur.</p>		
<u>CAUTION</u>		
<p>Do not allow the LHS distribution box assembly to hang from console by the wire connections to the distribution box assembly. Failure to comply will damage the wire connections.</p>		
Step 7.	<p>With engine switch ON and hydraulic selector in MAN H.A. position, check for appropriate LHS distribution box assembly indicator lights operation.</p>	
	<p>If HOOK ARM "A" SOL indicator lamp does not illuminate with joystick in UNLOAD position, replace LHS distribution box assembly (Para 4-34).</p>	

Organizational Maintenance Instructions (Cont)

4-18. TROUBLESHOOTING INSTRUCTIONS (CONT).

Table 4-3. Load Handling System (LHS) Troubleshooting (CONT)

Malfunction	Test or Inspection	Corrective Action
LOAD HANDLING SYSTEM (LHS) (CONT)		
12. HOOK ARM DOES NOT UNLOAD IN MANUAL MODE (CONT).		
<u>WARNING</u>		
<p>Remove all jewelry such as rings, dog tags, bracelets, etc. If jewelry or tools contact positive electrical circuits, a direct short may result. Damage to equipment and injury or death to personnel may occur.</p>		
Step 8.	<p>Check for continuity on wire 1464 at harness connector MC81 terminal D and chassis ground with hook arm up DC valve harness connector terminal 2 jumpered to chassis ground.</p>	
<p>If there is no continuity, repair wire 1464 or notify DS Maintenance.</p>		

Organizational Maintenance Instructions (Cont)

Table 4-3. Load Handling System (LHS) Troubleshooting (CONT)

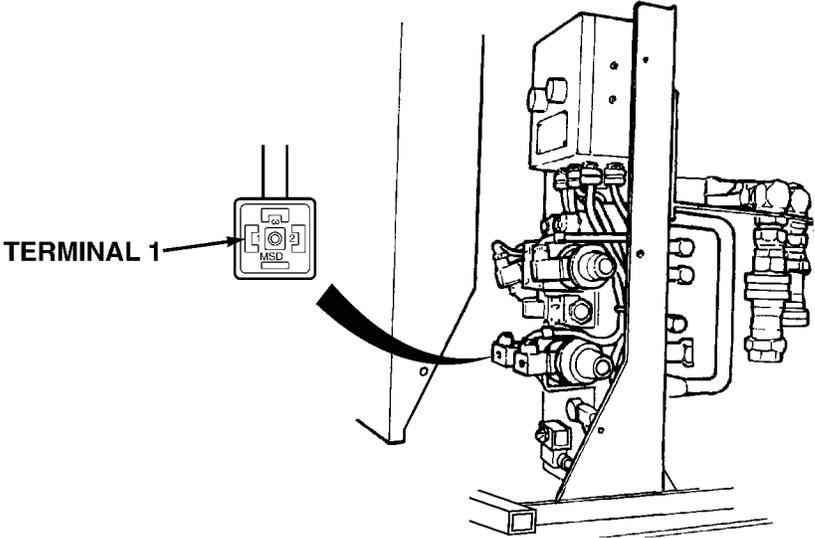
Malfunction	Test or Inspection	Corrective Action
LOAD HANDLING SYSTEM (LHS) (CONT)		
12. HOOK ARM DOES NOT UNLOAD IN MANUAL MODE (CONT).		
 <p>The diagram shows a side view of the hook arm assembly. A callout box labeled 'TERMINAL 1' points to a specific terminal on a connector within the assembly. The connector is a rectangular box with several terminals and is connected to the main assembly via a curved cable or hose.</p>		
<u>WARNING</u>		
<p>Remove all jewelry such as rings, dog tags, bracelets, etc. If jewelry or tools contact positive electrical circuits, a direct short may result. Damage to equipment and injury or death to personnel may occur.</p>		
<p>Step 9. Check for continuity on wire 1435 between hook arm up DC valve harness connector terminal 1 and chassis ground.</p>		
<p style="padding-left: 40px;">If there is no continuity, repair wire 1435.</p>		

Organizational Maintenance Instructions (Cont)

4-18. TROUBLESHOOTING INSTRUCTIONS (CONT).

Table 4-3. Load Handling System (LHS) Troubleshooting (CONT)

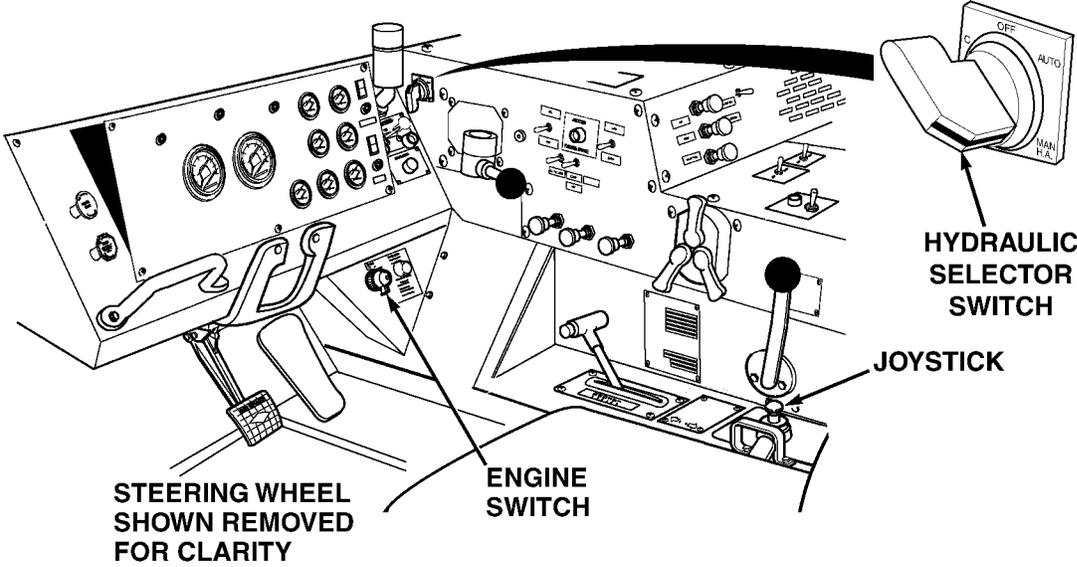
Malfunction	Test or Inspection	Corrective Action
LOAD HANDLING SYSTEM (LHS) (CONT)		
12. HOOK ARM DOES NOT UNLOAD IN MANUAL MODE (CONT).		
 <p>STEERING WHEEL SHOWN REMOVED FOR CLARITY</p> <p>ENGINE SWITCH</p> <p>JOYSTICK</p> <p>HYDRAULIC SELECTOR SWITCH</p>		
<u>WARNING</u>		
<p>Keep clear of equipment when equipment is being raised or lowered. Equipment may fall and cause serious injury or death to personnel.</p>		
<p>Step 10. Check for proper hook arm unload in manual mode.</p>		
<p>If hook arm does not unload, fault not corrected. Notify DS Maintenance.</p>		

Organizational Maintenance Instructions (Cont)

Table 4-3. Load Handling System (LHS) Troubleshooting (CONT)

Malfunction	Test or Inspection	Corrective Action
LOAD HANDLING SYSTEM (LHS) (CONT)		
13. HOOK ARM DOES NOT LOAD IN MANUAL MODE.		
<u>WARNING</u>		
<p>The LHS hydraulic system operates at oil pressures up to 1,725 psi (11 894 kPa). Never disconnect any hydraulic line or fitting without first dropping pressure to zero. Failure to comply may result in serious injury or death to personnel.</p>		
<p>Step 1. Check LHS hydraulic hoses 2881, 2882, 2891, and 2892 for damage, crimps, or leaks, and check fittings for leaks.</p>		
<p>If hoses are damaged, crimped, or leaking, tighten fittings or replace hoses.</p>		

Organizational Maintenance Instructions (Cont)

4-18. TROUBLESHOOTING INSTRUCTIONS (CONT).

Table 4-3. Load Handling System (LHS) Troubleshooting (CONT)

Malfunction	Test or Inspection	Corrective Action
LOAD HANDLING SYSTEM (LHS) (CONT)		
13. HOOK ARM DOES NOT LOAD IN MANUAL MODE (CONT).		
<p>The diagram illustrates the hydraulic circuit for the LHS. It shows a Diverter Manifold connected to Hook Arm Manifold LH and Main Cylinder Manifold LH. The Hook Arm Manifold LH is connected to Hook Arm Tubes, which are in turn connected to Hook Arm Manifold RH. The Main Cylinder Manifold LH is connected to Main Cylinder Manifold RH. A Compression Tube is connected to both the Main Cylinder Manifold LH and RH. The LHS Main Manifold is connected to the Compression Tube and various hoses (2887, 2888, 2889, 2866, 2890, 902, 2917). The system is connected to Axle No. 4 and Axle No. 2.</p>		
<u>WARNING</u>		
<p>The LHS hydraulic system operates at oil pressures up to 1,725 psi (11 894 kPa). Never disconnect any hydraulic line or fitting without first dropping pressure to zero. Failure to comply may result in serious injury or death to personnel.</p>		
Step 2.	<p>Check LHS hydraulic tubes 2881, 2882, 2891, and 2892 for damage, crimps, or leaks, and check fittings for leaks.</p>	
	<p>If tubes are leaking at the fittings, tighten the fittings.</p>	
	<p>If tubes are damaged, crimped, or leaking, notify DS Maintenance.</p>	

Organizational Maintenance Instructions (Cont)

Table 4-3. Load Handling System (LHS) Troubleshooting (CONT)

Malfunction	Test or Inspection	Corrective Action
LOAD HANDLING SYSTEM (LHS) (CONT)		
13. HOOK ARM DOES NOT LOAD IN MANUAL MODE (CONT).		
WARNING		
<p>Remove all jewelry such as rings, dog tags, bracelets, etc. If jewelry or tools contact positive electrical circuits, a direct short may result. Damage to equipment and injury or death to personnel may occur.</p>		
NOTE		
<p>Only remove center screw on engine side of LHS control box cover.</p>		
Step 3.	<p>Check for 22 to 28 Vdc at hook arm down directional control (DC) valve harness connector terminal 2 with ENGINE switch ON, hydraulic selector switch in MAN H.A. position, and joystick in LOAD position.</p>	
	<p>If there are 22 to 28 Vdc, go to Step 9. of this Fault.</p>	
	<p>If Vdc measurement is below specification, go to Step 4. of this Fault.</p>	

Organizational Maintenance Instructions (Cont)

4-18. TROUBLESHOOTING INSTRUCTIONS (CONT).

Table 4-3. Load Handling System (LHS) Troubleshooting (CONT)

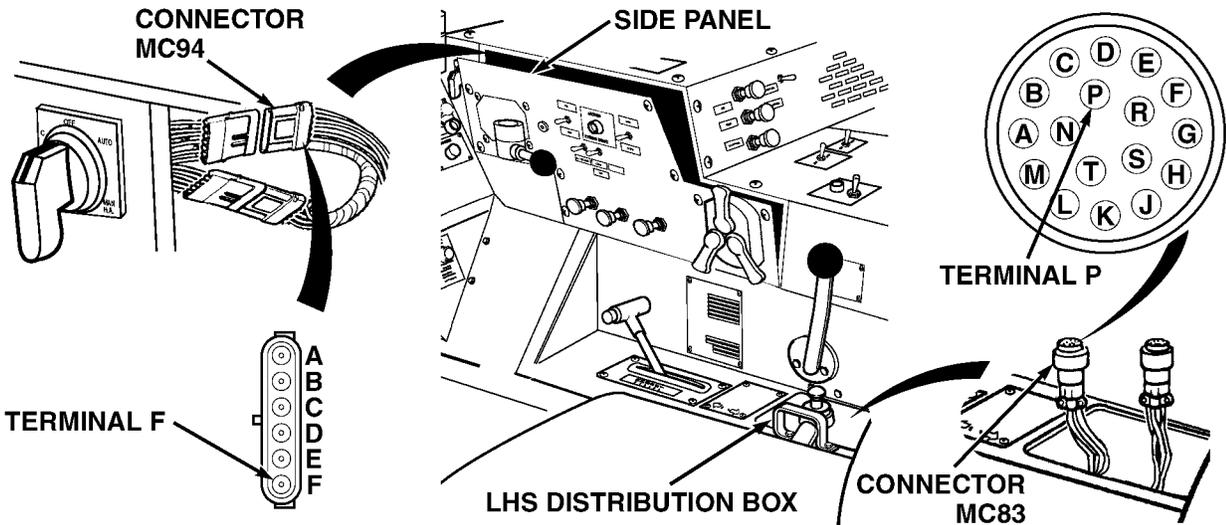
Malfunction	Test or Inspection	Corrective Action
LOAD HANDLING SYSTEM (LHS) (CONT)		
13. HOOK ARM DOES NOT LOAD IN MANUAL MODE (CONT).	 <p>The diagram illustrates the electrical connection for troubleshooting a hook arm that does not load in manual mode. It shows the LHS Distribution Box, the Side Panel, and two connectors: MC94 and MC83. Terminal F on connector MC94 is connected to terminal P on connector MC83. A circular terminal layout diagram shows terminal P is located between terminals N and R, and between terminals C and E.</p>	
WARNING		
<p>Remove all jewelry such as rings, dog tags, bracelets, etc. If jewelry or tools contact positive electrical circuits, a direct short may result. Damage to equipment and injury or death to personnel may occur.</p>		
Step 4.	<p>Check for continuity on wire 1490 between harness connector MC83 terminal P and harness connector MC94 terminal F.</p>	
<p>If there is no continuity, repair wire 1490 or notify DS Maintenance.</p>		

Organizational Maintenance Instructions (Cont)

Table 4-3. Load Handling System (LHS) Troubleshooting (CONT)

Malfunction	Test or Inspection	Corrective Action
LOAD HANDLING SYSTEM (LHS) (CONT)		
13. HOOK ARM DOES NOT LOAD IN MANUAL MODE (CONT).		
<u>WARNING</u>		
<p>Remove all jewelry such as rings, dog tags, bracelets, etc. If jewelry or tools contact positive electrical circuits, a direct short may result. Damage to equipment and injury or death to personnel may occur.</p>		
Step 5.	<p>Check for continuity on wire 1486 between harness connector MC83 terminal C and harness connector MC94 terminal B.</p>	
<p>If there is no continuity, repair wire 1486 or notify DS Maintenance.</p>		

Organizational Maintenance Instructions (Cont)

4-18. TROUBLESHOOTING INSTRUCTIONS (CONT).

Table 4-3. Load Handling System (LHS) Troubleshooting (CONT)

Malfunction	Test or Inspection	Corrective Action
LOAD HANDLING SYSTEM (LHS) (CONT)		
13. HOOK ARM DOES NOT LOAD IN MANUAL MODE (CONT).		
<u>WARNING</u>		
<p>Remove all jewelry such as rings, dog tags, bracelets, etc. If jewelry or tools contact positive electrical circuits, a direct short may result. Damage to equipment and injury or death to personnel may occur.</p>		
Step 6.	<p>Check for continuity between hydraulic selector switch harness connector MC94 terminal B and terminal F with switch in MAN H.A. position.</p>	
<p>If there is no continuity, replace hydraulic selector switch (Para 4-31).</p>		

Organizational Maintenance Instructions (Cont)

Table 4-3. Load Handling System (LHS) Troubleshooting (CONT)

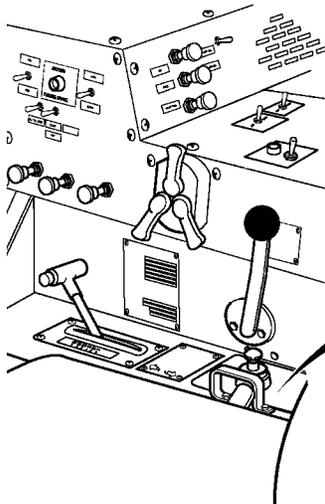
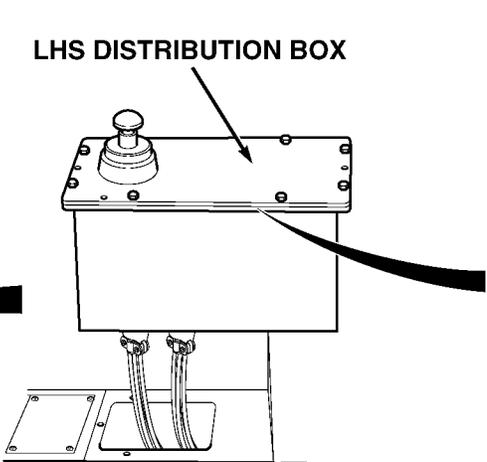
Malfunction	Test or Inspection	Corrective Action
LOAD HANDLING SYSTEM (LHS) (CONT)		
13. HOOK ARM DOES NOT LOAD IN MANUAL MODE (CONT).		
	 <p style="text-align: center;">LHS DISTRIBUTION BOX</p>	<ul style="list-style-type: none"> <input type="radio"/> AUTO LOAD IN <input type="radio"/> AUTO UNLOAD IN <input type="radio"/> MAN/AUTO MODE <input type="radio"/> MAN TRANSIT IN <input type="radio"/> UNLOAD OUT <input type="radio"/> LOAD OUT <input type="radio"/> AUX MODE IN <input type="radio"/> NO TRANSIT LIGHT <input type="radio"/> OVERLOAD LIGHT <input type="radio"/> HOOK ARM "A" SOL <input type="radio"/> MAIN RAM "B" SOL <input type="radio"/> HOOK ARM "B" SOL <input type="radio"/> MAIN RAM "A" SOL <input type="radio"/> +24V IN <input type="radio"/> HOOK ARM UP <input type="radio"/> FREE FLOW VALVE <input type="radio"/> HOOK ARM DOWN <input type="radio"/> TRANSIT VALVE <input type="radio"/> OVERLOAD IN
<u>WARNING</u>		
<p>Remove all jewelry such as rings, dog tags, bracelets, etc. If jewelry or tools contact positive electrical circuits, a direct short may result. Damage to equipment and injury or death to personnel may occur.</p>		
<u>CAUTION</u>		
<p>Do not allow the LHS distribution box assembly to hang from console by the wire connections to the distribution box assembly. Failure to comply will damage the wire connections.</p>		
Step 7.	<p>With engine switch on and hydraulic selector switch in MAN H.A. positron, check appropriate LHS distribution box assembly indicator light operation.</p>	
<p style="padding-left: 40px;">If HOOK ARM "B" SOL indicator lamp does not illuminate with joystick in LOAD position, replace LHS distribution box assembly (Para 4-34).</p>		

Organizational Maintenance Instructions (Cont)

4-18. TROUBLESHOOTING INSTRUCTIONS (CONT).

Table 4-3. Load Handling System (LHS) Troubleshooting (CONT)

Malfunction	Test or Inspection	Corrective Action
LOAD HANDLING SYSTEM (LHS) (CONT)		
13. HOOK ARM DOES NOT LOAD IN MANUAL MODE (CONT).	<p>The diagram illustrates the electrical connection for troubleshooting a hook arm that does not load in manual mode. It shows the LHS Control Box on the right, connected to a Hook Arm Down DC Valve Harness Connector. This connector has two terminals, Terminal 1 and Terminal 2. Terminal 2 is connected to Terminal B of Connector MC81. A circular terminal diagram for Connector MC81 shows terminals A through S. Terminal B is specifically highlighted. The diagram also shows the physical location of the connectors on the control panel and the harness.</p>	
<u>WARNING</u>		
<p>Remove all jewelry such as rings, dog tags, bracelets, etc. If jewelry or tools contact positive electrical circuits, a direct short may result. Damage to equipment and injury or death to personnel may occur.</p>		
Step 8.	<p>Check for continuity on wire 1467 at harness connector MC81 terminal B chassis ground with hook arm down DC valve harness connector terminal 2 jumpered to ground.</p>	
<p>If there is no continuity, repair wire 1467 or notify DS Maintenance.</p>		

Organizational Maintenance Instructions (Cont)

Table 4-3. Load Handling System (LHS) Troubleshooting (CONT)

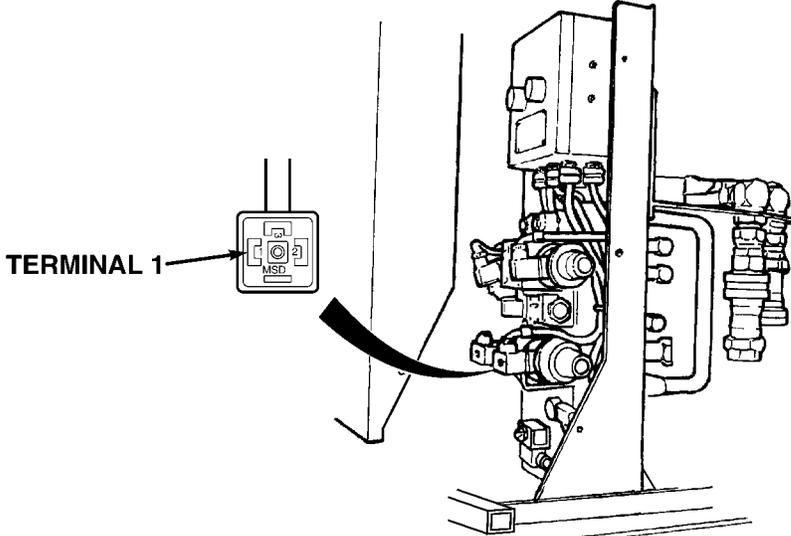
Malfunction	Test or Inspection	Corrective Action
LOAD HANDLING SYSTEM (LHS) (CONT)		
13. HOOK ARM DOES NOT LOAD IN MANUAL MODE (CONT).		
 <p>The diagram shows a side view of a hook arm assembly. A terminal block is shown to the left of the main assembly, with an arrow pointing to a terminal labeled '1'. The terminal block also has a terminal labeled 'MSD'. The hook arm assembly includes various mechanical components, a control panel, and a valve harness connector.</p>		
<u>WARNING</u>		
<p>Remove all jewelry such as rings, dog tags, bracelets, etc. If jewelry or tools contact positive electrical circuits, a direct short may result. Damage to equipment and injury or death to personnel may occur.</p>		
Step 9.	<p>Check for continuity on wire 1435 between hook arm down DC valve harness connector terminal 1 and chassis ground.</p>	<p>If there is no continuity, repair wire 1435 or notify DS Maintenance.</p>

Organizational Maintenance Instructions (Cont)

4-18. TROUBLESHOOTING INSTRUCTIONS (CONT).

Table 4-3. Load Handling System (LHS) Troubleshooting (CONT)

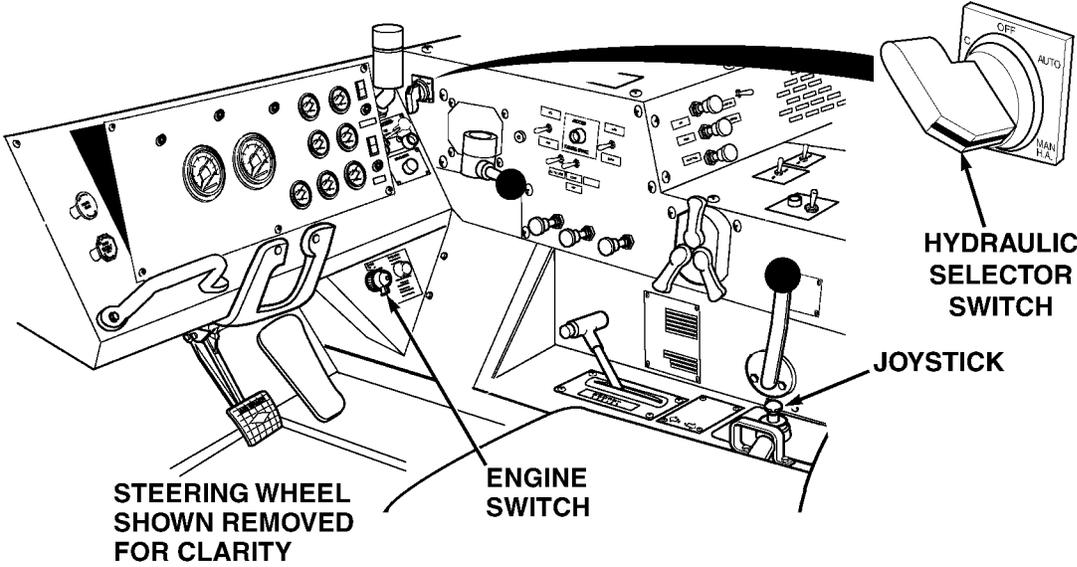
Malfunction	Test or Inspection	Corrective Action
LOAD HANDLING SYSTEM (LHS) (CONT)		
13. HOOK ARM DOES NOT LOAD IN MANUAL MODE (CONT).		
		
<p>Step 10. Check for proper hook arm load in manual mode.</p> <p>If hook arm does not load, fault not corrected. Notify DS Maintenance.</p>		

Organizational Maintenance Instructions (Cont)

Table 4-3. Load Handling System (LHS) Troubleshooting (CONT)

Malfunction	Test or Inspection	Corrective Action
LOAD HANDLING SYSTEM (LHS) (CONT)		
14. MAIN FRAME DOES NOT UNLOAD IN MANUAL MODE.		
<u>WARNING</u>		
<p>The LHS hydraulic system operates at oil pressures up to 1,725 psi (11 894 kPa). Never disconnect any hydraulic line or fitting without first dropping pressure to zero. Failure to comply may result in serious injury or death to personnel.</p>		
Step 1.	<p>Check LHS hydraulic hoses 2887, 2888, 2889, 2890, 2666, and 2588 for damage, crimps, or leaks, and check fittings for leaks.</p>	
	<p>If hoses are damaged, crimped, or leaking, tighten fittings or replace hoses.</p>	

Organizational Maintenance Instructions (Cont)

4-18. TROUBLESHOOTING INSTRUCTIONS (CONT).

Table 4-3. Load Handling System (LHS) Troubleshooting (CONT)

Malfunction	Test or Inspection	Corrective Action
LOAD HANDLING SYSTEM (LHS) (CONT)		
14. MAIN FRAME DOES NOT UNLOAD IN MANUAL MODE (CONT).		
WARNING		
<p>Remove all jewelry such as rings, dog tags, bracelets, etc. If jewelry or tools contact positive electrical circuits, a direct short may result. Damage to equipment and injury or death to personnel may occur.</p>		
NOTE		
<p>Only remove center screw on engine side of LHS control box cover.</p>		
<p>Step 2. Check for 22 to 28 Vdc at main frame up directional control (DC) valve harness connector terminal 2 with ENGINE switch ON, hydraulic selector switch in MAN M.F. position, and joystick in UNLOAD position.</p>		
<p>If Vdc measurement is below specification, go to Step 3. of this Fault.</p>		
<p>If there are 22 to 28 Vdc, go to Step 10. of this Fault.</p>		

Organizational Maintenance Instructions (Cont)

Table 4-3. Load Handling System (LHS) Troubleshooting (CONT)

Malfunction	Test or Inspection	Corrective Action
LOAD HANDLING SYSTEM (LHS) (CONT)		
14. MAIN FRAME DOES NOT UNLOAD IN MANUAL MODE (CONT).		
<p>The diagram illustrates the electrical connections for the LHS. It shows a side panel with various controls and connectors. Connector MC94 is connected to terminal E. Terminal N is connected to connector MC83. A circular terminal block is shown with terminals A through S. Terminal N is highlighted.</p>		
<u>WARNING</u>		
<p>Remove all jewelry such as rings, dog tags, bracelets, etc. If jewelry or tools contact positive electrical circuits, a direct short may result. Damage to equipment and injury or death to personnel may occur.</p>		
<p>Step 3. Check for continuity on wire 1489 between harness connector MC94 terminal E and harness connector MC83 terminal N.</p>		
<p style="text-align: center;">If there is no continuity, repair wire 1489 or notify DS Maintenance.</p>		

Organizational Maintenance Instructions (Cont)

4-18. TROUBLESHOOTING INSTRUCTIONS (CONT).

Table 4-3. Load Handling System (LHS) Troubleshooting (CONT)

Malfunction	Test or Inspection	Corrective Action
LOAD HANDLING SYSTEM (LHS) (CONT)		
1414. MAIN FRAME DOES NOT UNLOAD IN MANUAL MODE (CONT).		
<u>WARNING</u>		
<p>Remove all jewelry such as rings, dog tags, bracelets, etc. If jewelry or tools contact positive electrical circuits, a direct short may result. Damage to equipment and injury or death to personnel may occur.</p>		
<p>Step 4. Check for continuity on wire 1480 between harness connector MC93 terminal B and harness connector MC83 terminal D.</p>		
<p style="padding-left: 40px;">If there is no continuity, repair wire 1480 or notify DS Maintenance.</p>		

Organizational Maintenance Instructions (Cont)

Table 4-3. Load Handling System (LHS) Troubleshooting (CONT)

Malfunction	Test or Inspection	Corrective Action
LOAD HANDLING SYSTEM (LHS) (CONT)		
14. MAIN FRAME DOES NOT UNLOAD IN MANUAL MODE (CONT).		
<u>WARNING</u>		
<p>Remove all jewelry such as rings, dog tags, bracelets, etc. If jewelry or tools contact positive electrical circuits, a direct short may result. Damage to equipment and injury or death to personnel may occur.</p>		
Step 5.	<p>Check for continuity between hydraulic selector switch connector MC94 terminal E and switch connector MC93 terminal B with switch in MAN M.F. position.</p>	
<p style="padding-left: 40px;">If there is no continuity, replace hydraulic selector switch (Para 4-31).</p>		

Organizational Maintenance Instructions (Cont)

4-18. TROUBLESHOOTING INSTRUCTIONS (CONT).

Table 4-3. Load Handling System (LHS) Troubleshooting (CONT)

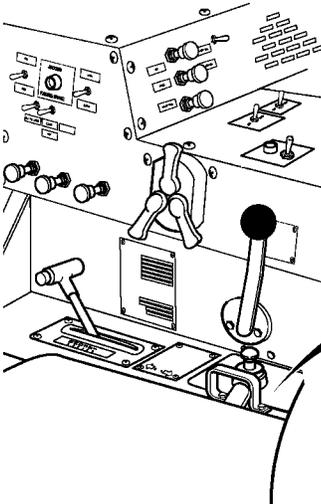
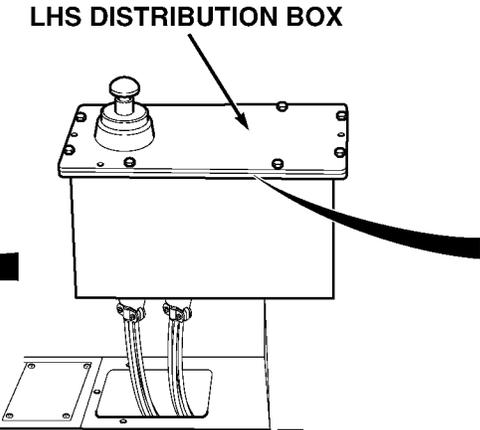
Malfunction	Test or Inspection	Corrective Action
LOAD HANDLING SYSTEM (LHS) (CONT)		
14. MAIN FRAME DOES NOT UNLOAD IN MANUAL MODE (CONT).		
	 <p style="text-align: center;">LHS DISTRIBUTION BOX</p>	<ul style="list-style-type: none"> <input type="radio"/> AUTO LOAD IN <input type="radio"/> AUTO UNLOAD IN <input type="radio"/> MAN/AUTO MODE <input type="radio"/> MAN TRANSIT IN <input type="radio"/> UNLOAD OUT <input type="radio"/> LOAD OUT <input type="radio"/> AUX MODE IN <input type="radio"/> NO TRANSIT LIGHT <input type="radio"/> OVERLOAD LIGHT <input type="radio"/> HOOK ARM "A" SOL <input type="radio"/> MAIN RAM "B" SOL <input type="radio"/> HOOK ARM "B" SOL <input type="radio"/> MAIN RAM "A" SOL <input type="radio"/> +24V IN <input type="radio"/> HOOK ARM UP <input type="radio"/> FREE FLOW VALVE <input type="radio"/> HOOK ARM DOWN <input type="radio"/> TRANSIT VALVE <input type="radio"/> OVERLOAD IN
<u>WARNING</u>		
<p>Remove all jewelry such as rings, dog tags, bracelets, etc. If jewelry or tools contact positive electrical circuits, a direct short may result. Damage to equipment and injury or death to personnel may occur.</p>		
<u>CAUTION</u>		
<p>Do not allow the LHS distribution box assembly to hang from console wire connections to the distribution box assembly. Failure to comply will damage the wire connections.</p>		
Step 6.	<p>With engine switch ON and hydraulic selector switch in MAN M.F. positron, check for appropriate LHS distribution box assembly indicator light operation.</p>	
<p>If MAIN RAM "A" SOL indicator lamp does not illuminate with joystick in UNLOAD position replace LHS distribution box assembly (Para 4-34).</p>		

Organizational Maintenance Instructions (Cont)

Table 4-3. Load Handling System (LHS) Troubleshooting (CONT)

Malfunction	Test or Inspection	Corrective Action
LOAD HANDLING SYSTEM (LHS) (CONT)		
14. MAIN FRAME DOES NOT UNLOAD IN MANUAL MODE (CONT).		
<u>WARNING</u>		
<p>Remove all jewelry such as rings, dog tags, bracelets, etc. If jewelry or tools contact positive electrical circuits, a direct short may result. Damage to equipment and injury or death to personnel may occur.</p>		
<u>CAUTION</u>		
<p>When opening the main junction box, do not pull or allow front of junction box to hang by the wire connections. Failure to comply will damage the wire connections.</p>		
Step 7.	<p>Check for continuity at main junction box main frame lockout relay R29 terminals 87A and 30.</p>	<p>If there is no continuity, replace main frame lockout relay R29 (Para 4-38).</p>
Step 8.	<p>Check for continuity at main junction box main frame lockout relay R29 terminals 85 and 86.</p>	<p>If there is no continuity, replace main frame lockout relay R29 (Para 4-38).</p>

Organizational Maintenance Instructions (Cont)

4-18. TROUBLESHOOTING INSTRUCTIONS (CONT).

Table 4-3. Load Handling System (LHS) Troubleshooting (CONT)

Malfunction	Test or Inspection	Corrective Action
LOAD HANDLING SYSTEM (LHS) (CONT)		
14. MAIN FRAME DOES NOT UNLOAD IN MANUAL MODE (CONT).		
<u>WARNING</u>		
<p>Remove all jewelry such as rings, dog tags, bracelets, etc. If jewelry or tools contact positive electrical circuits, a direct short may result. Damage to equipment and injury or death to personnel may occur.</p>		
Step 9.	<p>Check for continuity on wire 1465 between main frame up DC valve harness connector terminal 2 and harness connector MC81 terminal A.</p>	
<p>If there is no continuity, repair wire 1465 or notify DS Maintenance.</p>		

Organizational Maintenance Instructions (Cont)

Table 4-3. Load Handling System (LHS) Troubleshooting (CONT)

Malfunction	Test or Inspection	Corrective Action
LOAD HANDLING SYSTEM (LHS) (CONT)		
14. MAIN FRAME DOES NOT UNLOAD IN MANUAL MODE (CONT).		
<u>WARNING</u>		
<p>Remove all jewelry such as rings, dog tags, bracelets, etc. If jewelry or tools contact positive electrical circuits, a direct short may result. Damage to equipment and injury or death to personnel may occur.</p>		
<p>Step 10. Check continuity on wire 1435 between main frame up DC valve harness connector terminal 1 and chassis ground.</p>		
<p style="padding-left: 40px;">If there is no continuity, repair wire 1435 or notify DS Maintenance.</p>		

Organizational Maintenance Instructions (Cont)

4-18. TROUBLESHOOTING INSTRUCTIONS (CONT).

Table 4-3. Load Handling System (LHS) Troubleshooting (CONT)

Malfunction	Test or Inspection	Corrective Action
LOAD HANDLING SYSTEM (LHS) (CONT)		
14. MAIN FRAME DOES NOT UNLOAD IN MANUAL MODE (CONT).		
<p>STEERING WHEEL SHOWN REMOVED FOR CLARITY</p> <p>ENGINE SWITCH</p> <p>JOYSTICK</p> <p>HYDRAULIC SELECTOR SWITCH</p>		
Step 11. Check for proper operation of the main frame unload in manual mode.		
If main frame does not unload, fault not corrected. Notify DS Maintenance.		

Organizational Maintenance Instructions (Cont)

Table 4-3. Load Handling System (LHS) Troubleshooting (CONT)

Malfunction	Test or Inspection	Corrective Action
LOAD HANDLING SYSTEM (LHS) (CONT)		
15. MAIN FRAME DOES NOT LOAD IN MANUAL MODE.		
WARNING		
<p>The LHS hydraulic system operates at oil pressures up to 1,725 psi (11 894 kPa). Never disconnect any hydraulic line or fitting without first dropping pressure to zero. Failure to comply may result in serious injury or death to personnel.</p>		
<p>Step 1. Check LHS hydraulic hoses 2887, 2888, 2889, 2890, 2666, and 2588 for damage, leaks, and fittings that are leaking.</p>		
<p style="padding-left: 40px;">If hoses are damaged, crimped, or leaking tighten, fittings or replace hoses.</p>		

Organizational Maintenance Instructions (Cont)

4-18. TROUBLESHOOTING INSTRUCTIONS (CONT).

Table 4-3. Load Handling System (LHS) Troubleshooting (CONT)

Malfunction	Test or Inspection	Corrective Action
LOAD HANDLING SYSTEM (LHS) (CONT)		
15. MAIN FRAME DOES NOT LOAD IN MANUAL MODE (CONT).		
<p>The diagram illustrates the electrical and hydraulic components for troubleshooting the main frame loading issue. On the left, a control panel features a 'HYDRAULIC SELECTOR SWITCH' and an 'ENGINE SWITCH'. A 'HARNESS CONNECTOR' is shown with 'TERMINAL 1' and 'TERMINAL 2'. A thick black cable connects 'TERMINAL 1' to the 'MAIN FRAME DOWN DC VALVE' on the right side of the equipment.</p>		
<u>WARNING</u>		
<p>Remove all jewelry such as rings, dog tags, bracelets, etc. If jewelry or tools contact positive electrical circuits, a direct short may result. Damage to equipment and injury or death to personnel may occur.</p>		
<u>NOTE</u>		
<p>Only remove center screw on engine side of LHS control box cover.</p>		
Step 2.	<p>Check for 22 to 28 Vdc at main frame down directional control (DC) valve harness connector terminal 2 with ENGINE switch ON, hydraulic selector switch in MAN M.F. position and joystick in LOAD position.</p>	
	<p>If Vdc measurement is below specification, go to Step 3. of this Fault.</p>	
	<p>If there are 22 to 28 Vdc, go to Step 8. of this Fault.</p>	

Organizational Maintenance Instructions (Cont)

Table 4-3. Load Handling System (LHS) Troubleshooting (CONT)

Malfunction	Test or Inspection	Corrective Action
LOAD HANDLING SYSTEM (LHS) (CONT)		
15. MAIN FRAME DOES NOT LOAD IN MANUAL MODE (CONT).		
<p>The diagram illustrates the electrical connection for troubleshooting. On the left, Connector MC94 is shown with terminals labeled A through F. On the right, Connector MC83 is shown with terminals labeled A through P. A circular terminal block diagram shows terminal P highlighted with an arrow. A 'SIDE PANEL' is also labeled. Arrows indicate the connection path between the connectors.</p>		
WARNING		
<p>Remove all jewelry such as rings, dog tags, bracelets, etc. If jewelry or tools contact positive electrical circuits, a direct short may result. Damage to equipment and injury or death to personnel may occur.</p>		
<p>Step 3. Check for continuity on wire 1490 between harness connector MC94 terminal F and harness connector MC83 terminal P.</p>		
<p style="padding-left: 40px;">If there is no continuity, repair wire 1490 or notify DS Maintenance.</p>		

Organizational Maintenance Instructions (Cont)

4-18. TROUBLESHOOTING INSTRUCTIONS (CONT).

Table 4-3. Load Handling System (LHS) Troubleshooting (CONT)

Malfunction	Test or Inspection	Corrective Action
LOAD HANDLING SYSTEM (LHS) (CONT)		
15. MAIN FRAME DOES NOT LOAD IN MANUAL MODE (CONT).		
<u>WARNING</u>		
<p>Remove all jewelry such as rings, dog tags, bracelets, etc. If jewelry or tools contact positive electrical circuits, a direct short may result. Damage to equipment and injury or death to personnel may occur.</p>		
<p>Step 4. Check for continuity on wire 1481 between harness connector MC93 terminal C and harness connector MC83 terminal B.</p>		
<p style="padding-left: 40px;">If there is no continuity, repair wire 1481 or notify DS Maintenance.</p>		

Organizational Maintenance Instructions (Cont)

Table 4-3. Load Handling System (LHS) Troubleshooting (CONT)

Malfunction	Test or Inspection	Corrective Action
LOAD HANDLING SYSTEM (LHS) (CONT)		
15. MAIN FRAME DOES NOT LOAD IN MANUAL MODE (CONT).		
<u>WARNING</u>		
<p>Remove all jewelry such as rings, dog tags, bracelets, etc. If jewelry or tools contact positive electrical circuits, a direct short may result. Damage to equipment and injury or death to personnel may occur.</p>		
Step 5.	<p>Check for continuity between hydraulic selector switch connector MC94 terminal F and switch connector MC93 terminal C with switch in MAN M.F. position.</p>	<p>If there is no continuity, replace hydraulic selector switch (Para 4-31).</p>

Organizational Maintenance Instructions (Cont)

4-18. TROUBLESHOOTING INSTRUCTIONS (CONT).

Table 4-3. Load Handling System (LHS) Troubleshooting (CONT)

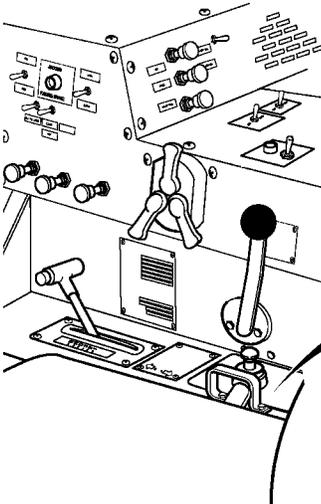
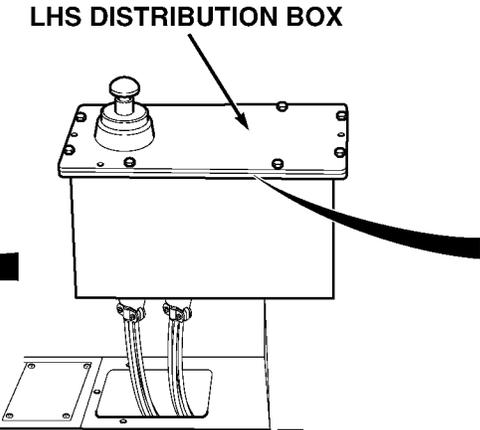
Malfunction	Test or Inspection	Corrective Action
LOAD HANDLING SYSTEM (LHS) (CONT)		
15. MAIN FRAME DOES NOT LOAD IN MANUAL MODE (CONT).		
	 <p style="text-align: center;">LHS DISTRIBUTION BOX</p>	<ul style="list-style-type: none"> <input type="radio"/> AUTO LOAD IN <input type="radio"/> AUTO UNLOAD IN <input type="radio"/> MAN/AUTO MODE <input type="radio"/> MAN TRANSIT IN <input type="radio"/> UNLOAD OUT <input type="radio"/> LOAD OUT <input type="radio"/> AUX MODE IN <input type="radio"/> NO TRANSIT LIGHT <input type="radio"/> OVERLOAD LIGHT <input type="radio"/> HOOK ARM "A" SOL <input type="radio"/> MAIN RAM "B" SOL <input type="radio"/> HOOK ARM "B" SOL <input type="radio"/> MAIN RAM "A" SOL <input type="radio"/> +24V IN <input type="radio"/> HOOK ARM UP <input type="radio"/> FREE FLOW VALVE <input type="radio"/> HOOK ARM DOWN <input type="radio"/> TRANSIT VALVE <input type="radio"/> OVERLOAD IN
<u>WARNING</u>		
<p>Remove all jewelry such as rings, dog tags, bracelets, etc. If jewelry or tools contact positive electrical circuits, a direct short may result. Damage to equipment and injury or death to personnel may occur.</p>		
<u>CAUTION</u>		
<p>Do not allow the LHS distribution box assembly to hang from console by the wire connections to the distribution box assembly. Failure to comply will damage the wire connections.</p>		
Step 6.	<p>With engine switch ON and hydraulic selector in MAN M.F. position, check for appropriate LHS distribution box assembly indicator light operation.</p>	
<p style="padding-left: 40px;">If MAIN RAM B indicator lamp does not illuminate with joystick in LOAD position, replace LHS distribution box assembly (Para 4-34).</p>		

Organizational Maintenance Instructions (Cont)

Table 4-3. Load Handling System (LHS) Troubleshooting (CONT)

Malfunction	Test or Inspection	Corrective Action
LOAD HANDLING SYSTEM (LHS) (CONT)		
15. MAIN FRAME DOES NOT LOAD IN MANUAL MODE (CONT).		
<u>WARNING</u>		
<p>Remove all jewelry such as rings, dog tags, bracelets, etc. If jewelry or tools contact positive electrical circuits, a direct short may result. Damage to equipment and injury or death to personnel may occur.</p>		
<p>Step 7. Check for continuity on wire 1468 at harness connector MC81 terminal C and chassis ground with main frame down DC valve harness connector terminal 2 jumpered to chassis ground.</p>		
<p style="text-align: center;">If there is no continuity, repair wire 1468 or notify DS Maintenance.</p>		

Organizational Maintenance Instructions (Cont)

4-18. TROUBLESHOOTING INSTRUCTIONS (CONT).

Table 4-3. Load Handling System (LHS) Troubleshooting (CONT)

Malfunction	Test or Inspection	Corrective Action
LOAD HANDLING SYSTEM (LHS) (CONT)		
15. MAIN FRAME DOES NOT LOAD IN MANUAL MODE (CONT).		
<p>The diagram shows a side view of a mechanical assembly. On the left, a square harness connector is shown with two wires extending from it. One wire is labeled 'TERMINAL 1'. A thick black cable runs from this connector to a larger, more complex component on the right, which is labeled 'MAIN FRAME DOWN DC VALVE'. The connector has a small square symbol with 'MSD' inside it. The main frame component has various electrical terminals and connectors on its side.</p>		
<u>WARNING</u>		
<p>Remove all jewelry such as rings, dog tags, bracelets, etc. If jewelry or tools contact positive electrical circuits, a direct short may result. Damage to equipment and injury or death to personnel may occur.</p>		
Step 8.	<p>Check for continuity on wire 1435 between main frame down DC valve harness connector terminal 1 and ground.</p>	<p>If there is no continuity, repair wire 1435 or notify DS Maintenance.</p>

Organizational Maintenance Instructions (Cont)

Table 4-3. Load Handling System (LHS) Troubleshooting (CONT)

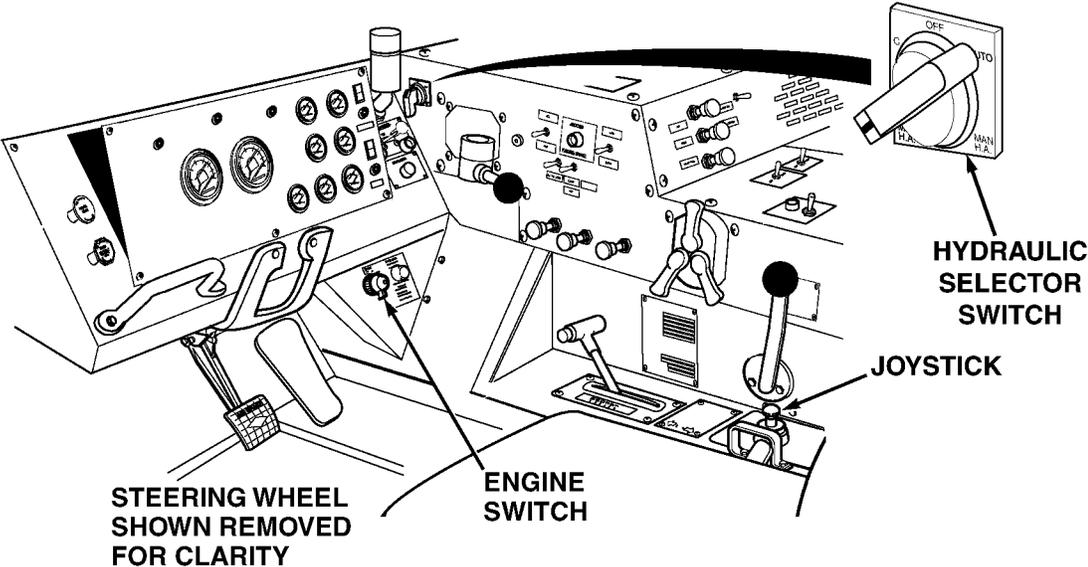
Malfunction	Test or Inspection	Corrective Action
LOAD HANDLING SYSTEM (LHS) (CONT)		
15. MAIN FRAME DOES NOT LOAD IN MANUAL MODE (CONT).		
		
<p>Step 9. Check main frame for proper operation in manual mode.</p> <p style="padding-left: 40px;">If main frame does not load, fault not corrected. Notify DS Maintenance.</p>		

Organizational Maintenance Instructions (Cont)

4-18. TROUBLESHOOTING INSTRUCTIONS (CONT).

Table 4-3. Load Handling System (LHS) Troubleshooting (CONT)

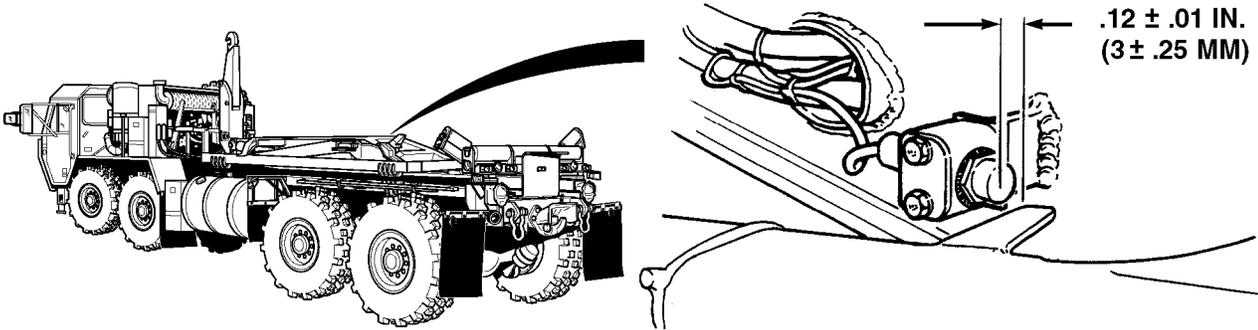
Malfunction	Test or Inspection	Corrective Action
LOAD HANDLING SYSTEM (LHS) (CONT)		
16. LHS DOES NOT LOAD IN AUTO MODE.		
		
Step 1.	<p>Check clearance between proximity switch (main frame down) and compression frame $.12 \pm .01$ in. ($3 \pm .25$ mm) with main frame down completely.</p>	
<p>If clearance is more than .13 in. (3.3 mm) or less than .11 in. (2.8 mm), proximity switch is not adjusted correctly. Adjust proximity switch (Para 4-37).</p>		

Organizational Maintenance Instructions (Cont)

Table 4-3. Load Handling System (LHS) Troubleshooting (CONT)

Malfunction	Test or Inspection	Corrective Action
LOAD HANDLING SYSTEM (LHS) (CONT)		
16. LHS DOES NOT LOAD IN AUTO MODE (CONT).		
<p>The diagram illustrates the LHS side panel and its electrical connections. On the left, a control knob is shown with 'MAN' and 'AUTO' positions. A cable connects this knob to a harness connector labeled 'CONNECTOR MC93'. This connector has terminals labeled 'A' through 'F'. Terminal 'F' is specifically labeled. On the right, another harness connector labeled 'CONNECTOR MC83' is shown with terminals 'H' and 'J'. Terminal 'H' is also specifically labeled. A circular terminal block is shown with terminals labeled 'A' through 'S'. An arrow points from terminal 'H' on the MC83 connector to terminal 'H' on the circular block. The side panel is shown with various controls and a 'SIDE PANEL' label.</p>		
<u>WARNING</u>		
<p>Remove all jewelry such as rings, dog tags, bracelets, etc. If jewelry or tools contact positive electrical circuits, a direct short may result. Damage to equipment and injury or death to personnel may occur.</p>		
Step 2.	<p>Check for continuity on wire 1484 between harness connector MC 93 terminal F and harness connector MC83 terminal H.</p>	
<p>If there is no continuity, repair wire 1484 or notify DS Maintenance.</p>		

Organizational Maintenance Instructions (Cont)

4-18. TROUBLESHOOTING INSTRUCTIONS (CONT).

Table 4-3. Load Handling System (LHS) Troubleshooting (CONT)

Malfunction	Test or Inspection	Corrective Action
LOAD HANDLING SYSTEM (LHS) (CONT)		
16. LHS DOES NOT LOAD IN AUTO MODE (CONT).		
<u>WARNING</u>		
<p>Remove all jewelry such as rings, dog tags, bracelets, etc. If jewelry or tools contact positive electrical circuits, a direct short may result. Damage to equipment and injury or death to personnel may occur.</p>		
Step 3.	<p>Check for continuity between hydraulic selector switch connector MC94 terminal F and switch connector MC93 terminal F.</p>	
<p>If there is no continuity, replace hydraulic selector switch (Para 4-31).</p>		

Organizational Maintenance Instructions (Cont)

Table 4-3. Load Handling System (LHS) Troubleshooting (CONT)

Malfunction	Test or Inspection	Corrective Action
LOAD HANDLING SYSTEM (LHS) (CONT)		
16. LHS DOES NOT LOAD IN AUTO MODE (CONT).		
<p>The diagram illustrates the electrical connection for terminal 9. At the top, a row of 18 terminals is shown, numbered 1 through 18. Below this, a side view of a truck is shown with an arrow pointing to terminal 9 on its chassis. To the right, a detailed view of the main junction box is shown, with an arrow pointing to terminal 9 inside the box. The label 'MAIN JUNCTION BOX' is placed above the junction box view.</p>		
WARNING		
<p>Remove all jewelry such as rings, dog tags, bracelets, etc. If jewelry or tools contact positive electrical circuits, a direct short may result. Damage to equipment and injury or death to personnel may occur.</p>		
NOTE		
<p>Only remove center screw on engine side of LHS main junction box cover.</p>		
Step 4.	<p>Check for 22 to 28 Vdc at main junction box terminal 9 with ENGINE switch in ON position.</p>	
	<p>If Vdc measurement is below specification, go to Fault 6.</p>	
	<p>If there are 22 to 28 Vdc, go to Step 5. of this Fault.</p>	

Organizational Maintenance Instructions (Cont)

4-18. TROUBLESHOOTING INSTRUCTIONS (CONT).

Table 4-3. Load Handling System (LHS) Troubleshooting (CONT)

Malfunction	Test or Inspection	Corrective Action
LOAD HANDLING SYSTEM (LHS) (CONT)		
16. LHS DOES NOT LOAD IN AUTO MODE (CONT).		
<u>WARNING</u>		
<p>Remove all jewelry such as rings, dog tags, bracelets, etc. If jewelry or tools contact positive electrical circuits, a direct short may result. Damage to equipment and injury or death to personnel may occur.</p>		
Step 5.	<p>Check for 22 to 28 Vdc on wire 1461 at LHS junction box terminal 1 with ENGINE switch in the ON position.</p>	<p>If Vdc measurement is below specification, repair wire 1461 or notify DS Maintenance.</p>
Step 6.	<p>Check for continuity between wire 1435 and ground with wire 1435 (going to connector MC87) removed from terminal 3.</p>	<p>If there is no continuity, repair wire 1435 or notify DS Maintenance.</p>

Organizational Maintenance Instructions (Cont)

Table 4-3. Load Handling System (LHS) Troubleshooting (CONT)

Malfunction	Test or Inspection	Corrective Action
LOAD HANDLING SYSTEM (LHS) (CONT)		
16. LHS DOES NOT LOAD IN AUTO MODE (CONT).		
<p>The diagram illustrates the components of the Load Handling System (LHS) on a vehicle. On the left, the operator's control panel is shown with labels for the 'HYDRAULIC SELECTOR SWITCH', 'ENGINE SWITCH', and 'JOYSTICK'. On the right, the 'LHS JUNCTION BOX' is shown with a 'CONNECTOR MC87' attached. A close-up of the junction box shows seven terminals, with 'TERMINAL 4' specifically highlighted. A vehicle is shown below the junction box, with lines indicating its location on the machine.</p>		
WARNING		
<p>Remove all jewelry such as rings, dog tags, bracelets, etc. If jewelry or tools contact positive electrical circuits, a direct short may result. Damage to equipment and injury or death to personnel may occur.</p>		
Step 7.	<p>Check for 22 to 28 Vdc at LHS junction box terminal 4 with main frame down and 0 Vdc measured with main frame up.</p>	<p>If there are 22 to 28 Vdc, replace proximity switch (Para 4-37).</p>

Organizational Maintenance Instructions (Cont)

4-18. TROUBLESHOOTING INSTRUCTIONS (CONT).

Table 4-3. Load Handling System (LHS) Troubleshooting (CONT)

Malfunction	Test or Inspection	Corrective Action
LOAD HANDLING SYSTEM (LHS) (CONT)		
16. LHS DOES NOT LOAD IN AUTO MODE (CONT).		
WARNING		
<p>Remove all jewelry such as rings, dog tags, bracelets, etc. If jewelry or tools contact positive electrical circuits, a direct short may result. Damage to equipment and injury or death to personnel may occur.</p>		
<p>Step 8. Check for continuity between wire 1469 at harness connector MC81 terminal G and ground with LHS junction box terminal 4 jumpered to ground.</p>		
<p style="padding-left: 40px;">If there is no continuity, repair wire 1469 or notify DS Maintenance.</p>		

Organizational Maintenance Instructions (Cont)

Table 4-3. Load Handling System (LHS) Troubleshooting (CONT)

Malfunction	Test or Inspection	Corrective Action
LOAD HANDLING SYSTEM (LHS) (CONT)		
16. LHS DOES NOT LOAD IN AUTO MODE (CONT).		
		<ul style="list-style-type: none"> <input type="radio"/> AUTO LOAD IN <input type="radio"/> AUTO UNLOAD IN <input type="radio"/> MAN/AUTO MODE <input type="radio"/> MAN TRANSIT IN <input type="radio"/> UNLOAD OUT <input type="radio"/> LOAD OUT <input type="radio"/> AUX MODE IN <input type="radio"/> NO TRANSIT LIGHT <input type="radio"/> OVERLOAD LIGHT <input type="radio"/> HOOK ARM "A" SOL <input type="radio"/> MAIN RAM "B" SOL <input type="radio"/> HOOK ARM "B" SOL <input type="radio"/> MAIN RAM "A" SOL <input type="radio"/> +24V IN <input type="radio"/> HOOK ARM UP <input type="radio"/> FREE FLOW VALVE <input type="radio"/> HOOK ARM DOWN <input type="radio"/> TRANSIT VALVE <input type="radio"/> OVERLOAD IN
<u>WARNING</u>		
<p>Remove all jewelry such as rings, dog tags, bracelets, etc. If jewelry or tools contact positive electrical circuits, a direct short may result. Damage to equipment and injury or death to personnel may occur.</p>		
<u>CAUTION</u>		
<p>Do not allow the LHS distribution box assembly to hang from console by the wire connections to the distribution box assembly. Failure to comply will damage the wire connections.</p>		
Step 9.	<p>With engine switch ON and hydraulic selector in AUTO position, check appropriate LHS distribution box assembly indicator light for operation.</p>	
	<p style="padding-left: 40px;">If HOOK ARM "B" SOL light and MAIN RAM "B" SOL lights are not on, replace LHS distribution box assembly (Para 4-34).</p>	

Organizational Maintenance Instructions (Cont)

4-18. TROUBLESHOOTING INSTRUCTIONS (CONT).

Table 4-3. Load Handling System (LHS) Troubleshooting (CONT)

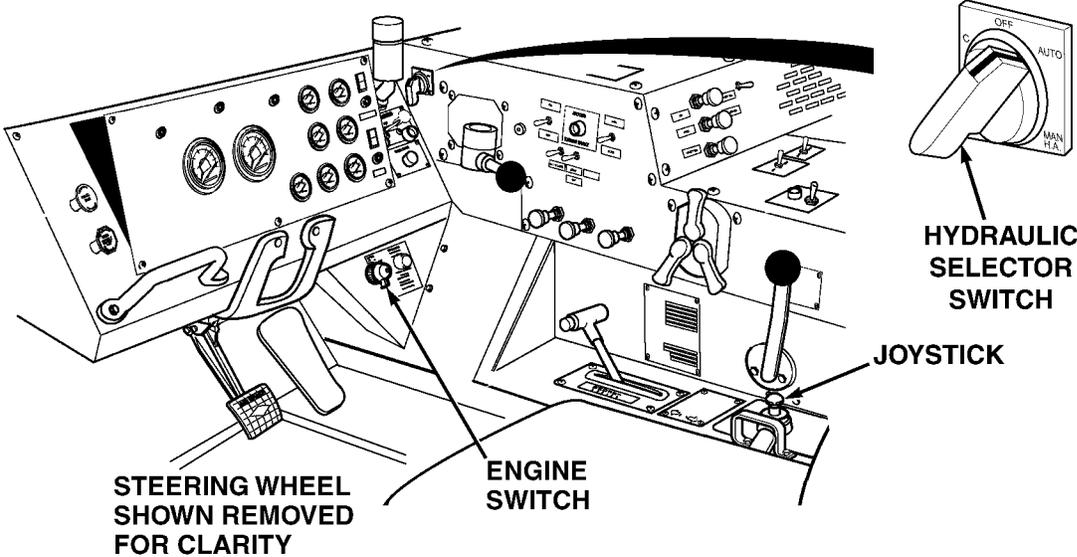
Malfunction	Test or Inspection	Corrective Action
LOAD HANDLING SYSTEM (LHS) (CONT)		
16. LHS DOES NOT LOAD IN AUTO MODE (CONT).		
		
Step 10. Check for proper operation of the LHS in AUTO mode.		
If LHS does not load, fault not corrected. Notify DS Maintenance.		

Organizational Maintenance Instructions (Cont)

Table 4-3. Load Handling System (LHS) Troubleshooting (CONT)

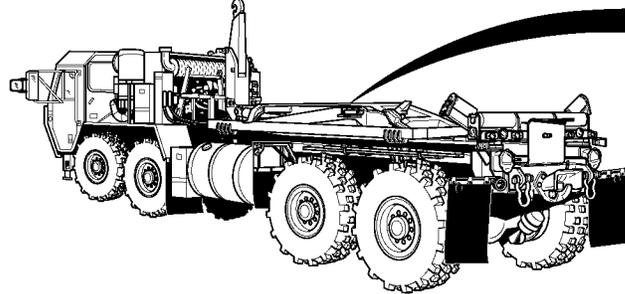
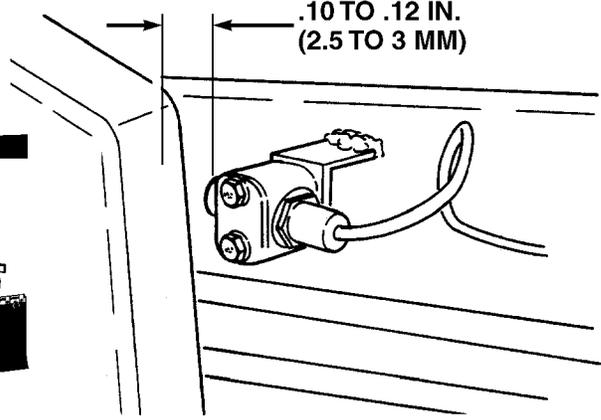
Malfunction	Test or Inspection	Corrective Action
LOAD HANDLING SYSTEM (LHS) (CONT)		
17. LHS DOES NOT UNLOAD IN AUTO MODE.		 <p style="text-align: center;">.10 TO .12 IN. (2.5 TO 3 MM)</p>
	<p>Step 1. Check clearance between proximity switch (hook arm up) and main frame .10 to .12 in. (2.5 to 3 mm) with hook arm up completely.</p> <p style="padding-left: 40px;">If clearance is more than .12 in. (3 mm) or less than .10 in. (2.5 mm), adjust proximity switch (hook arm up) (Para 4-36).</p>	

Organizational Maintenance Instructions (Cont)

4-18. TROUBLESHOOTING INSTRUCTIONS (CONT).

Table 4-3. Load Handling System (LHS) Troubleshooting (CONT)

Malfunction	Test or Inspection	Corrective Action
LOAD HANDLING SYSTEM (LHS) (CONT)		
17. LHS DOES NOT UNLOAD IN AUTO MODE (CONT).		
WARNING		
<p>Remove all jewelry such as rings, dog tags, bracelets, etc. If jewelry or tools contact positive electrical circuits, a direct short may result. Damage to equipment and injury or death to personnel may occur.</p>		
<p>Step 2. Check for continuity on wire 1485 between harness connector MC94 terminal A and harness connector MC83 terminal J.</p>		
<p style="text-align: center;">If there is no continuity, repair wire 1485 or notify DS Maintenance.</p>		

Organizational Maintenance Instructions (Cont)

Table 4-3. Load Handling System (LHS) Troubleshooting (CONT)

Malfunction	Test or Inspection	Corrective Action
LOAD HANDLING SYSTEM (LHS) (CONT)		
17. LHS DOES NOT UNLOAD IN AUTO MODE (CONT).		
<p>The diagram shows a control panel for the Load Handling System (LHS). On the left, there is a hydraulic selector switch with positions for OFF, AUTO, and MAN. A cable with a connector labeled MC94 is connected to the switch. Below the switch is a terminal block with terminals labeled A, B, C, D, E, and F. Terminal A is at the top and terminal E is at the bottom. To the right of the terminal block is the engine switch, and further right is the joystick. The diagram is used to illustrate the electrical connection for troubleshooting the LHS not unloading in AUTO mode.</p>		
WARNING		
<p>Remove all jewelry such as rings, dog tags, bracelets, etc. If jewelry or tools contact positive electrical circuits, a direct short may result. Damage to equipment and injury or death to personnel may occur.</p>		
Step 3.	<p>Check for continuity between hydraulic selector switch connector MC94 terminal A and hydraulic selector switch connector MC94 terminal E with hydraulic selector switch in AUTO position.</p>	<p>If there is no continuity, replace hydraulic selector switch (Para 4-31).</p>

Organizational Maintenance Instructions (Cont)

4-18. TROUBLESHOOTING INSTRUCTIONS (CONT).

Table 4-3. Load Handling System (LHS) Troubleshooting (CONT)

Malfunction	Test or Inspection	Corrective Action
LOAD HANDLING SYSTEM (LHS) (CONT)		
17. LHS DOES NOT UNLOAD IN AUTO MODE (CONT).		
<u>WARNING</u>		
<p>Remove all jewelry such as rings, dog tags, bracelets, etc. If jewelry or tools contact positive electrical circuits, a direct short may result. Damage to equipment and injury or death to personnel may occur.</p>		
Step 4.	<p>Check for 22 to 28 Vdc at main junction box terminal 9 with ENGINE switch in ON position.</p>	
	<p>If Vdc measurement is below specification, go to Fault 6.</p>	
	<p>If there are 22 to 28 Vdc, go to Step 5. of this Fault.</p>	

Organizational Maintenance Instructions (Cont)

Table 4-3. Load Handling System (LHS) Troubleshooting (CONT)

Malfunction	Test or Inspection	Corrective Action
LOAD HANDLING SYSTEM (LHS) (CONT)		
17. LHS DOES NOT UNLOAD IN AUTO MODE (CONT).		
WARNING		
<p>Remove all jewelry such as rings, dog tags, bracelets, etc. If jewelry or tools contact positive electrical circuits, a direct short may result. Damage to equipment and injury or death to personnel may occur.</p>		
Step 5.	<p>Check for 22 to 28 Vdc at LHS junction box terminal 1 with ENGINE switch in ON position.</p>	<p>If there are 22 to 28 Vdc, wire 1461 is OK.</p>
Step 6.	<p>Check for continuity on wire 1435 between LHS junction box terminal 2 and chassis ground, with wire 1435 (going to connector MC87) removed from terminal 2.</p>	<p>If there is no continuity, repair wire 1435 or notify DS Maintenance.</p>

Organizational Maintenance Instructions (Cont)

4-18. TROUBLESHOOTING INSTRUCTIONS (CONT).

Table 4-3. Load Handling System (LHS) Troubleshooting (CONT)

Malfunction	Test or Inspection	Corrective Action
LOAD HANDLING SYSTEM (LHS) (CONT)		
17. LHS DOES NOT UNLOAD IN AUTO MODE (CONT).		
<p>The diagram illustrates the LHS junction box and terminal strip. A terminal strip with terminals numbered 1 through 7 is shown. Terminal 5 is specifically labeled. Below it, the LHS junction box is shown with a connector MC87. A truck is shown with the junction box mounted on its side.</p>		
<u>WARNING</u>		
<p>Remove all jewelry such as rings, dog tags, bracelets, etc. If jewelry or tools contact positive electrical circuits, a direct short may result. Damage to equipment and injury or death to personnel may occur.</p>		
<p>Step 7. Check for 22 to 28 Vdc at LHS junction box terminal 5 with hook arm up.</p>		
<p style="padding-left: 40px;">If there is not 22 to 28 Vdc present, replace proximity switch (hook arm up) (Para 4-36).</p>		

Organizational Maintenance Instructions (Cont)

Table 4-3. Load Handling System (LHS) Troubleshooting (CONT)

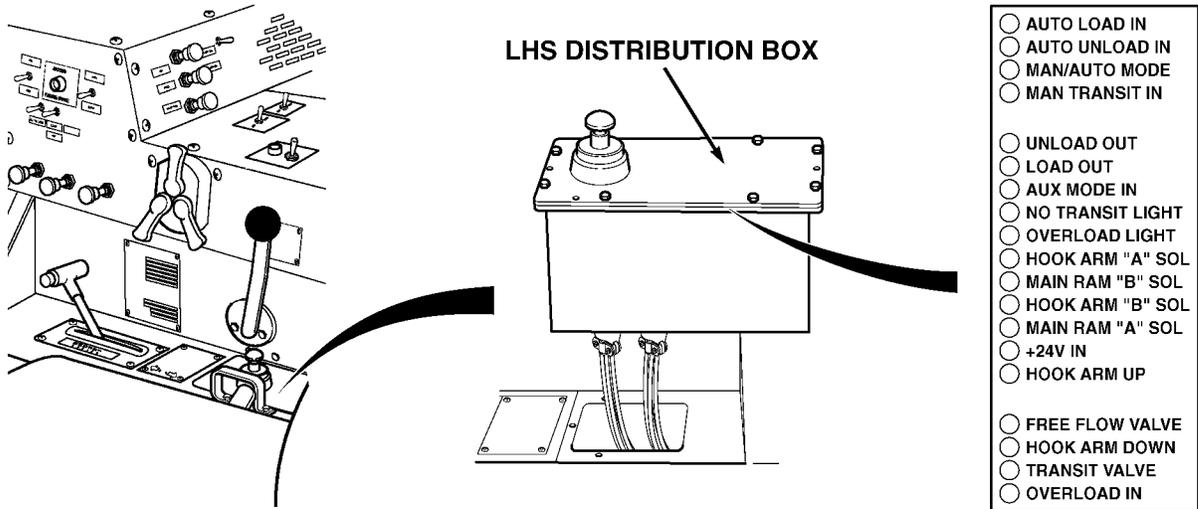
Malfunction	Test or Inspection	Corrective Action
LOAD HANDLING SYSTEM (LHS) (CONT)		
17. LHS DOES NOT UNLOAD IN AUTO MODE (CONT).		
<p>Step 8. Check continuity on wire 1466 between harness connector MC81 terminal E and ground with LHS junction box terminal 5 jumpered to ground.</p>		
<p>It there is no continuity, repair wire 1466 or notify DS Maintenance.</p>		
<div style="display: flex; align-items: center;">  </div>		
<u>WARNING</u>		
<p>Remove all jewelry such as rings, dog tags, bracelets, etc. If jewelry or tools contact positive electrical circuits, a direct short may result. Damage to equipment and injury or death to personnel may occur.</p>		
<u>CAUTION</u>		
<p>Do not allow the LHS distribution box assembly to hang from console by the wire connections to the distribution box assembly. Failure to comply will damage the wire connections.</p>		
<p>Step 9. With engine switch ON, hydraulic selector switch in AUTO position, and joystick in unload position, check for appropriate distribution box indicator light operation.</p>		
<p>If HOOK ARM "A" SOL light and MAIN RAM "A" SOL light are not on, replace LHS distribution box assembly (Para 4-34).</p>		

Organizational Maintenance Instructions (Cont)

4-18. TROUBLESHOOTING INSTRUCTIONS (CONT).

Table 4-3. Load Handling System (LHS) Troubleshooting (CONT)

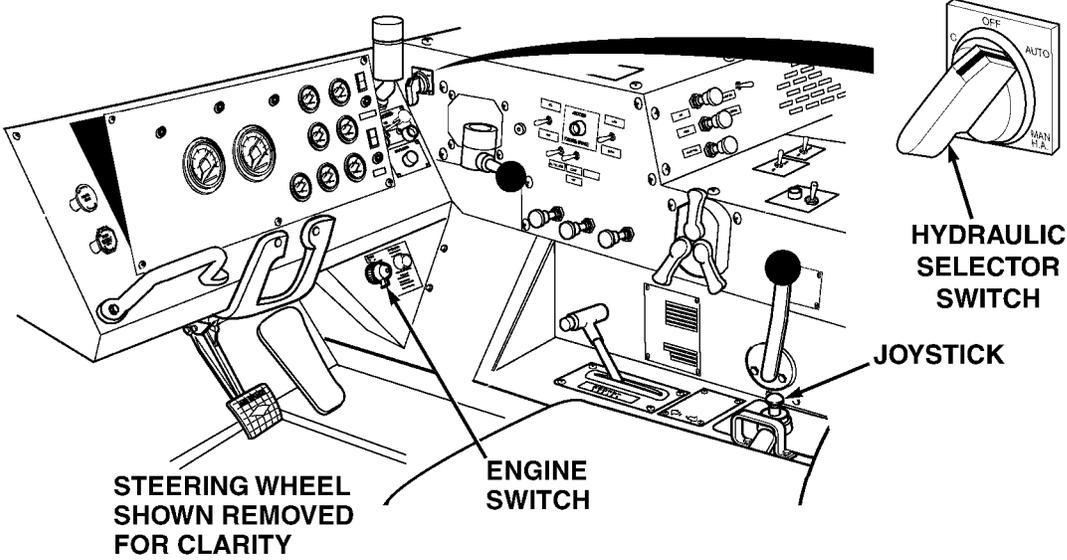
Malfunction	Test or Inspection	Corrective Action
LOAD HANDLING SYSTEM (LHS) (CONT)		
17. LHS DOES NOT UNLOAD IN AUTO MODE (CONT).		
		
<p>Step 10. Operate LHS in AUTO mode.</p> <p>If LHS does not unload, fault not corrected. Notify DS Maintenance.</p>		

Organizational Maintenance Instructions (Cont)

Table 4-3.1. Container Handling Unit (CHU) Troubleshooting

Malfunction	Test or Inspection	Corrective Action
CONTAINER HANDLING UNIT (CHU)		
1. MAIN FRAME DOES NOT UNLOAD.		
<p>Step 1. Disconnect the jumper harness at connector MC82 at the LHS control box. Disconnect connector MC82B at the CHU control box and connect to LHS control box. Does LHS function correctly when CHU control box is bypassed?</p>		
<p style="padding-left: 40px;">If LHS functions correctly, reconnect CHU control box and go to Fault 2.</p>		
<p style="padding-left: 40px;">If main frame does not unload properly, fault is within LHS system. Refer to LHS Troubleshooting table (Table 4-2).</p>		

Organizational Maintenance Instructions (Cont)

4-18. TROUBLESHOOTING INSTRUCTIONS (CONT).

Table 4-3.1. Container Handling Unit (CHU) Troubleshooting (CONT)

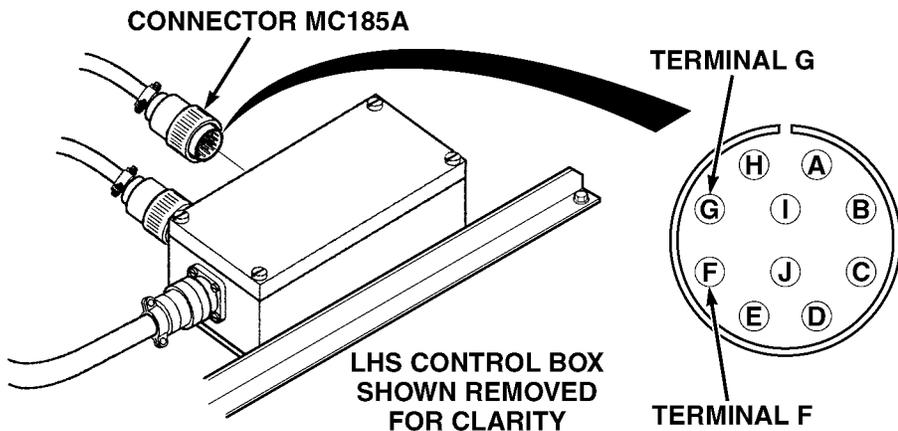
Malfunction	Test or Inspection	Corrective Action
CONTAINER HANDLING UNIT (CHU) (CONT)		
2. LHS-CHU DOES NOT UNLOAD.	 <p style="text-align: center;">CONNECTOR MC185A</p> <p style="text-align: center;">TERMINAL G</p> <p style="text-align: center;">TERMINAL F</p> <p style="text-align: center;">LHS CONTROL BOX SHOWN REMOVED FOR CLARITY</p>	
<u>WARNING</u>		
<p>Remove all jewelry such as rings, dog tags, bracelets, etc. If jewelry or tools contact positive electrical circuits, a direct short may result. Damage to equipment and injury or death to personnel may occur.</p>		
Step 1.	<p>Check for continuity between connector MC185A, terminal F and terminal G.</p> <p style="padding-left: 40px;">If there is continuity between connector MC185, terminal F and terminal G, replace CHU wiring harness.</p>	

Organizational Maintenance Instructions (Cont)

Table 4-3.1. Container Handling Unit (CHU) Troubleshooting (CONT)

Malfunction	Test or Inspection	Corrective Action
CONTAINER HANDLING UNIT (CHU)		
2. LHS-CHU DOES NOT UNLOAD (CONT).		
WARNING		
<p>Remove all jewelry such as rings, dog tags, bracelets, etc. If jewelry or tools contact positive electrical circuits, a direct short may result. Damage to equipment and injury or death to personnel may occur.</p>		
Step 2.	<p>Remove relay R52 and check for continuity between wire 1464 at relay R52 socket, terminal 3 and connector MC82A, terminal D.</p>	
<p>If there is no continuity, replace CHU control box wiring (Para 4-34.2).</p>		

Organizational Maintenance Instructions (Cont)

4-18. TROUBLESHOOTING INSTRUCTIONS (CONT).

Table 4-3.1. Container Handling Unit (CHU) Troubleshooting (CONT)

Malfunction

Test or Inspection

Corrective Action

CONTAINER HANDLING UNIT (CHU) (CONT)

2. LHS-CHU DOES NOT UNLOAD (CONT).

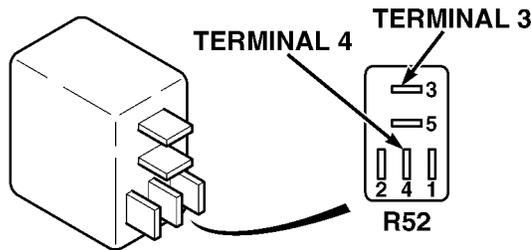

WARNING

Remove all jewelry such as rings, dog tags, bracelets, etc. If jewelry or tools contact positive electrical circuits, a direct short may result. Damage to equipment and injury or death to personnel may occur.

- Step 3. Check for continuity between relay R52, terminal 3 and terminal 4.
If there is no continuity, replace relay R52.

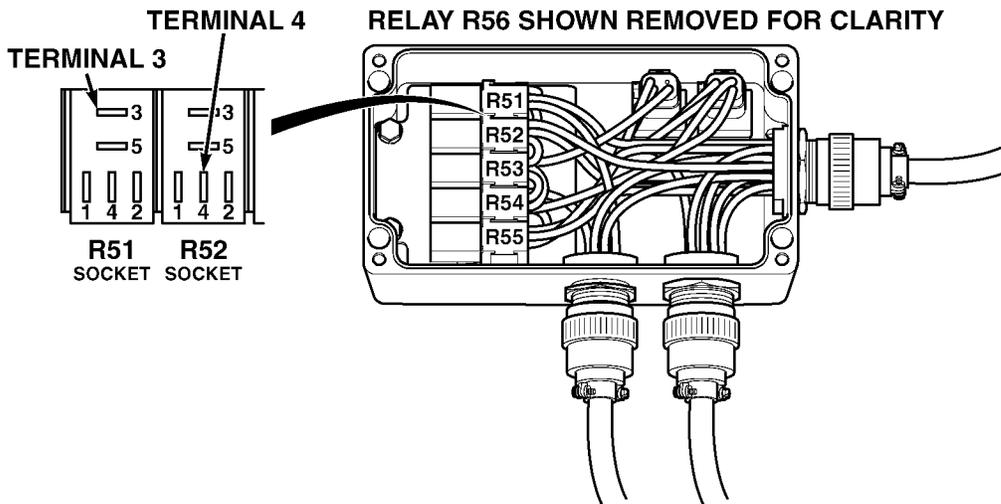

WARNING

Remove all jewelry such as rings, dog tags, bracelets, etc. If jewelry or tools contact positive electrical circuits, a direct short may result. Damage to equipment and injury or death to personnel may occur.

- Step 4. Remove relay R51 and check for continuity between wire 1464A at relay R52, terminal 4 and relay R51, terminal 3.
If there is no continuity, replace wire.

Organizational Maintenance Instructions (Cont)

Table 4-3.1. Container Handling Unit (CHU) Troubleshooting (CONT)

Malfunction
Test or Inspection

Corrective Action

CONTAINER HANDLING UNIT (CHU) (CONT)

2. LHS-CHU DOES NOT UNLOAD (CONT).

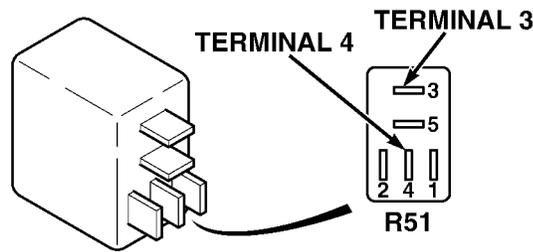

WARNING

Remove all jewelry such as rings, dog tags, bracelets, etc. If jewelry or tools contact positive electrical circuits, a direct short may result. Damage to equipment and injury or death to personnel may occur.

Step 5. Check for continuity between relay R51, terminal 3 and terminal 4.

If there is no continuity, replace relay R51.

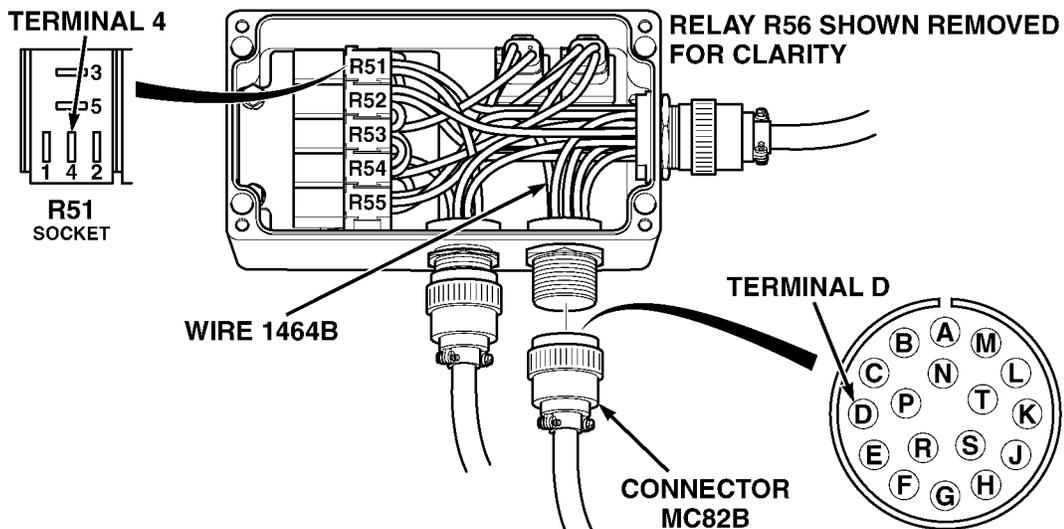

WARNING

Remove all jewelry such as rings, dog tags, bracelets, etc. If jewelry or tools contact positive electrical circuits, a direct short may result. Damage to equipment and injury or death to personnel may occur.

Step 6. Check for continuity between wire 1464B at connector MC82B, terminal D and relay R51, terminal 4.

If there is no continuity, replace CHU control box wiring (Para 4-34.2).

Organizational Maintenance Instructions (Cont)

4-18. TROUBLESHOOTING INSTRUCTIONS (CONT).

Table 4-3.1. Container Handling Unit (CHU) Troubleshooting (CONT)

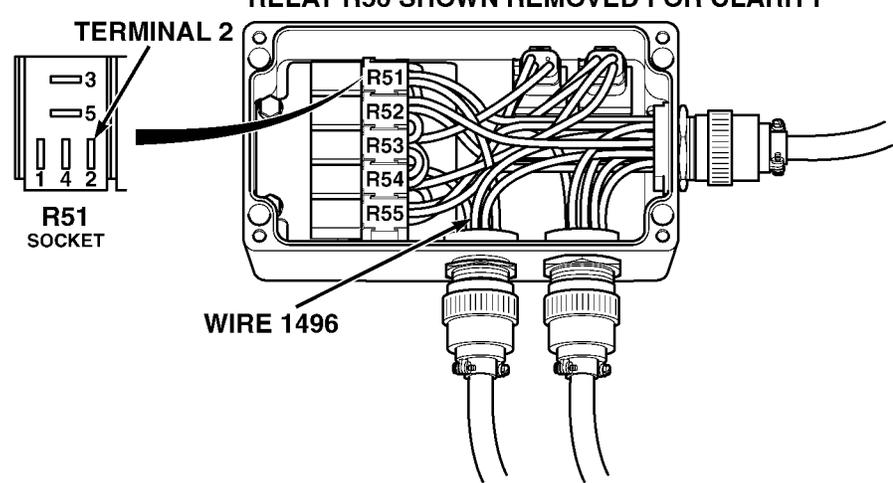
Malfunction Test or Inspection	Corrective Action
CONTAINER HANDLING UNIT (CHU) (CONT)	
2. LHS-CHU DOES NOT UNLOAD (CONT).	
<div style="text-align: center;"> <p>RELAY R56 SHOWN REMOVED FOR CLARITY</p>  </div>	
<u>WARNING</u>	
<p>Remove all jewelry such as rings, dog tags, bracelets, etc. If jewelry or tools contact positive electrical circuits, a direct short may result. Damage to equipment and injury or death to personnel may occur.</p>	
<p>Step 7. Check for continuity between relay R51, terminal 2 and a known good ground.</p> <p style="padding-left: 40px;">If there is no continuity, fault not fixed. Notify DS Maintenance.</p> <p style="padding-left: 40px;">If there is continuity, repair wire 1496 to connector MC190.</p>	

Organizational Maintenance Instructions (Cont)

Table 4-3.1. Container Handling Unit (CHU) Troubleshooting (CONT)

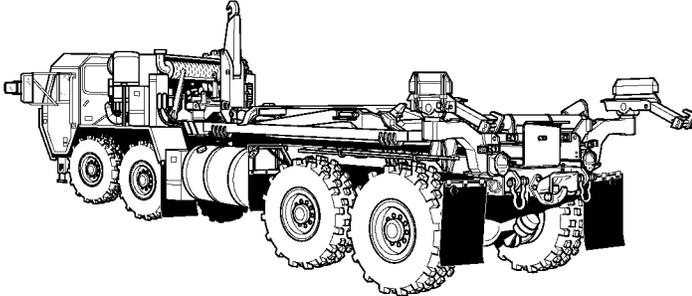
Malfunction	Test or Inspection	Corrective Action
CONTAINER HANDLING UNIT (CHU)		
2. LHS-CHU DOES NOT UNLOAD (CONT).		
		
Step 8.	Does LHS-CHU operate properly?	<p>No, fault not fixed. Notify DS Maintenance.</p> <p>Yes, fault corrected.</p>

Organizational Maintenance Instructions (Cont)

4-18. TROUBLESHOOTING INSTRUCTIONS (CONT).

Table 4-3.1. Container Handling Unit (CHU) Troubleshooting (CONT)

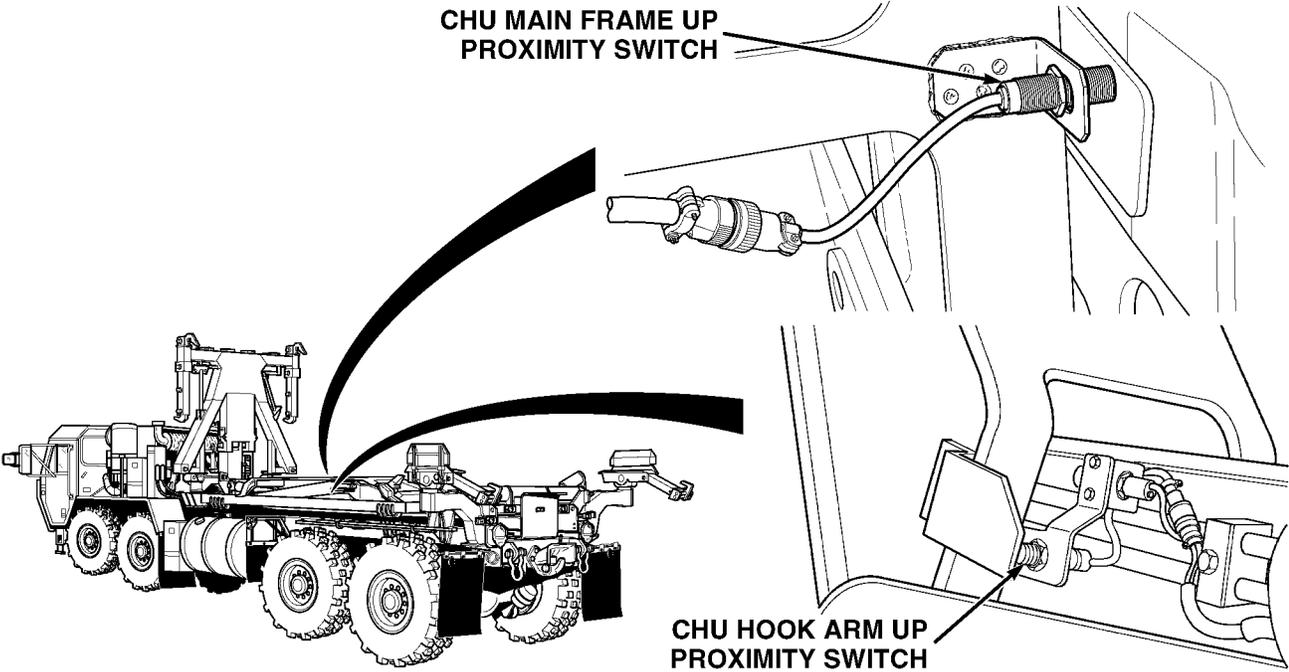
Malfunction	Test or Inspection	Corrective Action
CONTAINER HANDLING UNIT (CHU) (CONT)		
3. HOOK ARM EXTENDS TOO FAR.	 <p>CHU MAIN FRAME UP PROXIMITY SWITCH</p> <p>CHU HOOK ARM UP PROXIMITY SWITCH</p>	<p>Step 1. Check adjustment of CHU hook arm up proximity switch. Adjust CHU hook arm up proximity switch as necessary (Para 4-36).</p> <p>Step 2. Check adjustment of CHU main frame up proximity switch. Adjust CHU main frame up proximity as necessary (Para 4-37.2).</p>

Organizational Maintenance Instructions (Cont)

Table 4-3.1. Container Handling Unit (CHU) Troubleshooting (CONT)

Malfunction	Test or Inspection	Corrective Action
CONTAINER HANDLING UNIT (CHU) (CONT)		
3. HOOK ARM EXTENDS TOO FAR (CONT).		
WARNING		
<p>Remove all jewelry such as rings, dog tags, bracelets, etc. If jewelry or tools contact positive electrical circuits, a direct short may result. Damage to equipment and injury or death to personnel may occur.</p>		
Step 3.	<p>Remove relay R53 and check for 22 to 28 Vdc measured on wire 1466B at relay R53, terminal 3.</p>	
	<p style="padding-left: 40px;">If there are 22 to 28 Vdc, go to Step 6 of this Fault.</p>	
	<p style="padding-left: 40px;">If there are not 22 to 28 Vdc, go to Step 4 of this Fault.</p>	

Organizational Maintenance Instructions (Cont)

4-18. TROUBLESHOOTING INSTRUCTIONS (CONT).

Table 4-3.1. Container Handling Unit (CHU) Troubleshooting (CONT)

Malfunction	Test or Inspection	Corrective Action
-------------	--------------------	-------------------

CONTAINER HANDLING UNIT (CHU) (CONT)

3. HOOK ARM EXTENDS TOO FAR (CONT).

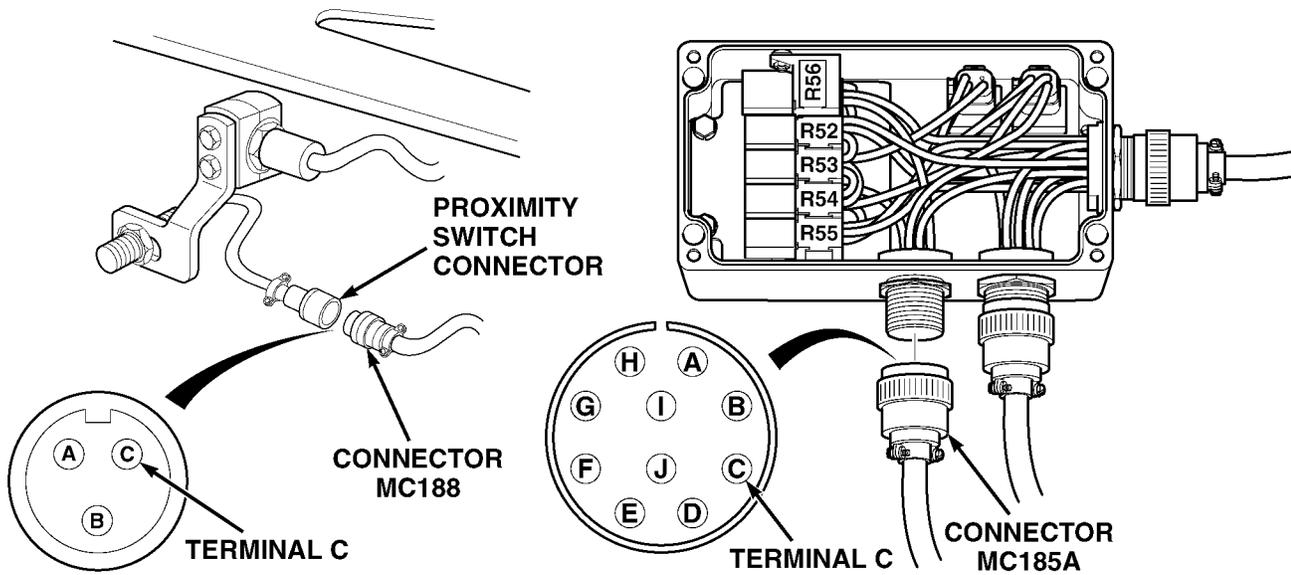

Step 4. Check for continuity between connector MC185A, terminal C and connector MC188, terminal C.

If there is no continuity, repair wire 1466B between connector MC185A and connector MC188.

Organizational Maintenance Instructions (Cont)

Table 4-3.1. Container Handling Unit (CHU) Troubleshooting (CONT)

Malfunction	Test or Inspection	Corrective Action
CONTAINER HANDLING UNIT (CHU) (CONT)		
3. HOOK ARM EXTENDS TOO FAR (CONT).		
<u>WARNING</u>		
<p>Remove all jewelry such as rings, dog tags, bracelets, etc. If jewelry or tools contact positive electrical circuits, a direct short may result. Damage to equipment and injury or death to personnel may occur.</p>		
Step 5.	Check for continuity between connector MC185A, terminal C and relay R53, terminal 3.	
	If there is no continuity, repair or replace CHU control box (Para 4-34.1).	
	If there is continuity, replace CHU hook arm up proximity switch (Para 4-36).	

Organizational Maintenance Instructions (Cont)

4-18. TROUBLESHOOTING INSTRUCTIONS (CONT).

Table 4-3.1. Container Handling Unit (CHU) Troubleshooting (CONT)

Malfunction	Test or Inspection	Corrective Action
CONTAINER HANDLING UNIT (CHU) (CONT)		
3. HOOK ARM EXTENDS TOO FAR (CONT).		
<p>The diagram shows a cross-section of the CHU control box. On the left is an R55 socket with terminals 1, 2, 3, 4, and 5. Terminal 2 is connected to relay R55. Inside the box are relays R52, R53, R54, and R55. A circular connector MC185A is at the bottom with terminals A through J. Terminal F is connected to wire 1495, which also connects to terminal 2 of the R55 socket. Other wires connect the relays to the connector.</p>		
WARNING		
<p>Remove all jewelry such as rings, dog tags, bracelets, etc. If jewelry or tools contact positive electrical circuits, a direct short may result. Damage to equipment and injury or death to personnel may occur.</p>		
Step 6.	<p>Remove relay T55 and check for continuity between wire 1495 at connector MC185A, terminal F and relay R55, terminal 2.</p>	
<p>If there is no continuity, replace CHU control box wiring (Para 4-34.2).</p>		

Organizational Maintenance Instructions (Cont)

Table 4-3.1. Container Handling Unit (CHU) Troubleshooting (CONT)

Malfunction	Test or Inspection	Corrective Action
CONTAINER HANDLING UNIT (CHU) (CONT)		
3. HOOK ARM EXTENDS TOO FAR (CONT).		
<u>WARNING</u>		
<p>Remove all jewelry such as rings, dog tags, bracelets, etc. If jewelry or tools contact positive electrical circuits, a direct short may result. Damage to equipment and injury or death to personnel may occur.</p>		
Step 7.	<p>Remove relay R54 and check for continuity between wire 1435 at relay R55, terminal 2 and relay R54, terminal 2.</p>	
<p>If there is no continuity, repair wire 1435.</p>		

Organizational Maintenance Instructions (Cont)

4-18. TROUBLESHOOTING INSTRUCTIONS (CONT).

Table 4-3.1. Container Handling Unit (CHU) Troubleshooting (CONT)

Malfunction	Test or Inspection	Corrective Action
-------------	--------------------	-------------------

CONTAINER HANDLING UNIT (CHU) (CONT)

3. HOOK ARM EXTENDS TOO FAR (CONT).

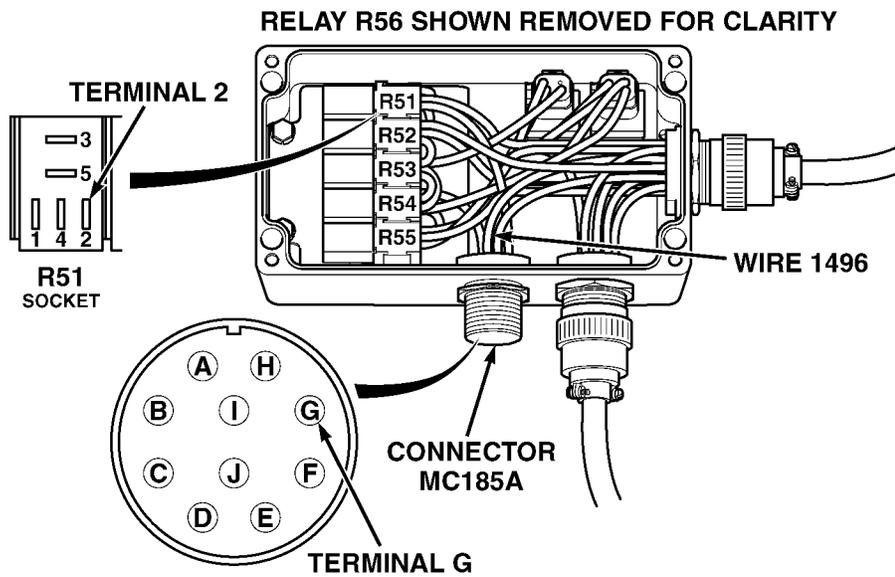

WARNING

Remove all jewelry such as rings, dog tags, bracelets, etc. If jewelry or tools contact positive electrical circuits, a direct short may result. Damage to equipment and injury or death to personnel may occur.

Step 8. Remove relay R51 and check for continuity between wire 1496 at relay R51, terminal 2 and connector MC185A, terminal G.

If there is no continuity, repair wire 1496.

Organizational Maintenance Instructions (Cont)

Table 4-3.1. Container Handling Unit (CHU) Troubleshooting (CONT)

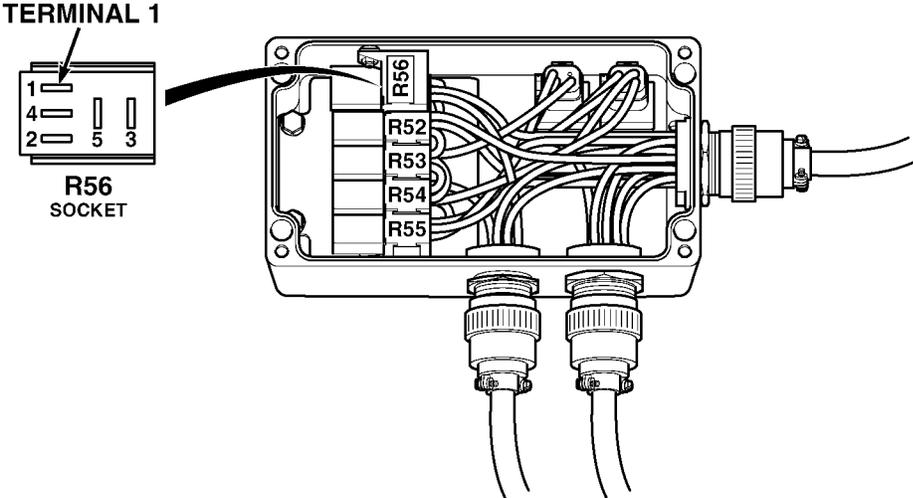
Malfunction	Test or Inspection	Corrective Action
CONTAINER HANDLING UNIT (CHU) (CONT)		
4. MAIN FRAME DOES NOT GO TO TRAVEL POSITION.		
		
<u>WARNING</u>		
<p>Remove all jewelry such as rings, dog tags, bracelets, etc. If jewelry or tools contact positive electrical circuits, a direct short may result. Damage to equipment and injury or death to personnel may occur.</p>		
Step 1.	<p>Remove relay R56 and check for 22 to 28 Vdc measured on wire 1469E at relay R56, terminal 1.</p>	<p>If there are 22 to 28 Vdc, go to Step 4 of this Fault. If there are not 22 to 28 Vdc, go to Step 2 of this Fault.</p>

Organizational Maintenance Instructions (Cont)

4-18. TROUBLESHOOTING INSTRUCTIONS (CONT).

Table 4-3.1. Container Handling Unit (CHU) Troubleshooting (CONT)

Malfunction

Test or Inspection

Corrective Action

CONTAINER HANDLING UNIT (CHU) (CONT)

4. MAIN FRAME DOES NOT GO TO TRAVEL POSITION (CONT).

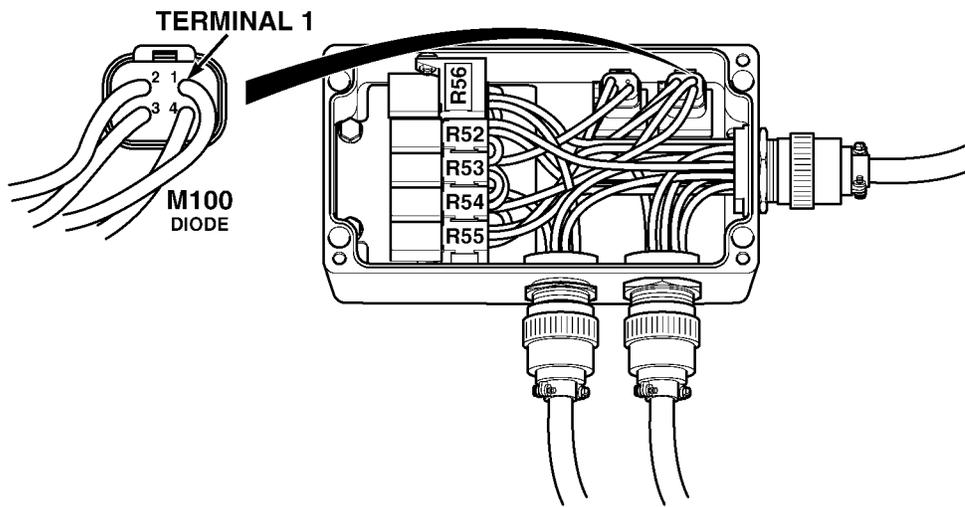

WARNING

Remove all jewelry such as rings, dog tags, bracelets, etc. If jewelry or tools contact positive electrical circuits, a direct short may result. Damage to equipment and injury or death to personnel may occur.

Step 2. Check for 22 to 28 Vdc measured on wire 1469E at diode M100, terminal 1.

If there are 22 to 28 Vdc, repair wire 1469E.

If there are not 22 to 28 Vdc, go to Step 3 of this Fault.

Organizational Maintenance Instructions (Cont)

Table 4-3.1. Container Handling Unit (CHU) Troubleshooting (CONT)

Malfunction	Test or Inspection	Corrective Action
CONTAINER HANDLING UNIT (CHU) (CONT)		
4. MAIN FRAME DOES NOT GO TO TRAVEL POSITION (CONT).		
WARNING		
<p>Remove all jewelry such as rings, dog tags, bracelets, etc. If jewelry or tools contact positive electrical circuits, a direct short may result. Damage to equipment and injury or death to personnel may occur.</p>		
Step 3.	Check for 22 to 28 Vdc measured at diode M100, terminal 2, wire 1469B.	
	If there are 22 to 28 Vdc, replace diode M100.	
	If there are not 22 to 28 Vdc, refer to Fault 3, Hook Arm Extends Too Far Step 5.	

Organizational Maintenance Instructions (Cont)

4-18. TROUBLESHOOTING INSTRUCTIONS (CONT).

Table 4-3.1. Container Handling Unit (CHU) Troubleshooting (CONT)

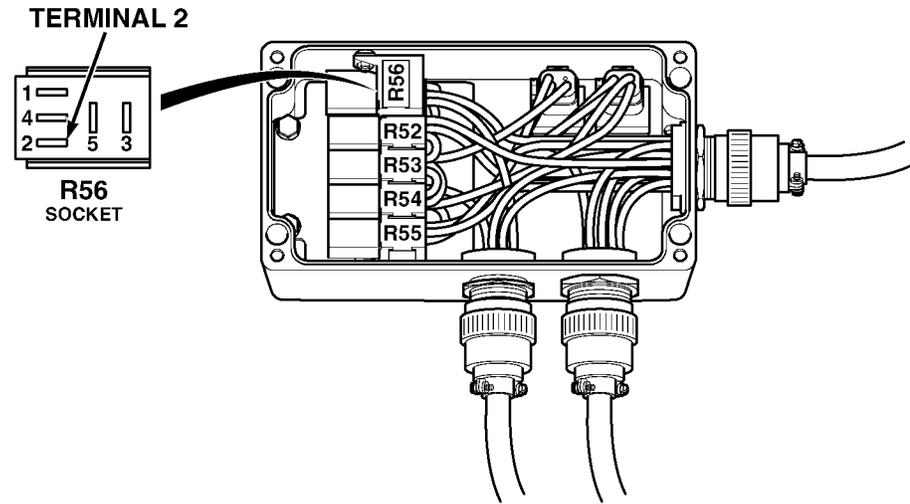
Malfunction Test or Inspection	Corrective Action
CONTAINER HANDLING UNIT (CHU) (CONT)	
4. MAIN FRAME DOES NOT GO TO TRAVEL POSITION (CONT).	
	
WARNING	
<p>Remove all jewelry such as rings, dog tags, bracelets, etc. If jewelry or tools contact positive electrical circuits, a direct short may result. Damage to equipment and injury or death to personnel may occur.</p>	
<p>Step 4. Remove relay R56 and check for continuity between relay 56, terminal 2 and a known good ground.</p>	<p>If there is no continuity, Fault not fixed. Repair wire 1435.</p> <p>If there is continuity, replace relay R56.</p>

Organizational Maintenance Instructions (Cont)

Table 4-3.1. Container Handling Unit (CHU) Troubleshooting (CONT)

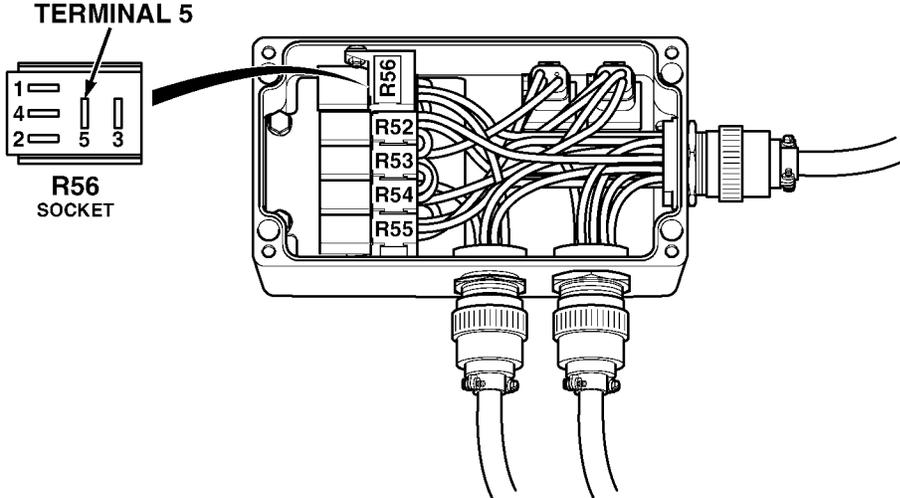
Malfunction	Test or Inspection	Corrective Action
CONTAINER HANDLING UNIT (CHU) (CONT)		
4. MAIN FRAME DOES NOT GO TO TRAVEL POSITION (CONT).		
		
<u>WARNING</u>		
<p>Remove all jewelry such as rings, dog tags, bracelets, etc. If jewelry or tools contact positive electrical circuits, a direct short may result. Damage to equipment and injury or death to personnel may occur.</p>		
Step 5.	<p>Remove relay R56 and check for continuity between relay R56, terminal 5 and a good ground.</p>	
	<p>If there is no continuity, Fault not fixed. Replace wire 1467A.</p>	
	<p>If there is continuity, replace relay R56.</p>	

Organizational Maintenance Instructions (Cont)

4-18. TROUBLESHOOTING INSTRUCTIONS (CONT).

Table 4-3.1. Container Handling Unit (CHU) Troubleshooting (CONT)

Malfunction	Test or Inspection	Corrective Action
CONTAINER HANDLING UNIT (CHU) (CONT)		
4. MAIN FRAME DOES NOT GO TO TRAVEL POSITION (CONT).		
<p style="text-align: center;">WARNING</p> <p>Remove all jewelry such as rings, dog tags, bracelets, etc. If jewelry or tools contact positive electrical circuits, a direct short may result. Damage to equipment and injury or death to personnel may occur.</p>		
Step 6.	Remove relay R56 and check for continuity between wire 1467 at relay R56, terminal 3 and connector MC82B, terminal B.	If there is no continuity, repair wire 1467.

Organizational Maintenance Instructions (Cont)

Section VI. Maintenance Procedures

4-19. MAINTENANCE INTRODUCTION.

This chapter provides maintenance instructions for repairing, replacing, installing, and servicing the Load Handling System (LHS) components as authorized by the Maintenance Allocation Chart (MAC) at the Organizational Maintenance level.

4-20. GENERAL REMOVAL INSTRUCTIONS.

a. Work Required. Remove parts if repair or replacement is required. Do not disassemble a component any further than needed.

b. Preparation. Before removal of any electrical, hydraulic, or air system components ensure system component is not energized or pressurized. Disconnect battery ground cables. Relieve air system pressure. Before removal of fasteners (nuts, locknuts). Remove any paint on threads to prevent binding of fasteners.

c. Identification. To ease assembly and installation, tag and mark shims, connectors, wires, and mating ends of lines before disconnecting them. Identify similar parts to ensure correct assembly.

d. Position of Valves. Before removing valve handles, mark or diagram their positions when open and closed. This will help during assembly.

e. Location. Before removing cable ties, cushion clamps, hoses, tubing, wiring, etc., note the location, position, and routing to ensure correct assembly.

4-21. GENERAL DISASSEMBLY INSTRUCTIONS.

a. Cleanliness. Work area must be as clean as possible to prevent contamination of components.

CAUTION

Self-locking fasteners that are loosened must be replaced, not tightened.

b. Locking Parts. Replace all lockwire, lockwashers, cotter pins, and locknuts at time of reassembly.

c. Expendable Parts. All gaskets, packings, and seals removed during repair must be discarded and replaced with new parts.

d. Removing Seals. Be sure all traces of oil, gaskets, and sealants are removed from components. When possible, use wood or plastic probes and scrapers to prevent damage to machined surfaces.

e. Parts Protection. To keep dust, dirt, moisture, and other objects out of internal parts of systems or components, cap or tape over all open tubes, hoses, air lines, fittings, and component openings as soon as parts are removed. Wrap all removed parts in clean paper or dip parts in preservation oil.

Organizational Maintenance Instructions (Cont)

4-22. GENERAL CLEANING INSTRUCTIONS.**WARNING**

- Drycleaning solvent (P-D-680) is TOXIC and flammable. Wear protective goggles, face shield, and gloves; use only in a well-ventilated area; avoid contact with skin, eyes, and clothes; and do not breathe vapors. Keep away from heat or flame. Never smoke when using solvent. The flashpoint for Type III Drycleaning Solvent is 200°F (93°C). Failure to do so may result in injury or death to personnel.
- If personnel become dizzy while using cleaning solvent, immediately get fresh air and medical help. If solvent contacts skin or clothes, flush with cold water. If solvent contacts eyes, immediately flush eyes with water, and get immediate medical attention.
- Never use fuel to clean parts. Fuel is highly flammable. Serious personal injury could result if fuel ignites during cleaning.
- Compressed air used for cleaning purposes will not exceed 30 psi (207 kPa). Use only with effective chip guarding and personal protective equipment (goggles/shield, gloves, etc). Failure to comply may result in injury to personnel.

a. Cleaning Solvents. Use only approved cleaning solvents to clean parts. Drycleaning solvent P-D-680 (Item 18, Appendix F) is commonly used. Always work in a well-ventilated area.

b. Removing Deposits. Soak parts in drycleaning solvent (Item 18, Appendix F), and wash away deposits by flushing or spraying. When necessary, brush with a soft bristle brush (not wire) moistened in solvent. Use compressed air to dry parts (except bearings) after cleaning. Bearings must drip and air dry.

c. Tools. Do not use wire brushes, abrasive wheels, or abrasive compounds to clean parts unless specifically approved in the detailed procedures. Parts may be scratched or altered and a highly stressed part may weaken.

d. Ball and Roller Bearings. When cleaning ball or roller bearings, place them in a basket and suspend them in a container of drycleaning solvent (Item 18, Appendix F). If needed, use a brush to remove caked grease, chips, etc. Avoid rotating bearing before solid particles are removed to prevent damaging races and balls. When bearings have been cleaned, coat them lightly with lubricating oil (Item 10, Appendix F) to remove solvent.

CAUTION

Do not clean tires, lubricant seals, rubber hoses, or electrical components with solvent.

e. Rubber Parts. Do not clean preformed packings or rubber parts in drycleaning solvent. Wipe parts clean with a dry, cleaning cloth (Item 5, Appendix F).

WARNING

Steam cleaning creates hazardous noise levels and severe burn potential. Eye, skin, and ear protection is required. Failure to comply may result in injury to personnel.

f. Exterior Parts. Steam clean all exterior parts thoroughly before removing. This will make inspection and disassembly easier.

Organizational Maintenance Instructions (Cont)

WARNING

Solvents used with a spray gun must be used in a spray booth with a filter. Face shield must be used by personnel operating spray gun. Failure to comply may result in injury to personnel.

g. LHS Assembly. Use a spray gun and solvent mixture for cleaning exterior of LHS assembly. Allow mixture to remain on item surface for 10 minutes before rinsing. Rinse with hot water under 80 to 120 pounds of pressure, if available. An ordinary garden hose with nozzle may be used if other equipment is not available. Rinse thoroughly.

CAUTION

To prevent corrosion, parts should be dipped in rust preventive within two hours of degreasing.

h. Degreasing Machine. A degreasing machine may be used to remove heavy grease and oil from metal parts.

WARNING

- Drycleaning solvent (P-D-680) is TOXIC and flammable. Wear protective goggles, face shield, and gloves; use only in a well-ventilated area; avoid contact with skin, eyes, and clothes; and do not breathe vapors. Keep away from heat or flame. Never smoke when using solvent. The flashpoint for Type III Drycleaning Solvent is 200°F (93°C). Failure to do so may result in injury or death to personnel.
- If personnel become dizzy while using cleaning solvent, immediately get fresh air and medical help. If solvent contacts skin or clothes, flush with cold water. If solvent contacts eyes, immediately flush eyes with water and get immediate medical attention.
- Never use fuel to clean parts. Fuel is highly flammable. Serious personal injury could result if fuel ignites during cleaning.

i. Passages. After degreasing, check all oil passages and cavities for dirt or blockage before coating with lubricating oil (Item 10, Appendix F). Run a thin, flexible wire through oil passages to make sure they are not clogged. Use a pressure spray gun and drycleaning solvent (Item 18, Appendix F) to clean dirty passages.

j. Electrical Parts. Electrical parts; such as coils, junction blocks, and switches, should not be soaked or sprayed with cleaning solutions. Clean these parts with a cleaning cloth (Item 5, Appendix F) moistened with drycleaning solvent (Item 18, Appendix F).

k. Hydraulic System. When cleaning hydraulic system parts use drycleaning solvent P-D-680. Clean and dry parts thoroughly to make sure no residue remains. If a coating preservative is required before assembly, apply a light film of lubricating oil (Item 10, Appendix F). If petroleum-free solvents are not available, use the same hydraulic fluid as used in the truck's system.

Organizational Maintenance Instructions (Cont)

4-23. GENERAL INSPECTION INSTRUCTIONS.

a. Cleaning. Clean all parts before inspection. Check for defects such as physical distortion, wear, cracks, and pitting.

b. Sealing Surfaces. Inspect all surfaces in contact with gaskets, packings, or seals for nicks and burrs. If any defect is found, remove it before assembly.

c. Tubing, Hoses, and Fittings. Inspect all hose surfaces for broken or frayed fabric. Check for breaks caused by sharp kinks or contact with other parts of the truck. Inspect fittings, tubing, mating surfaces, and threads for nicks, cracks, scratches, and other damage. Replace any defective part. After assembly and during initial truck operation periods, check for leaks.

d. Electrical Parts. Inspect all wiring harnesses for broken, chafed, or burned wiring. Inspect all terminal connectors for loose connections and broken parts.

e. Metal Parts. Visually inspect all castings and weldments for cracks. Parts that carry a great load should receive magnetic particle inspection. Critical non-ferrous parts may be inspected with fluorescent penetrant.

4-24. GENERAL REPAIR INSTRUCTIONS.

a. Exterior Parts. Chassis and exterior painted parts may be resurfaced when paint is damaged or where parts have been repaired.

NOTE

Polished or machined steel parts not protected by cadmium, tin, copper, or other plating or surface treatments require protection. Bare metal surfaces must be free of moisture when protective coating is applied.

b. Protecting Parts. Protect bare steel surfaces from rust when not actually undergoing repair work. Dip parts in, or spray them with, corrosion preventive compound (Item 7, Appendix F). Aluminum parts may require protection in atmospheres having a high salt content.

c. Screws, Nuts, and Fittings. Replace any screw, nut, or fitting with damaged threads. Inspect tapped holes for thread damage. If cross-threading is evident, retap the hole for the next oversize screw or stud. If the retapping will weaken the part, or if the cost of the part makes retapping impractical, replace the part. Chasing the threads with a properly size tap or die may be adequate.

d. Stud Installation. Use a proper driver when installing studs. A worn stud driver may damage the end thread. Then a chasing die must be used before a nut can be screwed on. This procedure will remove cadmium plating and allow corrosion. Before installing a stud, inspect the hole for chips. Blow out foreign matter and start stud by hand. Before final insertion, coat thread with a film of antiseize compound (Item 6, Appendix F). Install stud to proper "setting height", which is the total projecting length.

e. Dents. Straighten minor body dents by bumping with a soft-faced hammer while using a wooden block backing.

f. Sheet Metal Repair. Repair minor skin cracks by installing patches.

Organizational Maintenance Instructions (Cont)

4-25. GENERAL ASSEMBLY INSTRUCTIONS.

a. Preparation. Remove protective grease coatings from new parts before installation.

b. Preformed Packing Installation. Lubricate all preformed packings with a thin coat of lubricating oil (Item 10, Appendix F) before installing. To install a preformed packing, first clean the groove, then stretch packing, and place into position. Place component on flat surface and uniformly press packing into position. Ensure preformed packings are not nicked or torn during assembly.

CAUTION

Use sealing compound sparingly and only on male threads. Do not apply compound on first two threads to avoid contamination of system from compound. Do not apply compound to hose connections or fittings with preformed packings. Damage to equipment may result.

c. Pipe Joints and Fittings. Use sealing compound, sealant, or adhesive as indicated in each maintenance task. Refer to Para 4-26 for general tightening procedure.

d. Oil Seals. Coat oil seals evenly with oil or grease before installing. Install oil seals with seal lip facing toward lubricant, applying an even force to outer edge of seal. If oil seals are to be installed over keyed or splined shafts, use a guide to prevent sharp edge of keyway or splines from cutting the leather or neoprene seal. Construct guides of very thin gage sheet metal and shape to the required diameter. Make certain guide edges are not sharp and are bent slightly inward so they do not cut the seal.

WARNING

On direct contact, uncured silicone sealant irritates eyes. In case of contact, flush eyes with water and seek medical attention. In case of skin contact, wipe off and flush with water.

e. Silicone Sealant. Silicone sealant is often used instead of a gasket to seal mating parts. The mating parts must be clean, dry, and free of oil or grease for proper adhesion. After silicone sealant has been applied, the mating parts must be assembled immediately. Silicone sealant starts to set up in 15 minutes and takes 24 hours to completely cure. Excess silicone sealant should be wiped off after assembling the mating parts.

f. Gaskets. Remove all traces of previous gasket and sealant before installing new gasket. Coat both sides of gasket with sealant to provide added sealing.

4-26. GENERAL INSTALLATION INSTRUCTIONS.

a. Preparation. When unpacking items, remove all packing material, barrier paper, tape, plastic bags, protective caps, and protective grease coatings. Handle and store removed components carefully.

CAUTION

Use sealing compound sparingly and only on male threads. Do not apply compound on first two threads to avoid contamination of system from compound. Do not apply compound to hose connections or fittings with preformed packings. Damage to equipment may result.

b. Sealing Compounds. Use sealing compounds as required in each maintenance task.

Organizational Maintenance Instructions (Cont)

4-26. GENERAL INSTALLATION INSTRUCTIONS (CONT).

c. Torquing. Tighten bolts, screws, washers, hoses, and fittings as required in Appendix J or in each maintenance task.

d. Identification Tags. Put hoses, tubes, lines, and electrical wiring in place by matching identification tags and markings on equipment.

e. Hoses, Air Lines, and Wiring. After installing hoses, air lines, and wiring, ensure that they do not contact moving parts or component edges. Secure in place, out of way, with cable ties and cushion clips.

f. Hose and Fitting Tightening Procedure.

NOTE

Tighten hoses and fittings as required in Appendix J or in each maintenance task. If a torque wrench and crowsfoot are not available or cannot be used, use the following procedure:

- (1) Install hose nut (1) on fitting (2).

NOTE

When turning effort increases, hose nut seat is in contact with fitting seat.

- (2) Tighten hose nut (1) until seated on fitting (2).

NOTE

Alignment marks allow the mechanic to count the number of flats the hose nut has rotated during tightening.

- (3) Scribe alignment mark on hose nut (1) and fitting (2).
- (4) Tighten hose nut (1) until mark on hose nut has rotated correct number of flats (refer to Table 4-4).

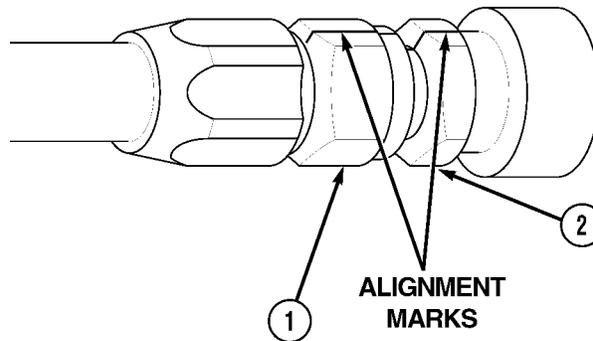
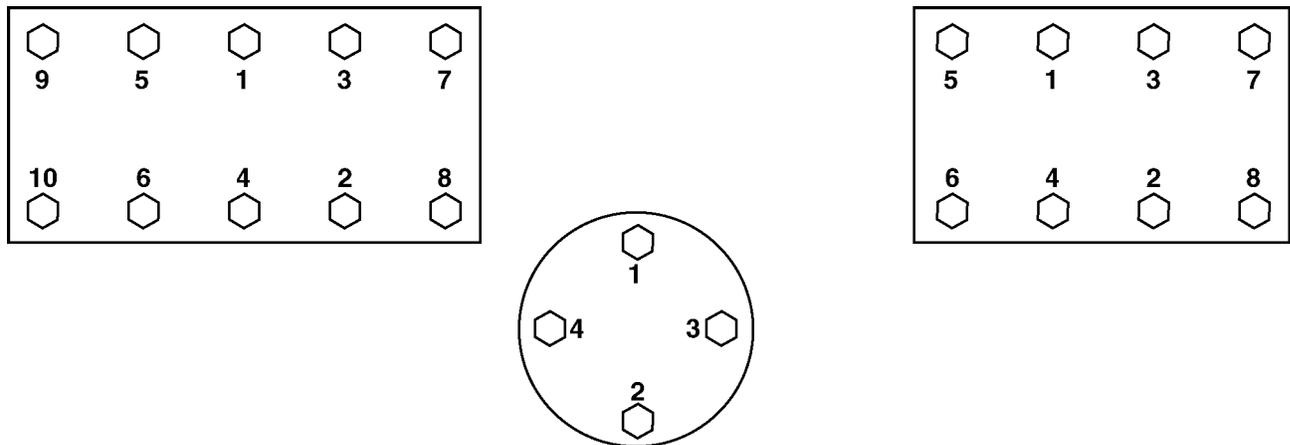

Table 4-4. Recommended Flats Rotation

Dash No.	JIC 37 Degree Flared Hose and Fitting Machined Seat	SAE 45 Degree Flared Hose and Fitting Machined Seat	JIC 37 Degree Flared Tube
-4	1 1/2 - 1 3/4	1 - 1 1/4	2 1/4 - 2 3/4
-5	1 - 1 1/2	1 - 1 1/4	2 1/4 - 2 3/4
-6	1 - 1 1/2	3/4 - 1	2 1/4 - 2 3/4
-8	1 1/4 - 1 3/4	1 - 1 1/4	2 1/4 - 2 3/4
-10	1 1/4 - 1 3/4	1 - 1 1/4	2 - 2 1/2
-12	1 - 1 1/2	1 - 1 1/4	2 - 2 1/2
-16	3/4 - 1	-----	2 1/4 - 2 3/4
-20	1/2 - 3/4	-----	1 1/4 - 2 3/4
-24	1/2 - 3/4	-----	3/4 - 1 1/4
-32	3/4	-----	1 - 1 1/4

Organizational Maintenance Instructions (Cont)

g. Fastener Tightening Sequence Procedure.**Figure 4-1. General Tightening Sequences.****NOTE**

If a component has a critical tightening sequence, it will be illustrated in that particular task; otherwise, use the general sequence charts provided (Figure 4-1).

- (1) Installation Torque.
 - (a) Tighten nuts twice in a criss-cross pattern using a torque wrench. The first time nut is torqued, apply approximately 75 percent of the final torque value.
 - (b) Repeat the sequence a second time until 100 percent of the final torque value has been obtained for each nut.

NOTE

When one or more screws are loose, check torque for all bolts on the component.

- (2) Checking Torque. Tighten nuts in a criss-cross pattern using a torque wrench. Apply 100 percent of the final torque value.

h. Pipe Thread Tightening Procedures.**WARNING**

Adhesives, solvents, and sealing compounds can burn easily, can give off harmful vapors, and are harmful to skin and clothing. To avoid injury or death, keep away from open fire and use in well-ventilated area. If adhesive, solvent, or sealing compound gets on skin or clothing, wash immediately with soap and water.

CAUTION

Use sealing compound sparingly and only on male threads. Do not apply compound on first two threads to avoid contamination of system from compound. Do not apply compound to hose connections or fittings with preformed packings. Damage to equipment may result.

- (1) Coat threads of male fitting with sealing compound, sealant, or adhesive as indicated in each maintenance task.
- (2) Position male fitting on female fitting finger-tight.
- (3) Scribe alignment mark on both fittings.

Organizational Maintenance Instructions (Cont)

4-26. GENERAL INSTALLATION INSTRUCTIONS (CONT).

CAUTION

- It may be necessary to tighten fitting slightly more or less than 2 1/2 turns to match position noted prior to removal. Do not loosen fitting to arrive at proper position or a leak may occur.
- Over-tightening may cause pipe fitting to deform and damage to the joining fitting, flange, or component.

(4) Tighten male fitting 2 1/2 (3 maximum) full turns past hand-tight position.

4-27. PREPARATION FOR STORAGE OR SHIPMENT INSTRUCTIONS.

Refer to TM 9-2320-279-20.

4-28. PREPARATION FOR STORAGE OR SHIPMENT.

Refer to TM 9-2320-279-20.

4-29. OVERVIEW (ELECTRICAL SYSTEM).

Refer to TM 9-2320-279-10 for an overview of the electrical system.

Organizational Maintenance Instructions (Cont)

4-30. GENERAL WIRE HARNESS REPAIR.

This task covers:

- | | | |
|----------------------------|-----------------------------|--------------------------|
| a. Type 1 Connector Repair | d. Type 4 Connector Repair | g. Follow-on Maintenance |
| b. Type 2 Connector Repair | e. Group I Terminal Repair | |
| c. Type 3 Connector Repair | f. Group II Terminal Repair | |

INITIAL SETUP

Models

M1120

Test Equipment

None

Special Tools

- Tool Kit, Electric, Item 31, Appendix B
- Tool Kit, General Mechanic's: Automotive, Item 33, Appendix B
- Connector Remover, Item 3, Appendix B
- Crimping Tool, Item 4, Appendix B
- Extractor Tool Electrical, Item 7, Appendix B
- Extractor Tool Electrical, Item 8, Appendix B
- Insertion Tool (Cannon), Item 14, Appendix B
- Terminal Crimper, Item 26, Appendix B
- Terminal Remover, Item 27, Appendix B
- Terminal Remover, Item 28, Appendix B
- Terminal Remover Weatherpac, Item 29, Appendix B
- Weatherpac Crimper, Item 36, Appendix B

Supplies

- Heatshrink, Item 9, Appendix F
- Tape, Item 25, Appendix F

Personnel Required

MOS 63S, Heavy wheel vehicle mechanic

References

TM 43-0158

Equipment Condition

<i>TM or Para</i>	<i>Condition Description</i>
TM 9-2320-279-10	Engine OFF
TM 9-2320-279-10	Wheels chocked
TM 9-2320-279-20	Batteries disconnected

Special Environmental Conditions

None

General Safety Instructions

None

Organizational Maintenance Instructions (Cont)

4-30. GENERAL WIRE HARNESS REPAIR (CONT).

a. Type 1 Connector Repair.

CAUTION

Terminals come in different styles and sizes. To prevent damage, be sure to use only the exact replacements. Do not attempt to modify terminal to fit.

NOTE

Repeat procedure as necessary.

(1) *Disassembly.*

- (a) Unscrew cover (1).
- (b) Slide plastic sleeve (2) back.
- (c) Remove wire (3) and terminal (4) from connector (5).

NOTE

Cut as close to damaged terminal as possible.

- (d) Cut off terminal (4) at end of wire (3). Remove insulation (6) 1/4 inch (.6 cm) from end of wire (3). Discard terminal.

(2) *Assembly.*

- (a) Install terminal (1) on wire (2) and crimp in place.
- (b) Install terminal (1) on connector (3).
- (c) Install sealing plugs (4) in unused holes.
- (d) Slide plastic sleeve (5) against connector (3).
- (e) Install cover (6) on connector (3).

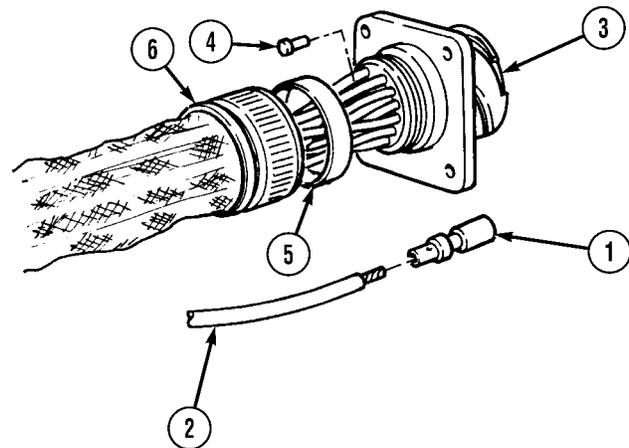
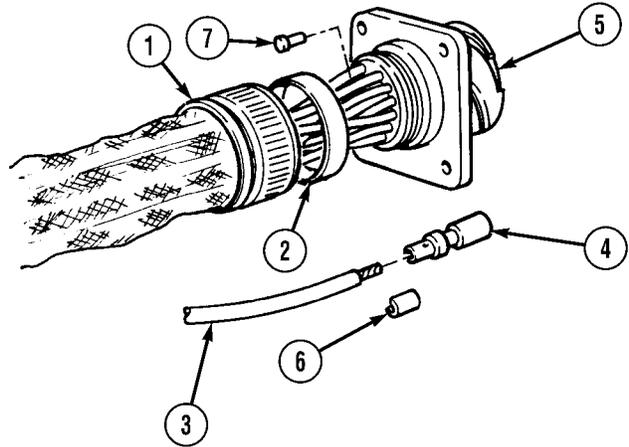

Organizational Maintenance Instructions (Cont)

b. Type 2 Connector Repair.**CAUTION**

Terminals come in different styles and sizes. To prevent damage, be sure to use only the exact replacements. Do not attempt to modify terminal to fit.

NOTE

Repeat procedure as necessary.

(1) Disassembly.

- (a) Remove two screws (1) and cable clamp (2) from connector (3).
- (b) Remove heat shrink (4).
- (c) Remove wire (5) and terminal (6) from connector (3).

NOTE

Cut as close to damaged terminal as possible.

- (d) Cut off terminal (6) at end of wire (5). Remove insulation (7) 1/4 inch (.635 cm) from end of wire (3). Discard terminal.

(2) Assembly.

- (a) Install terminal (1) on connector (2).
- (b) Install cable clamp (3) on connector (2) with two screws (4).
- (c) Install heat shrink (5) around wires (6).

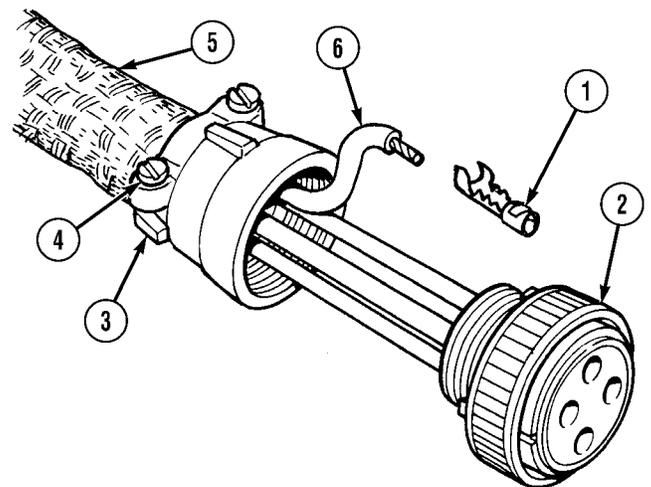
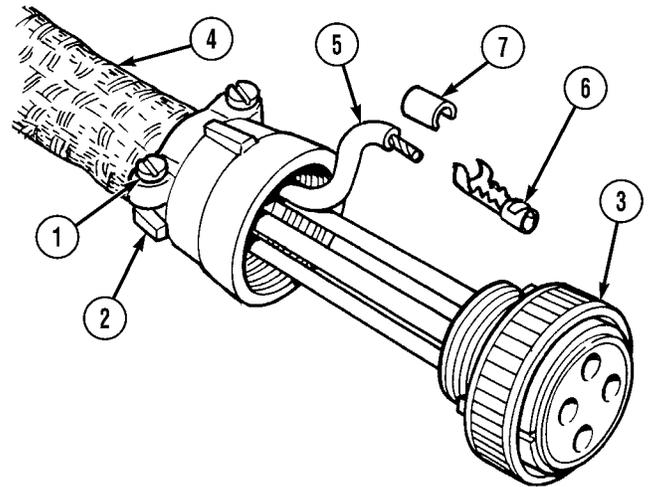

Organizational Maintenance Instructions (Cont)

4-30. GENERAL WIRE HARNESS REPAIR (CONT).

c. Type 3 Connector Repair.

(1) *Disassembly.*

- (a) Slide outer shell (1) back on wire (2).
- (b) Remove C-washer (3) from wire (2).
- (c) Cut terminal (4) from wire (2).
- (d) Trim end of wire (2) as needed to make an undamaged end.

NOTE

If trimming causes wire to become too short, refer to TM 43-0158.

- (e) Remove 0.375 in. (1.0 cm) of insulation (5) from end of wire (2).

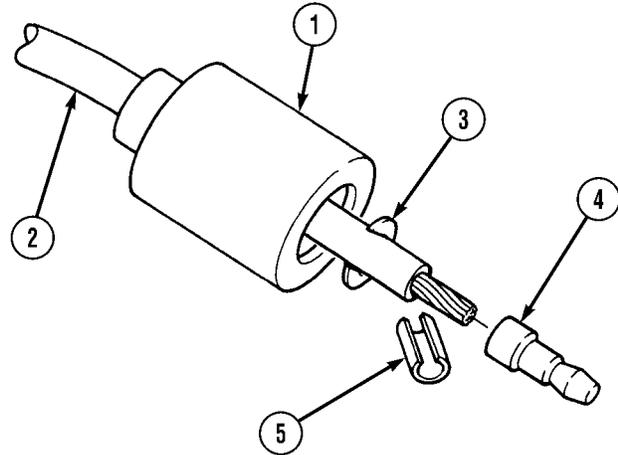

(2) *Assembly.*

- (a) Install terminal (1) on wire (2).
- (b) Install C-washer (3) on wire (2) just below terminal (1).
- (c) Slide outer shell (4) over C-washer (3) and terminal (1).
- (d) Be sure no bare wire (2) is visible outside of outer shell (4).

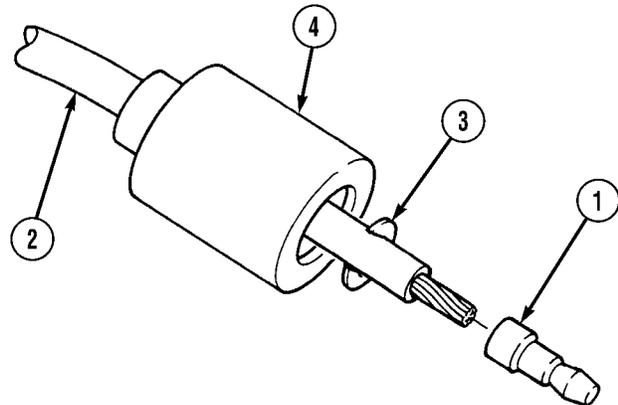

d. Type 4 Connector Repair.

(1) *Disassembly.*

- (a) Slide outer shell (1) and sleeve (2) back on wire (3).
- (b) Remove contact (4) from wire (3).
- (c) Trim end of wire (3) as needed to make an undamaged end.

NOTE

If trimming causes wire to become too short, refer to TM 43-0158.

- (d) Remove 1/4 in. (.6 cm) of insulation (5) from end of wire (3).

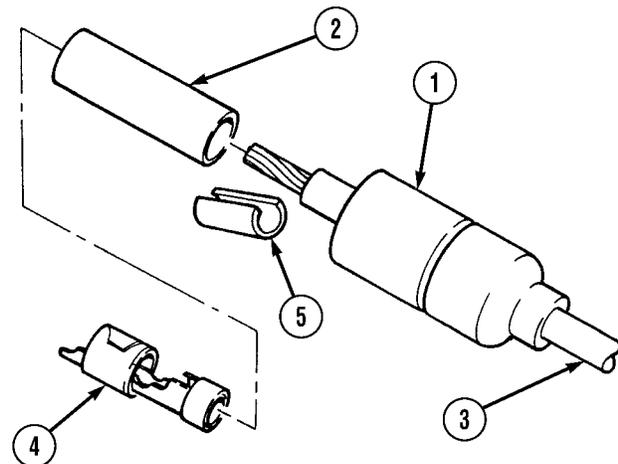

Organizational Maintenance Instructions (Cont)

(2) *Assembly.*

- (a) Install sleeve (1) over end of wire (2).
- (b) Install contact (3) over end of wire (2).
- (c) Crimp contact (3) securely in place.
- (d) Slide outer shell (4) over sleeve (1) and contact (3).
- (e) Be sure no bare wire (2) shows outside of outer shell (4).

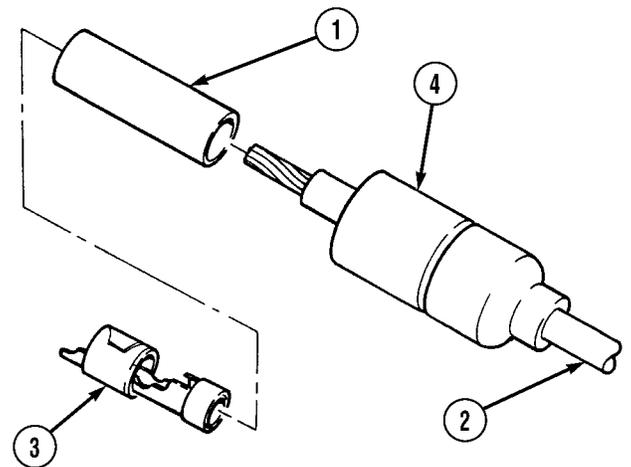

e. Group I Terminal Repair.

(1) *Disassembly.*

NOTE

- Connector is removed by gently prying up on clip and pulling on connector.
 - All Group I connectors are repaired the same way. Number of wires in connector may vary.
 - Both halves of connector are repaired the same way.
- (a) Disconnect connector (1).
 - (b) Unlatch and open two secondary locks (2) on connector (1).

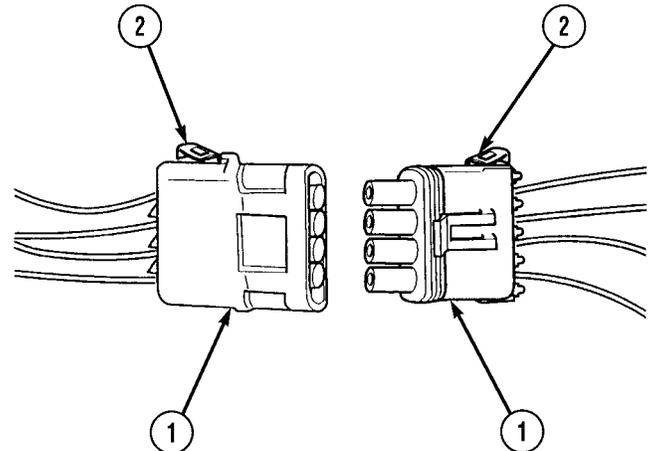

Organizational Maintenance Instructions (Cont)

4-30. GENERAL WIRE HARNESS REPAIR (CONT).

WARNING

Tip of removal tool is very sharp. Use caution when using tool. Failure to comply may result in injury to personnel.

- (c) Insert removal tool into cavity (3) on connector (1) until seated.
- (d) Pull wire (4) back through connector (1) and remove tool.

NOTE

- Do step (e) only if old terminal is still attached to wire.
- Make cut directly behind damaged terminal.
- (e) Cut terminal (5) and wire seal (6) from wire (4). Discard terminal and seal.

(2) *Assembly.*

- (a) Insert 1 in. (2.5 cm) of wire (1) through new wire seal (2).

CAUTION

Strip wire after placing it through seal to prevent damage to individual wire strands.

- (b) Strip end of wire (1) leaving 1/4 in. (0.6 cm) of bare wire.

- (c) Insert new terminal (3) in locating hole of crimp tool using proper hole according to the gage of wire (1).
- (d) Slide seal (2) down to end of insulation (4) on wire (1).

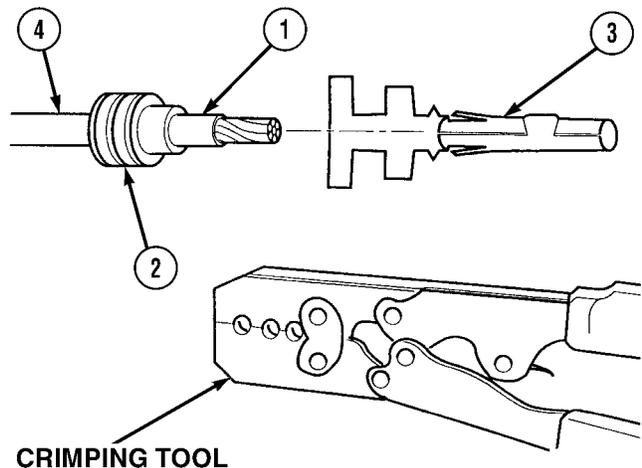
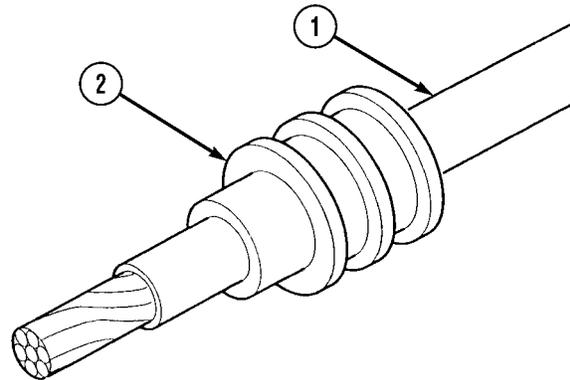
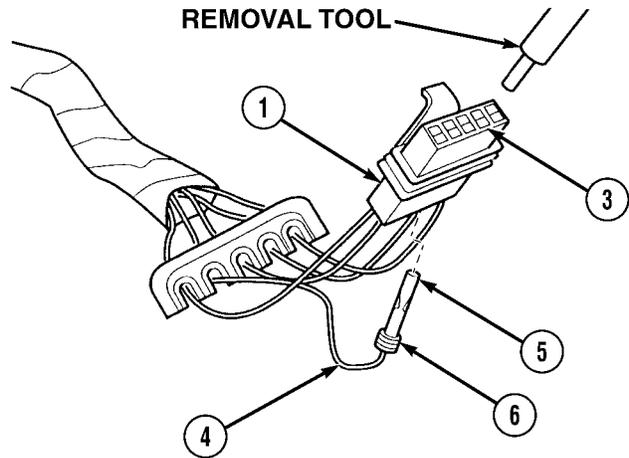

Organizational Maintenance Instructions (Cont)

NOTE

Wire and seal should be positioned so larger wings of terminal will crimp around seal and smaller wings will crimp around exposed bare wire.

- (e) Position wire (1) on terminal (3).
- (f) Press handles of crimp tool together until ratchet releases and crimp is complete.
- (g) Push new terminal (3) and wire (1) through connector (5) until seated.
- (h) Close two secondary locks (6) on connector (5).
- (i) Connect connector (5).

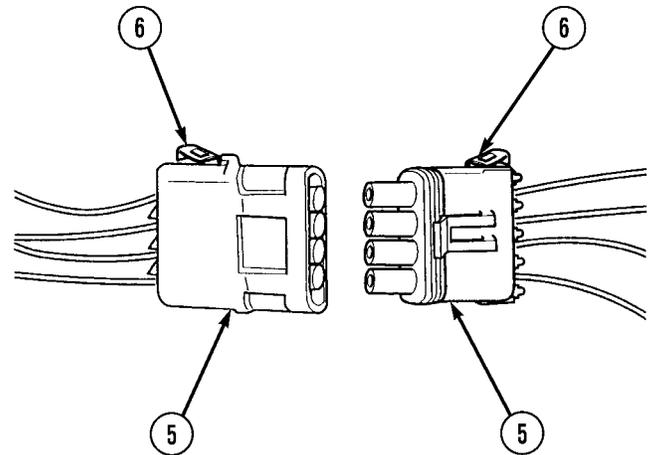
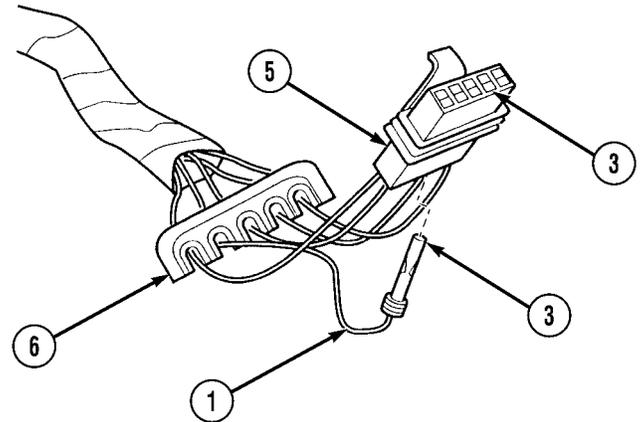

f. Group II Terminal Repair.

(1) Disassembly.

NOTE

- Connector is removed by gently prying up on clip and pulling on connector.
- All Group II connectors are repaired the same way. Number of wires in connector may vary.
- Both halves of connector are repaired the same way.

- (a) Disconnect connector (1).
- (b) Unlatch and remove two secondary locks (2) on connector (1).

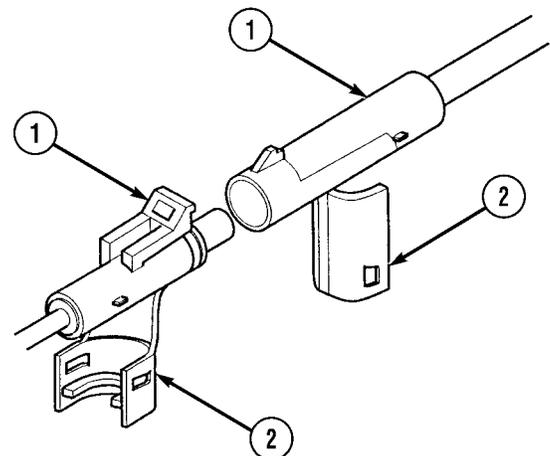

Organizational Maintenance Instructions (Cont)

4-30. GENERAL WIRE HARNESS REPAIR (CONT).

WARNING

Tip of removal tool is very sharp. Use caution when using tool. Failure to comply may result in injury to personnel.

- (c) Insert removal tool into terminal connector cavity (3) until seated.
- (d) Pull wire (4) back through connector (1) and removal tool.

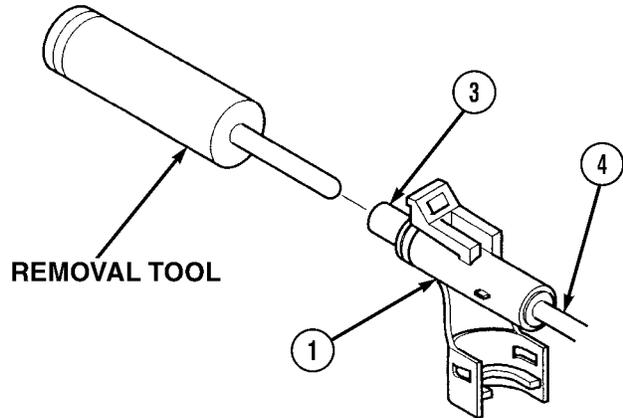

NOTE

- Do step (e) only if old terminal is still attached to wire.
- Make cut directly behind damaged terminal.
- (e) Cut off terminal (5) and wire seal (6). Discard terminal and seal.

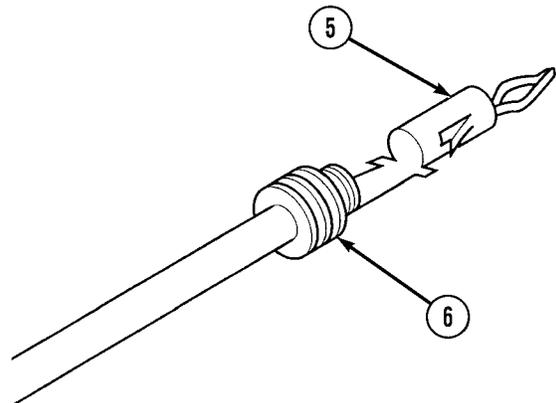

(2) *Assembly.*

- (a) Insert 1 in. (2.5 cm) of wire (4) through new wire seal (6).

CAUTION

Strip wire after placing it through seal to prevent damage to individual wire strands.

- (b) Strip end of wire (1) leaving 0.25 in. (0.6 cm) of bare wire.

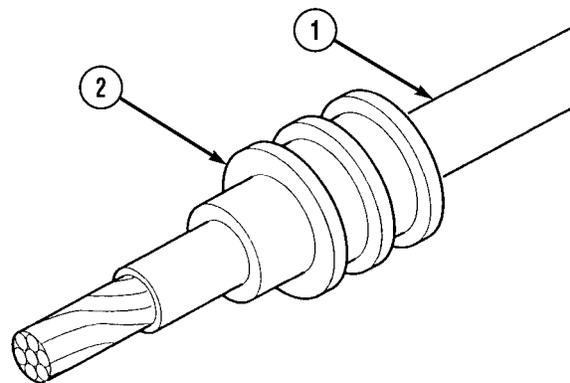

Organizational Maintenance Instructions (Cont)

- (c) Insert new terminal (5) in locating hole of crimp tool using the proper hole according to gage of wire (1).
- (d) Slide wire seal (2) down to end of insulation (3) on wire (1).

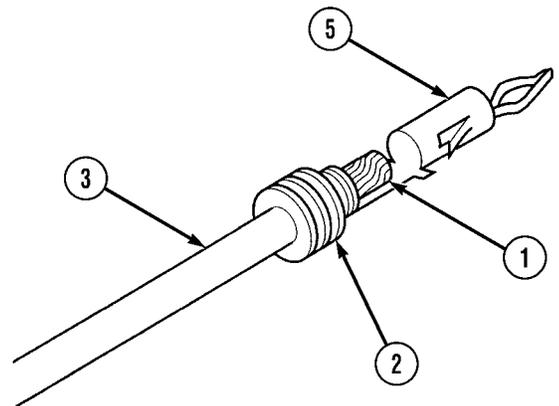

NOTE

Wire and seal should be positioned so larger wings of terminal will crimp around insulation and smaller wings will crimp around exposed bare wire.

- (e) Position wire (1) on terminal (3).
- (f) Press handles of crimp tool together until ratchet releases and crimp is complete.
- (g) Push new terminal (3) and wire (1) through connector (4) until seated.

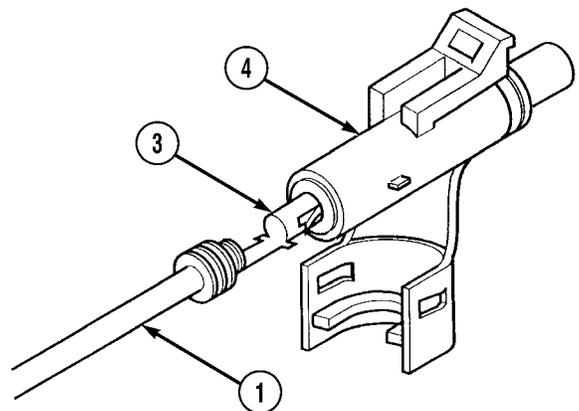

- (h) Install two secondary locks (5) on connector (4).
- (i) Connect connector (4).

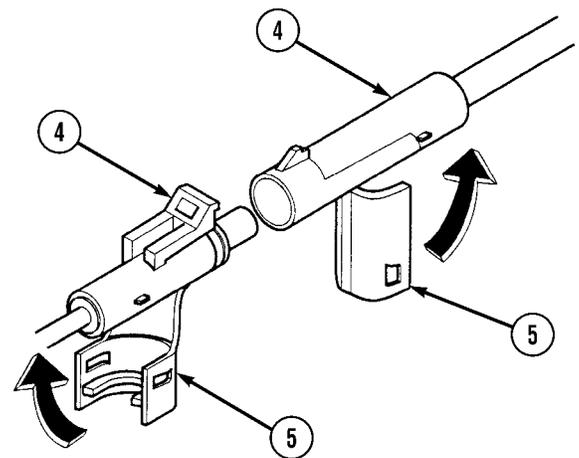

g. Follow-on Maintenance.

- (1) Connect batteries (TM 9-2320-279-20).
- (2) Remove wheel chocks (TM 9-2320-279-10).

END OF TASK

Organizational Maintenance Instructions (Cont)

4-31. HYDRAULIC SELECTOR SWITCH REPLACEMENT.		
This task covers:		
a. Removal	b. Installation	c. Follow-on Maintenance
INITIAL SETUP		
<i>Models</i>	<i>Equipment Condition</i>	
M1120	<i>TM or Para</i>	<i>Condition Description</i>
	TM 9-2320-279-10	Engine OFF
<i>Test Equipment</i>	TM 9-2320-279-10	Wheels chocked
None	TM 9-2320-279-20	Batteries disconnected
<i>Special Tools</i>	TM 9-2320-279-20	Heater compartment cover removed
Tool Kit, General Mechanic's: Automotive, Item 33, Appendix B	TM 9-2320-279-20	Side panel removed
<i>Supplies</i>	<i>Special Environmental Conditions</i>	
Tags, Identification, Item 19, Appendix F	None	
<i>Personnel Required</i>	<i>General Safety Instructions</i>	
MOS 63S, Heavy wheel vehicle mechanic	None	
<i>References</i>		
None		

Organizational Maintenance Instructions (Cont)

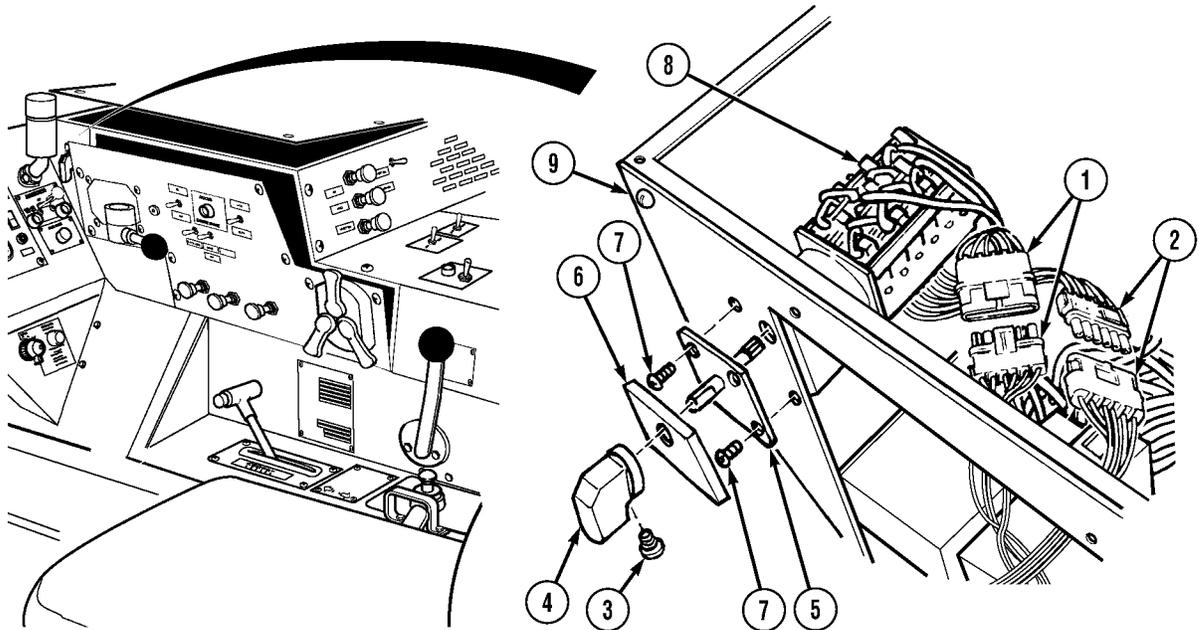
a. Removal.**NOTE**

Connectors are disconnected by gently prying up on tab and pulling connectors apart.

- (1) Disconnect MC93 connector (1).
- (2) Disconnect MD94 connector (2).
- (3) Loosen screw (3) and remove knob (4) from hydraulic selector switch front mounting plate (5).

NOTE

Hydraulic selector switch face plate snaps in place.

- (4) Remove hydraulic selector switch face plate (6) from hydraulic selector switch front mounting plate (5).
- (5) Remove four screws (7), hydraulic selector switch front mounting plate (5), and hydraulic selector switch (8) from heater compartment (9).

Organizational Maintenance Instructions (Cont)

4-31. HYDRAULIC SELECTOR SWITCH REPLACEMENT (CONT).

NOTE

Tag and mark wires prior to removal.

- (6) Loosen eleven captive screws (10) and remove wires 1724 (11), 1487 (12), 1483 (13), 1481 (14), 1480 (15), 1486 (16), 1482 (17), 1484 (18), and 1485 (19) from hydraulic selector switch (8).
- (7) Remove two jumperwires (20) from hydraulic selector switch (8).

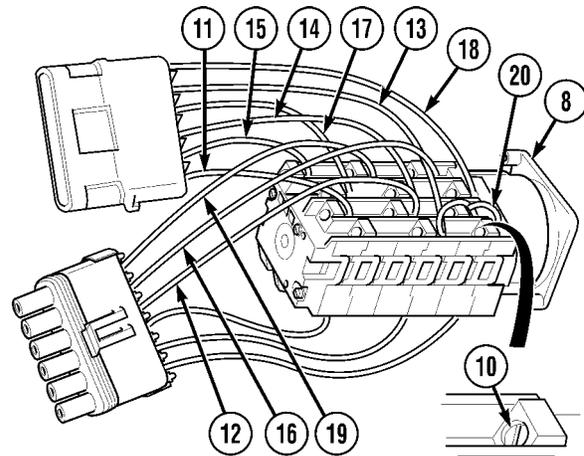

- (8) Loosen twelve captive screws (21) and remove wires 1488 (22), 1489 (23), and 1490 (24).
- (9) Remove nine jumperwires (25) from hydraulic selector switch (8).

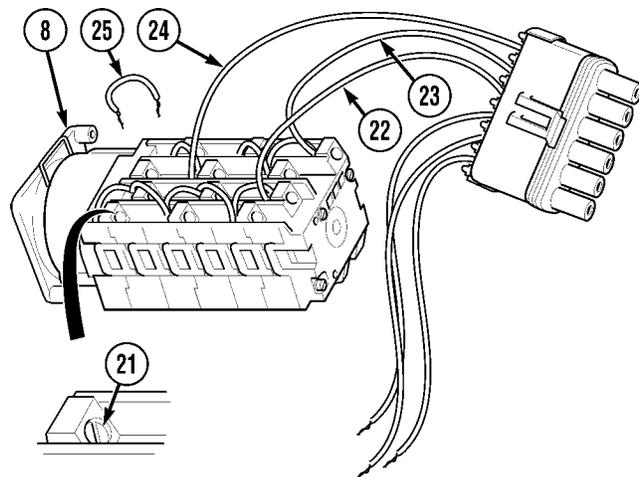

b. Installation.

- (1) Install three wires 1488 (1), 1489 (2), and 1490 (3) in hydraulic selector switch (4) with three captive screws (5).
- (2) Install nine jumperwires (6) in hydraulic selector switch (4) with nine captive screws (5).

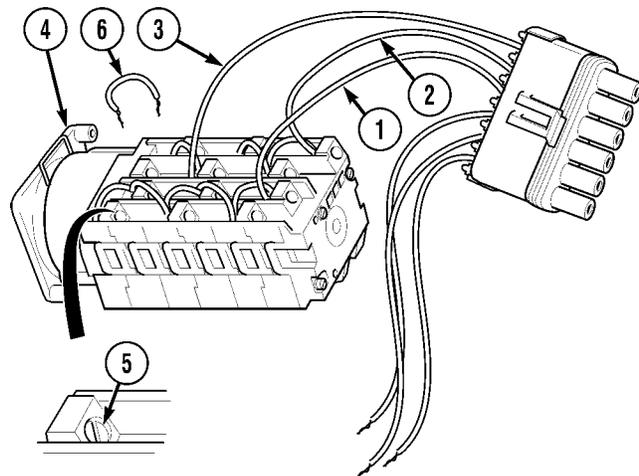

Organizational Maintenance Instructions (Cont)

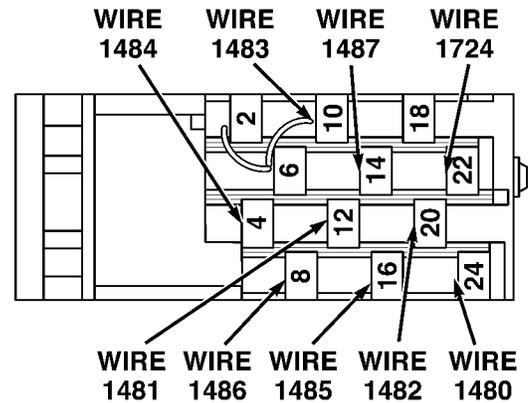
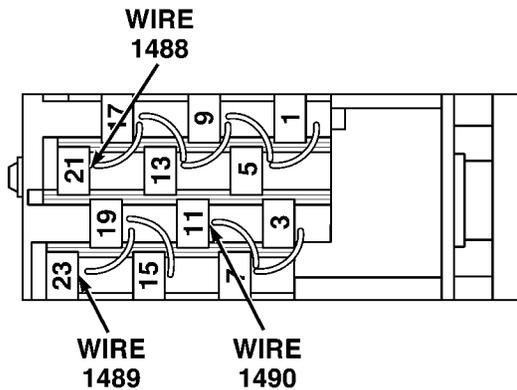

- (3) Install wires 1724 (7), 1487 (8), 1483 (9), 1481 (10), 1480 (11), 1486 (12), 1482 (13), 1484 (14), and 1485 (15) in hydraulic selector switch (4) with nine screws (16).
- (4) Install two jumperwires (17) in hydraulic selector switch (4) with two screws (16).

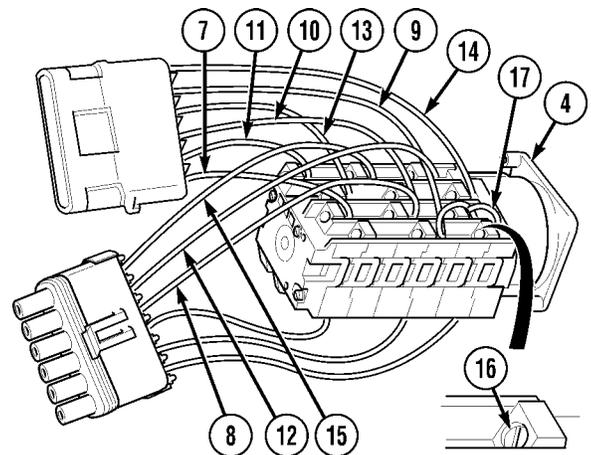

- (5) Install hydraulic selector switch (4), hydraulic selector switch front mounting plate (18), and four screws (19) on heater compartment (20).

NOTE

Hydraulic selector switch face plate snaps in place.

- (6) Install hydraulic selector switch face plate (21) on hydraulic selector switch front mounting plate (18).
- (7) Install knob (22) on hydraulic selector switch front mounting plate (18) with screw (23).
- (8) Connect MC94 connector (24).
- (9) Connect MC93 connector (25).

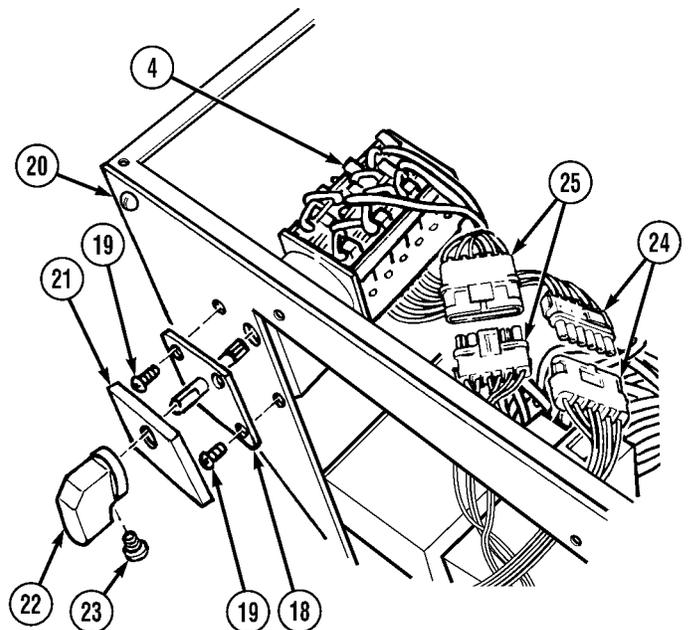

Organizational Maintenance Instructions (Cont)

4-31. HYDRAULIC SELECTOR SWITCH REPLACEMENT (CONT).

c. Follow-on Maintenance.

- (1) Install side panel (TM 9-2320-279-20).
- (2) Install heater compartment cover (TM 9-2320-279-20).
- (3) Connect batteries (TM 9-2320-279-20).
- (4) Start engine (TM 9-2320-279-10).
- (5) Check hydraulic selector switch operation (Para 2-9).
- (6) Shut OFF engine (TM 9-2320-279-10).
- (7) Remove wheel chocks (TM 9-2320-279-10).

END OF TASK

Organizational Maintenance Instructions (Cont)

4-32. PILOT LIGHT HOUSING REPLACEMENT.		
This task covers:		
a. Removal	b. Installation	c. Follow-on Maintenance
INITIAL SETUP		
<i>Models</i> M1120	<i>References</i> None	
<i>Test Equipment</i> None	<i>Equipment Condition</i>	
<i>Special Tools</i> Tool Kit, General Mechanic's Automotive, Item 33, Appendix B	TM 9-2320-279-10	Engine OFF
	TM 9-2320-279-10	Wheels chocked
	TM 9-2320-279-20	Batteries disconnected
	TM 9-2320-279-20	Dash panel removed
<i>Supplies</i> None	<i>Special Environmental Conditions</i> None	
<i>Personnel Required</i> MOS 63S, Heavy wheel vehicle mechanic	<i>General Safety Instructions</i> None	

a. Removal.

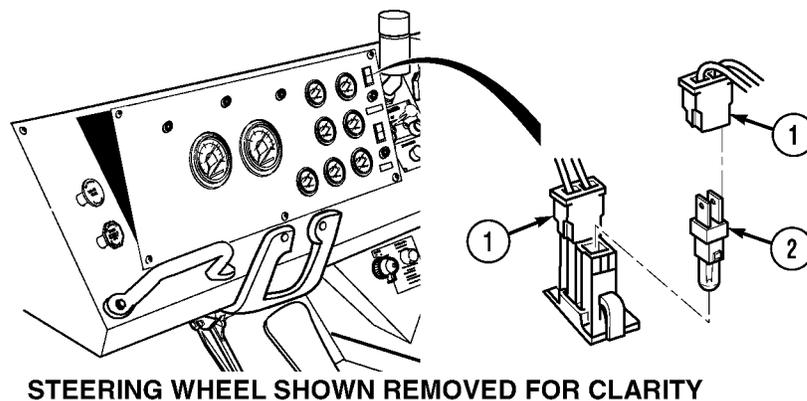

NOTE

Both pilot light housings are removed and installed the same way. The top housing is shown.

- (1) Tag and remove electrical connectors (1).
- (2) Remove indicator bulb (2).

Organizational Maintenance Instructions (Cont)

4-32. PILOT LIGHT HOUSING REPLACEMENT (CONT).

- (3) Push clip (3) in and remove pilot light housing (4).

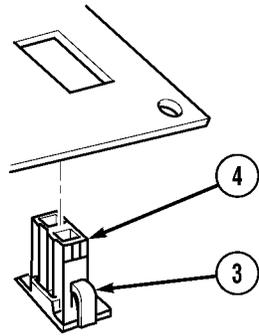

b. Installation.

- (1) Install pilot light housing (1) into dash panel (2). Make sure clip (3) engages dash panel (2).

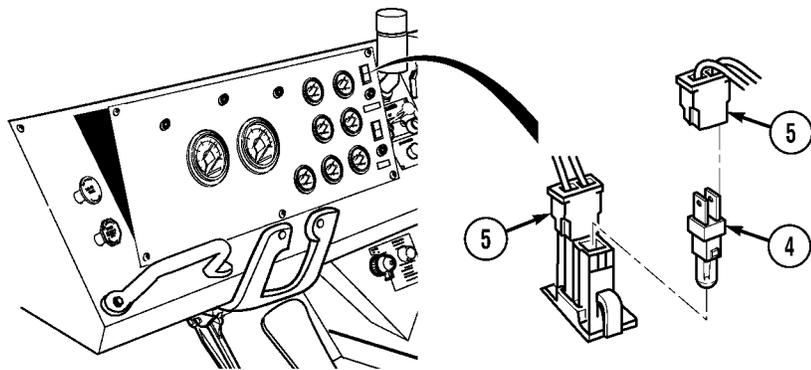
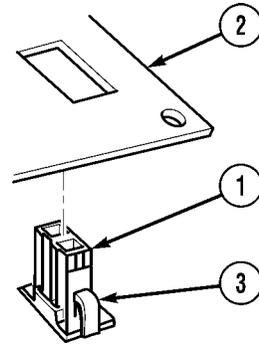

STEERING WHEEL SHOWN REMOVED FOR CLARITY

- (2) Install indicator bulb (4) in pilot light housing (1).
- (3) Install electrical connectors (5).

c. Follow-on Maintenance.

- (1) Install dash panel (TM 9-2320-279-20).
- (2) Connect batteries (TM 9-2320-279-20).
- (3) Remove wheel chocks (TM 9-2320-279-10).

END OF TASK

Organizational Maintenance Instructions (Cont)

4-33. LHS CIRCUIT BREAKER REPLACEMENT.		
This task covers:		
a. Removal	b. Installation	c. Follow-on Maintenance
INITIAL SETUP		
<i>Models</i> M1120	<i>References</i> None	
<i>Test Equipment</i> None	<i>Equipment Condition</i> <i>TM or Para</i> <i>Condition Description</i> TM 9-2320-279-20 Batteries disconnected TM 9-2320-279-10 Wheels chocked	
<i>Special Tools</i> Tool Kit, General Mechanic's Automotive, Item 33, Appendix B	<i>Special Environmental Conditions</i> None	
<i>Supplies</i> Tags, Identification Item 20, Appendix F	<i>General Safety Instructions</i> None	
<i>Personnel Required</i> MOS 63S, Heavy wheel vehicle mechanic		

a. Removal.

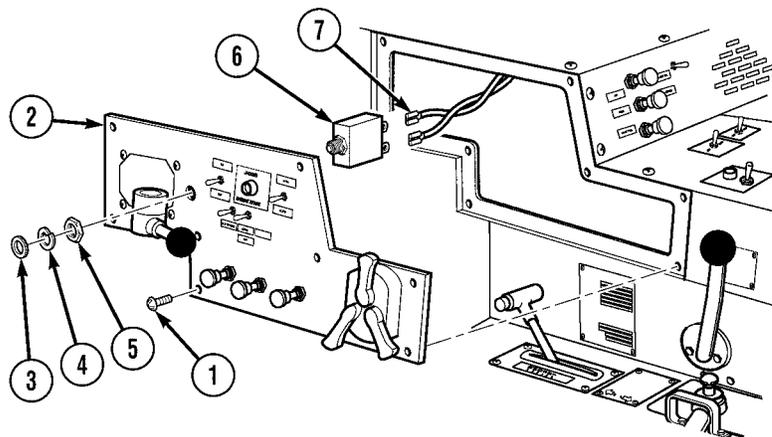

- (1) Remove eight screws (1) and side panel (2).
- (2) Remove nut (3), washer (4), nut (5), and circuit breaker (6) from side panel (2).

NOTE

Tag and mark wires before disconnecting

- (3) Disconnect wires (7).

Organizational Maintenance Instructions (Cont)

4-33. LHS CIRCUIT BREAKER REPLACEMENT (CONT).

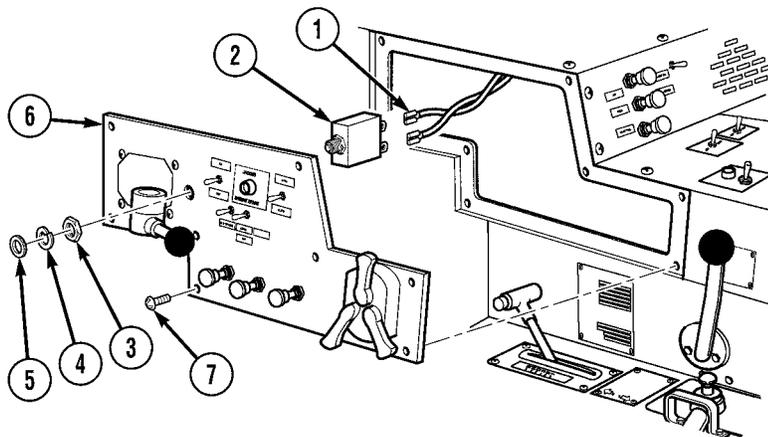

b. Installation.

- (1) Connect wires (1) to circuit breaker (2).
- (2) Install circuit breaker (2), nut (3), washer (4), and nut (5) on side panel (6). Tighten nut.
- (3) Position side panel (6) and make sure all wires (1) are behind side panel (6). Install and tighten eight screws (7).

c. Follow-on Maintenance.

- (1) Connect batteries (TM 9-2320-279-20).
- (2) Remove wheel chocks (TM 9-2320-279-10).

END OF TASK

Organizational Maintenance Instructions (Cont)

4-33.1 CONTAINER HANDLING UNIT (CHU) JUMPERWIRE HARNESS REPLACEMENT.		
This task covers:		
a. Removal	b. Installation	c. Follow-on Maintenance
INITIAL SETUP		
<i>Models</i> M1120	<i>References</i> None	
<i>Test Equipment</i> None	<i>Equipment Condition</i> <i>TM or Para</i> <i>Condition Description</i> TM 9-2320-279-10 Engine OFF TM 9-2320-279-10 Wheels chocked TM 9-2320-279-20 Batteries disconnected	
<i>Special Tools</i> Tool Kit, General Mechanic's Automotive, Item 33, Appendix B	<i>Special Environmental Conditions</i> None	
<i>Supplies</i> Cable Ties, Item 4, Appendix F Tags, Identification, Item 19, Appendix F	<i>General Safety Instructions</i> None	
<i>Personnel Required</i> MOS 63S, Heavy wheel vehicle mechanic		

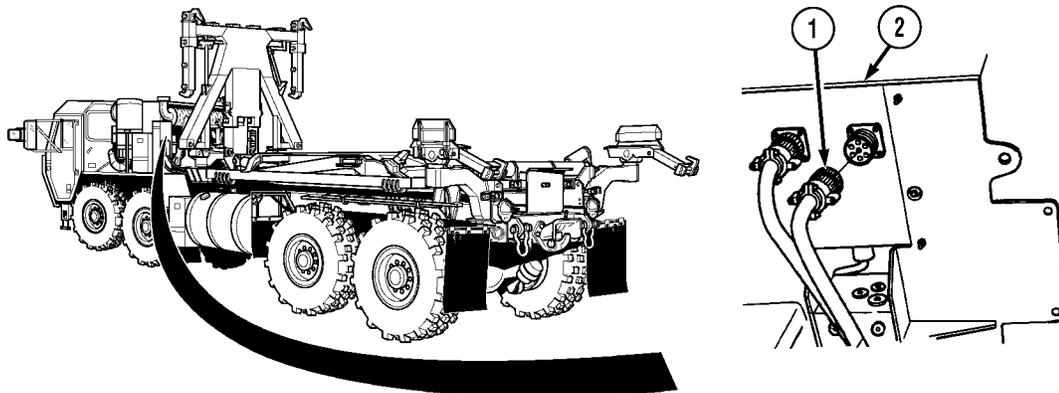

a. Removal.

NOTE

- Tag and mark all wires and connectors prior to removal.
- Note routing of CHU jumperwire harness prior to removal.
- Remove cable ties as required.

(1) Disconnect MC82 connector (1) from LHS main junction box (2).

Organizational Maintenance Instructions (Cont)

4-33.1 CONTAINER HANDLING UNIT (CHU) JUMPERWIRE HARNESS REPLACEMENT (CONT).

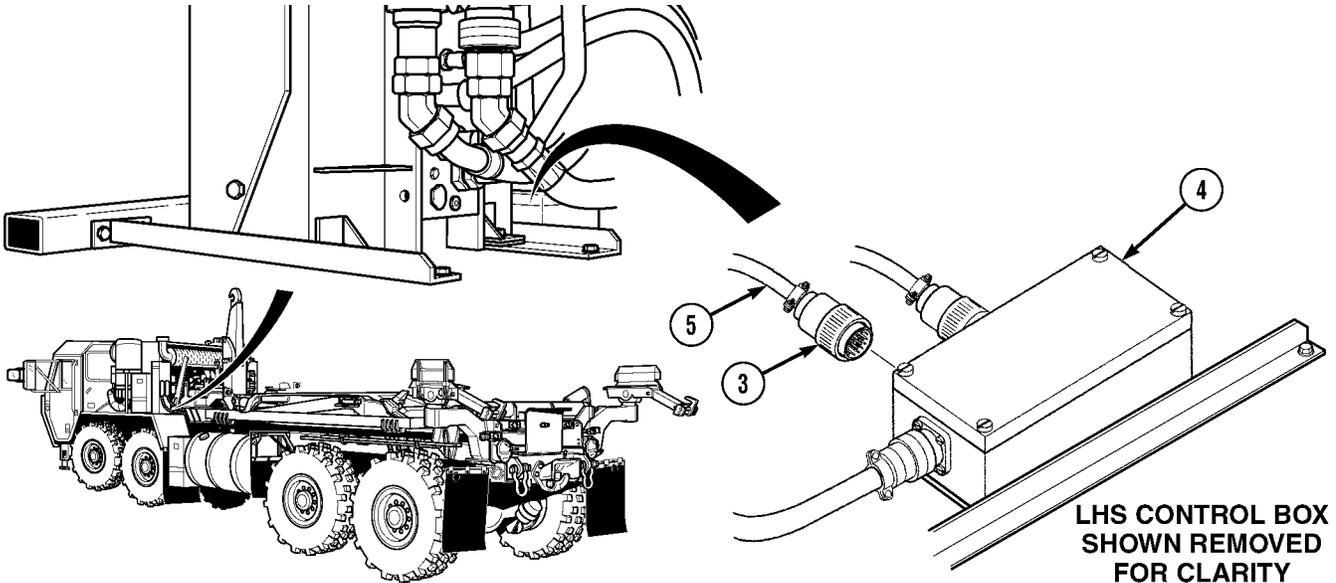

- (2) Disconnect MC82B connector (3) from CHU control box (4).
- (3) Remove CHU jumper harness (5) from truck.

b. Installation.

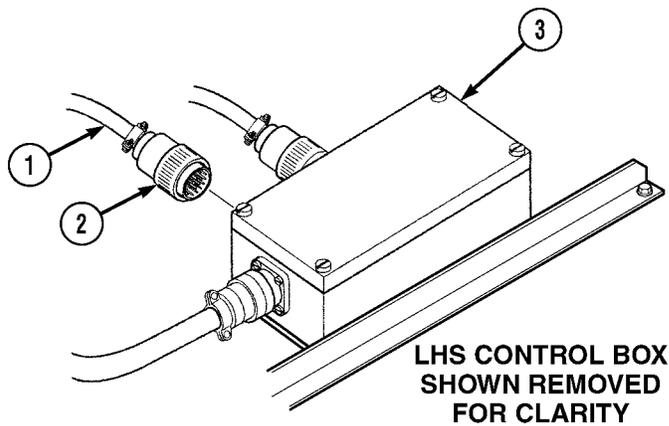

NOTE

- Install cable ties as required.
 - Position CHU jumperwire harness as noted during removal.
- (1) Position CHU jumper harness (1) in truck.
 - (2) Connect MC82B connector (2) to CHU control box (3).

Organizational Maintenance Instructions (Cont)

- (3) Connect MC85 connector (4) to LHS main junction box (5).

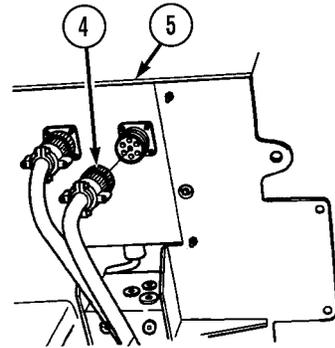
**c. Follow-on Maintenance.**

- (1) Connect batteries (TM 9-2320-279-20).
(2) Remove wheel chocks (TM 9-2320-279-10).

END OF TASK

Organizational Maintenance Instructions (Cont)

4-33.2 CONTAINER HANDLING UNIT (CHU) WIRE HARNESS REPLACEMENT.

This task covers:

- a. Removal
- b. Installation
- c. Follow-on Maintenance

INITIAL SETUP

Models

M1120

Test Equipment

None

Special Tools

Tool Kit, General Mechanic's Automotive, Item 33, Appendix B

Supplies

Cable Ties, Item 4, Appendix F
Tags, Identification, Item 19, Appendix F

Personnel Required

MOS 63S, Heavy wheel vehicle mechanic

References

None

Equipment Condition

<i>TM or Para</i>	<i>Condition Description</i>
TM 9-2320-279-10	Engine OFF
TM 9-2320-279-10	Wheels chocked
TM 9-2320-279-20	Batteries disconnected

Special Environmental Conditions

None

General Safety Instructions

None

a. Removal.

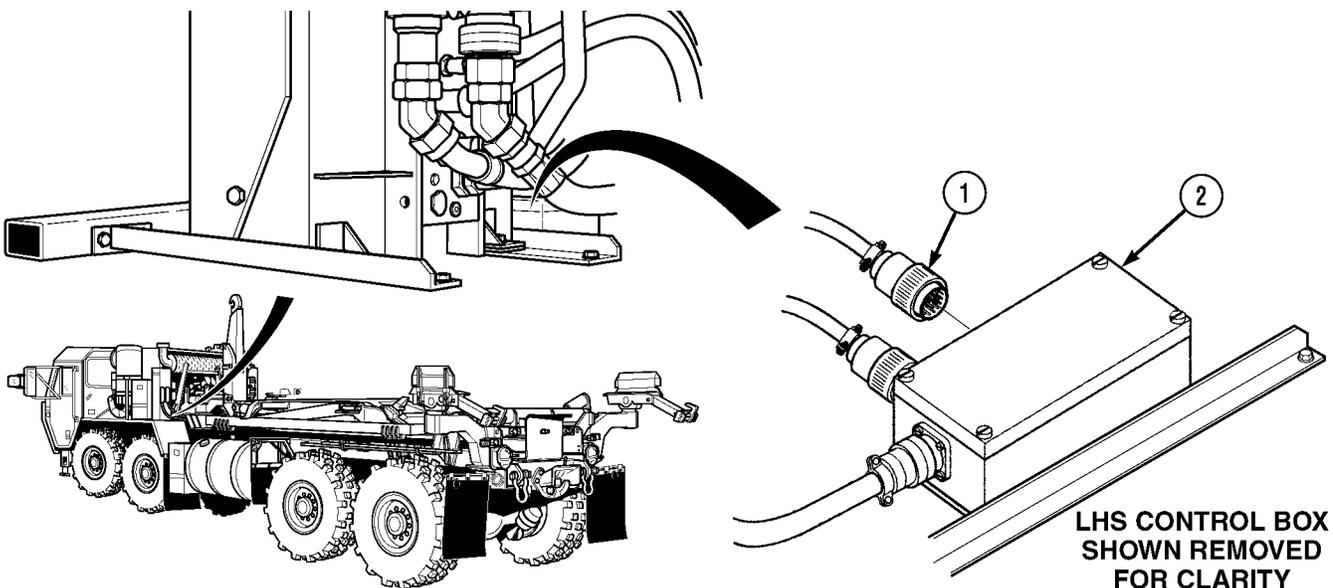

NOTE

- Tag and mark all wires and connectors prior to removal.
- Remove cable ties as required.

(1) Disconnect MC185A connector (1) from CHU control box (2).

Organizational Maintenance Instructions (Cont)

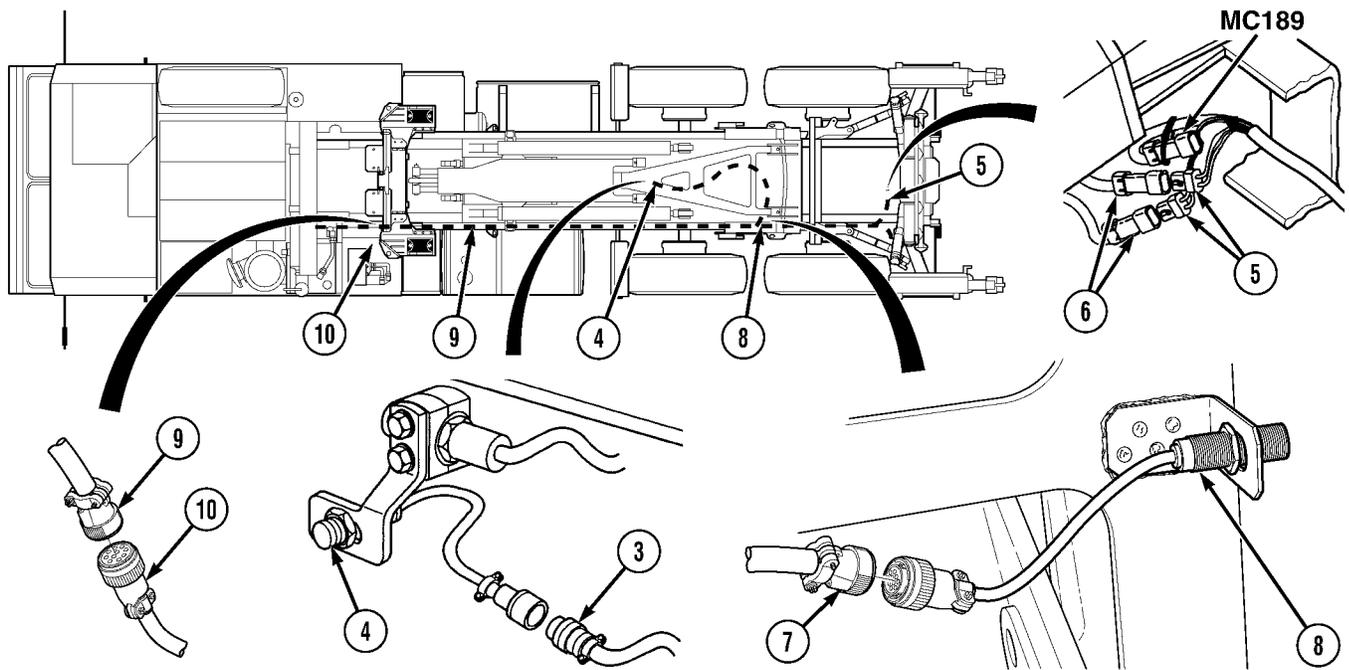

NOTE

- Remove cable ties as required.
- Connector MC189 does not connect to anything. MC189 is removed with the CHU wiring harness.

- (2) Disconnect MC188 connector (3) from CHU hook arm up proximity switch (4).
- (3) Disconnect two MC190 connectors (5) from right and left rear lock limit switches (6).
- (4) Disconnect MC186 connector (7) from CHU main frame proximity switch (8).
- (5) Remove CHU wire harness (9) and main frame proximity switch wire harness (10) from truck.
- (6) Disconnect CHU wire harness (9) from main frame proximity switch wire harness (10) at connector MC185.

Organizational Maintenance Instructions (Cont)

4-33.2 CONTAINER HANDLING UNIT (CHU) WIRE HARNESS REPLACEMENT (CONT).

b. Installation.

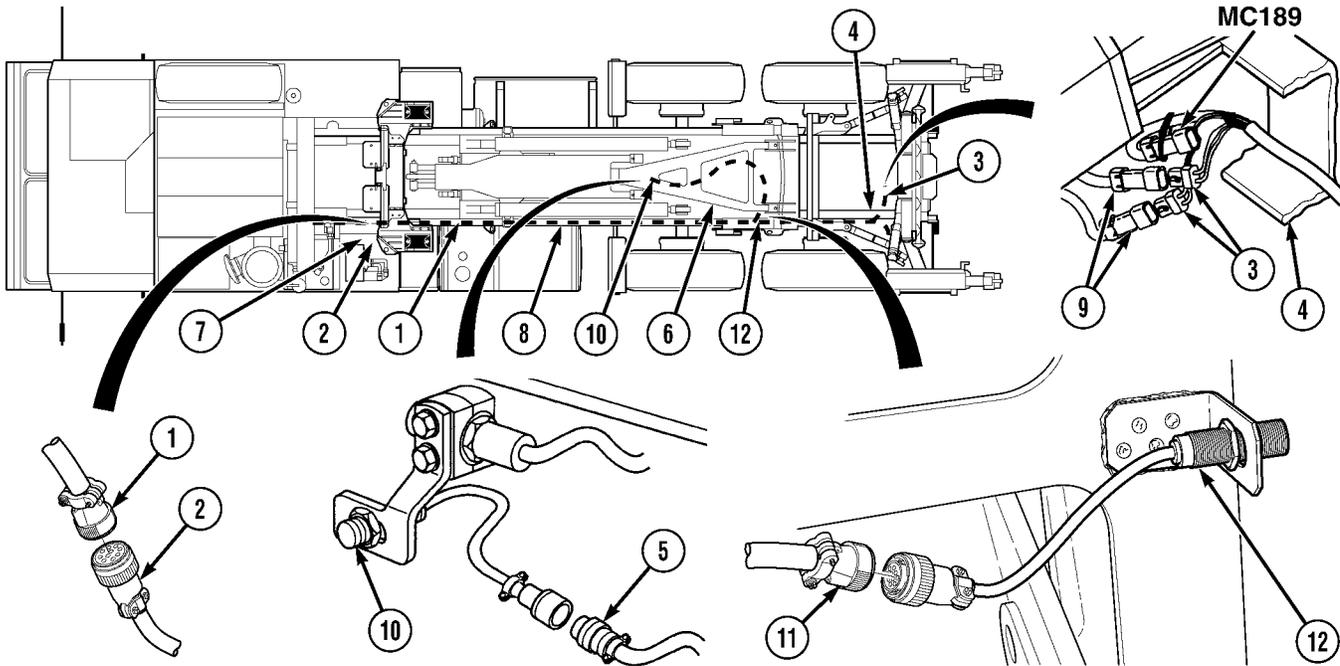

NOTE

- Install cable ties as required.
- Connector MC189 does not connect to anything. MC189 is installed with the CHU wiring harness.

- (1) Connect CHU wire harness (1) to main frame proximity switch wire harness (2) at connector MC185.
- (2) Position CHU wire harness (1), main frame proximity switch wire harness (2), and two MC190 connectors (3) along inside of frame (4).
- (3) Position CHU wire harness (1) with MC188 connector (5) along inside of main frame (6) with existing wires.
- (4) Position CHU wire harness with MC185A connector (7) along inside of compression frame (8) with existing wires.
- (5) Connect two MC190 connectors (3) to right and left rear lock limit switches (9).
- (6) Connect MC188 connector (5) to hook arm up proximity switch (10).
- (7) Connect MC186 connector (11) to CHU main frame proximity switch (12).

Organizational Maintenance Instructions (Cont)

- (8) Connect MC185A connector (7) to CHU control box (13).

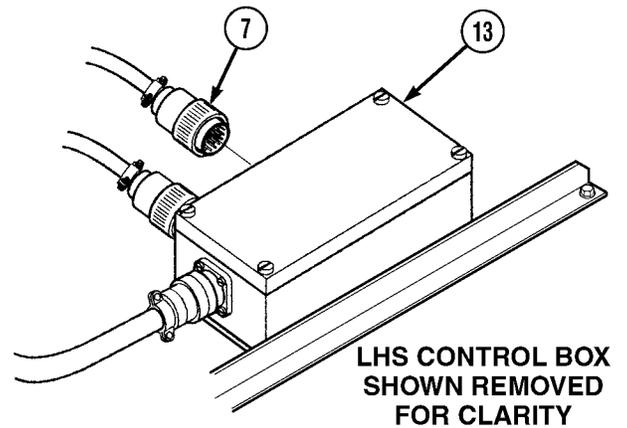
**c. Follow-on Maintenance:**

- (1) Connect batteries (TM 9-2320-279-20).
- (2) Remove wheel chocks (TM 9-2320-279-10).

END OF TASK

Organizational Maintenance Instructions (Cont)

4-34. LOAD HANDLING SYSTEM (LHS) DISTRIBUTION BOX REPLACEMENT.		
This task covers:		
a. Removal	b. Installation	c. Follow-on Maintenance
INITIAL SETUP		
<i>Models</i> M1120	<i>References</i> None	
<i>Test Equipment</i> None	<i>Equipment Condition</i> <i>TM or Para</i> <i>Condition Description</i> TM 9-2320-279-10 Engine OFF TM 9-2320-279-10 Wheels chocked TM 9-2320-279-20 Batteries disconnected	
<i>Special Tools</i> Tool Kit, General Mechanic's: Automotive, Item 33, Appendix B	<i>Special Environmental Conditions</i> None	
<i>Supplies</i> None	<i>General Safety Instructions</i> None	
<i>Personnel Required</i> MOS 63S, Heavy wheel vehicle mechanic		

a. Removal.

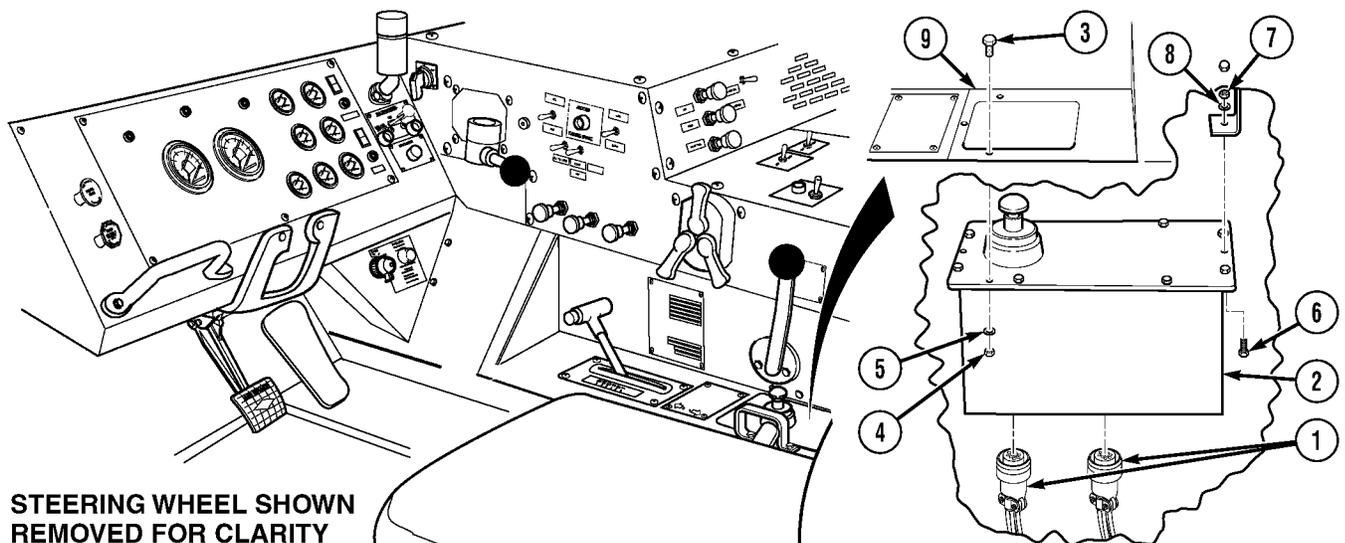

STEERING WHEEL SHOWN REMOVED FOR CLARITY

NOTE

Do not remove eight acorn nuts on distribution box cover. Distribution box is not repairable and should not be disassembled.

- (1) Remove two connectors (1) from distribution box (2).
- (2) Soldier A removes three screws (3), nuts (4), and lockwashers (5) from distribution box (2).
- (3) Soldier B removes screw (6), nut (7) and lockwasher (8) from distribution box (2). Remove distribution box (2) from console (9).

Organizational Maintenance Instructions (Cont)

4-34. LOAD HANDLING SYSTEM (LHS) DISTRIBUTION BOX REPLACEMENT (CONT).

b. Installation.

- (1) Soldier A installs distribution box (1) in console (2).
- (2) Soldier B installs three screws (3), washers (4), and locknuts (5).
- (3) Soldier A installs two connectors (6).

c. Follow-on Maintenance.

- (1) Connect batteries (TM 9-2320-279-20).
- (2) Start engine (TM 9-2320-279-10).
- (3) Check operation of LHS (Para 2-9).
- (4) Shut OFF Engine (TM 9-2320-279-10).
- (5) Remove wheel chocks (TM 9-2320-279-10).

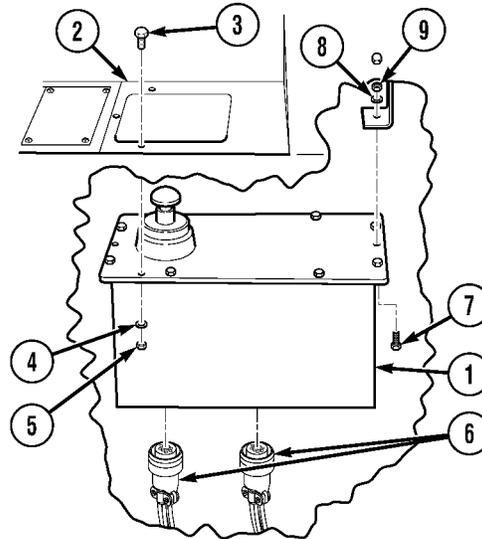

END OF TASK

Organizational Maintenance Instructions (Cont)

4-34.1 CONTAINER HANDLING UNIT (CHU) CONTROL BOX ASSEMBLY REPLACEMENT.		
This task covers:		
a. Removal	b. Installation	c. Follow-on Maintenance
INITIAL SETUP		
<i>Models</i> M1120	<i>References</i> None	
<i>Test Equipment</i> None	<i>Equipment Condition</i> <i>TM or Para</i> <i>Condition Description</i> TM 9-2320-279-10 Engine OFF TM 9-2320-279-10 Wheels chocked TM 9-2320-279-10 Batteries disconnected	
<i>Special Tools</i> Tool Kit, General Mechanic's: Automotive, Item 33, Appendix B	<i>Special Environmental Conditions</i> None	
<i>Supplies</i> Locknut (4), Item 8, Appendix K	<i>General Safety Instructions</i> None	
<i>Personnel Required</i> MOS 63S, Heavy wheel vehicle mechanic		

a. Removal.

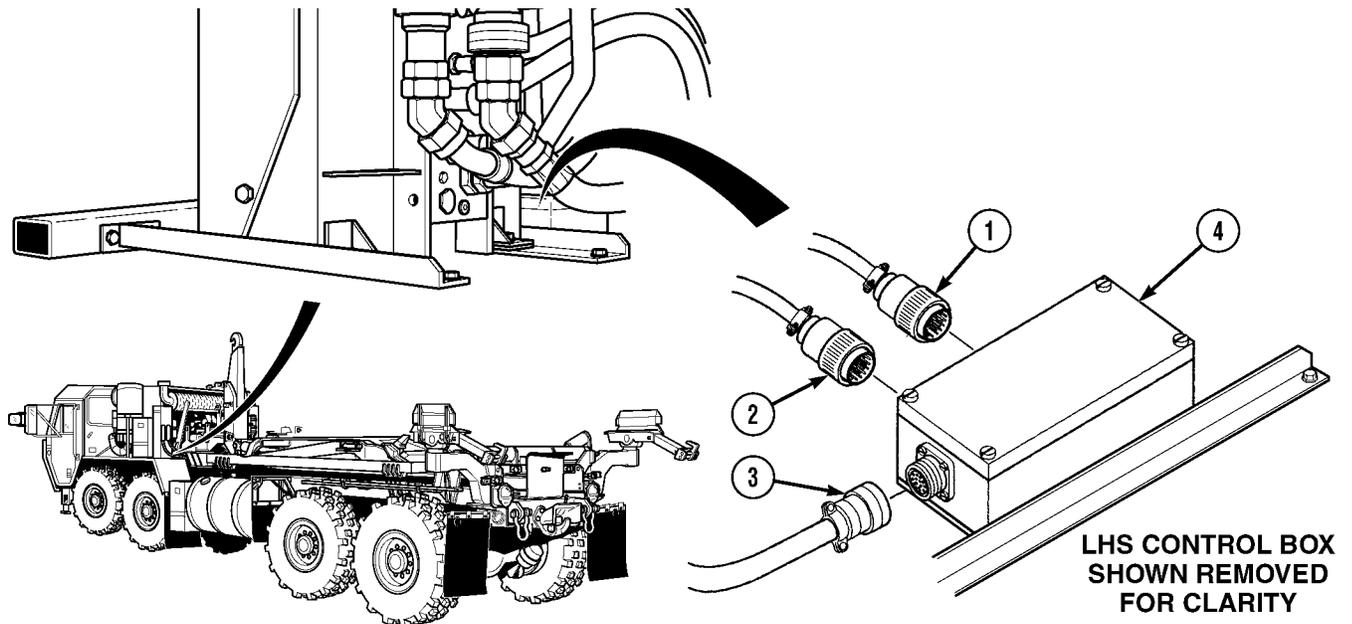

- (1) Disconnect MC185A connector (1), MC82B connector (2), and MC82A connector (3) from CHU control box assembly (4).

Organizational Maintenance Instructions (Cont)

4-34.1 CONTAINER HANDLING UNIT (CHU) CONTROL BOX ASSEMBLY REPLACEMENT (CONT).

- (2) Loosen four screws (5) and remove cover (6) from CHU control box assembly (4).

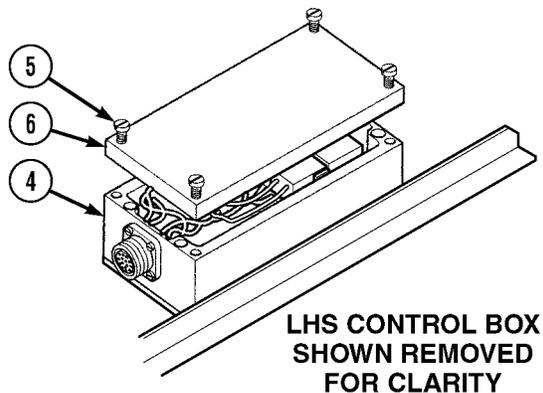

- (3) Remove four screws (7), washers (8), locknuts (9), plate (10), and CHU control box assembly (4) from fender (11). Discard locknuts.

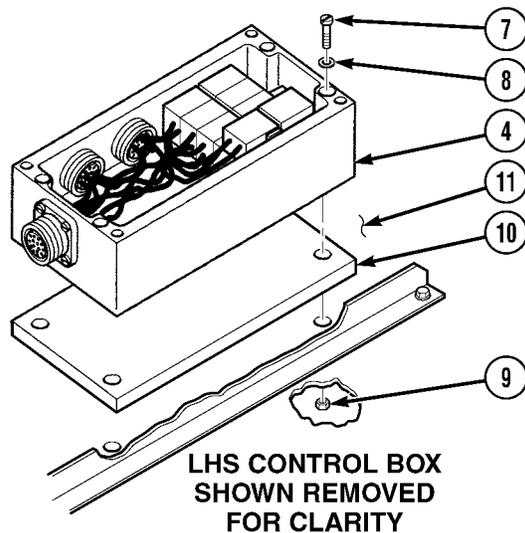

Organizational Maintenance Instructions (Cont)

b. Installation.

NOTE

Move hoses, as required, to position control box and plate.

- (1) Install CHU control box assembly (1) and plate (2) on fender (3) with four screws (4), washers (5), and nuts (6). Tighten nuts.

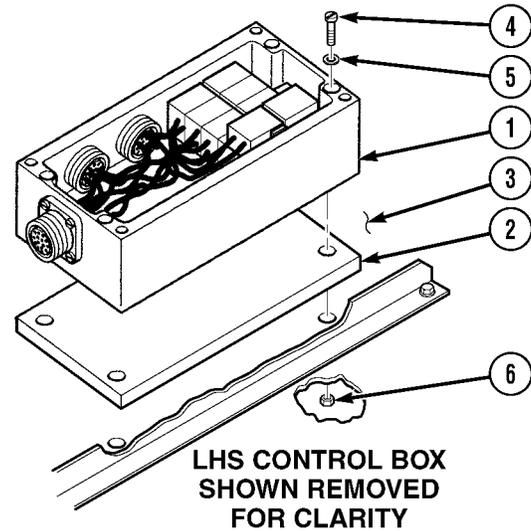

- (2) Install cover (7) on CHU control box assembly (1) with four screws (8). Tighten screws.

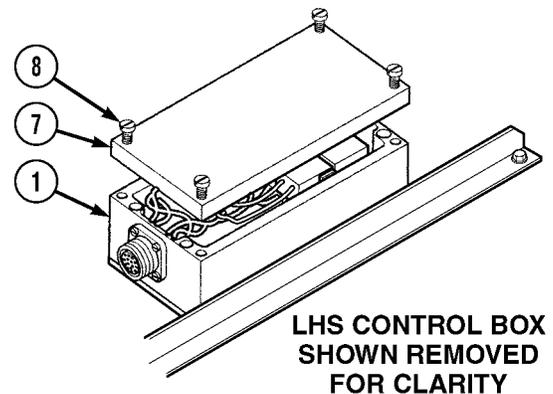

- (3) Connect connector MC185A (9), connector MC82B (10), and connector MC82A (11) on CHU control box assembly (1).

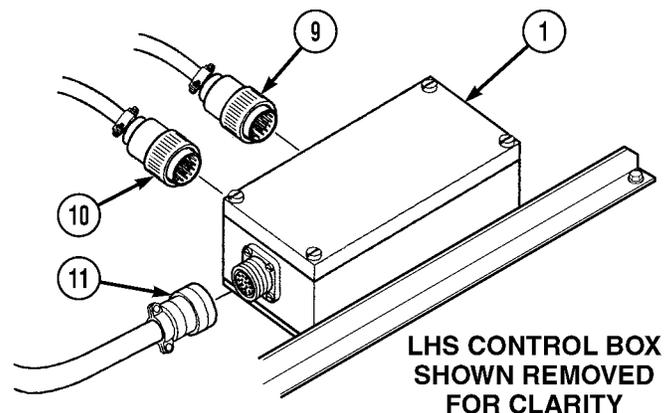

c. Follow-on Maintenance.

- (1) Connect batteries (TM 9-2320-2790-20).
- (2) Remove wheel chocks (TM 9-2320-279-10).

END OF TASK

Organizational Maintenance Instructions (Cont)

4-34.2 CONTAINER HANDLING UNIT (CHU) CONTROL BOX WIRING REPLACEMENT.

This task covers:

- a. Removal
- b. Installation
- c. Follow-on Maintenance

INITIAL SETUP

Models

M1120

References

None

Test Equipment

None

Equipment Condition

<i>TM or Para</i>	<i>Condition Description</i>
TM 9-2320-279-20	Batteries disconnected
TM 9-2320-279-10	Wheels chocked
Para 4-34.1	CHU control box assembly removed

Special Tools

Tool Kit, General Mechanic's Automotive, Item 33, Appendix B

Supplies

Tags, Identification, Item 19, Appendix F

Special Environmental Conditions

None

Personnel Required

MOS 63S, Heavy wheel vehicle mechanic

General Safety Instructions

None

Organizational Maintenance Instructions (Cont)

a. Removal.

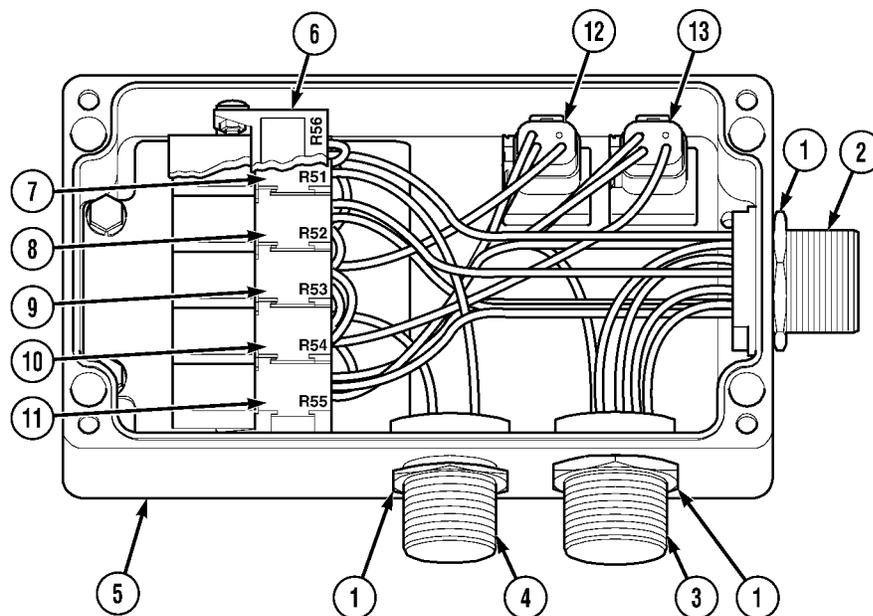

NOTE

This procedure shows removal of CHU wiring for CHU control box. Only remove wiring required to complete task.

- (1) Remove three nuts (1) from connectors MC82A (2), MC82B (3), and MC185A (4) on control box (5).

NOTE

- Disconnect only wires required to complete task. Refer to Table 4-4.1, CHU Control Box Wiring, for specific control box wiring replacement.
- Tag and mark wires prior to removal.

Table 4-4.1 CHU Control Box Wiring

Cable No.	Color	From	To
1435	BLK	10 Pin Connector A (MC185A) (4)	17 Pin Connector K (MC82A) (2) 17 Pin Connector K (MC82B) (3)
1474	BLK	10 Pin Connector B (MC185A) (4)	17 Pin Connector F (MC82A) (2) 17 Pin Connector F (MC82B) (3) Relay R54/Terminal 3 (10)
1466B	BLK	10 Pin Connector C (MC185A) (4)	Relay R53/Terminal 3 (9)
1466C	BLK	Relay R53/Terminal 4	Relay R54/Terminal 1 (13)
1495	BLK	10 Pin Connector D (MC185A) (4)	
1435	BLK	10 Pin Connector E (MC185A) (4)	

Organizational Maintenance Instructions (Cont)

4-34.2 CONTAINER HANDLING UNIT (CHU) CONTROL BOX WIRING REPLACEMENT (CONT).

Table 4-4.1 CHU Control Box Wiring (cont)

Cable No.	Color	From	To
1495	BLK	10 Pin Connector F (MC185A) (4)	Relay R55/Terminal 2 (11) 17 Pin Connector K (MC82B) (3)
1496	BLK	10 Pin Connector G (MC185A) (4)	Relay R51/Terminal 2 (7)
1469A	BLK	10 Pin Connector J (MC185A) (4)	Relay R53/Terminal 1 (9)
1465	BLK	17 Pin Connector A (MC82A) (2)	17 Pin Connector A (MC82B) (3) Relay R52/Terminal 1 (8)
1467	BLK	17 Pin Connector B (MC82A) (2)	17 Pin Connector B (MC82B) (3) Relay R56/Terminal 3 (6)
1468A	BLK	Relay R55/Terminal 4 (11)	17 Pin Connector C (MC82B) (3)
1468	BLK	17 Pin Connector C (MC82A) (2)	Relay R55/Terminal 3 (11)
1464	BLK	17 Pin Connector D (MC82A) (2)	Relay R52/Terminal 3 (8)
1466	BLK	17 Pin Connector E (MC82A) (2)	Diode M101/Terminal 4 (12)
1466D	BLK	Diode M101/Terminal 3 (12)	17 Pin Connector E (MC82B) (3)
1472	BLK	17 Pin Connector F (MC82A) (2)	10 Pin Connector B (MC185A) (4) 17 Pin Connector F (MC82B) (3) Relay R54/Terminal 3 (10)
1469	BLK	17 Pin Connector G (MC82A) (2)	Diode M100/Terminal 4 (13)
1469D	BLK	Diode M100/Terminal 3 (13)	17 Pin Connector G (MC82B) (3)
1463	BLK	17 Pin Connector H (MC82A) (2)	17 Pin Connector H (MC82B) (3)
1462	BLK	17 Pin Connector J (MC82A) (2)	17 Pin Connector J (MC82B) (3)
1435	BLK	17 Pin Connector K (MC82A) (2)	17 Pin Connector K (MC82B) (3) 10 Pin Connector A & F (MC185A) (4) Relay R55/Terminal 2 (11)
1435	BLK	17 Pin Connector L (MC82A) (2)	17 Pin Connector L (MC82B) (3)
1471	BLK	17 Pin Connector M (MC82A) (2)	17 Pin Connector M (MC82B) (3)
1460	BLK	17 Pin Connector N (MC82A) (2)	17 Pin Connector N (MC82B) (3)
1459	BLK	17 Pin Connector P (MC82A) (2)	17 Pin Connector P (MC82B) (3)
1435	BLK	17 Pin Connector R (MC82A) (2)	17 Pin Connector R (MC82B) (3)
1435	BLK	17 Pin Connector S (MC82A) (2)	17 Pin Connector S (MC82B) (3)
1465	BLK	17 Pin Connector A (MC82B) (3)	17 Pin Connector A (MC82A) (2) Relay R52/Terminal 1 (8)
1467	BLK	17 Pin Connector B (MC82B) (3)	17 Pin Connector B (MC82A) (2) Relay R56/Terminal 3 (6)
1468A	BLK	17 Pin Connector C (MC82B) (3)	Relay R55/Terminal 4 (11)
1468	BLK	Relay R55/Terminal 3 (11)	17 Pin Connector C (MC82A) (2)
1464B	BLK	17 Pin Connector D (MC82B) (3)	Relay R51/Terminal 4 (7)

Organizational Maintenance Instructions (Cont)

Table 4-4.1 CHU Control Box Wiring (cont)

Cable No.	Color	From	To
1464	BLK	Relay R52/Terminal 3 (8)	17 Pin Connector D (MC82A) (2)
1466D	BLK	17 Pin Connector E (MC82B) (3)	Diode M101/Terminal 3 (12)
1466	BLK	Diode M101/Terminal 4 (12)	17 Pin Connector E (MC82A) (2)
1472	BLK	17 Pin Connector F (MC82B) (3)	10 Pin Connector B (MC185A) (4) 17 Pin Connector F (MC82A) (2) Relay R54/Terminal 3 (10)
1469D	BLK	17 Pin Connector G (MC82B) (3)	Diode M100/Terminal 3 (13)
1469	BLK	Diode M100/Terminal 4 (13)	17 Pin Connector G (MC82A) (2)
1463	BLK	17 Pin Connector H (MC82B) (3)	17 Pin Connector H (MC82A) (2)
1462	BLK	17 Pin Connector J (MC82B) (3)	17 Pin Connector J (MC82A) (2)
1435	BLK	17 Pin Connector K (MC82B) (3)	17 Pin Connector K (MC82A) (2) 10 Pin Connector A (MC185A) (4)
1435	BLK	17 Pin Connector L (MC82B) (3)	17 Pin Connector L (MC82A) (2)
1471	BLK	17 Pin Connector M (MC82B) (3)	17 Pin Connector M (MC82A) (2)
1460	BLK	17 Pin Connector N (MC82B) (3)	17 Pin Connector N (MC82A) (2)
1459	BLK	17 Pin Connector P (MC82B) (3)	17 Pin Connector P (MC82A) (2)
1435	BLK	17 Pin Connector R (MC82B) (3)	17 Pin Connector R (MC82A) (2)
1435	BLK	17 Pin Connector S (MC82B) (3)	17 Pin Connector S (MC82A) (2)
1435	BLK	Relay R52/Terminal 2 (8)	Relay R53/Terminal 2 (9)
1464A	BLK	Relay R52/Terminal 4 (8)	Relay R51/Terminal 3 (7)
	BLK	Relay R51/Terminal 1 (7)	Relay R51/Terminal 3 (7)
1464A	BLK	Relay R51/Terminal 3 (7)	Relay R52/Terminal 4 (8)
1464B	BLK	Relay R51/Terminal 4 (7)	17 Pin Connector D (MC82B) (3)
1435	BLK	Relay R56/Terminal 2 (6)	Relay 52/Terminal 2 (8)
1469E	BLK	Relay R56/Terminal 1 (6)	Diode M100/Terminal 1 (13)
1467A	BLK	Relay R56/Terminal 5 (6)	Relay 55/Terminal 1 (11)
1467	BLK	Relay R56/Terminal 3 (6)	17 Pin Connector B (MC82B) (3) 17 Pin Connector B (MC82A) (2)
1466C	BLK	Relay R53/Terminal 4 (9)	Relay R54/Terminal 1 (10)
1466B	BLK	Relay R53/Terminal 3 (9)	10 Pin Connector C (MC185A) (4)
	BLK	Relay R53/Terminal 2 (9)	Relay R54/Terminal 2 (10)
1435	BLK	Relay R54/Terminal 2 (10)	Relay R55/Terminal 2 (11)
1469B	BLK	Relay R54/Terminal 5 (10)	Diode M100/Terminal 2 (13)
1468A	BLK	Relay R55/Terminal 4 (11)	17 Pin Connector C (MC82B) (3)
1495	BLK	Relay R55/Terminal 2 (11)	10 Pin Connector F (MC185A) (4)
1467	BLK	Relay R56/Terminal 3 (6)	17 Pin Connector B (MC82B) (3) 17 Pin Connector B (MC82A) (2)

Organizational Maintenance Instructions (Cont)

4-34.2 CONTAINER HANDLING UNIT (CHU) CONTROL BOX WIRING REPLACEMENT (CONT).

b. Installation.

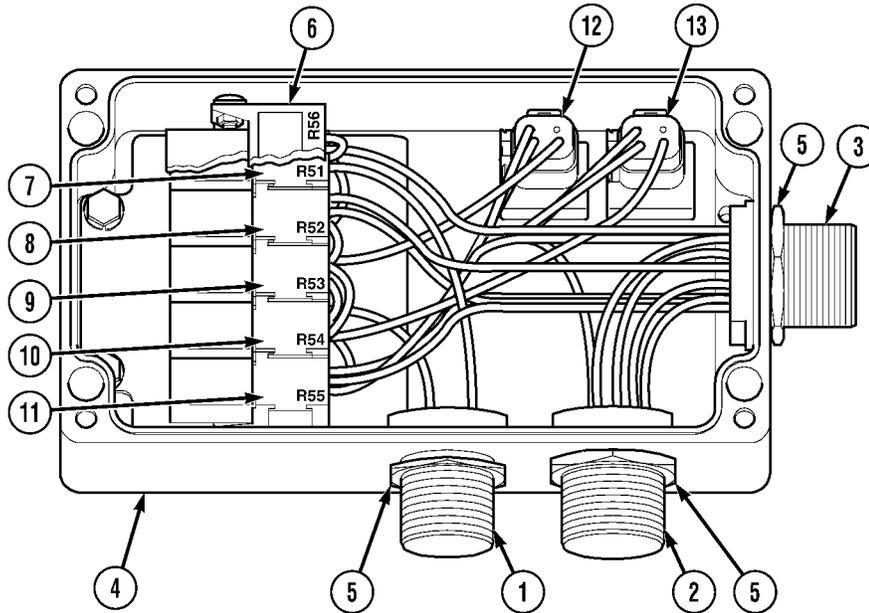

NOTE

Connect only wires required to complete task. Refer to Table 4-4.1, CHU Control Box Wiring, for specific control box wiring replacement.

- (1) Follow Table 4-4.1 and removal illustration to connect wires.
- (2) Install connectors MC185A (1), MC82B (2), and MC82A (3) to control box (4) using three nuts (5).

c. Follow-on Maintenance.

- (1) Install CHU control box assembly (Para 4-34.1).
- (2) Connect batteries (TM 9-2320-279-20).
- (3) Remove wheel chocks (TM 9-2320-279-10).

END OF TASK

Organizational Maintenance Instructions (Cont)

4-34.3 CONTAINER HANDLING UNIT (CHU) CONTROL BOX REPAIR (CONT).

- (3) Remove locking nut (9), relay socket module (2), and screw (10). Discard locking nut.
- (4) Remove two screws (11), lockwashers (12), and relay mount bracket (13) from control box (14). Discard lockwashers.
- (5) Remove two screws (15), bracket (16), and five relay socket modules (8) from relay mount bracket (13). Discard lockwashers.

NOTE

Perform step (6) if inserts are damaged.

- (6) Remove two inserts (17) from relay mount bracket (13).

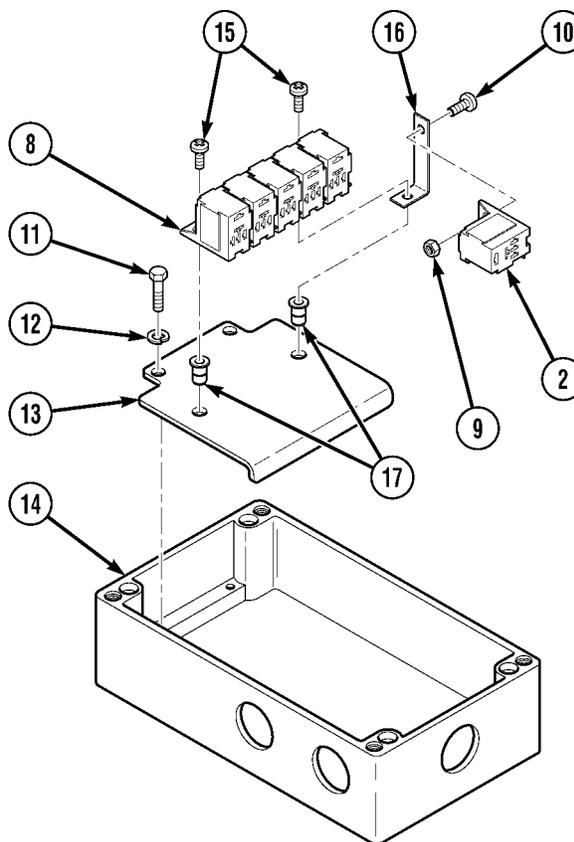

Organizational Maintenance Instructions (Cont)

b. Assembly.

NOTE

Perform step (1) if inserts were removed.

- (1) Install two inserts (1) in relay mount bracket (2).
- (2) Install five socket modules (3), one bracket (4), and two screws (5) to relay mount bracket (2).
- (3) Install relay mount bracket (2), two lockwashers (6), and screws (7) to control box (8).
- (4) Install relay socket module (9) with screw (10) and locking nut (11).

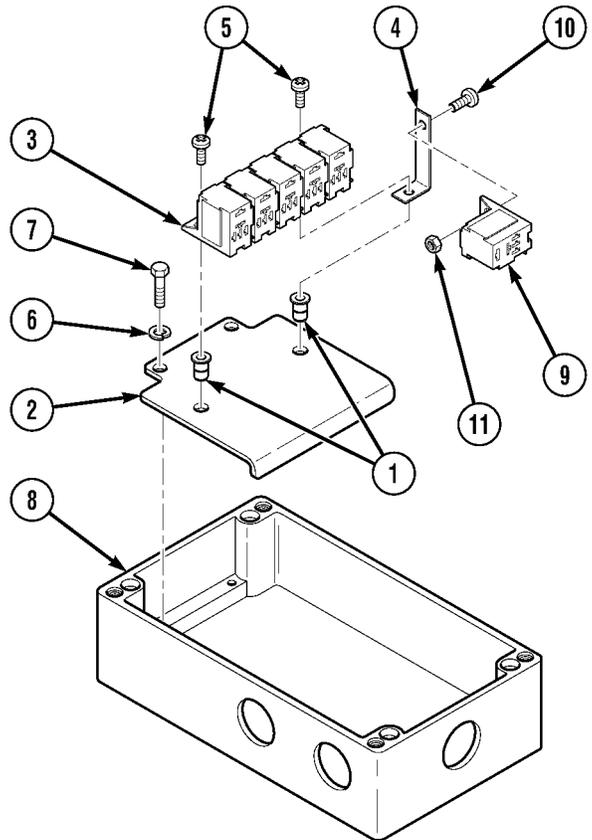

- (5) Install relays R51 (12), R52 (13), R53 (14), R54 (15), R55 (16) to five relay socket modules (3).
- (6) Install relay R56 (17) to relay socket module (9).

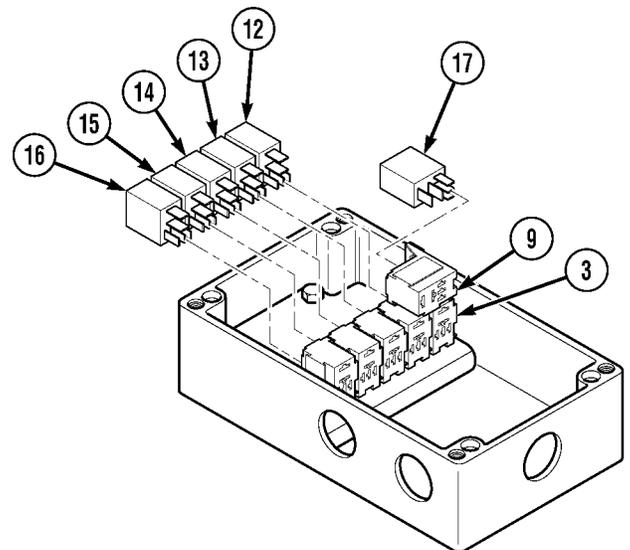

c. Follow-on Maintenance. Install CHU box wiring (Para 4-34.2).

END OF TASK

Organizational Maintenance Instructions (Cont)

4-35. PROXIMITY SWITCH REPLACEMENT/ADJUSTMENT (HOOK ARM DOWN).

This task covers:

- | | |
|-----------------|--------------------------|
| a. Removal | c. Adjustment |
| b. Installation | d. Follow-on Maintenance |

INITIAL SETUP

Models

M1120

Test Equipment

None

Special Tools

Tool Kit, General Mechanic's: Automotive, Item 33, Appendix B
 Gage, Feeler, Item 9, Appendix B
 Wrench, Combination, 1 1/2 in., Item 39, Appendix B

Supplies

Tags, Identification, Item 19, Appendix F

Personnel Required

MOS 63S, Heavy wheel vehicle mechanic

References

TM 43-0158

Equipment Condition

<i>TM or Para</i>	<i>Condition Description</i>
Para 2-9	LHS in transit position
TM 9-2320-279-10	Engine OFF
TM 9-2320-279-10	Wheels chocked
TM 9-2320-279-20	Batteries disconnected

Special Environmental Conditions

None

General Safety Instructions

None

a. Removal.

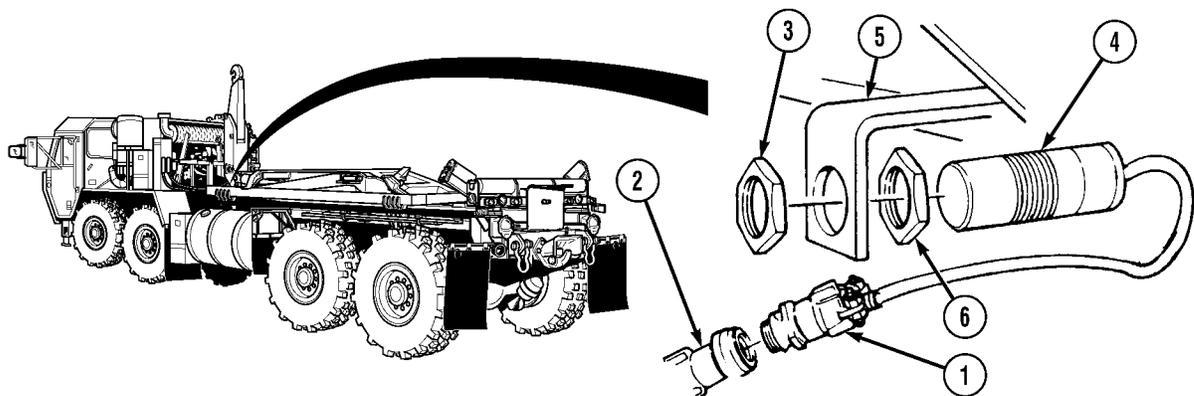

- (1) Disconnect proximity switch MC88 connector (1) from main harness connector (2).
- (2) Remove nut (3) and proximity switch (4) from compression frame (5).
- (3) Remove nut (6) from proximity switch (4).

Organizational Maintenance Instructions (Cont)

4-35. PROXIMITY SWITCH REPLACEMENT/ADJUSTMENT (HOOK ARM DOWN) (CONT).

NOTE

Tag all wires prior to removal.

- (4) Loosen two screws (7) and remove nut (8) from MC88 connector (1).
- (5) Remove three wires (9) with terminals (10) from MC88 connector (1).
- (6) Remove nut (8) and MC 88 connector (1) from proximity switch (4).

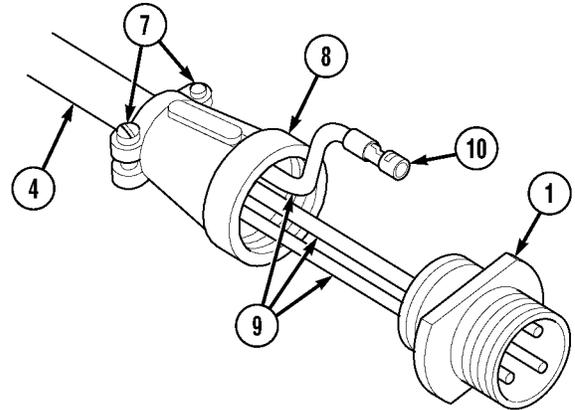

b. Installation.

- (1) Position nut (1) and MC88 connector (2) on proximity switch (3).
- (2) Install three terminals (4) with wires (5) in MC88 connector (2) in the following positions:

Wire	Position	Color
1472	A	Brown
1471	B	Black
1435	C	Blue

Table 4-5. Proximity Switch Wire Positions

- (3) Install nut (1) on MC88 connector (2) and tighten two screws (6).

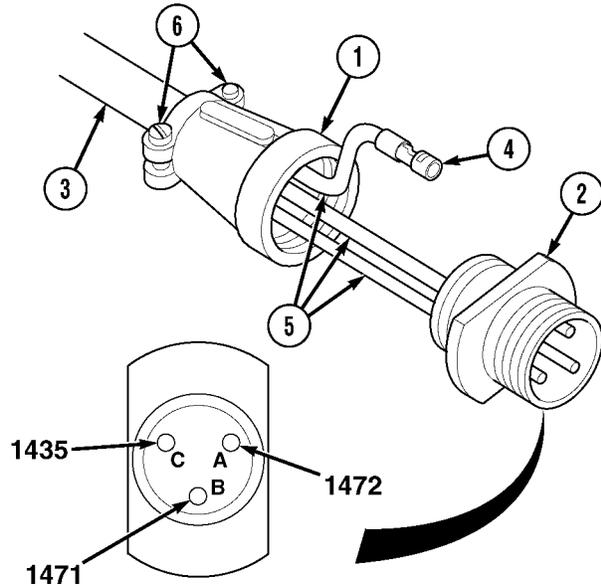

NOTE

Serrated side of nuts face bracket.

- (4) Install nut (7) on proximity switch (3).
- (5) Install proximity switch (3) and nut (8) on compression frame (9).
- (6) Install proximity switch MC88 connector (2) on main harness connector (10).

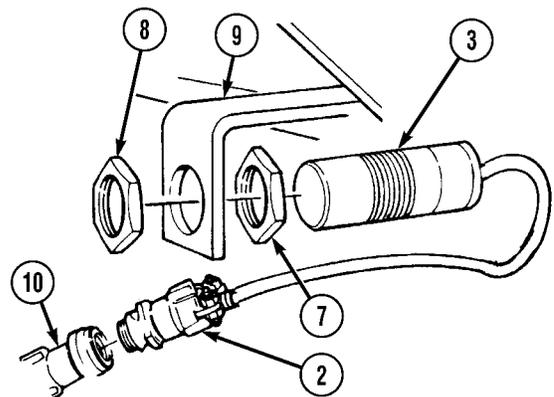

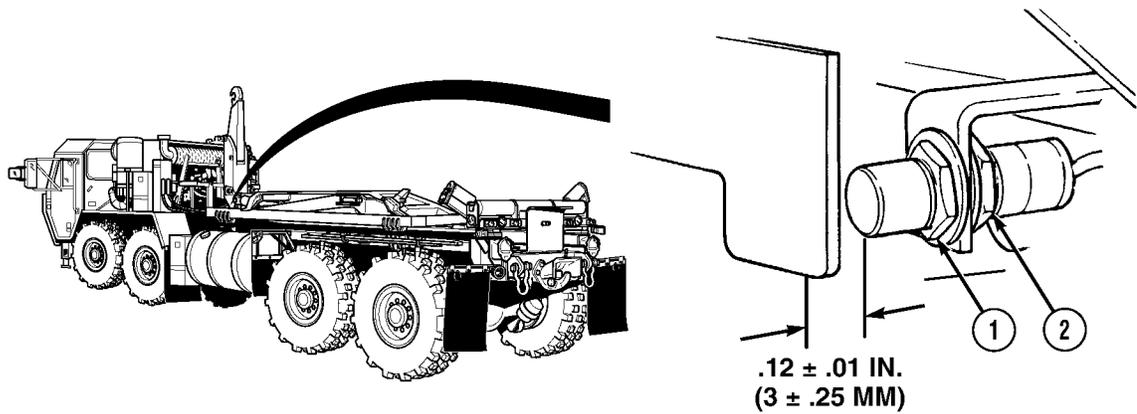
Organizational Maintenance Instructions (Cont)

c. Adjustment. Using feeler gage, adjust clearance between proximity switch and hook arm to 0.12 ± 0.01 in. (3 ± 0.25 mm) and tighten nuts (1 and 2).

d. Follow-on Maintenance.

- (1) Connect batteries (TM 9-2320-279-20).
- (2) Check operation of hook arm (Para 2-9).
- (3) Remove wheel chocks (TM 9-2320-279-10).

END OF TASK

Organizational Maintenance Instructions (Cont)

4-36. PROXIMITY SWITCH REPLACEMENT/ADJUSTMENT (HOOK ARM UP).	
This task covers:	
a. Removal	c. Adjustment
b. Installation	d. Follow-on Maintenance
INITIAL SETUP	
<i>Models</i> M1120	<i>References</i> TM 43-0158
<i>Test Equipment</i> None	<i>Equipment Condition</i>
<i>Special Tools</i> Tool Kit, General Mechanic's: Automotive, Item 33, Appendix B	<i>TM or Para</i> <i>Condition Description</i>
<i>Supplies</i> Tags, Identification, Item 19, Appendix F Cable ties, Item 4, Appendix F	Para 2-9 LHS in transit position
<i>Personnel Required</i> MOS 63S, Heavy wheel vehicle mechanic	TM 9-2320-279-10 Engine OFF
	TM 9-2320-279-10 Wheels chocked
	TM 9-2320-279-20 Batteries disconnected
	<i>Special Environmental Conditions</i> None
	<i>General Safety Instructions</i> None

a. Removal.

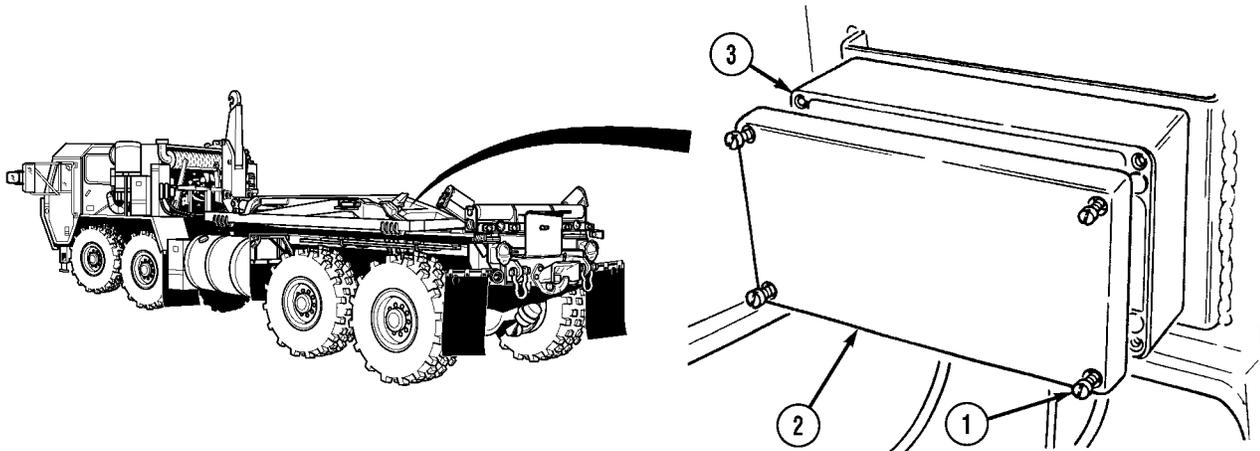

(1) Loosen four captive screws (1) and junction box cover (2) from junction box (3).

Organizational Maintenance Instructions (Cont)

NOTE

- Tag and mark wires prior to removal.
 - Remove cable ties as required.
- (2) Remove wire 1435 (4) from terminal (5), wire 1474 (6) from terminal (7), and wire 1466 (8) from terminal (9).
 - (3) Remove collar (10), washer (11), sealing ring (12), and wires 1435 (4), 1474 (6), and 1466 (8) from junction box (3).

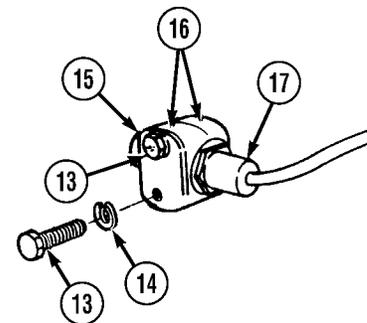
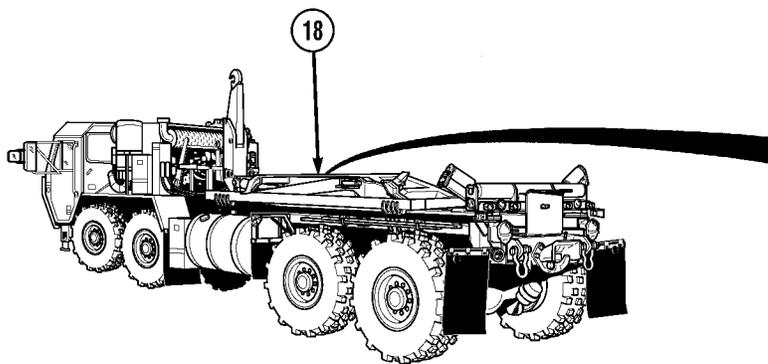
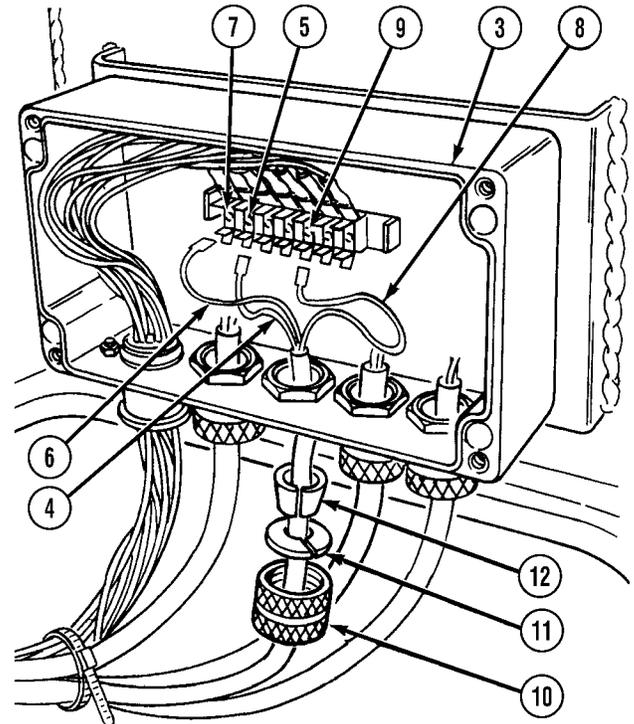

- (4) Remove two screws (13), lockwashers (14), and coverplate (15) from two clamp halves (16). Discard lockwashers.
- (5) Remove two clamp halves (16) with proximity switch (17) as an assembly from main frame (18).

Organizational Maintenance Instructions (Cont)

4-36. PROXIMITY SWITCH REPLACEMENT/ADJUSTMENT (HOOK ARM UP) (CONT).

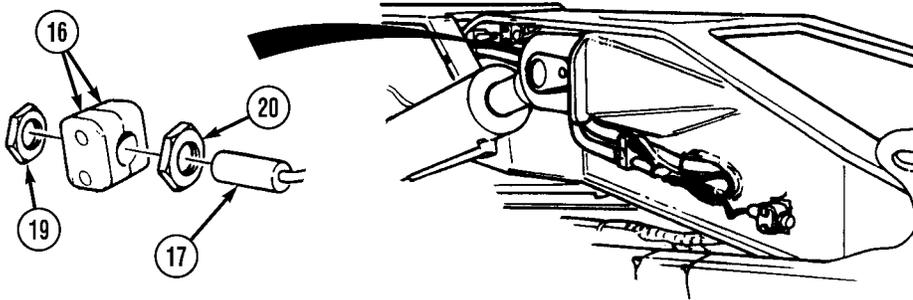

(6) Remove nut (19), two clamp halves (16), and nut (20) from proximity switch (17).

b. Installation.

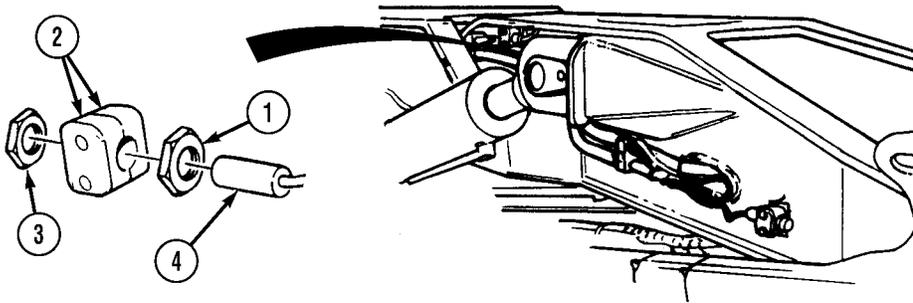

NOTE

Serrated side of nuts face clamp.

(1) Install nut (1), two clamp halves (2), and nut (3) on proximity switch (4).

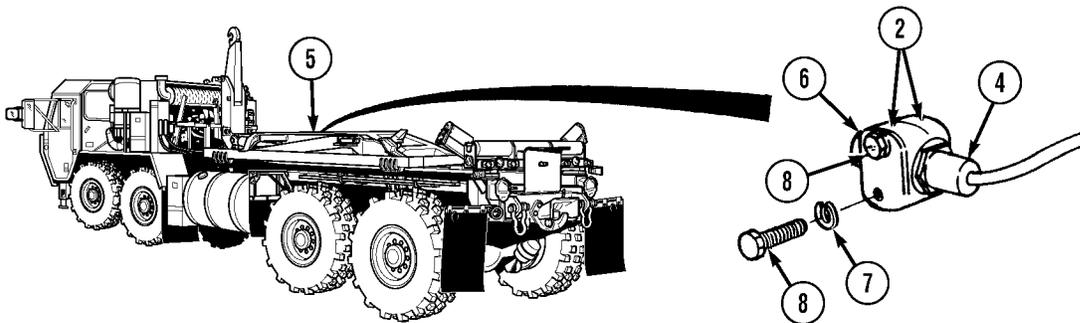

(2) Position proximity switch (4) with two clamp halves (2) as an assembly on main frame (5) with coverplate (6), two lockwashers (7), and screws (8).

Organizational Maintenance Instructions (Cont)

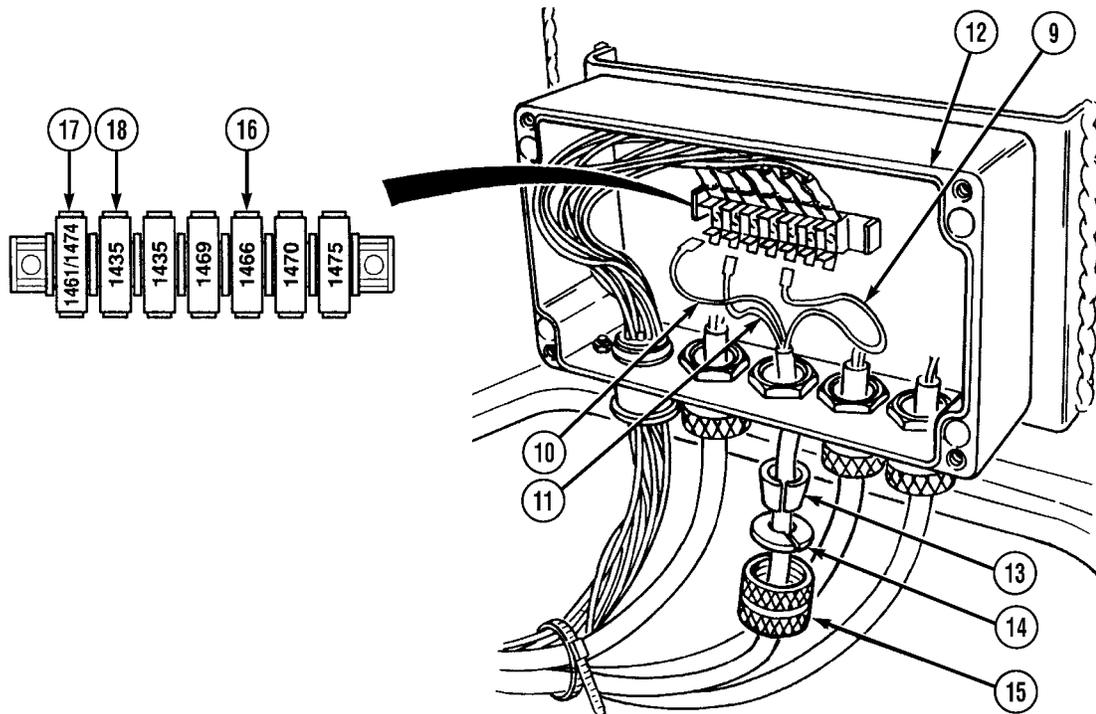

NOTE

Wire numbers on harnesses are positioned on terminal strip as indicated in chart.

- (3) Install wires 1466 (9), 1474 (10), and 1435 (11) in junction box (12) with sealing ring (13), washer (14), and collar (15).
- (4) Install wire 1466 (9) on terminal (16), wire 1474 (10) on terminal (17), and wire 1435 (11) on terminal (18).
- (5) Install junction box cover (19) on junction box (12) and tighten four screws (20).

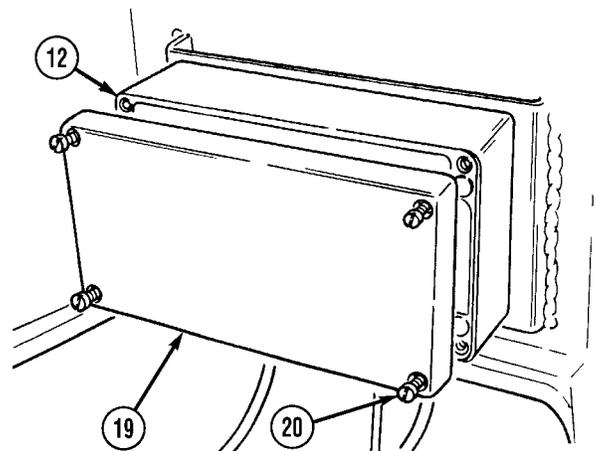

Organizational Maintenance Instructions (Cont)

4-36. PROXIMITY SWITCH REPLACEMENT/ADJUSTMENT (HOOK ARM UP) (CONT).

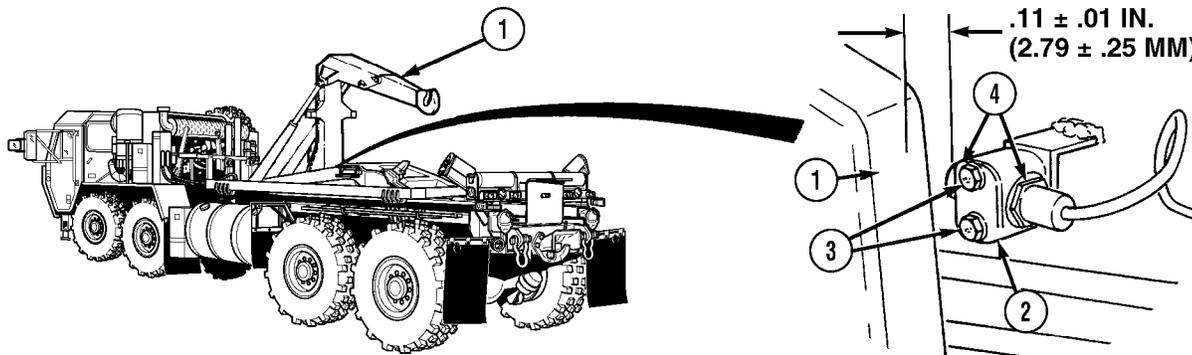

c. Adjustment.

- (1) Connect batteries (TM 9-2320-279-20).
- (2) Fully extend hook arm (1) using manual mode only (Para 2-9).
- (3) Adjust clearance between proximity switch (2) and hook arm (1) using two screws (3) and nuts (4). Clearance should be 0.11 in. ± 0.01 in. (2.79 mm ± 0.25 mm).
- (4) Tighten two captive screws (3) on proximity switch (2).
- (5) Tighten front nut (4).

d. Follow-on Maintenance.

- (1) Check LHS operation (Para 2-9).
- (2) LHS in transit position (Para 2-9).
- (3) Remove wheel chocks (TM 9-2320-279-10).

END OF TASK

Organizational Maintenance Instructions (Cont)

4-37. PROXIMITY SWITCH REPLACEMENT/ADJUSTMENT (MAIN FRAME DOWN).

This task covers:

- a. Removal
- b. Installation
- c. Adjustment
- d. Follow-on Maintenance

INITIAL SETUP

Models

M1120

References

TM 43-0158

Test Equipment

None

Equipment Condition

<i>TM or Para</i>	<i>Condition Description</i>
Para 2-9	LHS in transit position
TM 9-2320-279-10	Engine OFF
TM 9-2320-279-10	Wheels chocked
TM 9-2320-279-20	Batteries disconnected

Special Tools

Tool Kit, General Mechanic's: Automotive, Item 33, Appendix B

Special Environmental Conditions

None

Supplies

- Cable Ties, Item 4, Appendix F
- Tags, Identification, Item 19, Appendix F
- Locknut (2), Item 8, Appendix K
- Lockwasher (2), Item 18, Appendix K
- Lockwasher (2), Item 22, Appendix K

General Safety Instructions

None

Personnel Required

MOS 63S, Heavy wheel vehicle mechanic

a. Removal.

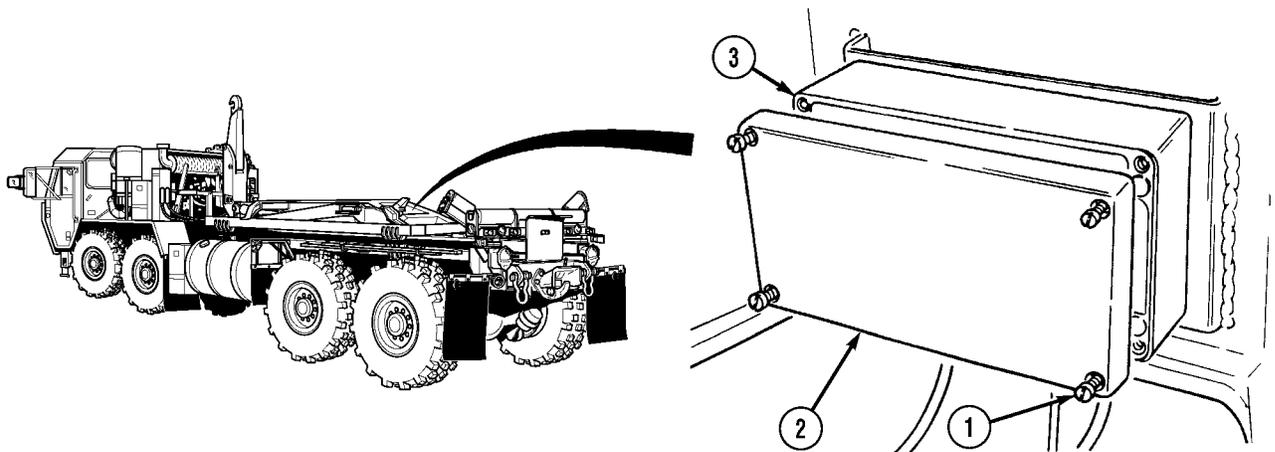

(1) Loosen four captive screws (1) and junction box cover (2) from junction box (3).

Organizational Maintenance Instructions (Cont)

**4-37. PROXIMITY SWITCH REPLACEMENT/ADJUSTMENT (MAIN FRAME DOWN)
(CONT).**

NOTE

- Tag and mark wires prior to removal.
 - Remove cable ties as required.
- (2) Remove wire 1435 (4) from terminal (5), wire 1469 (6) from terminal (7), and wire 1461 (8) from terminal (9).
 - (3) Remove collar (10), washer (11), sealing ring (12), and wires 1435 (4), 1469 (6), and 1461 (8) from junction box (3).

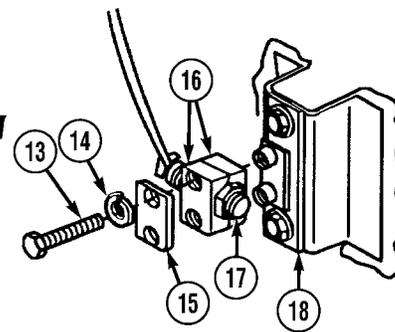
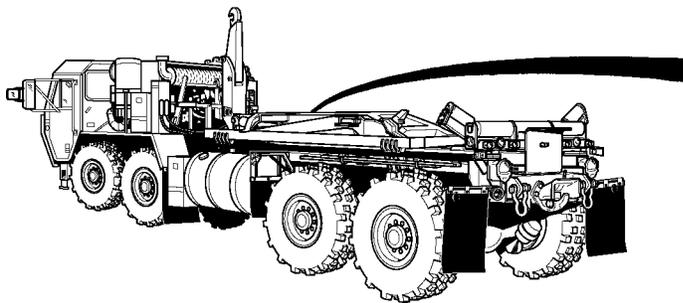
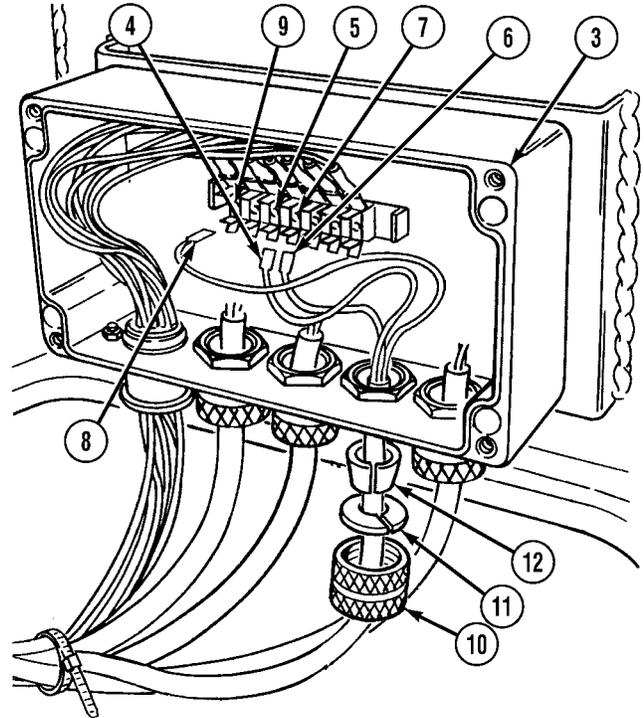

- (4) Remove two screws (13), lockwashers (14), and coverplate (15) from two clamp halves (16). Discard lockwashers.
- (5) Remove two clamp halves (16) with proximity switch (17) as an assembly from proximity switch mounting plate (18).

Organizational Maintenance Instructions (Cont)

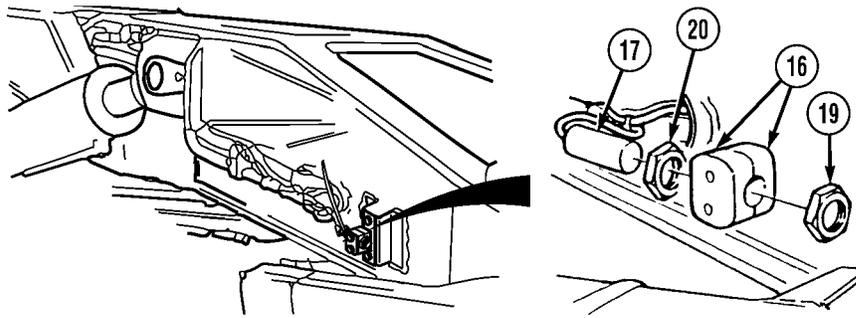

- (6) Remove nut (19), two clamp halves (16), and nut (20) from proximity switch (17). Discard lockwashers.

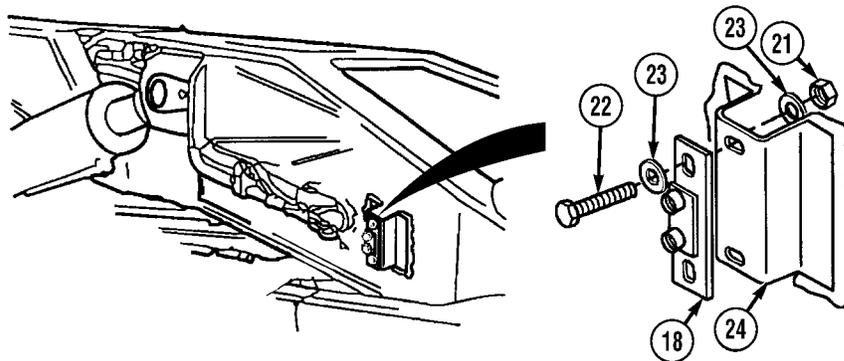

- (7) Remove two locknuts (21), screws (22), four washers (23), and proximity switch mounting plate (18) from main frame (24).

b. Installation.

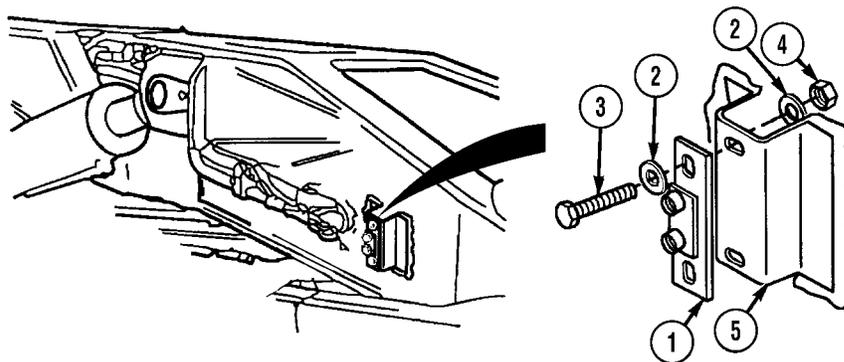

NOTE

Install cable ties as required.

- (1) Position proximity switch mounting plate (1), four washers (2), two screws (3), and locknuts (4) on main frame (5).

Organizational Maintenance Instructions (Cont)

**4-37. PROXIMITY SWITCH REPLACEMENT/ADJUSTMENT (MAIN FRAME DOWN)
(CONT).**

NOTE

Serrated side of nuts face clamp.

- (2) Position nut (6), two clamp halves (7), and nut (8) on proximity switch (9).

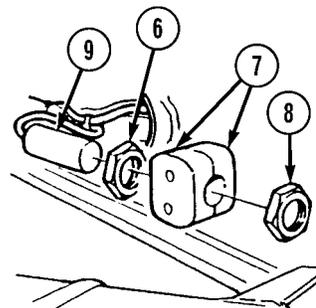

- (3) Position proximity switch (9) with two clamp halves (7) as an assembly on proximity switch mounting plate (10) with coverplate (11), two lockwashers (12), and screws (13).

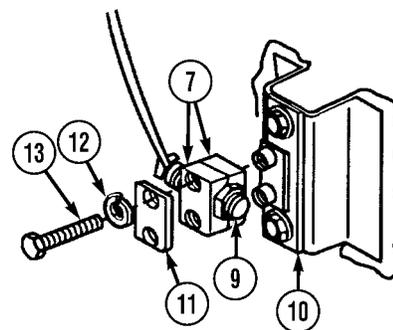

Organizational Maintenance Instructions (Cont)

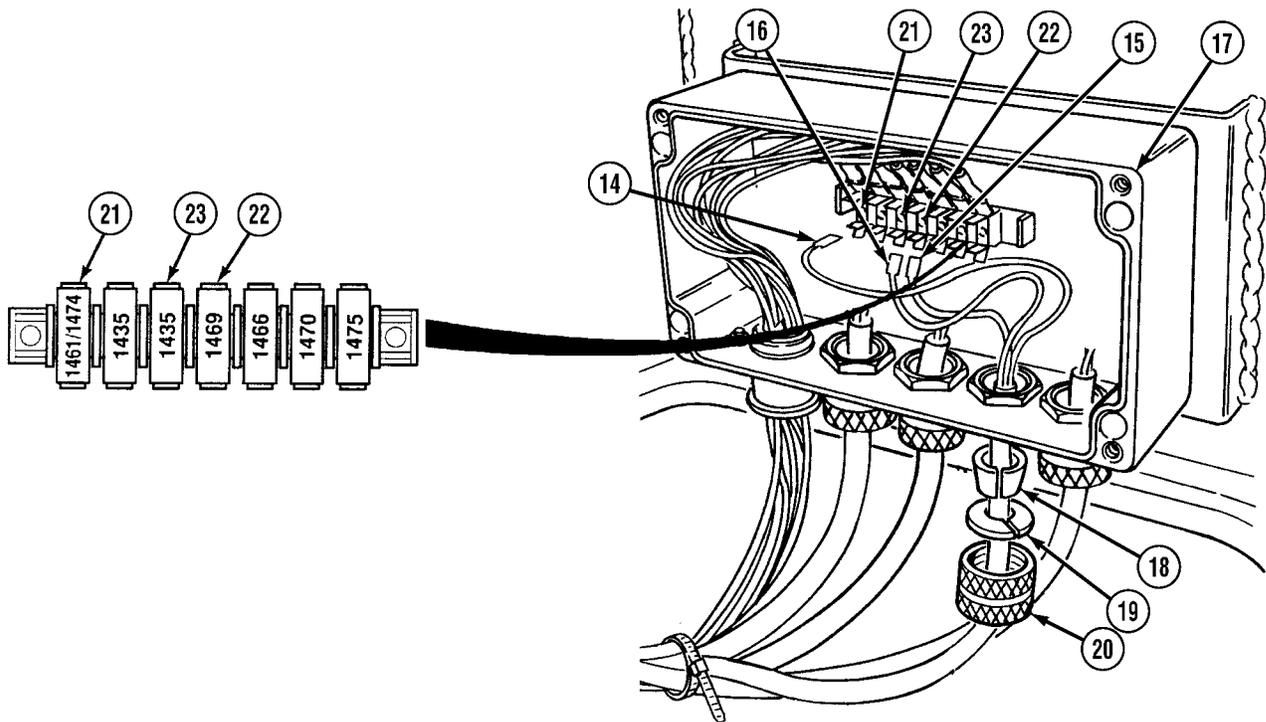
**NOTE**

Wire numbers on harnesses are positioned on terminal strip as indicated in chart.

- (4) Install wires 1461 (14), 1469 (15 and 16) in junction box (17) with sealing ring (18), washer (19), and collar (20).
- (5) Install wire 1461 (14) on terminal (21), wire 1469 (15) on terminal (22), and wire 1435 (16) on terminal (23).

Organizational Maintenance Instructions (Cont)

4-37. PROXIMITY SWITCH REPLACEMENT/ADJUSTMENT (MAIN FRAME DOWN) (CONT).

- (6) Position junction box cover (24) on junction box (17) and tighten four captive screws (25).

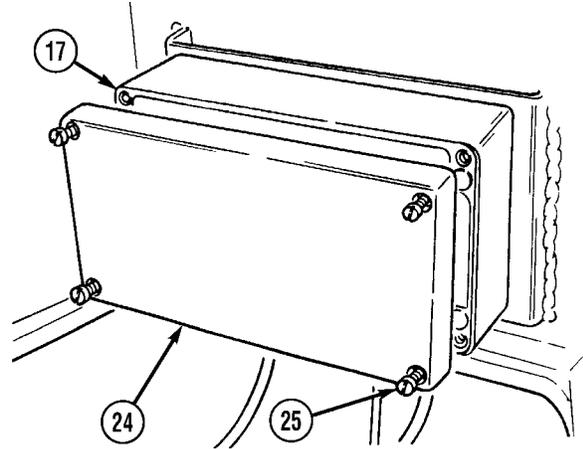

c. Adjustment.

NOTE

Proximity switch mounting plate and main frame have slotted holes to aid in adjustment.

- (1) Adjust height between top of proximity switch (1) and top of target plate (2). Height should be $3/8 \text{ in.} \pm 3/32 \text{ in.}$ ($9.65 \text{ mm} \pm 0.25 \text{ mm}$).
- (2) Tighten proximity switch mounting plate (3) with two screws (4) and locknuts (5).
- (3) Adjust clearance between proximity switch (1) and target plate (2), using nuts (6). Clearance should be $0.125 \text{ in.} \pm 0.01 \text{ in.}$ ($3.175 \text{ mm} \pm 0.25 \text{ mm}$).
- (4) Tighten two screws (7) on clamp halves (8).

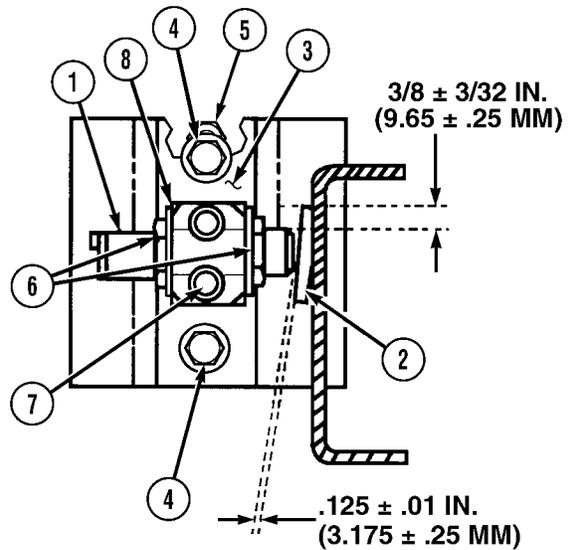

d. Follow-on Maintenance.

- (1) Connect batteries (TM 9-2320-279-20).
- (2) Check LHS operation (Para 2-9).
- (3) Remove wheel chocks (TM 9-2320-279-10).

END OF TASK

Organizational Maintenance Instructions (Cont)

4-37.1 CONTAINER HANDLING UNIT (CHU) PROXIMITY SWITCH AND SENSING PLATE REPLACEMENT/ADJUSTMENT (HOOK ARM UP).

This task covers:

- a. Removal
- b. Installation
- c. Adjustment
- d. Follow-on Maintenance

INITIAL SETUP

Models

M1120

Personnel Required

MOS 63S, Heavy wheel vehicle mechanic

Test Equipment

None

References

None

Special Tools

Tool Kit, General Mechanic's Automotive, Item 33, Appendix B
 Clamp, Machinist's (2), Item 2.1, Appendix B
 Gage, Feeler, Item 9, Appendix B
 Goggles, Industrial, Item 12, Appendix B
 Epoxy, Item 7.2, Appendix F

Equipment Condition

<i>TM or Para</i>	<i>Condition Description</i>
Para 2-10.11	FLA removed
TM 9-2320-279-10	Engine OFF
TM 9-2320-279-10	Wheels chocked
TM 9-2320-279-20	Batteries disconnected

Special Environmental Conditions

None

Supplies

Tags, Identification, Item 19, Appendix F
 Lockwasher (2), Item 20, Appendix K

General Safety Instructions

None

a. Removal.

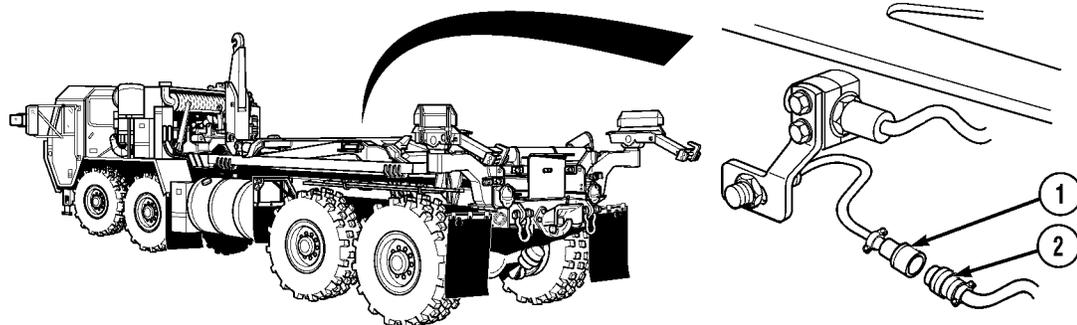

- (1) Disconnect CHU proximity switch MC188 connector (1) from CHU wire harness (2).

Organizational Maintenance Instructions (Cont)

4-37.1 CONTAINER HANDLING UNIT (CHU) PROXIMITY SWITCH AND SENSING PLATE REPLACEMENT/ADJUSTMENT (HOOK ARM UP) (CONT).

- (2) Remove two nuts (3) and proximity switch (4) from proximity switch mount (5).
- (3) Remove two screws (6), lockwashers (7), and proximity switch mount (5) from two clamp halves (8). Discard lockwashers.

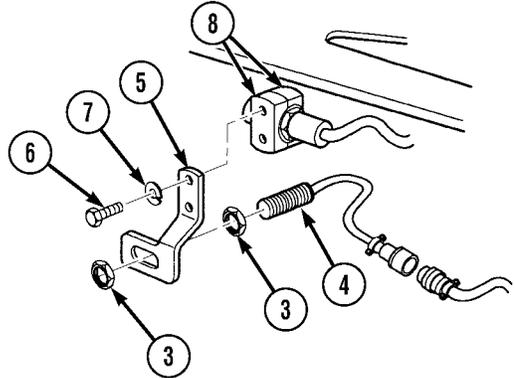

NOTE

Perform step (4) if sensor plate is damaged.

- (4) Remove sensor plate (9) from LHS hook arm (10).

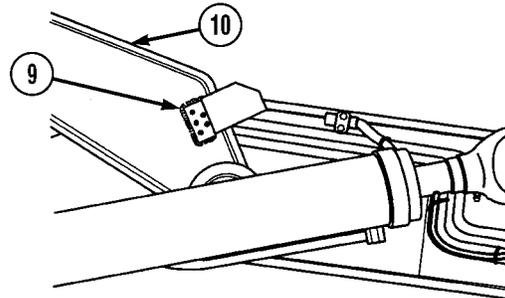

b. Installation.

- (1) Connect batteries (TM 9-2320-279-20).

NOTE

- Perform steps (2) through (18) if sensor plate was removed.
- LHS is being raised to expose area to install sensor plate.
- LHS will only operate when transmission range selector is in N (Neutral).

- (2) Start engine and stow LHS (TM 9-2320-279-10).

Organizational Maintenance Instructions (Cont)

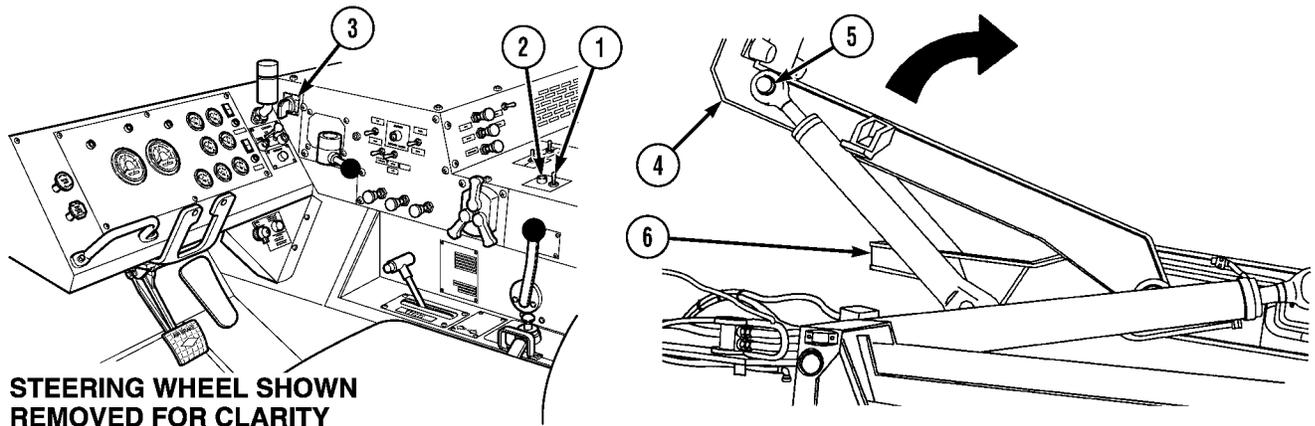

STEERING WHEEL SHOWN
REMOVED FOR CLARITY

CAUTION

Engine speed must be at idle before using hydraulic selector switch, or damage to equipment may result.

- (3) Put PTO ENGAGE switch (1) in ON position. Make sure indicator light (2) comes on.
- (4) Set hydraulic selector switch (3) to MAN H.A. position and raise hook arm (4) until hook arm cylinder pivot pin (5) is 25 in. (63.5 cm) from main frame (6).
- (5) Set hydraulic selector switch (3) to MAN M.F. position and raise main frame (6) until hook arm cylinder pivot pin (5) is 45 in. (114.3 cm) from main frame (6).
- (6) Shut OFF engine.
- (7) Disconnect batteries (TM 9-2320-279-20).

Organizational Maintenance Instructions (Cont)

4-37.1 CONTAINER HANDLING UNIT (CHU) PROXIMITY SWITCH AND SENSING PLATE REPLACEMENT/ADJUSTMENT (HOOK ARM UP).

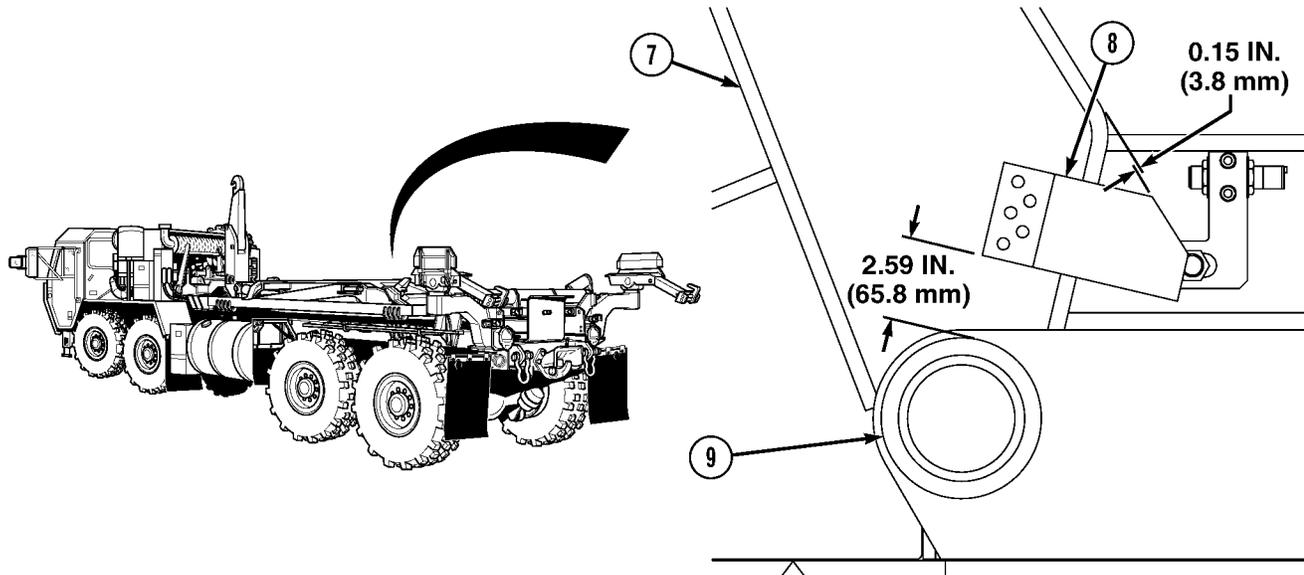

- (8) Measure and mark an area on hook arm (7) for sensor plate (8) to be mounted as shown.

WARNING

CARC paint contains isocyanate (HDI) which is highly irritating to skin and respiratory system. High concentrations of HDI can produce symptoms of itching and reddening of skin, a burning sensation in throat and nose, and watering of the eyes. In extreme concentrations, HDI can cause cough, shortness of breath, pain during respiration, increased sputum production, and chest tightness. The following precautions must be taken whenever using CARC paint:

- ALWAYS use air line respirators when using CARC paint unless air sampling shows exposure to be below standards. Use chemical cartridge respirator if air sampling is below standards.
- DO NOT let skin or eyes come in contact with CARC paint. Always wear protective equipment (gloves, ventilation mask, safety goggles, etc.).
- DO NOT use CARC paint without adequate ventilation.
- NEVER weld or cut CARC-coated materials.
- DO NOT grind or sand painted equipment without high-efficiency, air-purifying respirators in use.
- BE AWARE of CARC paint exposure symptoms; symptoms can occur a few days after initial exposure. Seek medical help immediately if symptoms are detected.

- (9) Grind off paint in area marked in step (8) for sensor plate (8) to be mounted.
- (10) Mark hook arm (7) 2.59 in. (65.8 cm) from boss (9) on hook arm.
- (11) Align sensor plate (8) 0.15 in. (3.8 mm) below top edge of hook arm (7).

Organizational Maintenance Instructions (Cont)

- (12) Position sensor plate (8) with two clamps on hook arm (7) as shown.
- (13) Mark line around sensor plate (8) on hook arm (7).
- (14) Remove two clamps and sensor plate (8) from hook arm (7).

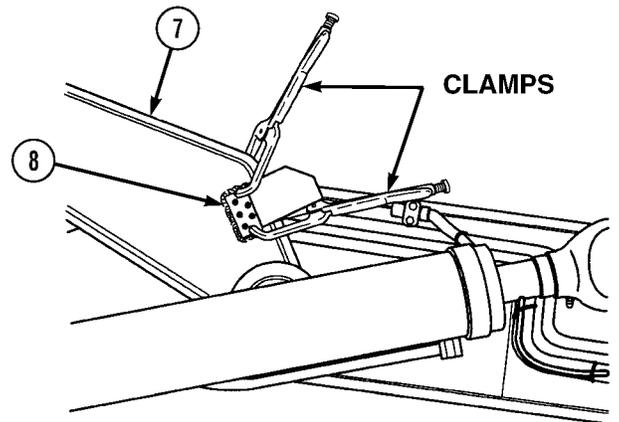
**WARNING**

Adhesives, solvents, and sealing compounds can burn easily, can give off harmful vapors, and are harmful to skin and clothing. To avoid injury or death, keep away from open fire and use in well-ventilated area. If adhesive, solvent, or sealing compound gets on skin or clothing, wash immediately with soap and water.

NOTE

Mix epoxy according to directions on package.

- (15) Mix epoxy and apply to sensor plate (8) and hook arm (7).

NOTE

Epoxy takes approximately 15 minutes to cure.

- (16) Clamp sensor plate (8) to hook arm (7) in position marked until cured.
- (17) Remove clamps from hook arm (7).
- (18) Prime and paint area as necessary (TM 43-0139).
- (19) Install two screws (10), lockwashers (11), and proximity switch mount (12) on two clamp halves (13).
- (20) Install CHU proximity switch (14) and two nuts (15) on proximity switch mount (12).

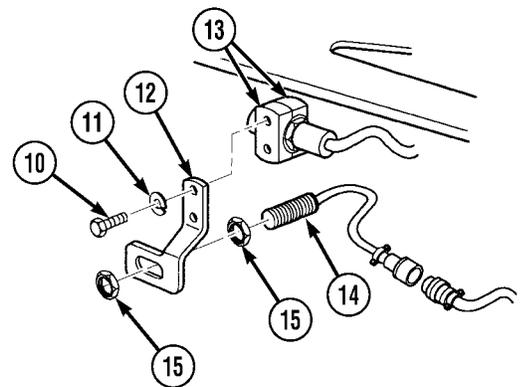

Organizational Maintenance Instructions (Cont)

4-37.1 CONTAINER HANDLING UNIT (CHU) PROXIMITY SWITCH AND SENSING PLATE REPLACEMENT/ADJUSTMENT (HOOK ARM UP).

- (21) Connect CHU proximity switch MC188 connector (16) on CHU wire harness (17).

NOTE

Do not paint tip of LED light. LED light is used during troubleshooting.

- (22) Prime and paint sides of LED light (18) on proximity switch (14) (TM 43-0139).

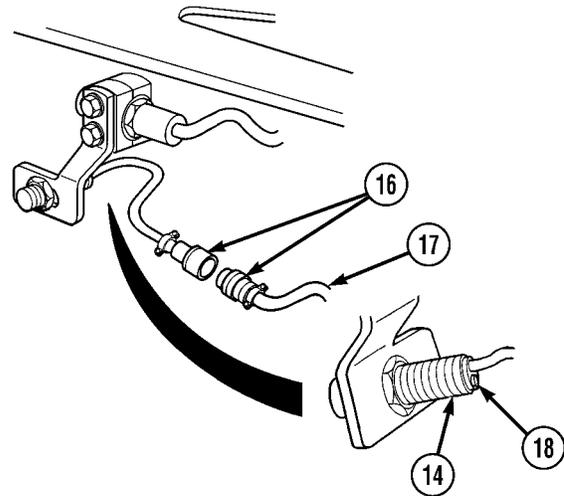

c. Adjustment.

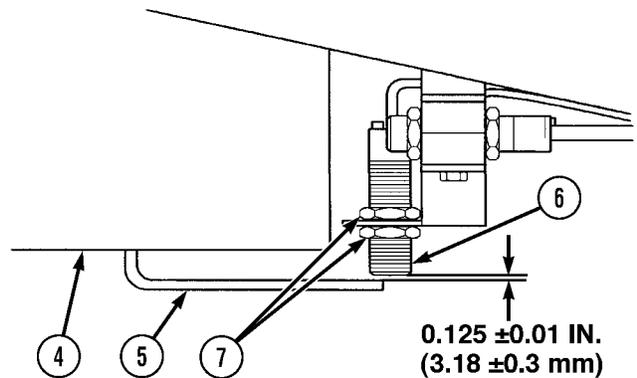
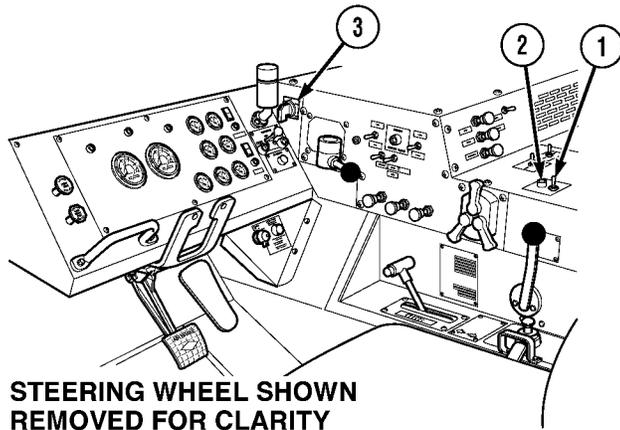

- (1) Connect batteries (TM 9-2320-279-20).
- (2) Start engine, set hydraulic selector switch (3) to MAN H.A. position, and raise hook arm (4) until sensor plate (5) covers approximately half of proximity switch (6) (TM 9-2320-364-10).
- (3) Put PTO ENGAGE switch (1) in ON position. Make sure indicator light (2) comes on.
- (4) Shut OFF engine.
- (5) Using feeler gage, adjust clearance between CHU proximity switch (6) and sensor plate (5) to 0.125 ± 0.01 in. (3.18 ± 0.3 mm) and tighten nuts (7).

d. Follow-on Maintenance.

- (1) Check operation of hook arm (Para 2-9).
- (2) Remove wheel chocks (TM 9-2320-279-10).
- (3) Install FLA (Para 2-10.11).

END OF TASK

Organizational Maintenance Instructions (Cont)

4-37.2 CONTAINER HANDLING UNIT (CHU) MAIN FRAME PROXIMITY SWITCH REPLACEMENT/ADJUSTMENT.

This task covers:

- | | |
|-----------------|--------------------------|
| a. Removal | c. Adjustment |
| b. Installation | d. Follow-on Maintenance |

INITIAL SETUP

Models
M1120

References
None

Test Equipment
None

Equipment Condition

<i>TM or Para</i>	<i>Condition Description</i>
TM 9-2320-279-10	Engine OFF
TM 9-2320-279-10	Wheels chocked
TM 9-2320-279-20	Batteries disconnected

Special Tools
Tool Kit, General Mechanic's Automotive, Item 33, Appendix B
Gage, Feeler, Item 9, Appendix B

Special Environmental Conditions
None

Supplies
None

General Safety Instructions
None

Personnel Required
MOS 63S, Heavy wheel vehicle mechanic

a. Removal.

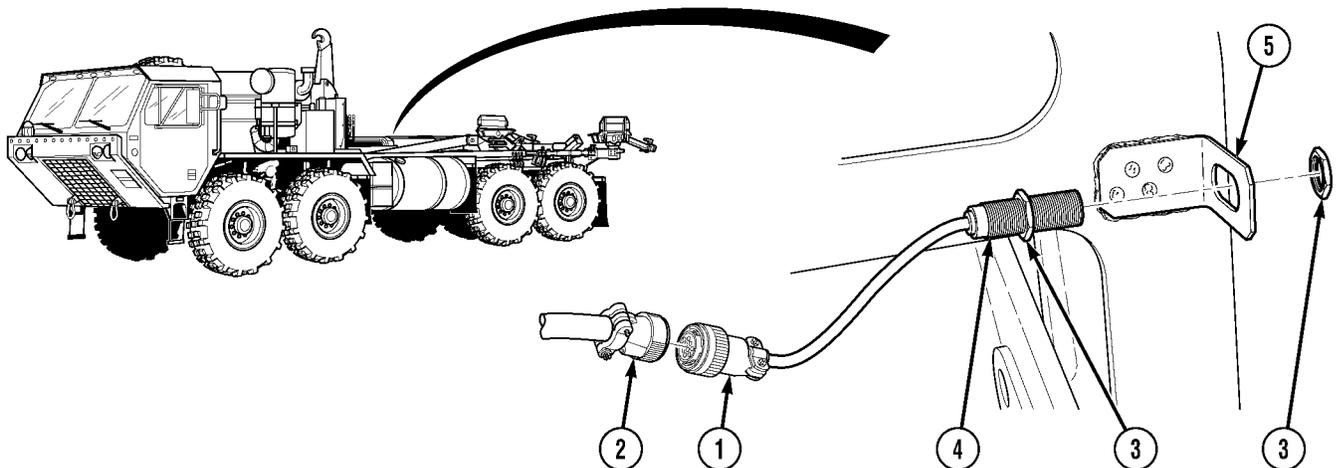

- (1) Disconnect CHU proximity switch MC 82B connector (1) from CHU wire harness (2).
- (2) Remove two nuts (3) and proximity switch (4) from proximity switch mount (5).

Organizational Maintenance Instructions (Cont)

4-37.2 CONTAINER HANDLING UNIT (CHU) MAIN FRAME PROXIMITY SWITCH REPLACEMENT/ADJUSTMENT (CONT).

b. Installation.

- (1) Install CHU proximity switch (1) and two nuts (2) on proximity switch mount (3).
- (2) Connect CHU proximity switch MC 82B connector (4) on CHU wireharness (5).

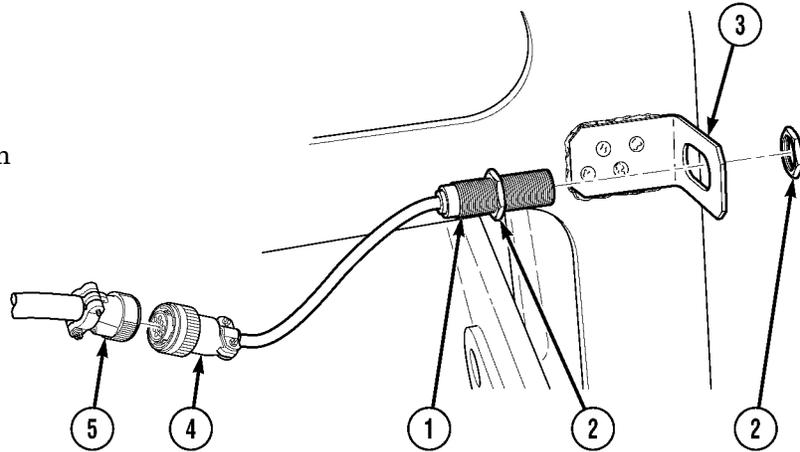

c. Adjustment.

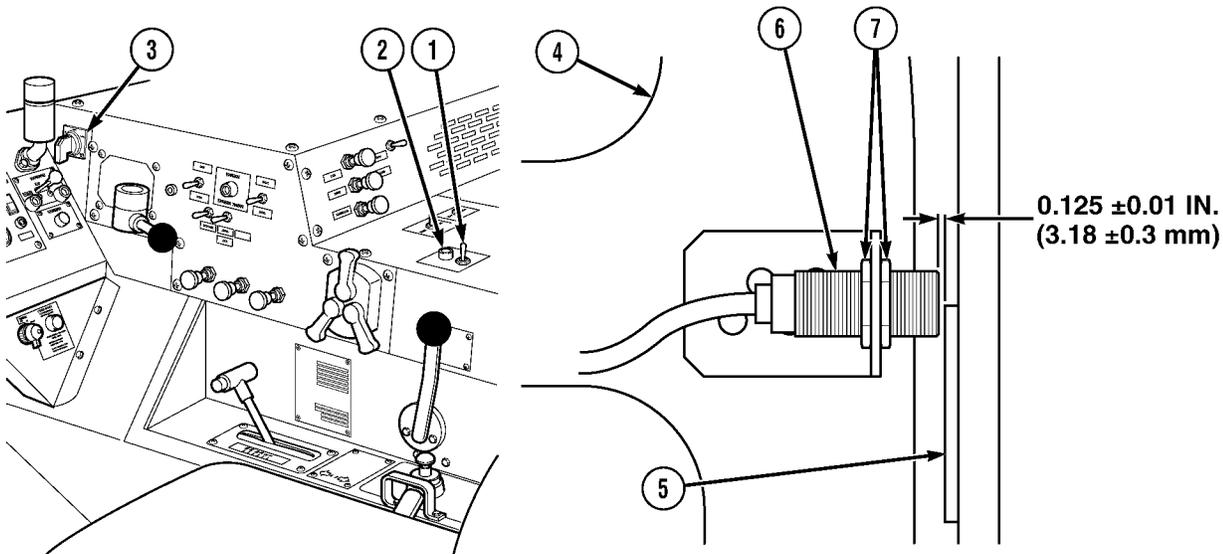

- (1) Connect batteries (TM 9-2320-279-20).
- (2) Start engine (TM 9-2320-279-10).
- (3) Put PTO ENGAGE switch (1) in ON position. Make sure indicator light (2) comes on.
- (4) Set hydraulic selector switch (3) to MAN H.A. position and raise main frame (4) 13.93 in. (35 cm) until sensor plate (5) covers approximately half of proximity switch (6) (Para 2-9).
- (5) Shut OFF engine (TM 9-2320-279-10).
- (6) Using feeler gage, adjust clearance between CHU proximity switch (6) and sensor plate (5) to 0.125 ± 0.01 in. (3.18 ± 0.3 mm) and tighten nuts (7).

d. Follow-on Maintenance.

- (1) Check operation of main frame (Para 2-9).
- (2) Remove wheel chocks (TM 9-2320-279-10).

END OF TASK

Organizational Maintenance Instructions (Cont)

4-38. MAIN FRAME LOCKOUT RELAY REPLACEMENT.										
This task covers:										
a. Removal	b. Installation	c. Follow-on Maintenance								
INITIAL SETUP										
<i>Models</i> M1120	<i>References</i> None									
<i>Test Equipment</i> None	<i>Equipment Condition</i> <table border="1"> <thead> <tr> <th>TM or Para</th> <th>Condition Description</th> </tr> </thead> <tbody> <tr> <td>TM 9-2320-279-10</td> <td>Engine OFF</td> </tr> <tr> <td>TM 9-2320-279-10</td> <td>Wheels chocked</td> </tr> <tr> <td>TM 9-2320-279-20</td> <td>Batteries disconnected</td> </tr> </tbody> </table>		TM or Para	Condition Description	TM 9-2320-279-10	Engine OFF	TM 9-2320-279-10	Wheels chocked	TM 9-2320-279-20	Batteries disconnected
TM or Para	Condition Description									
TM 9-2320-279-10	Engine OFF									
TM 9-2320-279-10	Wheels chocked									
TM 9-2320-279-20	Batteries disconnected									
<i>Special Tools</i> Tool Kit, General Mechanic's: Automotive, Item 33, Appendix B	<i>Special Environmental Conditions</i> None									
<i>Supplies</i> Lockwasher (4) Item 20, Appendix K	<i>General Safety Instructions</i> None									
<i>Personnel Required</i> MOS 63S, Heavy wheel vehicle mechanic										

a. Removal.

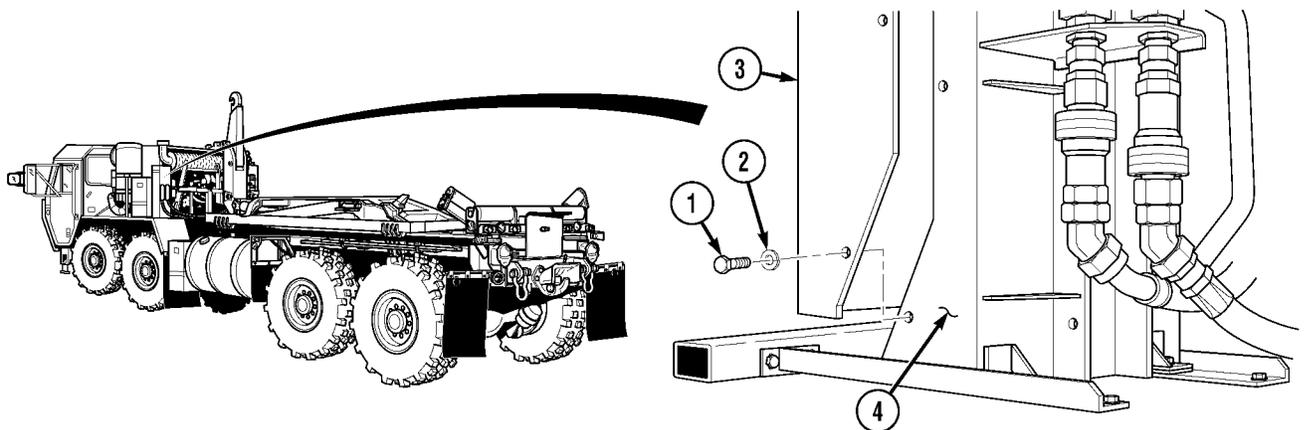

NOTE

Only remove center screw on engine side of LHS control box cover.

- (1) Remove four screws (1), lockwashers (2), and LHS control box cover (3) from bracket (4). Discard lockwashers.

Organizational Maintenance Instructions (Cont)

4-38. MAIN FRAME LOCKOUT RELAY REPLACEMENT (CONT).

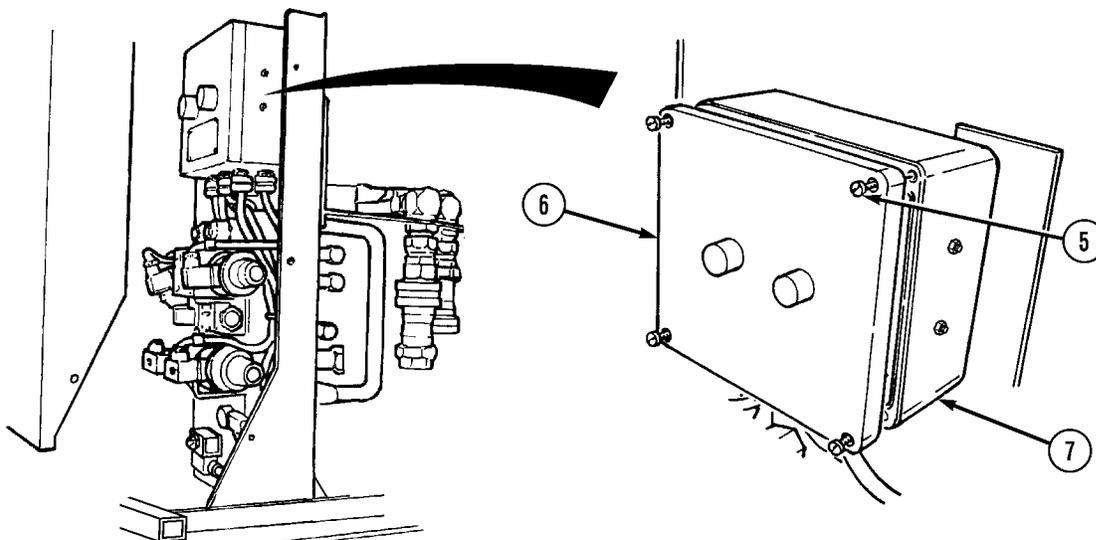

CAUTION

- Carefully remove junction box cover to avoid pulling out wires, damage to wires may result.
- When opening the main junction box do not pull or allow front of junction box to hang by the wire connections. Failure to comply will damage the wire connections.

(2) Loosen four captive screws (5) and remove main junction box cover (6) from junction box (7).

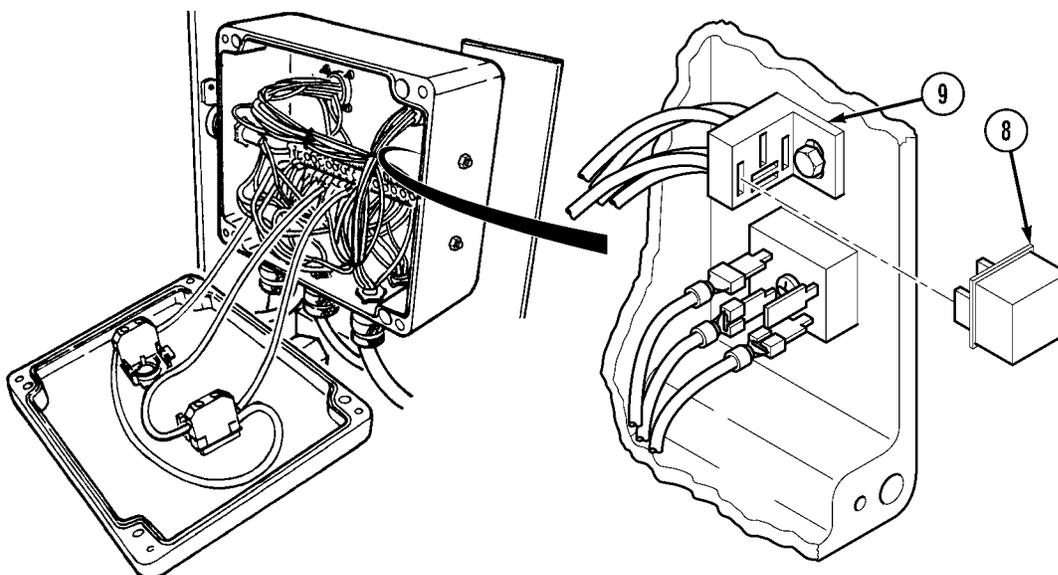

(3) Remove relay (8) from relay socket (9).

Organizational Maintenance Instructions (Cont)

b. Installation.

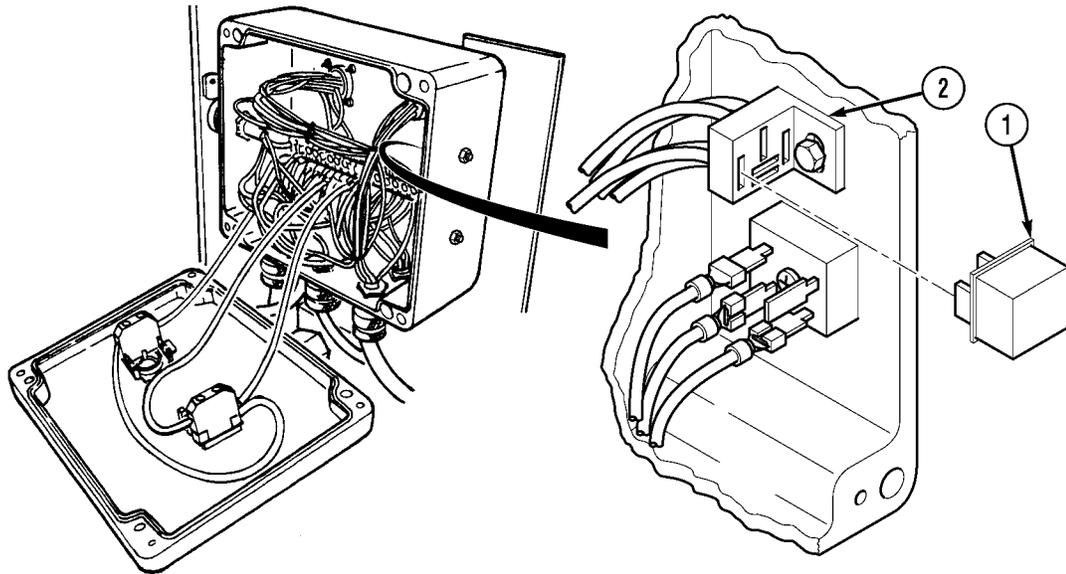

- (1) Install relay (1) on relay socket (2).
- (2) Install main junction box cover (3) on junction box (4) with four captive screws (5).

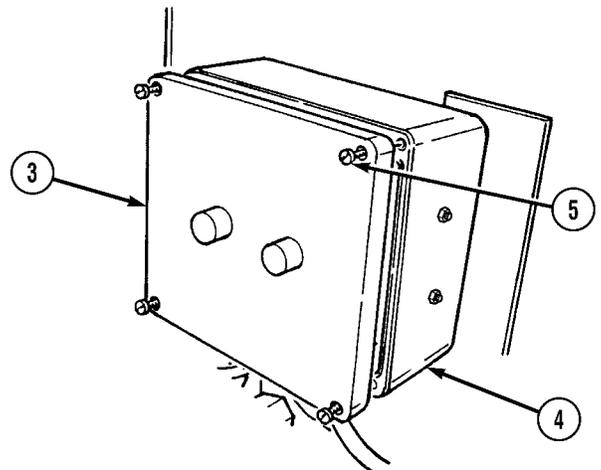

- (3) Install LHS control box cover (6) on bracket (7) with four screws (8) and lockwashers (9).

c. Follow-on Maintenance.

- (1) Connect batteries (TM 9-2320-279-20).
- (2) Remove wheel chocks (TM 9-2320-279-10).

END OF TASK

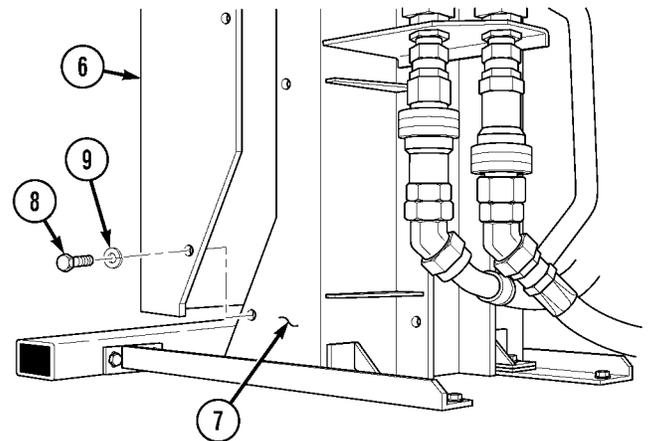

Organizational Maintenance Instructions (Cont)

4-39. SAFE LOWERING BUTTON REPLACEMENT.										
This task covers:										
a. Removal	b. Installation	c. Follow-on Maintenance								
INITIAL SETUP										
<i>Models</i> M1120	<i>References</i> None									
<i>Test Equipment</i> None	<i>Equipment Condition</i> <table border="0"> <tr> <td><i>TM or Para</i></td> <td><i>Condition Description</i></td> </tr> <tr> <td>TM 9-2320-279-10</td> <td>Engine OFF</td> </tr> <tr> <td>TM 9-2320-279-10</td> <td>Wheels chocked</td> </tr> <tr> <td>TM 9-2320-279-20</td> <td>Batteries disconnected</td> </tr> </table>		<i>TM or Para</i>	<i>Condition Description</i>	TM 9-2320-279-10	Engine OFF	TM 9-2320-279-10	Wheels chocked	TM 9-2320-279-20	Batteries disconnected
<i>TM or Para</i>	<i>Condition Description</i>									
TM 9-2320-279-10	Engine OFF									
TM 9-2320-279-10	Wheels chocked									
TM 9-2320-279-20	Batteries disconnected									
<i>Special Tools</i> Tool Kit, General Mechanic's: Automotive, Item 33, Appendix B	<i>Special Environmental Conditions</i> None									
<i>Supplies</i> Adhesive (Item 1, Appendix F) Tags, Identification (Item 19, Appendix F) Lockwasher (6) (Item 20, Appendix K)	<i>General Safety Instructions</i> None									
<i>Personnel Required</i> MOS 63S, Heavy wheel vehicle mechanic										

a. Removal.

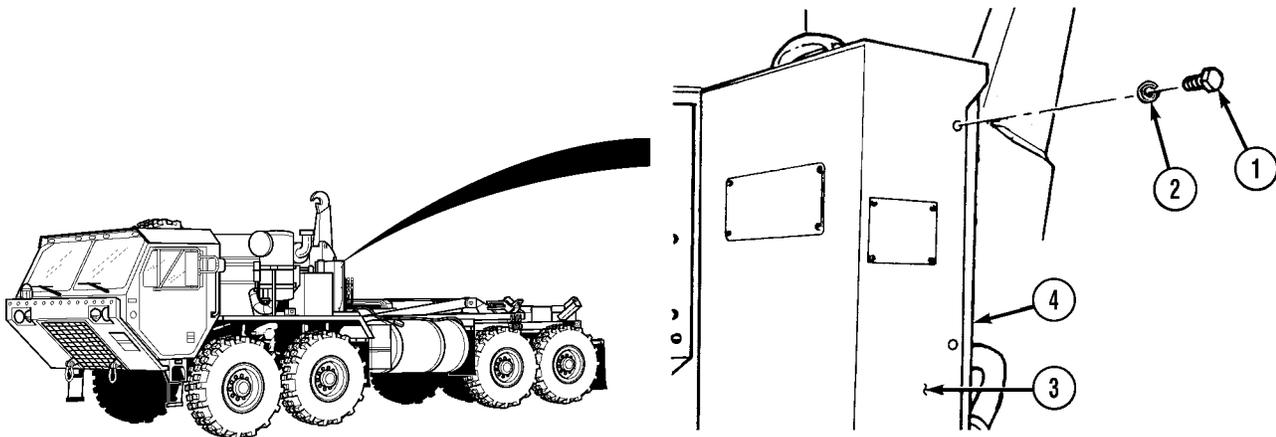

NOTE

Only remove center screw on engine side of LHS control box cover.

- (1) Remove four screws (1), lockwashers (2), and LHS control box cover (3) from bracket (4). Discard lockwashers.

Organizational Maintenance Instructions (Cont)

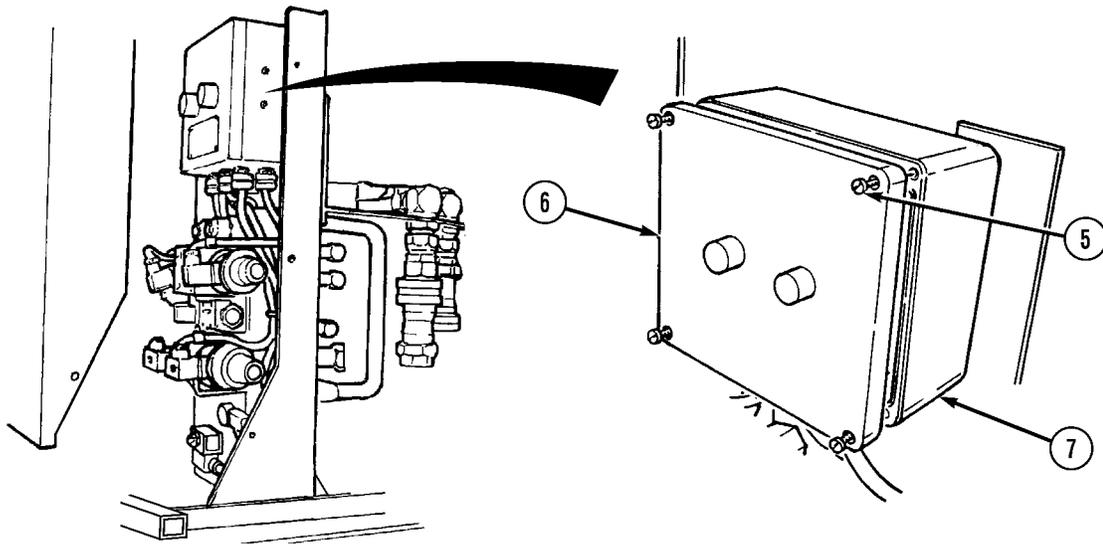

CAUTION

Carefully remove main junction box cover to avoid pulling out wires; damage to wires may result.

- (2) Loosen four captive screws (5) and main junction box cover (6) from main junction box (7).

NOTE

- Steps (3) and (4) are for left safe lowering button only.
- Steps (5) and (6) are for right safe lowering button only.
- Tag and mark wires prior to removal.

- (3) Loosen screw (8) and remove wire 1479 (9) and wire 1479 (10) from switch (11).
- (4) Loosen screw (12) and remove wire 1478 (13) from switch (11).

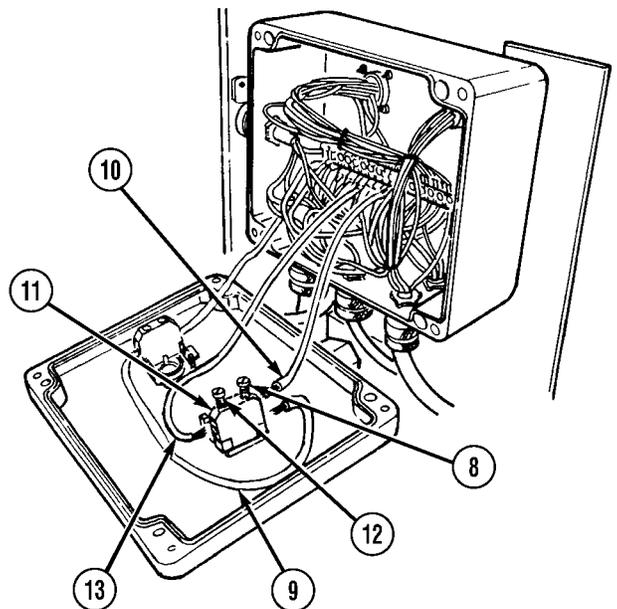

Organizational Maintenance Instructions (Cont)

4-39. SAFE LOWERING BUTTON REPLACEMENT (CONT).

- (5) Loosen screw (14) and remove wire 1477 (15) from switch (16).
- (6) Loosen screw (17) and remove wire 1479 (9) from switch (16).

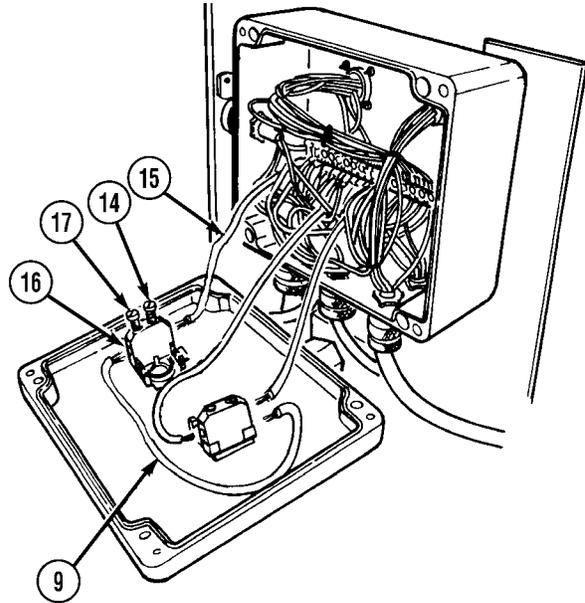

CAUTION

Pressing down on tab, or rotating tab more than required to lock tab, could break tab and/or switch.

NOTE

- Mark position of switch prior to removal.
 - Both switches are removed the same way.
 - Tab will only move a short distance.
- (7) Press down and rotate lock tab (18) clockwise on switch (11).
 - (8) Lift off switch (11) from button (19).
 - (9) Remove nut (20), seal (21), and button (19) from cover (6).

RIGHT SIDE SHOWN

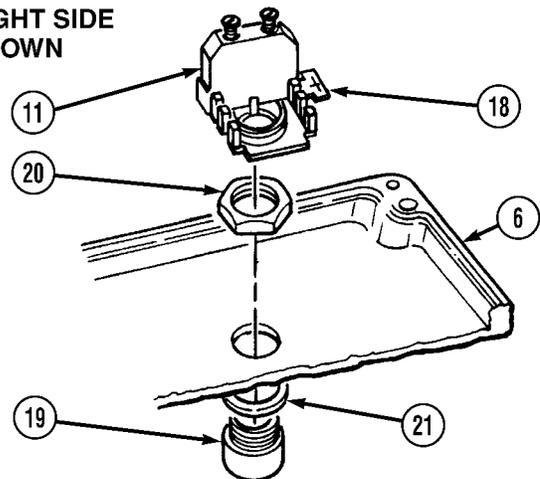

Organizational Maintenance Instructions (Cont)

b. Installation.

NOTE

Both switches are installed onto cover the same way.

- (1) Install seal (1) and button (2) in cover (3) with nut (4).

WARNING

Adhesives, solvents, and sealing compounds can burn easily, give off harmful vapors, and are harmful to skin and clothing. To avoid injury or death, keep away from open fire and use in well-ventilated area. If adhesive, solvent, or sealing compound gets on skin or clothing, wash immediately with soap and water.

- (2) Apply adhesive to back of switch (5).
- (3) Line up tabs in switch (5) and position switch (5) on button (2).

CAUTION

Pressing down on, or rotating tab more than required to lock tab, could break tab and/or switch.

NOTE

Tab will only move a short distance.

- (4) Press down and rotate lock tab (6) counterclockwise on switch (5).

NOTE

- Steps (5) and (6) are for right safe lowering button only.
 - Steps (7) and (8) are for left safe lowering button only.
- (5) Install wire 1479 (7) on switch (8) and tighten screw (9).
 - (6) Install wire 1477 (10) on switch (8) and tighten screw (11).

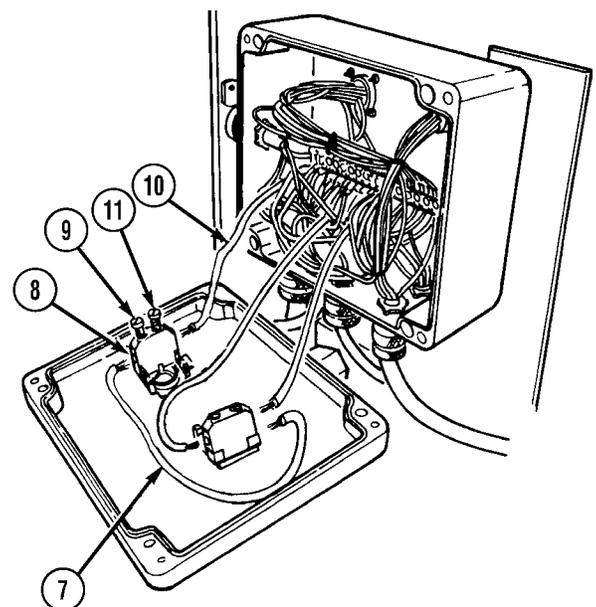
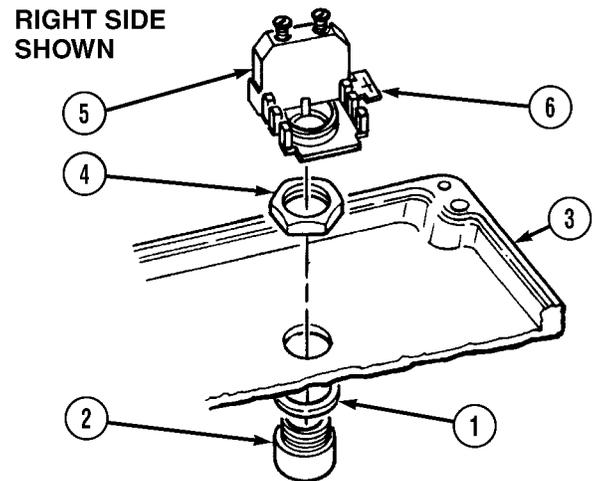

Organizational Maintenance Instructions (Cont)

4-39. SAFE LOWERING BUTTON REPLACEMENT (CONT).

- (7) Install wire 1478 (12) on switch (5) and tighten screw (13).
- (8) Install wire 1479 (7) and wire 1479 (14) on switch (5) and tighten screw (15).

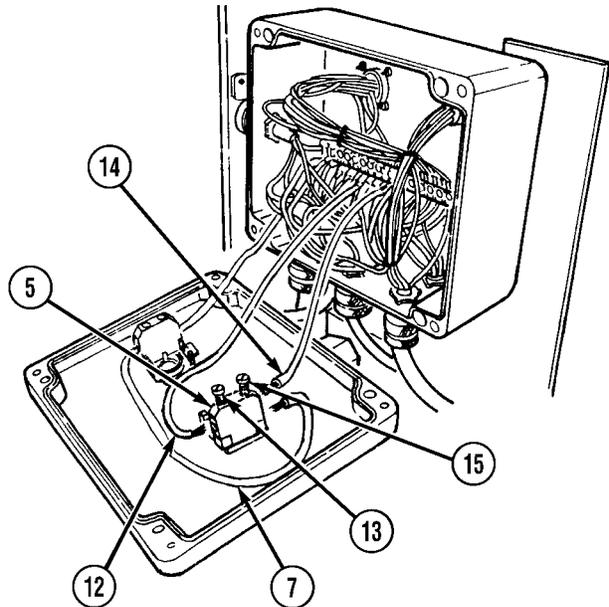

- (9) Install main junction box cover (3) on main junction box (16) with four captive screws (17).

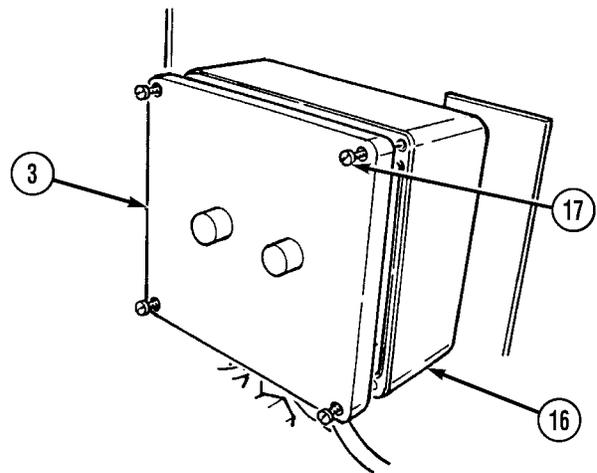

Organizational Maintenance Instructions (Cont)

- (10) Install LHS control box cover (18) on bracket (19) with four screws (20) and lockwashers (21).

c. Follow-on Maintenance.

- (1) Connect batteries (TM 9-2320-279-20).
- (2) Remove wheel chocks (TM 9-2320-279-10).

END OF TASK

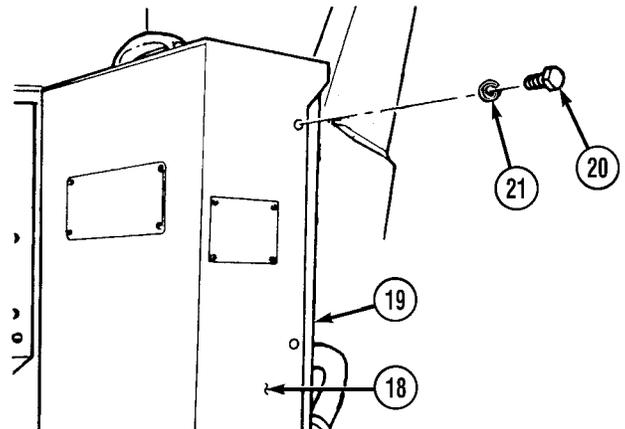

Organizational Maintenance Instructions (Cont)

4-40. LOAD HANDLING SYSTEM (LHS) RECTIFIER REPLACEMENT.										
This task covers:										
a. Removal	b. Installation	c. Follow-on Maintenance								
INITIAL SETUP										
<i>Models</i> M1120	<i>References</i> None									
<i>Test Equipment</i> None	<i>Equipment Condition</i> <table border="0"> <tr> <td><i>TM or Para</i></td> <td><i>Condition Description</i></td> </tr> <tr> <td>TM 9-2320-279-10</td> <td>Engine OFF</td> </tr> <tr> <td>TM 9-2320-279-10</td> <td>Wheels chocked</td> </tr> <tr> <td>TM 9-2320-279-20</td> <td>Batteries disconnected</td> </tr> </table>		<i>TM or Para</i>	<i>Condition Description</i>	TM 9-2320-279-10	Engine OFF	TM 9-2320-279-10	Wheels chocked	TM 9-2320-279-20	Batteries disconnected
<i>TM or Para</i>	<i>Condition Description</i>									
TM 9-2320-279-10	Engine OFF									
TM 9-2320-279-10	Wheels chocked									
TM 9-2320-279-20	Batteries disconnected									
<i>Special Tools</i> Tool Kit, General Mechanic's: Automotive, Item 33, Appendix B	<i>Special Environmental Conditions</i> None									
<i>Supplies</i> Adhesive, Item 1, Appendix F Tags, Identification, Item 19, Appendix F Lockwasher (4), Item 15, Appendix K	<i>General Safety Instructions</i> None									
<i>Personnel Required</i> MOS 63S, Heavy wheel vehicle mechanic										

a. Removal.

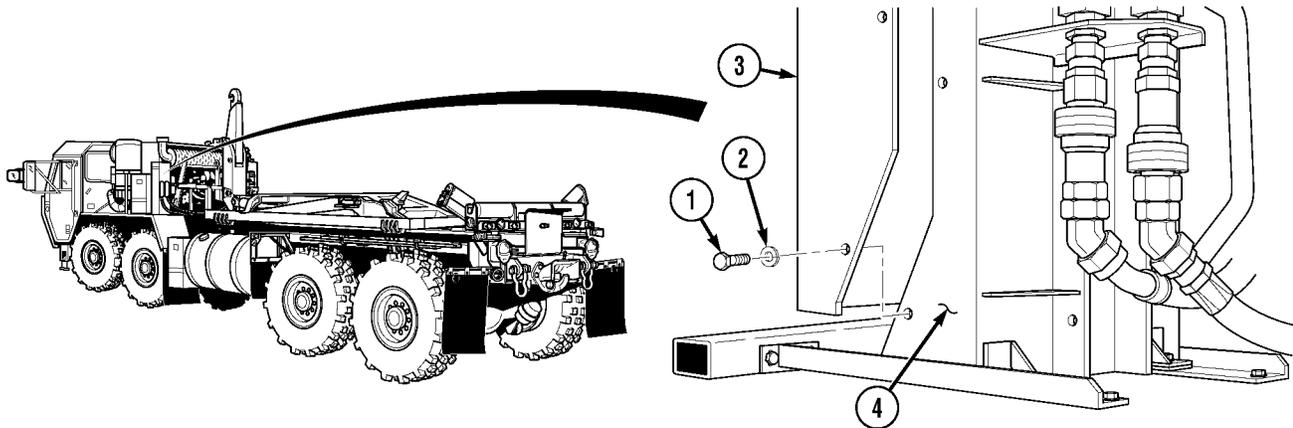

NOTE

Only remove center screw on engine side of LHS control box cover.

- (1) Remove four screws (1), lockwashers (2), and LHS control box cover (3) from bracket (4). Discard lockwashers.

Organizational Maintenance Instructions (Cont)

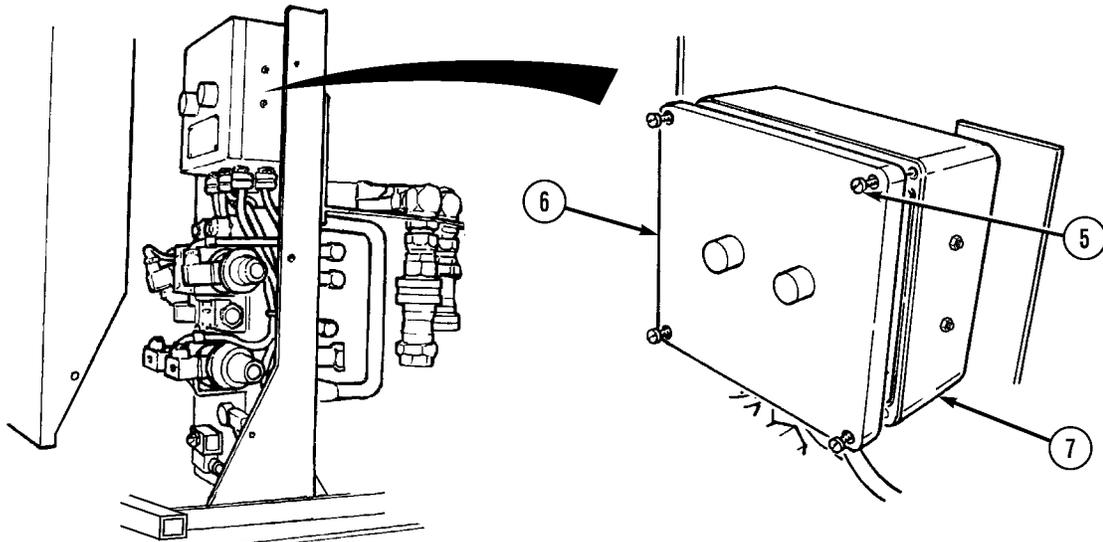

CAUTION

- Carefully remove main junction box cover to avoid pulling out wires, damage to wires may result.
- When opening the main junction box do not pull or allow front of junction box to hang by the wire connections. Failure to comply will damage the wire connections.

(2) Loosen four captive screws (5) and main junction box cover (6) from junction box (7).

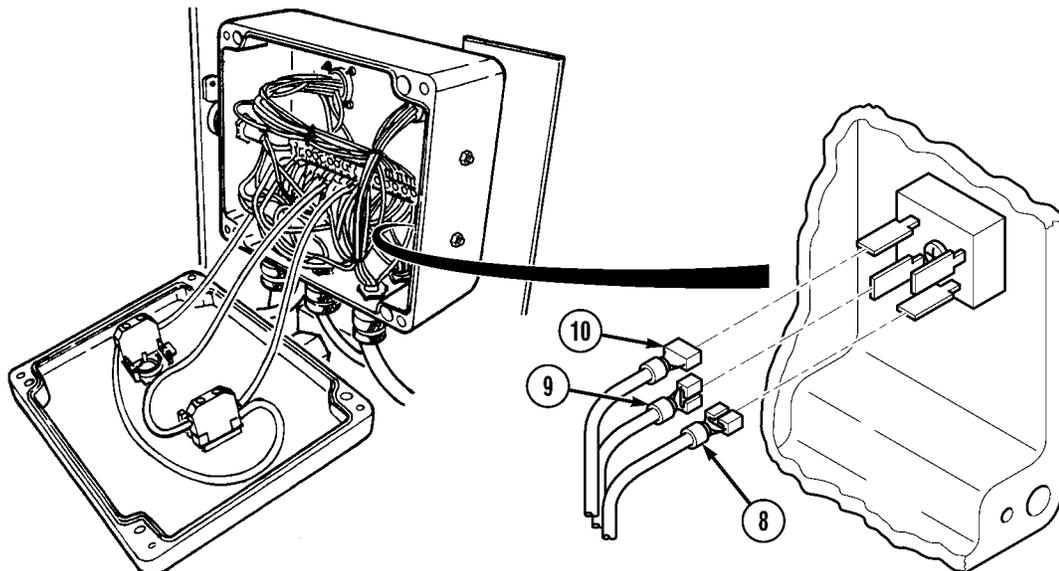

NOTE

Tag and mark all wires prior to disconnecting.

(3) Remove wire 1478 (8), 1480 (9), and 1463 (10).

Organizational Maintenance Instructions (Cont)

4-40. LOAD HANDLING SYSTEM (LHS) RECTIFIER REPLACEMENT (CONT).

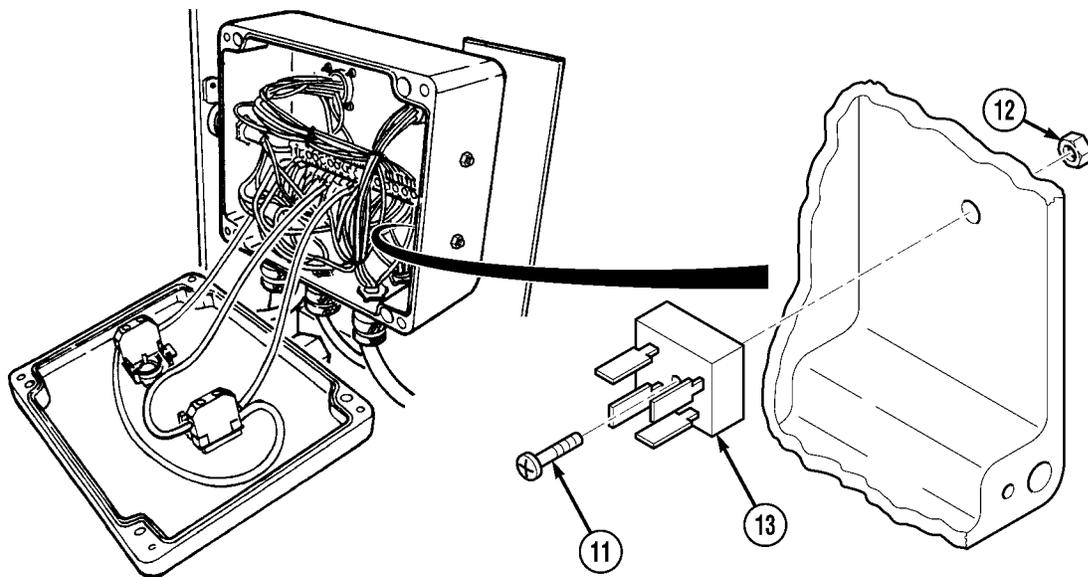

(4) Remove capscrew (11), locknut (12), and rectifier (13).

b. Installation

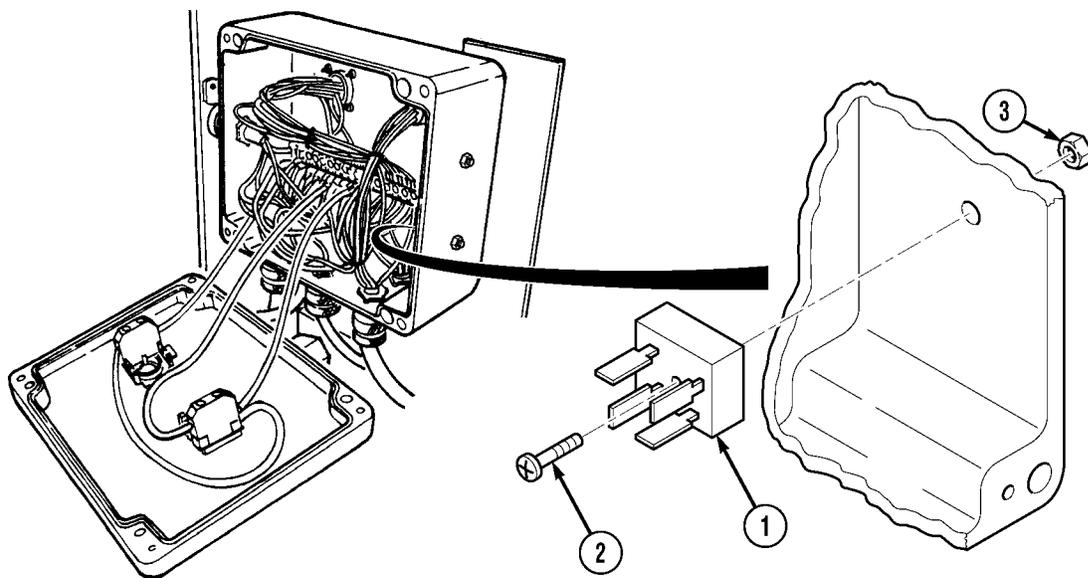

(1) Apply adhesive to back of rectifier (1).
(2) Install rectifier (1) with capscrew (2) and locknut (3).

Organizational Maintenance Instructions (Cont)

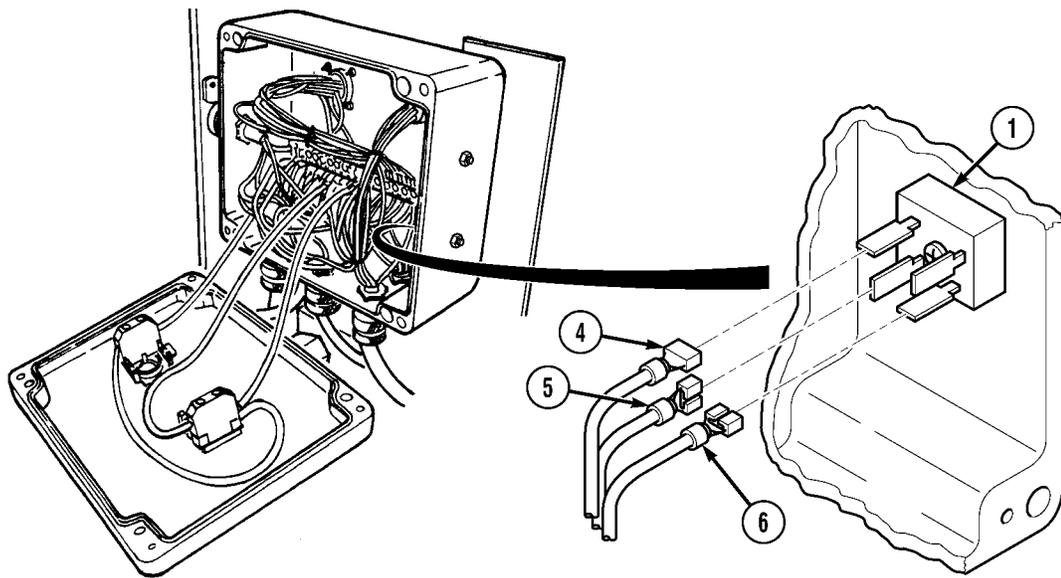

- (3) Install wire 1463 (4), 1480 (5), and 1478 (6) onto rectifier (1).
- (4) Install main junction box cover (7) on junction box (8) with four captive screws (9).

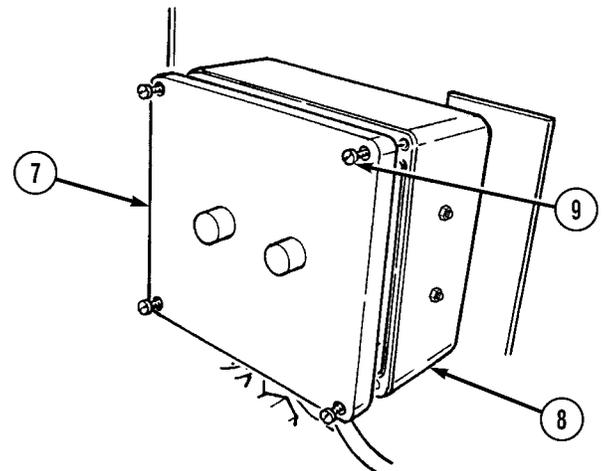

- (5) Install LHS control box cover (12) on bracket (13) with four screws (10) and lockwashers (11).

c. Follow-on Maintenance.

- (1) Connect batteries (TM 9-2320-279-20).
- (2) Remove wheel chocks (TM 9-2320-279-10).

END OF TASK

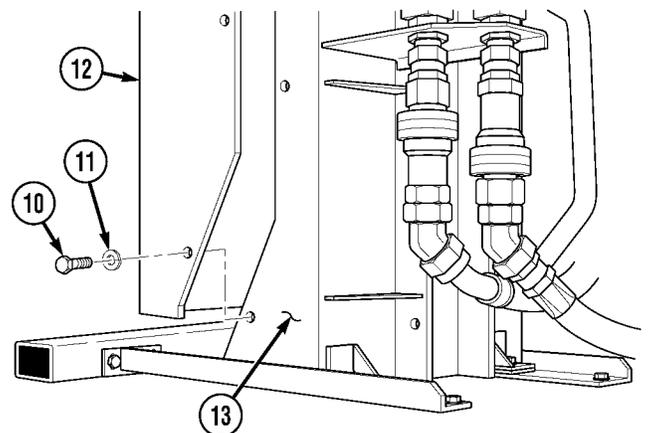

Organizational Maintenance Instructions (Cont)

4-41. LHS JUNCTION BOX REPLACEMENT.		
This task covers:		
a. Removal	b. Installation	c. Follow-on Maintenance
INITIAL SETUP		
<i>Models</i> M1120	<i>References</i> None	
<i>Test Equipment</i> None	<i>Equipment Condition</i>	
<i>Special Tools</i> Tool Kit, General Mechanic's: Automotive, Item 33, Appendix B	<i>TM or Para</i>	<i>Condition Description</i>
	TM 9-2320-279-10	Engine OFF
	TM 9-2320-279-10	Wheels chocked
	Para 2-9	LHS in transit position
	TM 9-2320-279-20	Batteries disconnected
<i>Supplies</i> Adhesive, Item 1, Appendix F Cable Ties, Item 4, Appendix F Cloth, Cleaning, Item 5, Appendix F Tags, Identification, Item 19, Appendix F	<i>Special Environmental Conditions</i> None	
	<i>General Safety Instructions</i> None	
<i>Personnel Required</i> MOS 63S, Heavy wheel vehicle mechanic		

a. Removal.

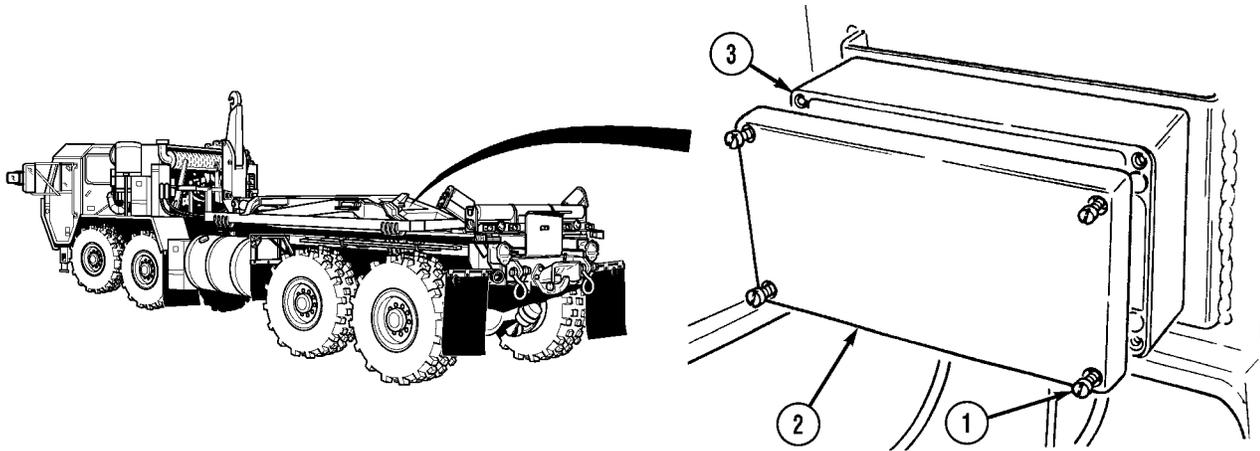

(1) Loosen four captive screws (1) and remove junction box cover (2) from junction box (3).

Organizational Maintenance Instructions (Cont)

NOTE

- Tag and mark wires prior to removal.
 - Remove cable ties as required.
- (2) Remove wire 1435 (4), wire 1474 (5), and wire 1466 (6) from terminal strip (7).
 - (3) Remove collar (8), washer (9), sealing ring (10), and cable (11) as an assembly from junction box (3).

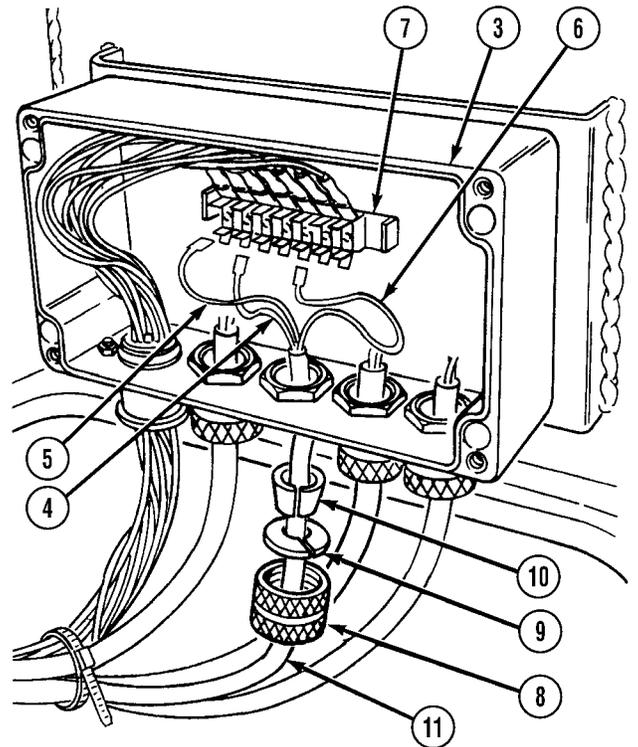

- (4) Remove wire 1435 (12), wire 1469 (13), and wire 1461 (14) from terminal strip (7).
- (5) Remove collar (8), washer (9), sealing ring (10), and cable (15) as an assembly from junction box (3).

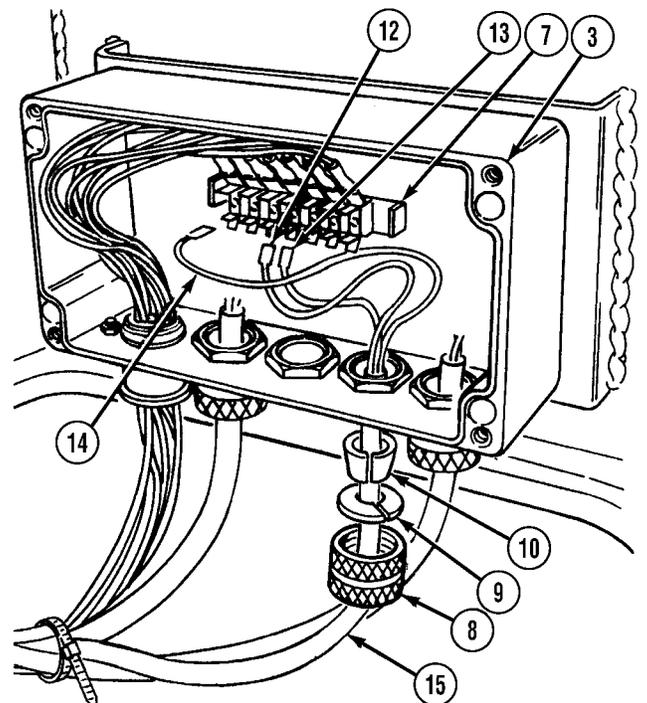

Organizational Maintenance Instructions (Cont)

4-41. LHS JUNCTION BOX REPLACEMENT (CONT).

- (6) Remove wire 1475 (16) and wire 1435 (17) from terminal strip (7).
- (7) Remove collar (8), washer (9), sealing ring (10), and cable (18) as an assembly from junction box (3).
- (8) Remove wire 1470 (19) and wire 1435 (20) from terminal strip (7).
- (9) Remove collar (8), washer (9), sealing ring (10), and cable (21) as an assembly from junction box (3).

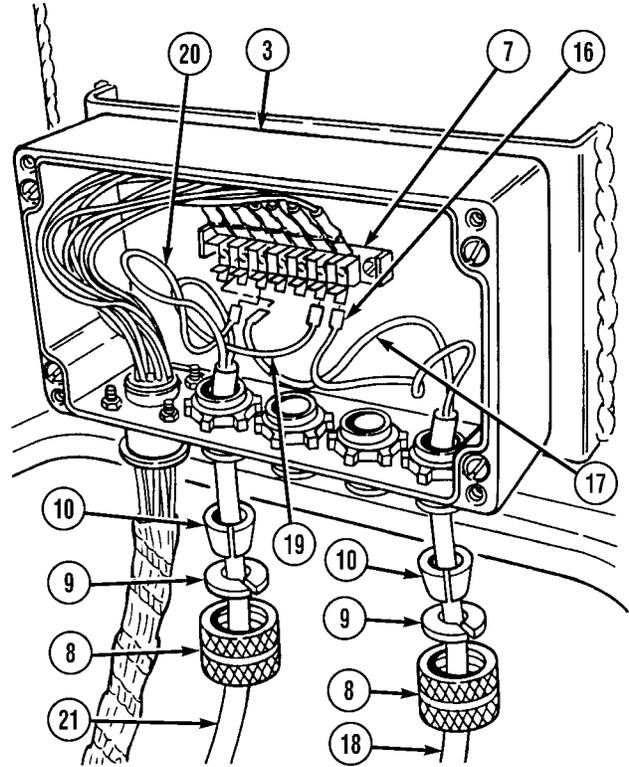

- (10) Remove MC87 connector (22) from connector (23).
- (11) Remove four screws (24), lockwashers (25), and junction box (3) from truck. Discard lockwashers.

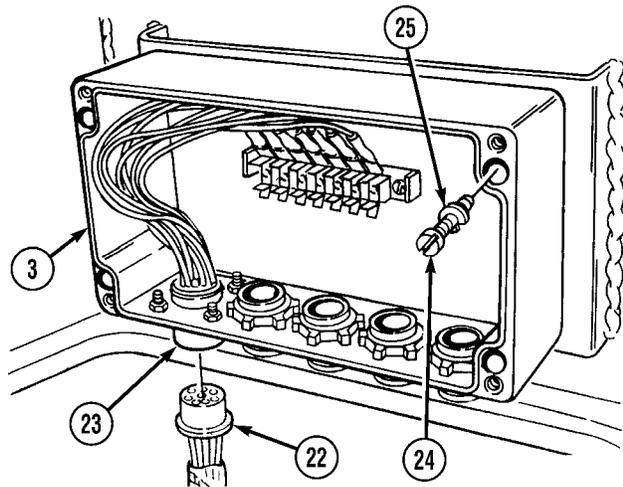

Organizational Maintenance Instructions (Cont)

- (12) Remove harness wires 1461 (26), 1435 (27), 1469 (28), 1469 (29), 1466 (30), 1470 (31), and 1475 (32) from terminal strip (7).
- (13) Remove two locknuts (33), screws (34), and terminal strip (7) from junction box (3). Discard locknuts.
- (14) Remove four locknuts (35) and bulkheads (36) from junction box (3). Discard locknuts.
- (15) Remove four locknuts (37), screws (38), connector (23), and harness (39) from junction box (3). Discard locknuts.

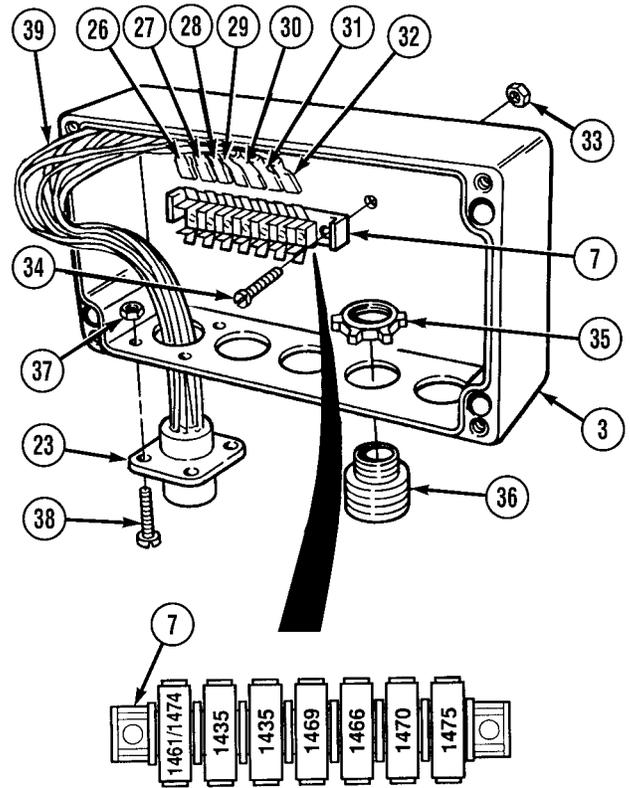

Organizational Maintenance Instructions (Cont)

4-41. LHS JUNCTION BOX REPLACEMENT (CONT).

b. Installation.

WARNING

Adhesives, solvents, and sealing compounds can burn easily, give off harmful vapors, and are harmful to skin and clothing. To avoid injury or death, keep away from open fire and use in well-ventilated area. If adhesive, solvent, or sealing compound gets on skin or clothing, wash immediately with soap and water.

NOTE

Wire numbers on harnesses match numbers on terminal strip.

- (1) Apply adhesive to back plate of connector (1).
- (2) Install harness (2) and connector (1) in junction box (3) with four screws (4) and locknuts (5).
- (3) Install four bulkheads (6) on junction box (3) with locknuts (7).
- (4) Apply adhesive to back plate of terminal strip (8).
- (5) Install terminal strip (8) with two screws (9) and locknuts (10).
- (6) Install wires 1461 (11), 1435 (12), 1435 (13), 1469 (14), 1466 (15), 1470 (16), and 1475 (17) on terminal strip (8).
- (7) Install junction box (3) on truck with four screws (18) and lockwashers (19).
- (8) Install MC87 connector (20) on connector (1).

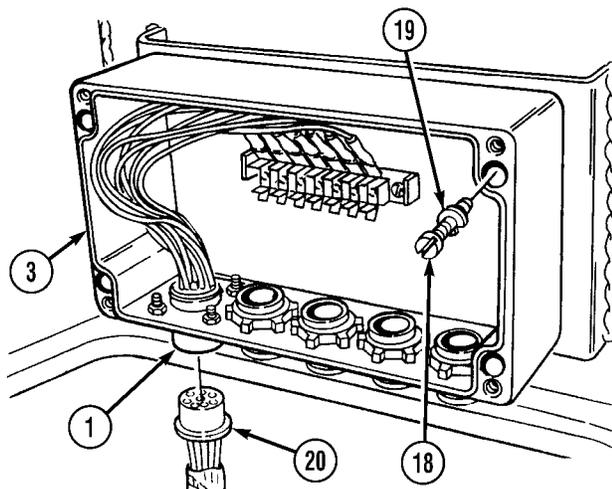
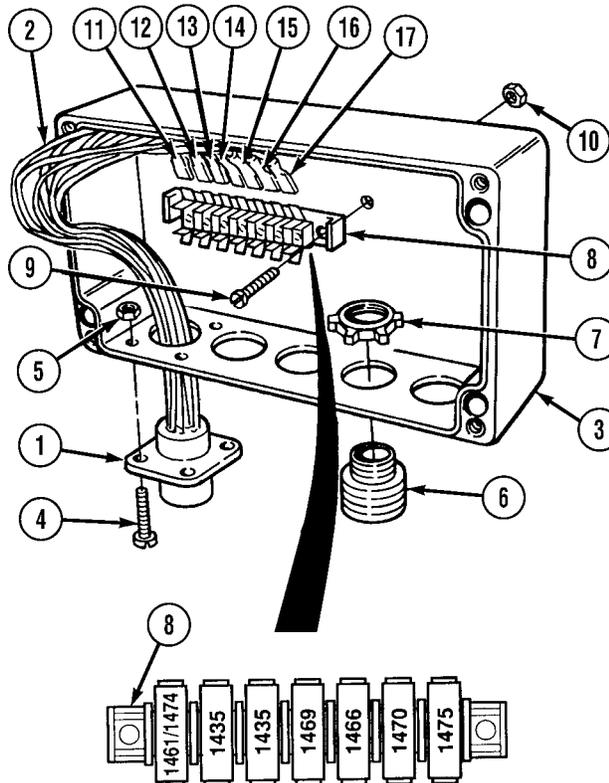

Organizational Maintenance Instructions (Cont)

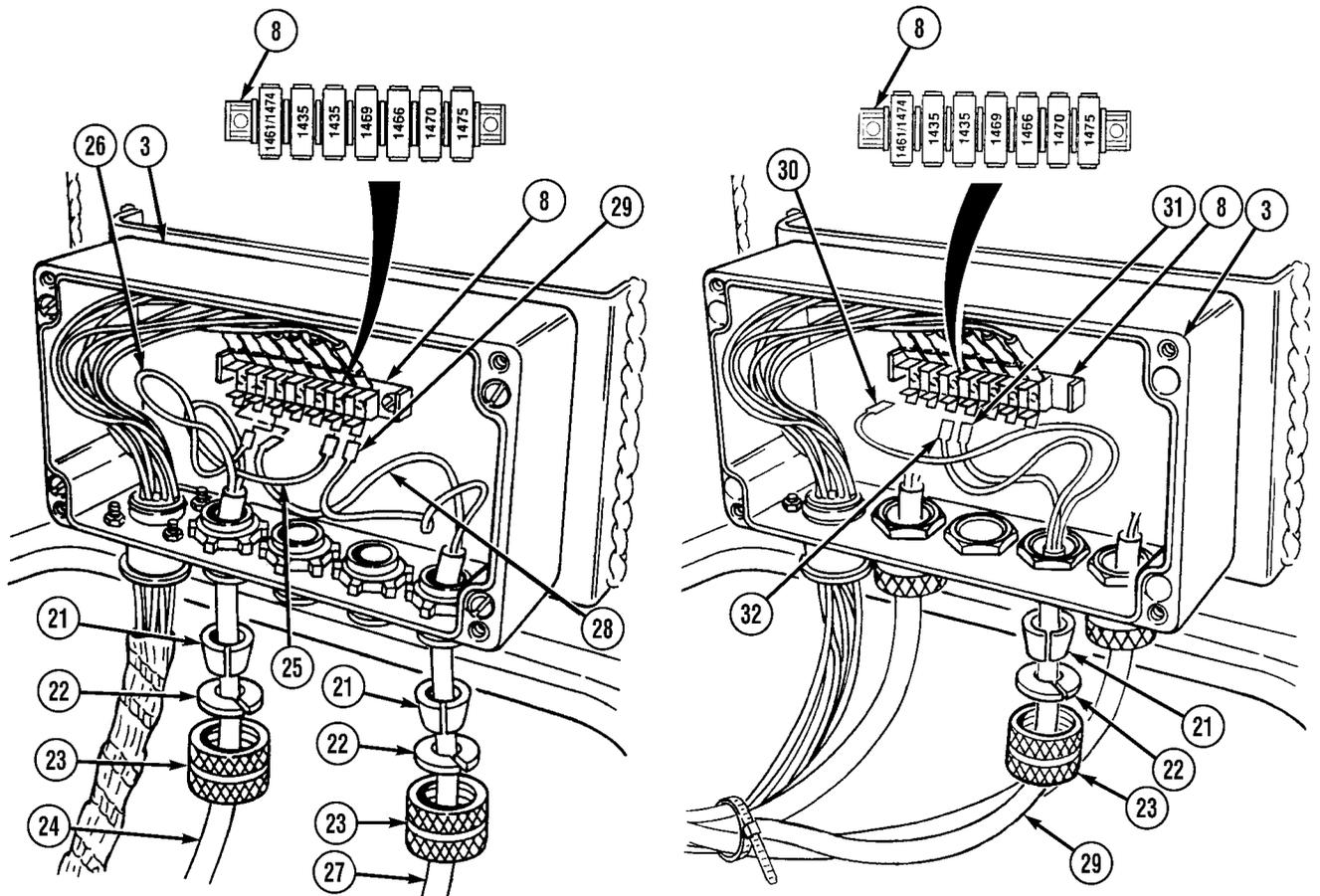

- (9) Install sealing ring (21), washer (22), collar (23), and cable (24) as an assembly on junction box (3).
- (10) Install wire 1470 (25) and wire 1435 (26) on terminal strip (8).
- (11) Install sealing ring (21), washer (22), collar (23), and cable (27) as an assembly on junction box (3).
- (12) Install wire 1435 (28) and wire 1475 (29) on terminal strip (8).
- (13) Install sealing ring (21), washer (22), collar (23), and cable (29) in junction box (3) as an assembly.
- (14) Install wire 1461 (30), wire 1469 (31), and wire 1435 (32) on terminal strip (8).

Organizational Maintenance Instructions (Cont)

4-41. LHS JUNCTION BOX REPLACEMENT (CONT).

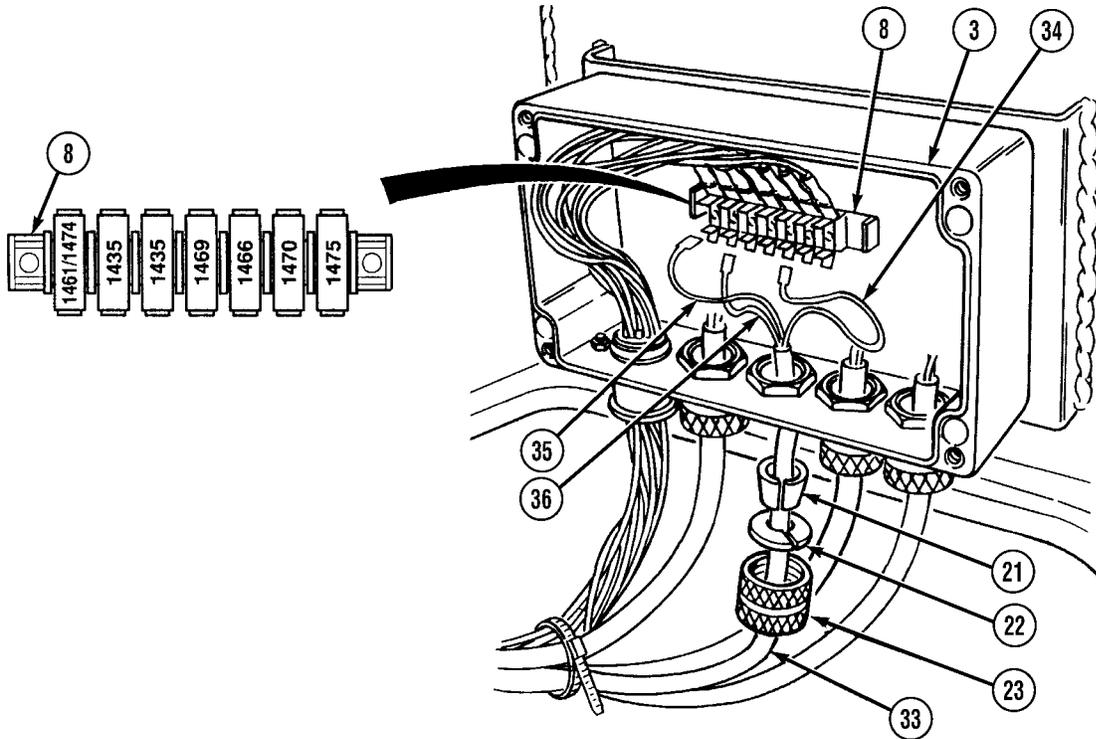

- (15) Install sealing ring (21), washer (22), collar (23), and cable (33) in junction box (3) as an assembly.
- (16) Install wire 1466 (34), wire 1474 (35), and wire 1435 (36) on terminal strip (8).
- (17) Install junction box cover (37) on junction box (3) with four captive screws (38).

c. Follow-on Maintenance.

- (1) Connect batteries (TM 9-2320-279-20).
- (2) Remove wheel chocks (TM 9-2320-279-10).

END OF TASK

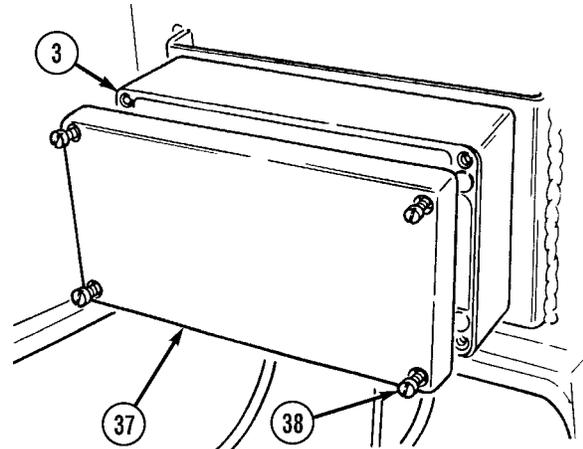

Organizational Maintenance Instructions (Cont)

4-42. MARKER/CLEARANCE LIGHT REPLACEMENT.		
This task covers:		
a. Removal	b. Installation	c. Follow-on Maintenance
INITIAL SETUP		
<i>Models</i> M1120	<i>References</i> None	
<i>Test Equipment</i> None	<i>Equipment Condition</i> <i>TM or Para</i> <i>Condition Description</i> TM 9-2320-279-10 Engine OFF TM 9-2320-279-10 Wheels chocked	
<i>Special Tools</i> Tool Kit, General Mechanic's: Automotive, Item 33, Appendix B	<i>Special Environmental Conditions</i> None	
<i>Supplies</i> Cable Ties Item 4, Appendix F Tags, Identification Item 19, Appendix F	<i>General Safety Instructions</i> None	
<i>Personnel Required</i> MOS 63S, Heavy wheel vehicle mechanic		

a. Removal.

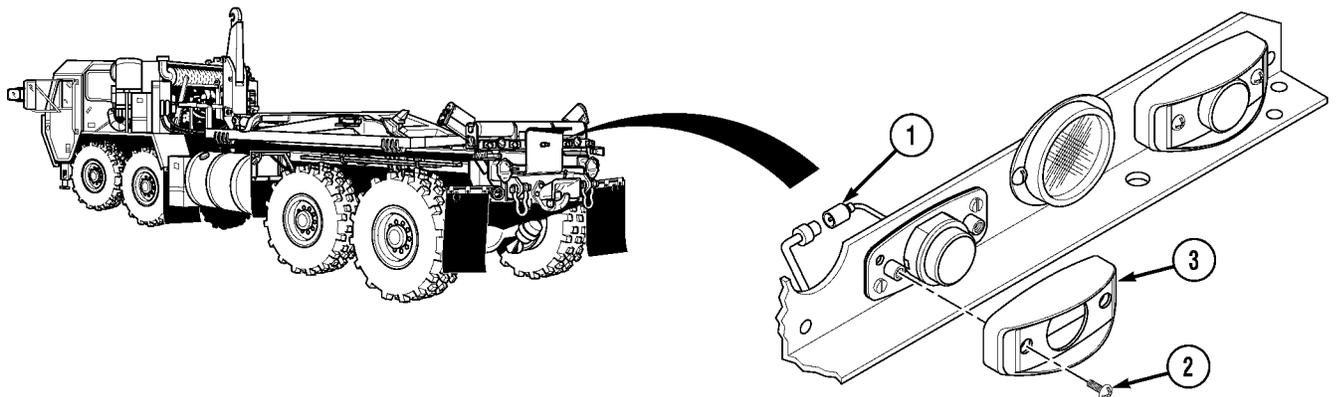

NOTE

- The marker lights and clearance lights are removed and installed the same way. The marker light is shown.
- Tag and mark all wires before disconnecting.
- Remove cable ties as needed.

- (1) Tag and disconnect wire (1)
- (2) Remove two screws (2) and outer bracket (3).

Organizational Maintenance Instructions (Cont)

4-42. MARKER/CLEARANCE LIGHT REPLACEMENT (CONT).

- (3) Remove light emitting diode (4).
- (4) Remove two nuts (5), screws (6), ground wire (7), mounting base (8), mounting gasket (9), and pigtail (10).

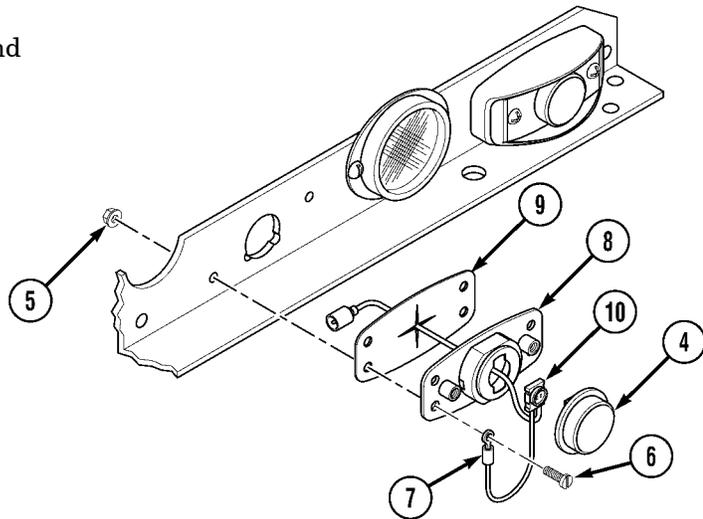

b. Installation.

- (1) Install mounting gasket (1), mounting base (2), pigtail (3), ground wire (4), two screws (5), and nuts (6). Tighten nuts.
- (2) Install light emitting diode (7).

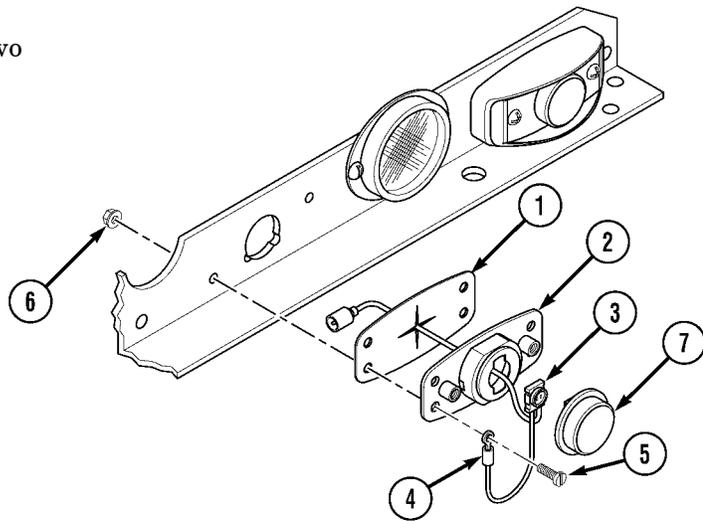

- (3) Install outer bracket (8) and two screws (9).
- (4) Connect wire (10).

c. Follow-on Maintenance. Remove wheel chocks (TM 9-2320-279-10).

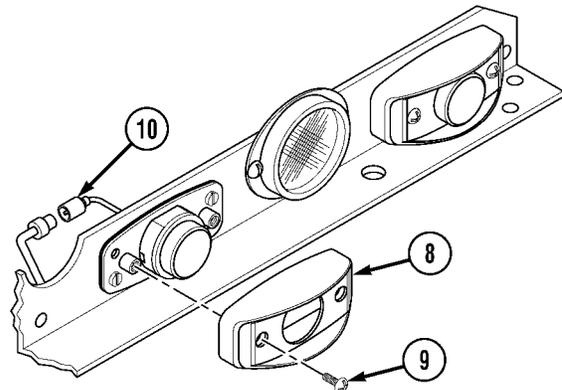

END OF TASK

Organizational Maintenance Instructions (Cont)

4-43. REAR LIGHT BAR ASSEMBLY REPLACEMENT.		
This task covers:		
a. Removal	b. Installation	c. Follow-on Maintenance
INITIAL SETUP		
<i>Models</i> M1120	<i>References</i> None	
<i>Test Equipment</i> None	<i>Equipment Condition</i>	
<i>Special Tools</i> Tool Kit, General Mechanic's: Automotive, Item 33, Appendix B	TM 9-2320-279-10	Engine OFF
	TM 9-2320-279-10	Wheels chocked
	Para 4-49	Bumper stop stinger bracket removed
<i>Supplies</i> Cable Ties Item 4, Appendix F Tags, Identification Item 19, Appendix F Lockwasher (2) Item 15, Appendix K	<i>Special Environmental Conditions</i> None	
<i>Personnel Required</i> MOS 63S, Heavy wheel vehicle mechanic	<i>General Safety Instructions</i> None	

a. Removal.

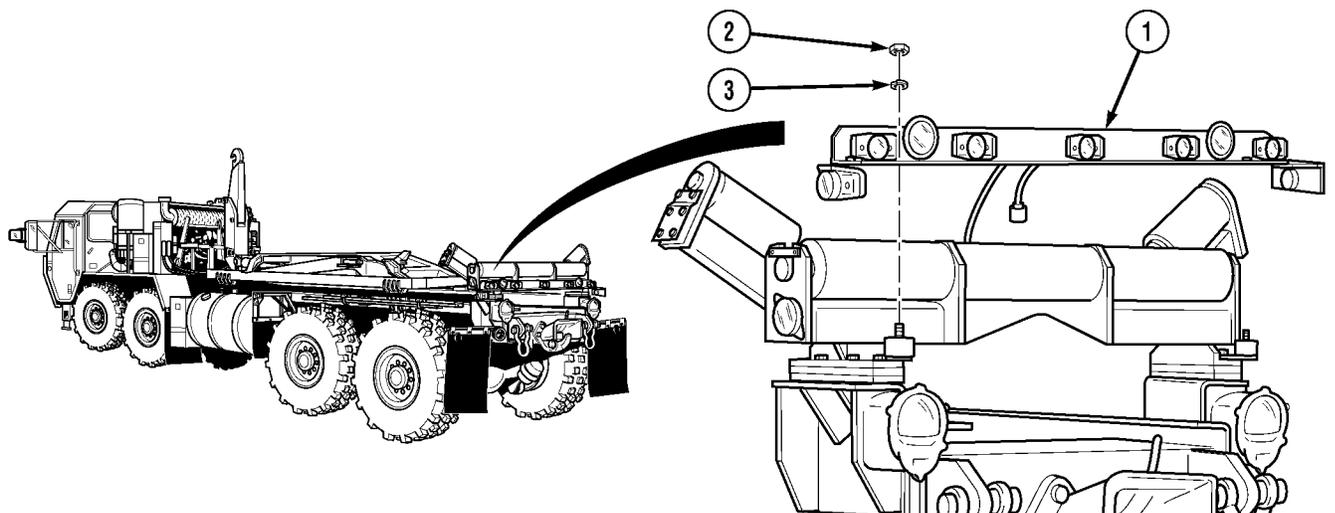

NOTE

- Tag and mark all wires before disconnecting.
- Cut wire ties as needed.

(1) Tag and disconnect wires to rear light bar (1)

(2) Remove two nuts (2), lockwashers (3), and rear light bar (1). Discard lockwashers.

Organizational Maintenance Instructions (Cont)

4-43. REAR LIGHT BAR ASSEMBLY REPLACEMENT (CONT).

b. Installation.

- (1) Install rear light bar (1), two lockwashers (2), and nuts (3).
- (2) Connect wires to rear light bar (1).

c. Follow-on Maintenance.

- (1) Install bumper stop stinger bracket (Para 4-49).
- (2) Remove wheel chocks (TM 9-2320-279-10).

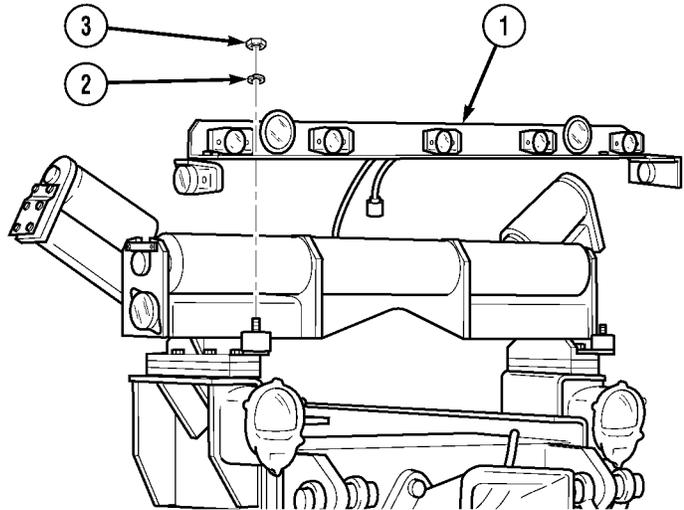

END OF TASK

Organizational Maintenance Instructions (Cont)

4-43.1 CONTAINER HANDLING UNIT (CHU) REAR LIGHT BAR ASSEMBLY REPLACEMENT.		
This task covers:		
a. Removal	b. Installation	c. Follow-on Maintenance
INITIAL SETUP		
<i>Models</i> M1120	<i>References</i> None	
<i>Test Equipment</i> None	<i>Equipment Condition</i> <i>TM or Para</i> <i>Condition Description</i> TM 9-2320-279-10 Engine OFF TM 9-2320-279-10 Wheels chocked Para 4-49 Bumper stop stinger bracket removed.	
<i>Special Tools</i> Tool Kit, General Mechanic's: Automotive, Item 33, Appendix B	<i>Special Environmental Conditions</i> None	
<i>Supplies</i> Cable Ties, Item 4, Appendix F Tags, Identification, 19, Appendix F Lockwasher (2), Item 15, Appendix K	<i>General Safety Instructions</i> None	
<i>Personnel Required</i> MOS 63S, Heavy wheel vehicle mechanic		

a. Removal.

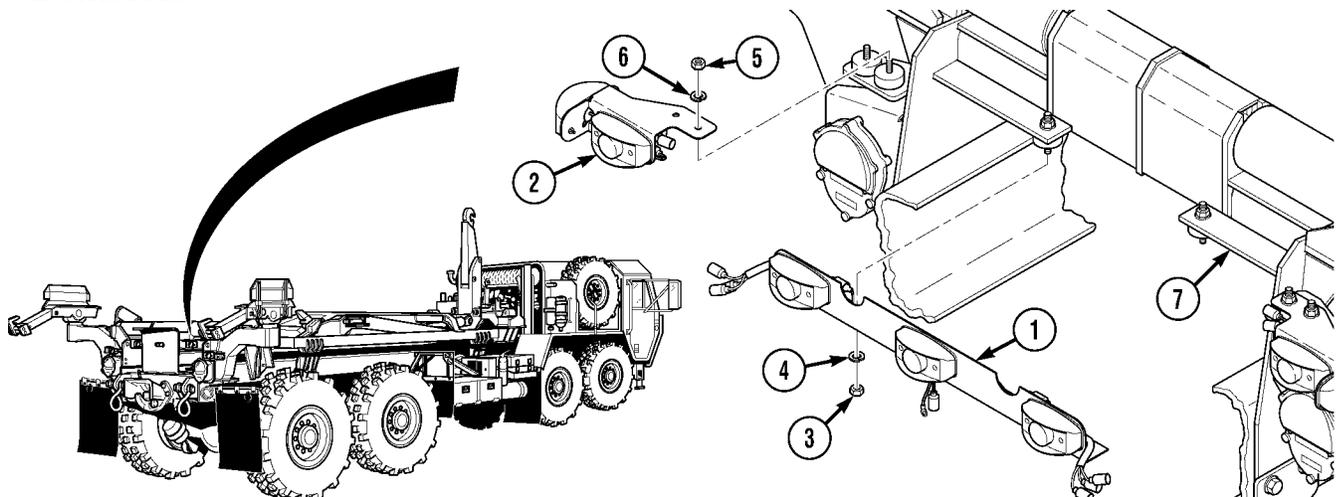

NOTE

- Tag and mark all wires before disconnecting.
- Cut wire ties as needed

- (1) Tag and disconnect wires to rear light bar (1), and clearance light (2).
- (2) Remove two nuts (3), lockwashers (4), and rear light bar (1). Discard lockwashers.

NOTE

Both clearance lights remove the same. Right side shown.

- (3) Remove two nuts (5), lockwashers (6), and right clearance light (2) from rear roller assembly (7). Discard lockwashers.

Organizational Maintenance Instructions (Cont)

4-43.1 CONTAINER HANDLING UNIT (CHU) REAR LIGHT BAR ASSEMBLY REPLACEMENT (CONT).

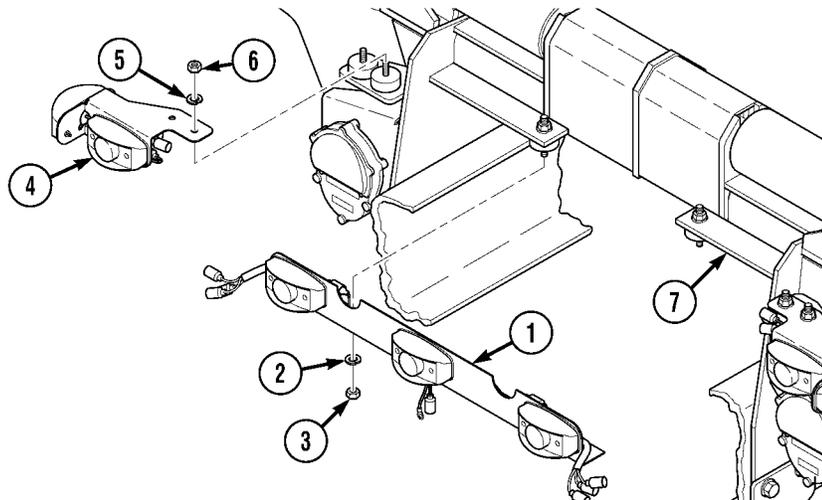

b. Installation.

- (1) Install rear light bar (1), two lockwashers (2), and nuts (3).
- (2) Connect wires to rear light bar (1).

NOTE

Both clearance lights install the same. Right side shown.

- (3) Install clearance light (4), two lockwashers (5), and two nuts (6) to rear roller assembly (7).
- (4) Connect wires to clearance light (4).

c. Follow-on Maintenance.

- (1) Install bumper stop stinger bracket (Para 4-49).
- (2) Remove wheel chocks (TM 9-2320-279-10).

END OF TASK

Organizational Maintenance Instructions (Cont)

4-44. REVERSE ALARM REPLACEMENT.							
This task covers:							
a. Removal	b. Installation						
c. Follow-on Maintenance							
INITIAL SETUP							
<i>Models</i> M1120	<i>Personnel Required</i> MOS 63S, Heavy wheel vehicle mechanic						
<i>Test Equipment</i> None	<i>References</i> None						
<i>Special Tools</i> Tool Kit, General Mechanic's: Automotive, Item 33, Appendix B	<i>Equipment Condition</i> <table border="0"> <tr> <td><i>TM or Para</i></td> <td><i>Condition Description</i></td> </tr> <tr> <td>TM 9-2320-279-10</td> <td>Engine OFF</td> </tr> <tr> <td>TM 9-2320-279-10</td> <td>Wheels chocked</td> </tr> </table>	<i>TM or Para</i>	<i>Condition Description</i>	TM 9-2320-279-10	Engine OFF	TM 9-2320-279-10	Wheels chocked
<i>TM or Para</i>	<i>Condition Description</i>						
TM 9-2320-279-10	Engine OFF						
TM 9-2320-279-10	Wheels chocked						
<i>Supplies</i> Cable Ties Item 4, Appendix F Tags, Identification Item 19, Appendix F Locknut (4) Item 5, Appendix K Locknut (2) Item 6, Appendix K	<i>Special Environmental Conditions</i> None <i>General Safety Instructions</i> None						

a. Removal.

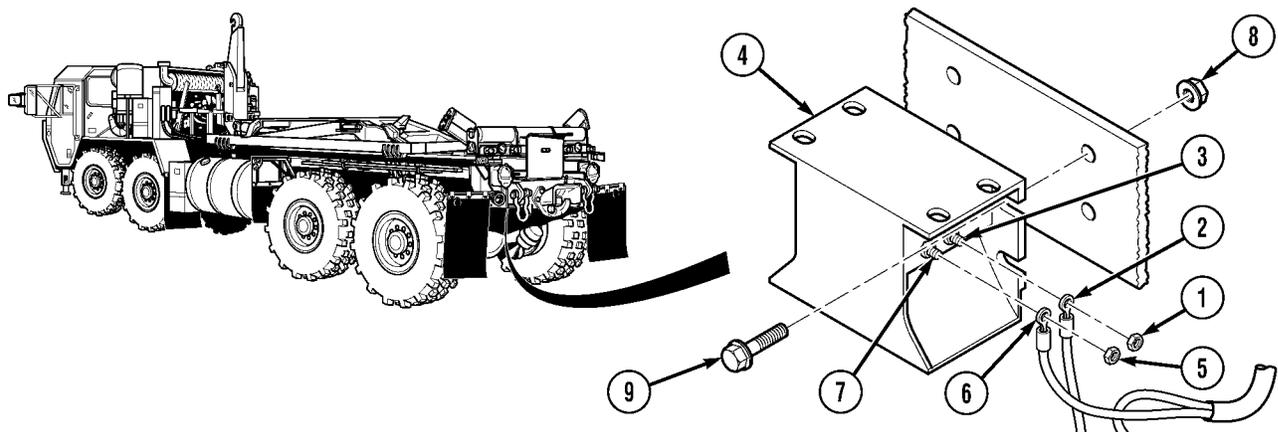

NOTE

- Tag and mark wires prior to removal.
- Remove cable ties as required.

- (1) Remove locknut (1) and wire 1665A (2) from positive stud (3) of reverse alarm (4). Discard locknut.
- (2) Remove locknut (5) and wire 1435 (6) from negative stud (7) of reverse alarm (4). Discard locknut
- (3) Remove four locknuts (8), four screws (9), and reverse alarm (4) from truck frame. Discard locknuts.

Organizational Maintenance Instructions (Cont)

4-44. REVERSE ALARM REPLACEMENT (CONT).

b. Installation.

- (1) Install reverse alarm (1), four screws (2), and four locknuts (3), on truck frame (4).

NOTE

Install cable ties as required.

- (2) Install wire 1435 (5) and locknut (6) on negative stud (7) of reverse alarm (1).
- (3) Install wire 1665A (8) and locknut (9) on positive stud (10) of reverse alarm (1).

- c. Follow-on Maintenance.** Remove wheel chocks (TM 9-2320-279-10).

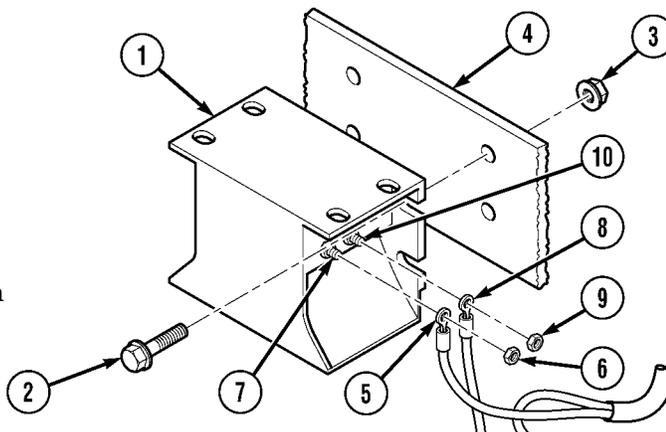

END OF TASK

Organizational Maintenance Instructions (Cont)

4-45. REVERSE ALARM SWITCH REPLACEMENT.	
This task covers:	
a. Removal	b. Installation
c. Follow-on Maintenance	
INITIAL SETUP	
<i>Models</i> M1120	<i>Personnel Required</i> MOS 63S, Heavy wheel vehicle mechanic
<i>Test Equipment</i> None	<i>References</i> None
<i>Special Tools</i> Tool Kit, General Mechanic's: Automotive, Item 33, Appendix B	<i>Equipment Condition</i> TM or Para <i>Condition Description</i> TM 9-2320-279-10 Engine OFF TM 9-2320-279-10 Wheels chocked
<i>Supplies</i> Cable Ties, Item 4, Appendix F Sealing Compound, Item 14, Appendix F Tags, Identification, Item 19, Appendix F	<i>Special Environmental Conditions</i> None <i>General Safety Instructions</i> None

a. Removal.

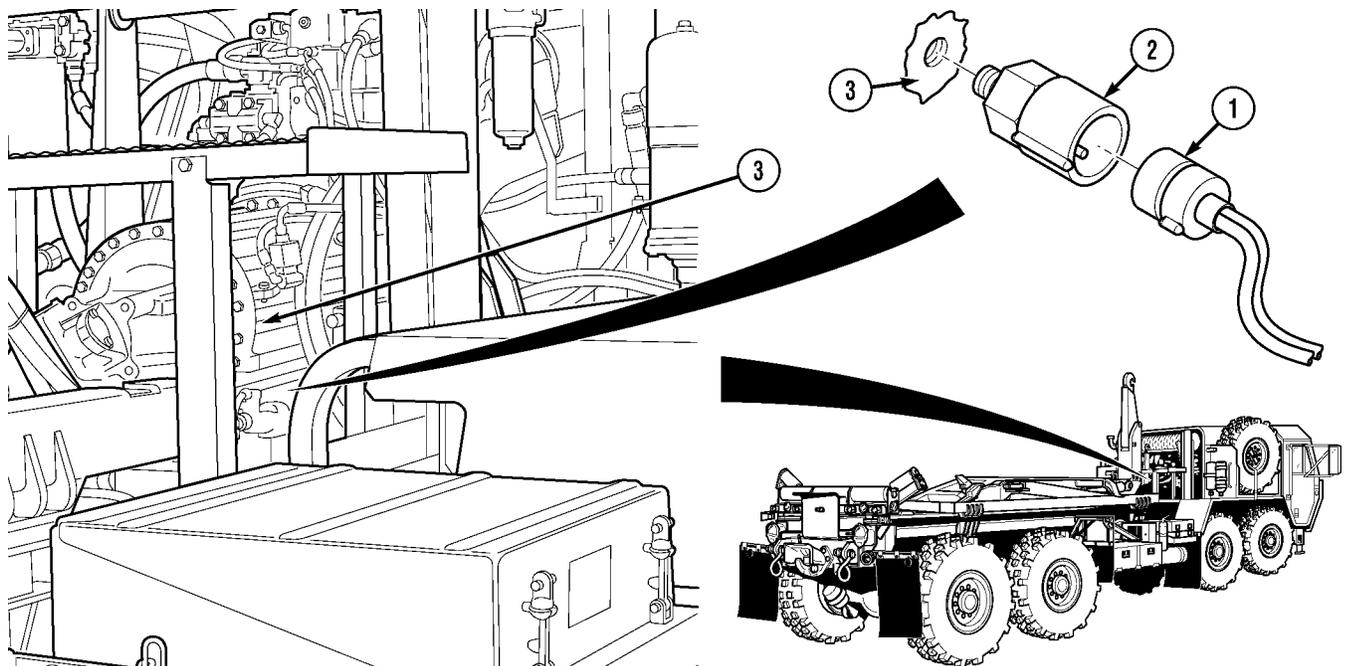

NOTE

- Mark all wires before disconnecting.
 - Cut cable ties as required.
- (1) Disconnect reverse alarm switch connector (1).
 (2) Remove reverse alarm switch (2) from transmission (3).

Organizational Maintenance Instructions (Cont)

4-45. REVERSE ALARM SWITCH REPLACEMENT (CONT).

b. Removal.

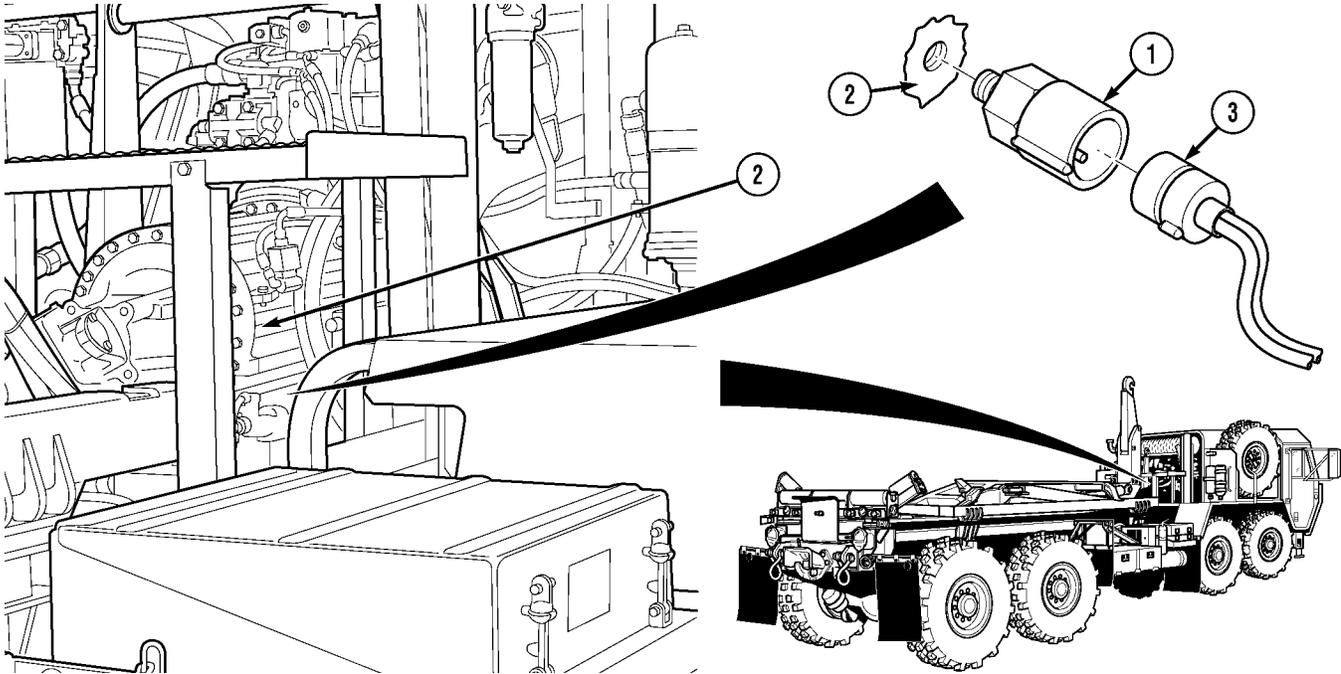

WARNING

Adhesives, solvents, and sealing compound can burn easily, can give off harmful vapors, and are harmful to skin and clothing. To avoid injury or death, keep away from open fire and use in a well-ventilated area. If adhesive, solvent, or sealing compound gets on skin or clothing, wash immediately with soap and water.

- (1) Apply sealing compound to threads of reverse alarm switch (1).
- (2) Install reverse alarm switch (1) in transmission (2).
- (3) Connect reverse alarm switch connector (3).

c. Follow-on Maintenance.

- (1) Check transmission fluid level (TM 9-2320-279-10).
- (2) Remove wheel chocks (TM 9-2320-279-10).

END OF TASK

Organizational Maintenance Instructions (Cont)

4-45.1 CONTAINER HANDLING UNIT (CHU) REAR LOCK LIMIT SWITCH REPLACEMENT/ADJUSTMENT.

This task covers:

- a. Removal
- b. Installation
- c. Adjustment
- d. Follow-on Maintenance

INITIAL SETUP

Models

M1120

Test Equipment

None

Special Tools

Tool Kit, General Mechanic's Automotive, Item 33, Appendix B

Supplies

Cable Ties, Item 4, Appendix F
Sealing Compound, Item 16, Appendix F

Personnel Required

MOS 63S, Heavy wheel vehicle mechanic

References

TM 9-2320-279-10
TM 43-0139

Equipment Condition

<i>TM or Para</i>	<i>Condition Description</i>
TM 9-2320-279-10	Engine OFF
TM 9-2320-279-10	Wheels chocked
TM 9-2320-279-20	Batteries disconnected

Special Environmental Conditions

None

General Safety Instructions

None

a. Removal.

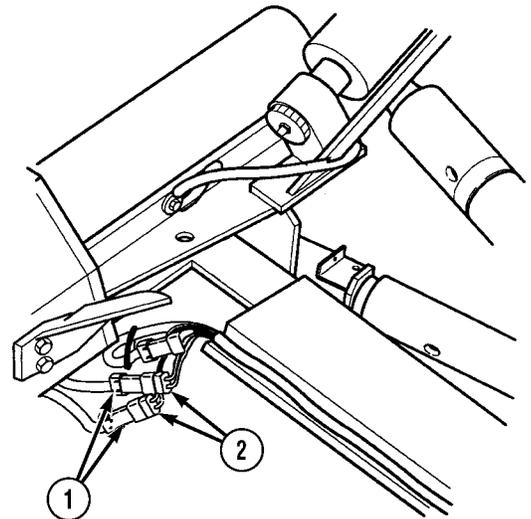
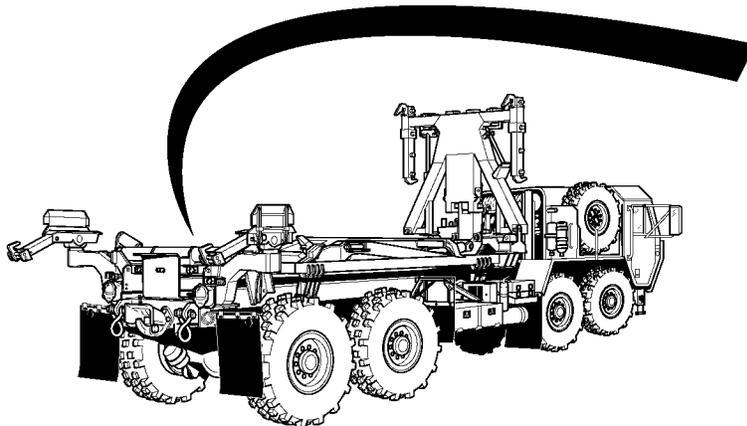

NOTE

- Note routing of switch wire harness prior to removal.
- Remove required cable ties.
- Left and right lock limit switches are identical. Right lock limit switch is shown.

(1) Disconnect MC190 connectors (1) from CHU wire harness connectors (2).

Organizational Maintenance Instructions (Cont)

4-45.1 CONTAINER HANDLING UNIT (CHU) REAR LOCK LIMIT SWITCH REPLACEMENT/ADJUSTMENT (CONT).

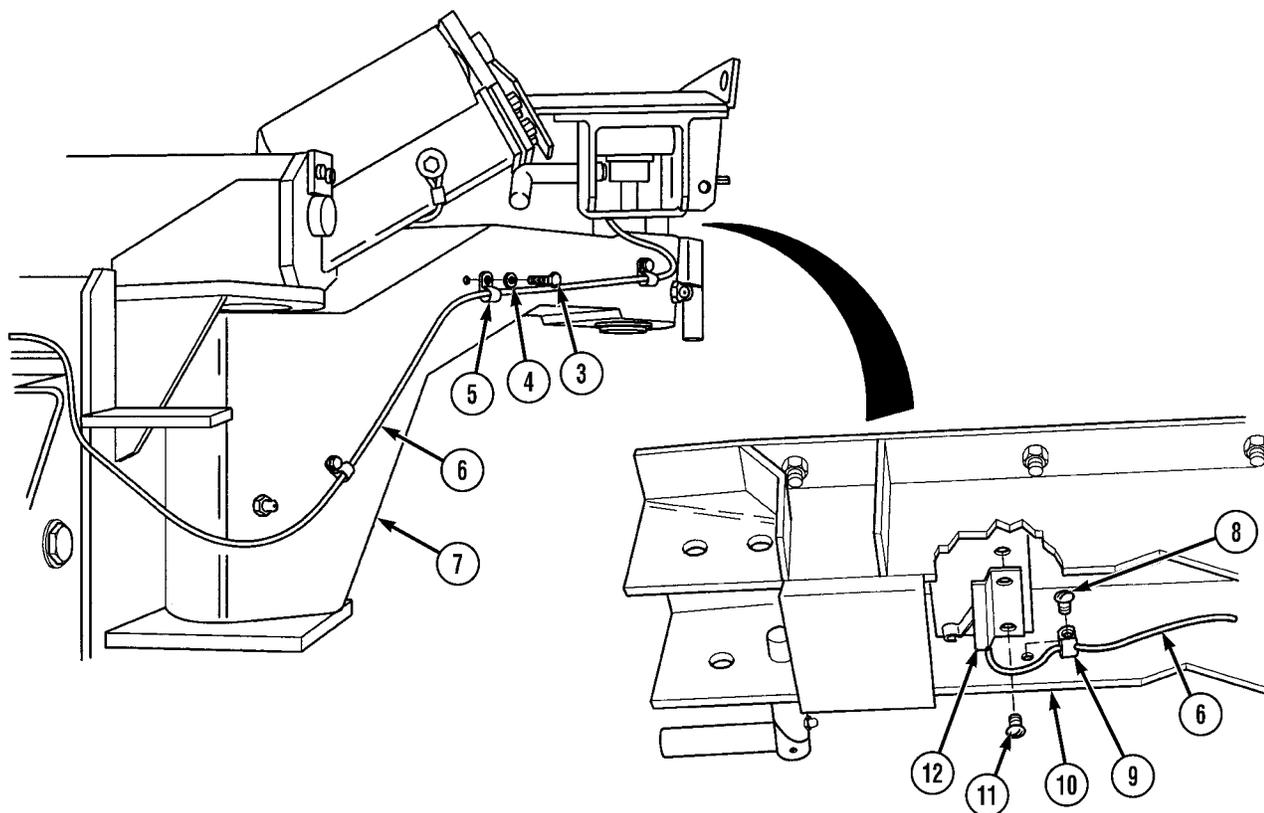

- (2) Remove three screws (3), washers (4), and cushion clips (5) from CHU wire harness (6) and arm assembly (7).
- (3) Remove screw (8) and cushion clip (9) from CHU wire harness (6) and slider (10).
- (4) Remove two screws (11) and lock limit switch (12) from slider (10).

Organizational Maintenance Instructions (Cont)

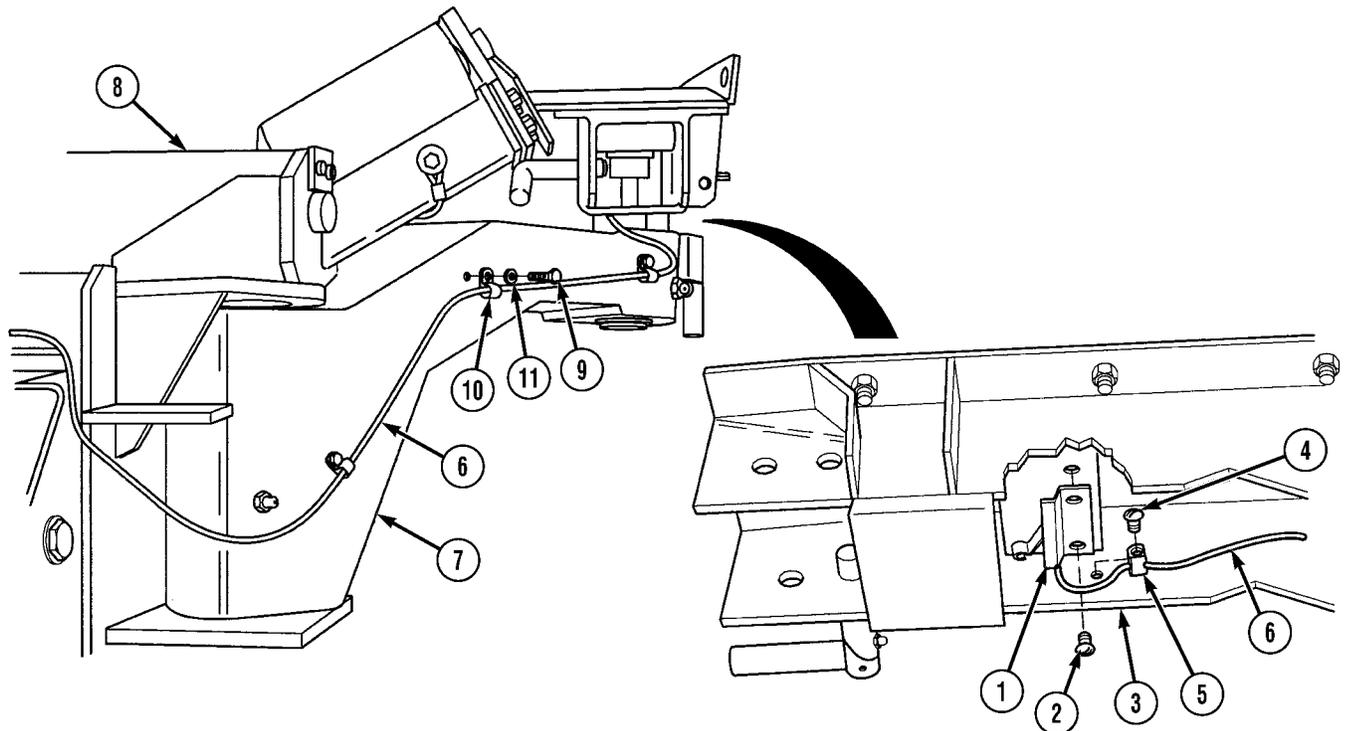
b. Installation.**NOTE**

- Left and right lock limit switches are identical. Right lock limit switch is shown.
- Install cable ties as required.

- (1) Position lock limit switch (1) with two screws (2) on slider (3). Do not tighten screws.

WARNING

Adhesives, solvents, and sealing compounds can burn easily, can give off harmful vapors, and are harmful to skin and clothing. To avoid injury or death, keep away from open fire and use in well-ventilated area. If adhesive, solvent, or sealing compound gets on skin or clothing, wash immediately with soap and water.

- (2) Apply sealing compound to threads of screw (4).
 (3) Position cushion clip (5) on CHU wire harness (6) and install on slider (3) with screw (4).
 (4) Stow right slider (Para 2-10.6).
 (5) Position CHU wire harness (6) along arm assembly (7) and under rear roller assembly (8).

WARNING

Adhesives, solvents, and sealing compounds can burn easily, can give off harmful vapors, and are harmful to skin and clothing. To avoid injury or death, keep away from open fire and use in well-ventilated area. If adhesive, solvent, or sealing compound gets on skin or clothing, wash immediately with soap and water.

- (6) Apply sealing compound to threads of three screws (9).

CAUTION

Leave enough slack in wire harness around pivot assembly to rotate slider without causing damage to harness.

- (7) Position three cushion clips (10) on CHU wire harness (6) and install on arm assembly (7) with three screws (9) and washers (11).

Organizational Maintenance Instructions (Cont)

4-45.1 CONTAINER HANDLING UNIT (CHU) REAR LOCK LIMIT SWITCH REPLACEMENT/ADJUSTMENT (CONT).

- (8) Connect MC190 connectors (12) to CHU wire harness connectors (13).

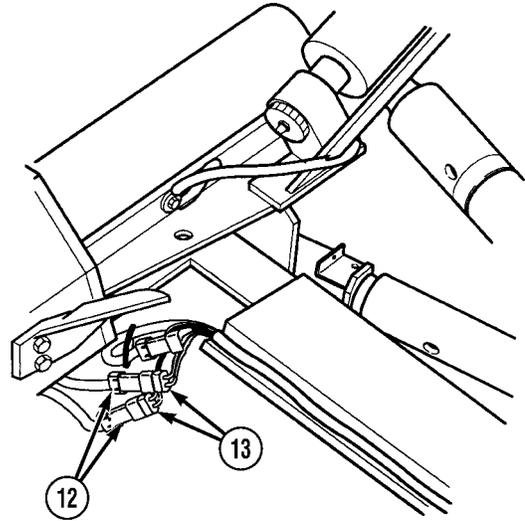

Organizational Maintenance Instructions (Cont)

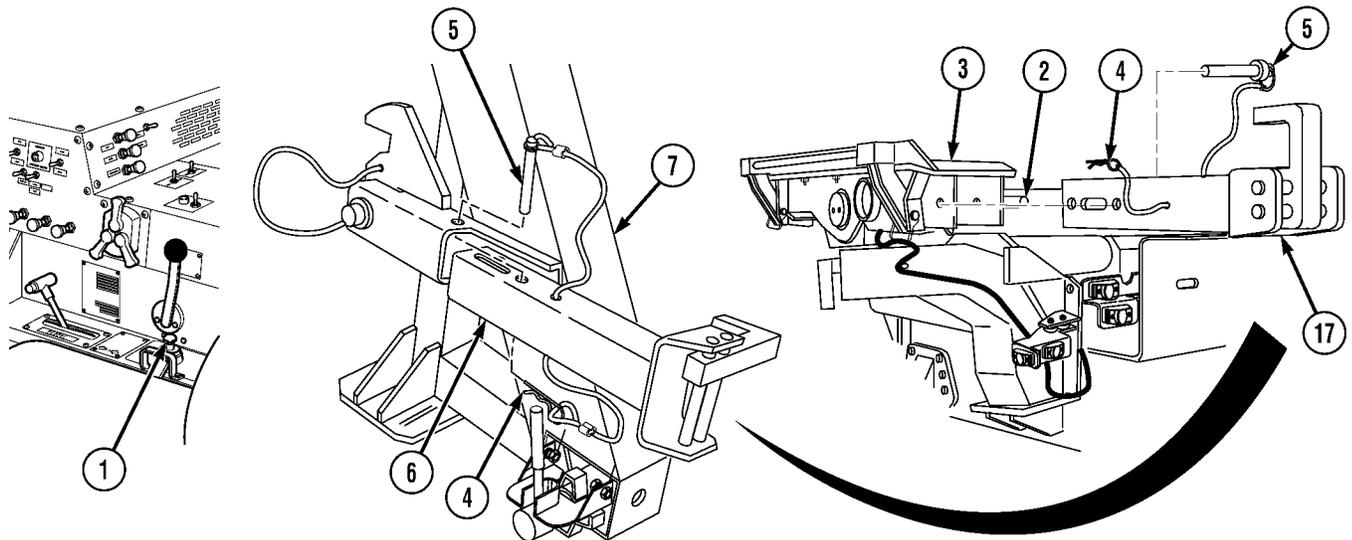
c. Adjustment.

- (1) Position slider in container mode (Para 2-10.1).
- (2) Raise LHS in AUTO mode approximately 18 in. (46 cm). Release joystick (1).

NOTE

- Both rear container locks are installed the same way. Left side shown.
- Lock handle is unlocked when facing front of slider.

- (3) Turn lock handle (2) on left rear slider assembly (3) forward to unlocked position.
- (4) Remove lock pin (4), pin (5), and rear container lock (6) from front lift adapter (7).
- (5) Position rear container lock (6) in locked position on left rear slider assembly (3) and install pin (5) and lock pin (4).
- (6) Turn lock handle (2) on left rear slider assembly (3) back to locked position.

Organizational Maintenance Instructions (Cont)

4-45.1 CONTAINER HANDLING UNIT (CHU) REAR LOCK LIMIT SWITCH REPLACEMENT/ADJUSTMENT (CONT).

NOTE

- LHS should not move when joystick is in UNLOAD position.
- If LHS does not move in UNLOAD position, go to step (14).
- If LHS moves in UNLOAD position, perform Steps (7) through (12).

(7) Move joystick (1) to UNLOAD position and check LHS for movement.

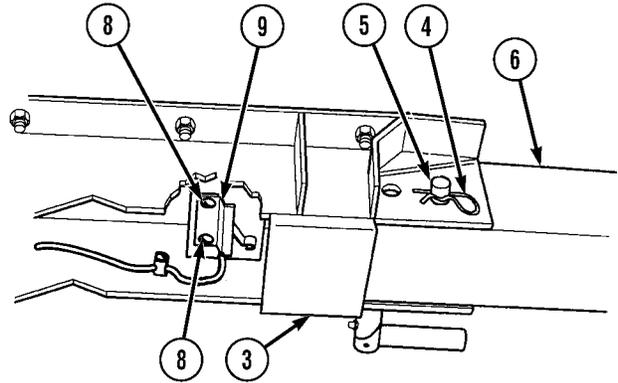
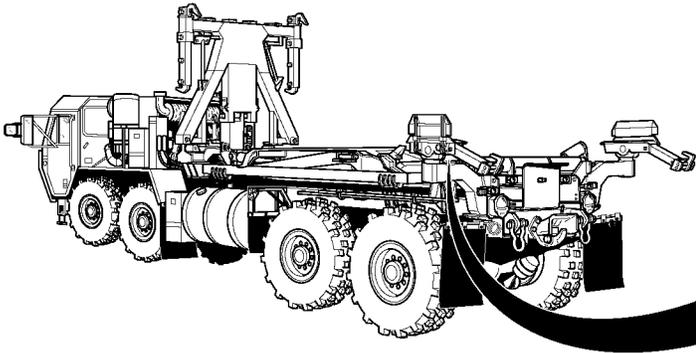
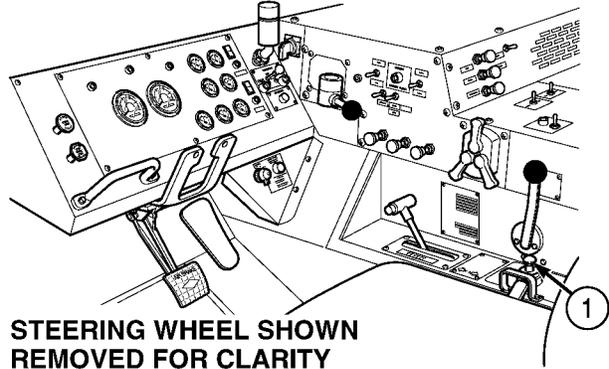

- (8) Position container lock (6) in locked position and install pin (5) and lock pin (4).
- (9) Remove two screws (8) from lock limit switch (9).

WARNING

Give off harmful vapors, and are harmful to skin and clothing. To avoid injury or death, keep away from open fire and use in well-ventilated area. If adhesive, solvent, or sealing compound gets on skin or clothing, wash immediately with soap and water.

- (10) Apply sealing compound to threads of two screws (8).
- (11) Position lock limit switch (9) with two screws (8) on slider (3).

NOTE

Lock limit switch is properly adjusted when lever is depressed and lock limit switch makes an audible click.

- (12) Position lock limit switch (9) against container lock (6) until audible click is heard, then tighten two screws (8).
- (13) Repeat step (7) to check LHS for movement.

Organizational Maintenance Instructions (Cont)

WARNING

Container lock could drop suddenly if not supported. Failure to comply may result in injury to personnel.

- (14) Support rear container lock (6) and remove lock pin (4) and pin (5) from rear container lock.

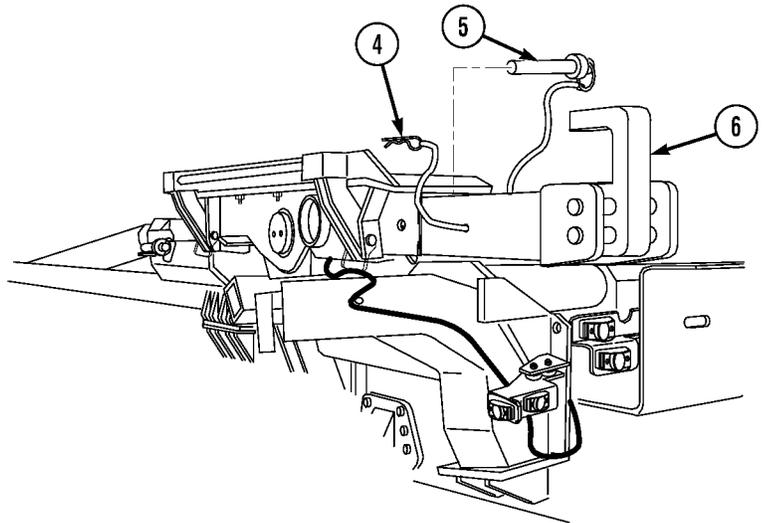

- (15) Position and lock rear container lock (6) in ready mode position by pulling out, rotating down, and inserting pin (5) and lock pin (4).
- (16) Repeat steps (3) through (15) for right side of truck.

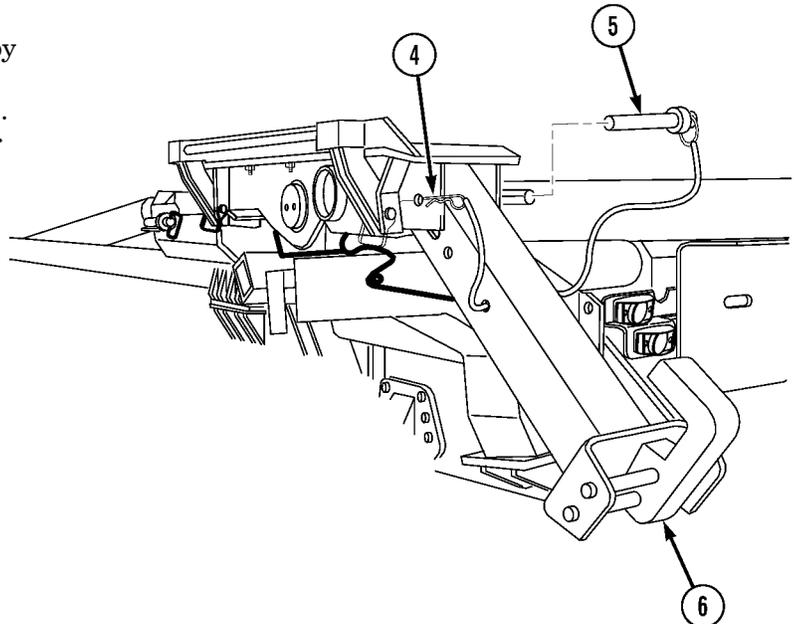
**d. Follow-on Maintenance.**

- (1) Connect batteries (TM 9-2320-279-20).
- (2) Remove wheel chocks (TM 9-2320-279-10).

END OF TASK

Organizational Maintenance Instructions (Cont)

4-46. HORIZONTAL ROLLER REPLACEMENT.		
This task covers:		
a. Removal	b. Installation	c. Follow-on Maintenance
INITIAL SETUP		
<i>Models</i> M1120	<i>References</i> None	
<i>Test Equipment</i> None	<i>Equipment Condition</i>	
<i>Special Tools</i> Tool Kit, General Mechanic's: Automotive, Item 33, Appendix B Lifting Device, Minimum Capacity 375 lbs (170 kg)	TM 9-2320-279-10	Engine OFF
	TM 9-2320-279-10	Wheels chocked
	Para 4-47	Angled rollers removed
<i>Supplies</i> Lockwasher, Item 23, Appendix K Lockwasher (2), Item 18, Appendix K	Para 4-48	Rear roller assembly removed
	<i>Special Environmental Conditions</i> None	
<i>Personnel Required</i> MOS 63S, Heavy wheel vehicle mechanic	<i>General Safety Instructions</i> None	

a. Removal.

WARNING

Rear roller assembly weighs 375 lbs. (170 kg). Attach suitable lifting device prior to removal to prevent possible injury to personnel.

NOTE

Both right and left hand horizontal rollers are removed the same way. Right horizontal roller is shown.

- (1) Using lifting device, place rear roller assembly (1) on clean work surface.

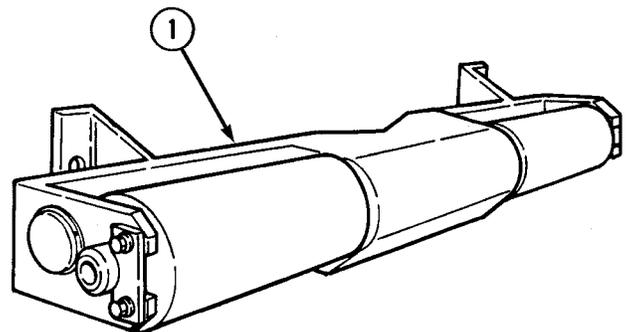

Organizational Maintenance Instructions (Cont)

4-46. HORIZONTAL ROLLER REPLACEMENT (CONT).

- (2) Remove lube fitting (2), bend lockwasher tab out of nut slot and remove nut (3), lockwasher (4), and thrust washer (5) from roller (6) at underside of roller assembly (1). Discard lockwasher.

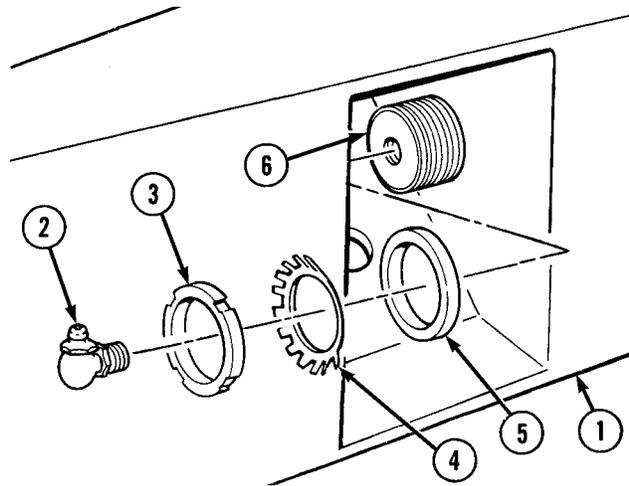

- (3) Remove two screws (7), lockwashers (8), lockplate (9), and lube fitting (10) from roller assembly (1). Discard lockwashers.

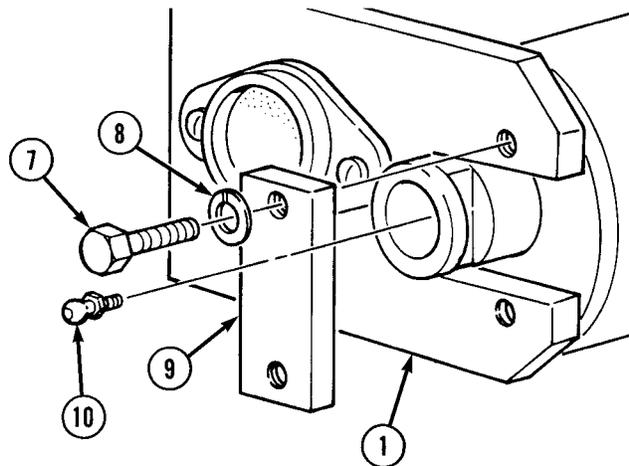

- (4) Attach lifting device to rear roller (6).

WARNING

Horizontal roller weighs 75 lbs (34 kg). Attach suitable lifting device prior to removal to prevent possible injury to personnel.

- (5) Using lifting device, remove roller (6) from roller assembly (1).
 (6) Remove lifting device.

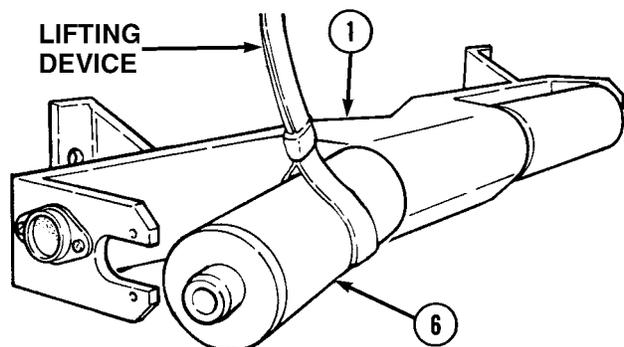

Organizational Maintenance Instructions (Cont)

b. Installation.

- (1) Attach lifting device to roller (1).

WARNING

Horizontal roller weighs 75 lbs (34 kg). Attach suitable lifting device prior to installation to prevent possible injury to personnel.

- (2) Using lifting device, position roller (1) in roller assembly (2).

- (3) Install lockplate (3), two lockwashers (4), two screws (5), and lube fitting (6) in roller assembly (2).

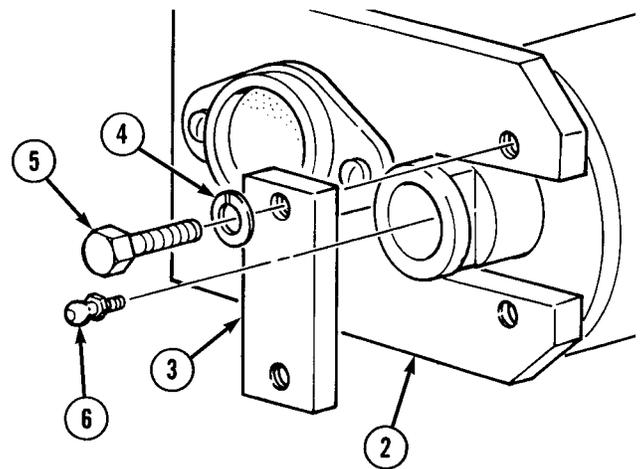
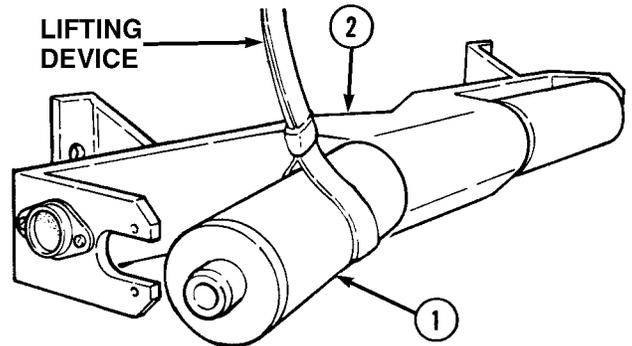

NOTE

Nut is installed properly when nut is tightened and roller does not bind.

- (4) Install thrust washer (7), lockwasher (8), nut (9), and lube fitting (10) on roller (1). Tighten nut.
- (5) Bend tab of lockwasher (8) into slot of nut (9).
- (6) Remove lifting device from roller (1).

c. Follow-on Maintenance.

- (1) Install rear roller assembly (Para 4-48).
- (2) Install angled rollers (Para 4-47).
- (3) Lubricate roller assembly (Para 3-2).
- (4) Remove wheel chocks (TM 9-2320-279-10).

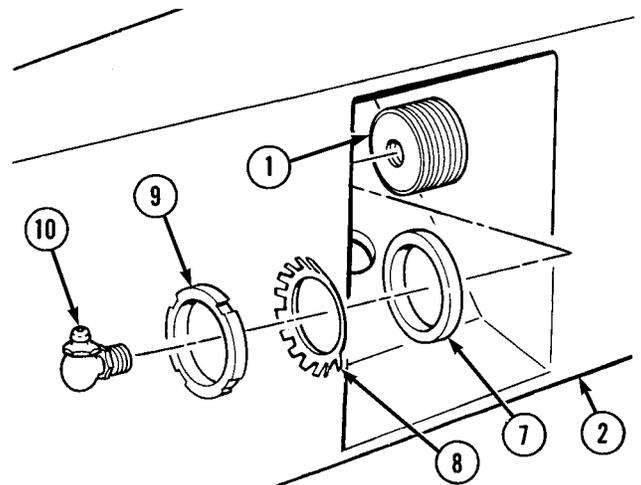

END OF TASK

Organizational Maintenance Instructions (Cont)

4-47. ANGLED ROLLER REPLACEMENT.								
This task covers:								
a. Removal	b. Installation	c. Follow-on Maintenance						
INITIAL SETUP								
<i>Models</i> M1120	<i>References</i> None							
<i>Test Equipment</i> None	<i>Equipment Condition</i> <table border="0"> <tr> <td><i>TM or Para</i></td> <td><i>Condition Description</i></td> </tr> <tr> <td>TM 9-2320-279-10</td> <td>Engine OFF</td> </tr> <tr> <td>TM 9-2320-279-10</td> <td>Wheels chocked</td> </tr> </table>		<i>TM or Para</i>	<i>Condition Description</i>	TM 9-2320-279-10	Engine OFF	TM 9-2320-279-10	Wheels chocked
<i>TM or Para</i>	<i>Condition Description</i>							
TM 9-2320-279-10	Engine OFF							
TM 9-2320-279-10	Wheels chocked							
<i>Special Tools</i> Tool Kit, General Mechanic's: Automotive, Item 33, Appendix B	<i>Special Environmental Conditions</i> None							
<i>Supplies</i> Lockwasher (4), Item 19, Appendix K Lockwasher (2), Item 18, Appendix K Lockwasher, Item 23, Appendix K	<i>General Safety Instructions</i> None							
<i>Personnel Required</i> MOS 63S, Heavy wheel vehicle mechanic								

a. Removal.

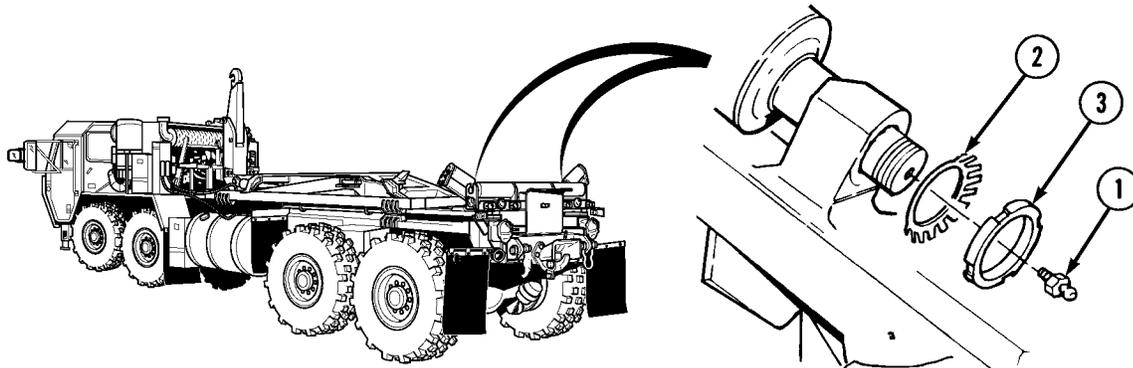

(1) Remove lube fitting (1).

NOTE

Both left and right hand angled rollers are removed the same way. Left hand roller is shown.

(2) Bend tab of lockwasher (2) out of nut (3) slot.

(3) Remove nut (3) and lockwasher (2). Discard lockwasher.

Organizational Maintenance Instructions (Cont)

- (4) Remove lube fitting (4), two screws (5), lockwashers (6), bracket (7), lockplate (8), four screws (9), lockwashers (10), and endplate (11). Discard lockwashers.

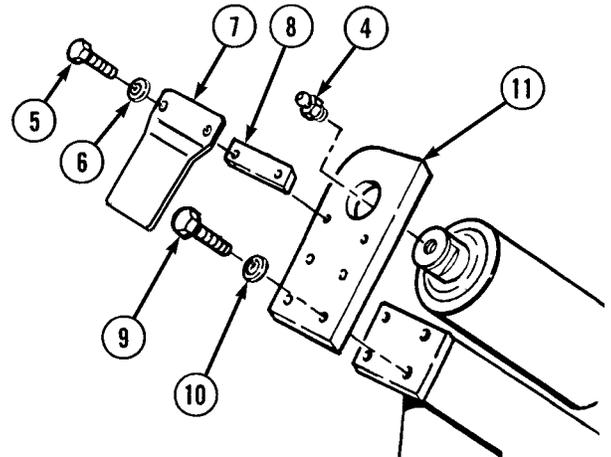

- (5) Using a soft faced hammer, remove roller (12) from roller assembly (13).

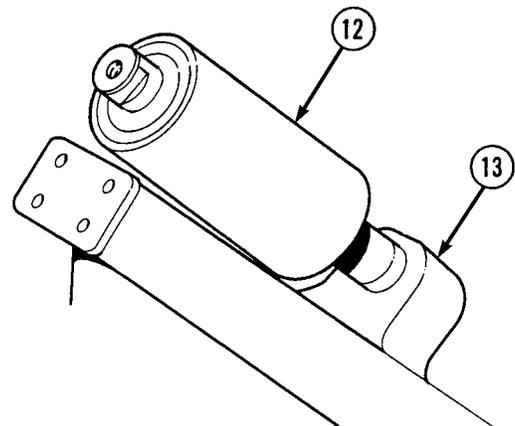

b. Installation.

- (1) Position roller (1) in roller assembly (2).

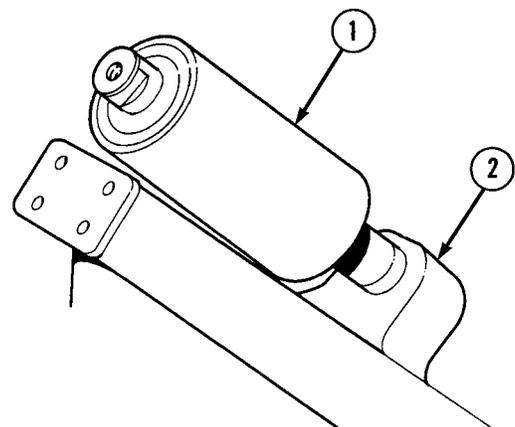

Organizational Maintenance Instructions (Cont)

4-47. ANGLED ROLLER REPLACEMENT (CONT).

- (2) Install endplate (3), four lockwashers (4) and screws (5).
- (3) Install lockplate (6), bracket (7), two lockwashers (8), and screws (9).
- (4) Install lube fitting (10) in roller assembly (1).

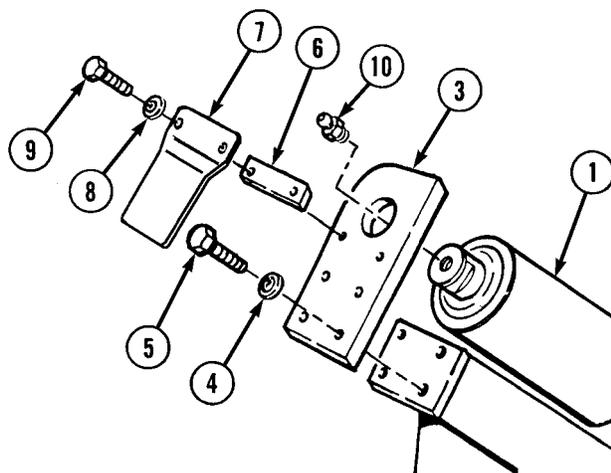

- (5) Install lockwasher (11), nut (12), and grease fitting (13). Tighten nut.
- (6) Bend tab of lockwasher (11) into slot of nut (12).

c. Follow-on Maintenance.

- (1) Lubricate rear rollers (Para 3-2).
- (2) Remove wheel chocks (TM 9-2320-279-10).

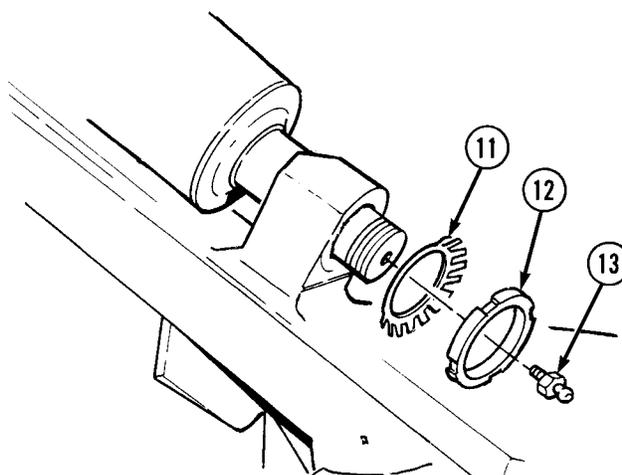

END OF TASK

Organizational Maintenance Instructions (Cont)

4-48. REAR ROLLER ASSEMBLY REPLACEMENT.	
This task covers:	
a. Removal	b. Installation
c. Follow-on Maintenance	
INITIAL SETUP	
<i>Models</i> M1120	<i>Personnel Required</i> MOS 63S, Heavy wheel vehicle mechanic (2)
<i>Test Equipment</i> None	<i>References</i> None
<i>Special Tools</i> Tool Kit, General Mechanic's: Automotive, Item 33, Appendix B Multiplier, Torque, Item 15, Appendix B Socket Set, 3/4 in., Item 23, Appendix B Wrench, Combination 1-1/8 in., Item 37, Appendix B Lifting Device, Minimum Capacity 375 lbs (170 kg)	<i>Equipment Condition</i> <i>TM or Para</i> <i>Condition Description</i> TM 9-2320-279-10 Engine OFF TM 9-2320-279-10 Wheels chocked
<i>Supplies</i> Adhesive, Item 1, Appendix F Locknut (6), Item 2, Appendix K	<i>Special Environmental Conditions</i> None <i>General Safety Instructions</i> None

a. Removal.

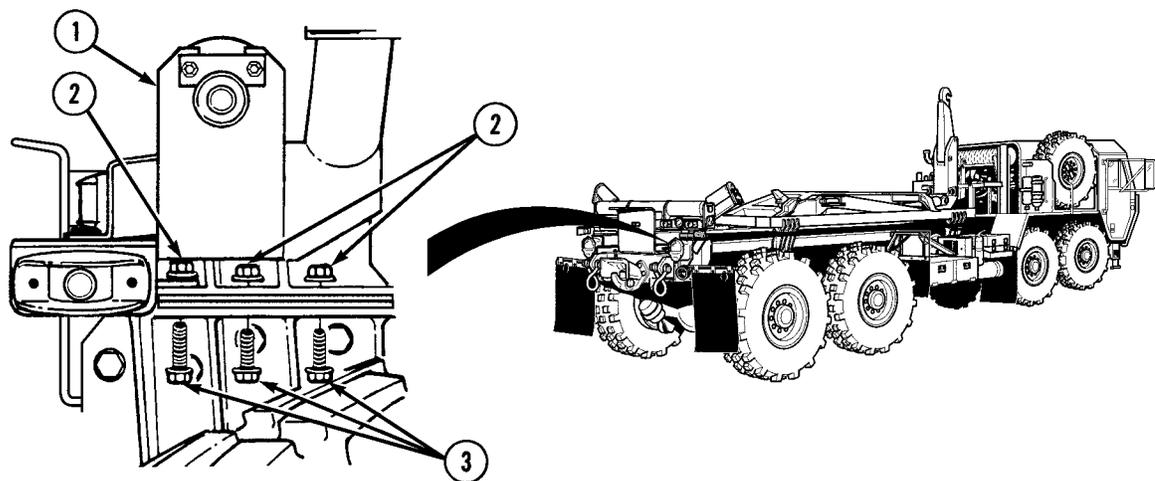

WARNING

Rear roller assembly weighs 375 lbs (170 kg). Attach suitable lifting device prior to removal or installation to prevent possible injury to personnel.

- (1) Attach lifting device to rear roller assembly (1).
- (2) Remove six locknuts (2) and six screws (3) from rear roller assembly (1). Discard locknuts.

Organizational Maintenance Instructions (Cont)

4-48. REAR ROLLER ASSEMBLY REPLACEMENT (CONT).

CAUTION

To remove or install rear roller assembly, it is necessary to slide the assembly under rear marker light bracket. Be careful not to damage marker light wiring.

- (3) Soldier A guides rear roller assembly (1) up and off of truck.
- (4) Remove lifting device from rear roller assembly (1).
- (5) Remove four spacers (4).

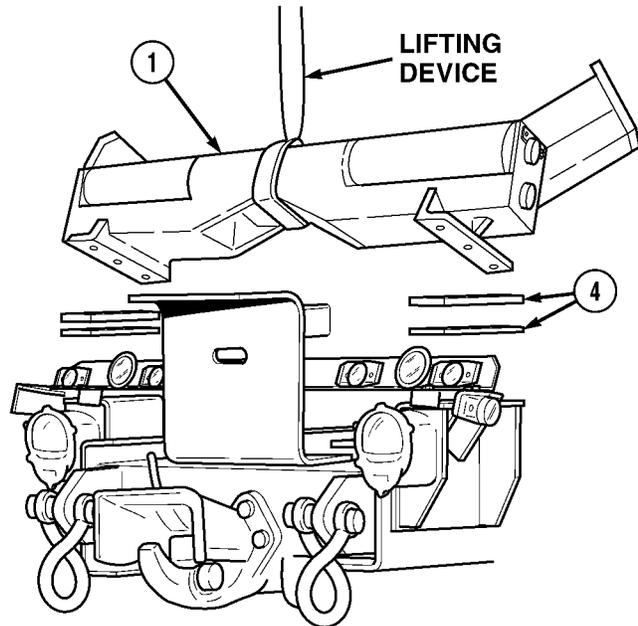

b. Installation.

- (1) Install four spacers (1).

WARNING

Rear roller assembly weighs 375 lbs (170 kg). Attach suitable lifting device prior to removal or installation to prevent possible injury to personnel.

- (2) Attach lifting device to rear roller assembly (2).

CAUTION

To remove or install rear roller assembly, it is necessary to slide the assembly under rear marker light bracket. Be careful not to damage marker light wiring.

- (3) Soldier A lowers rear roller assembly (2) onto truck.

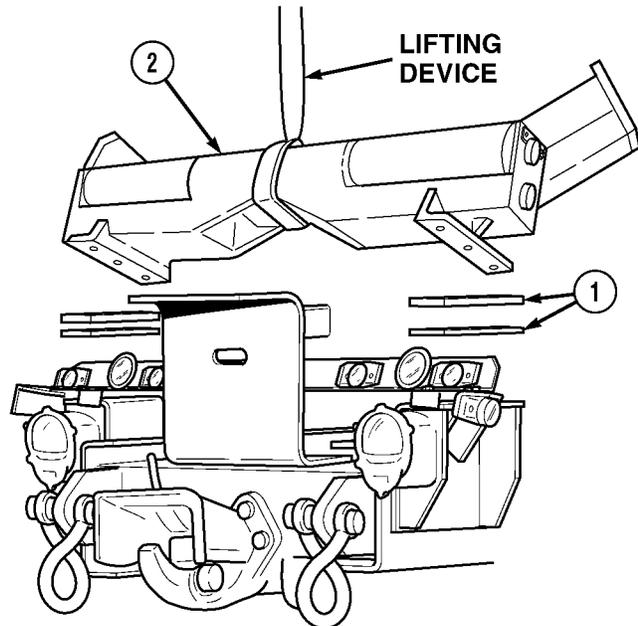

Organizational Maintenance Instructions (Cont)

WARNING

Adhesives, solvents, and sealing compounds can burn easily, can give off harmful vapors, and are harmful to skin and clothing. To avoid injury or death, keep away from open fire and use in a well-ventilated area. If adhesive, solvent, or sealing compound gets on skin or clothing, wash immediately with soap and water.

- (4) Coat threads of six screws (3) with sealing compound.

NOTE

Rear screws also go through rear light bar assembly mounting brackets.

- (5) Install six screws (3) and six locknuts (4) in rear roller assembly (2).
- (6) Remove lifting device from rear roller assembly (2).

c. Follow-on Maintenance.

- (1) Lubricate roller (Para 3-2).
- (2) Remove wheel chocks (TM 9-2320-279-10).

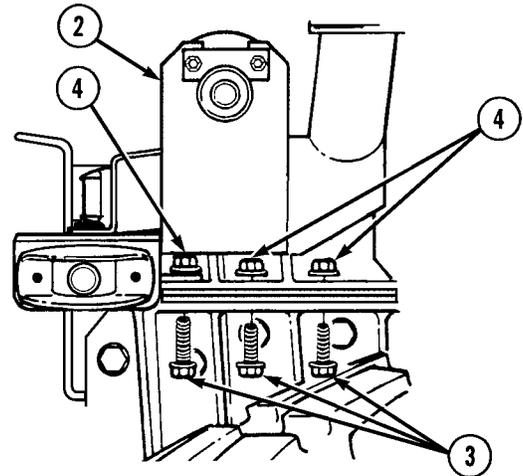

END OF TASK

Organizational Maintenance Instructions (Cont)

4-49. BUMPER STOP STINGER BRACKET REPLACEMENT.								
This task covers:								
a. Removal	b. Installation	c. Follow-on Maintenance						
INITIAL SETUP								
<i>Models</i> M1120	<i>References</i> None							
<i>Test Equipment</i> None	<i>Equipment Condition</i> <table border="0"> <tr> <td><i>TM or Para</i></td> <td><i>Condition Description</i></td> </tr> <tr> <td>TM 9-2320-279-10</td> <td>Engine OFF</td> </tr> <tr> <td>TM 9-2320-279-10</td> <td>Wheels chocked</td> </tr> </table>		<i>TM or Para</i>	<i>Condition Description</i>	TM 9-2320-279-10	Engine OFF	TM 9-2320-279-10	Wheels chocked
<i>TM or Para</i>	<i>Condition Description</i>							
TM 9-2320-279-10	Engine OFF							
TM 9-2320-279-10	Wheels chocked							
<i>Special Tools</i> Tool Kit, General Mechanic's: Automotive, Item 33, Appendix B	<i>Special Environmental Conditions</i> None							
<i>Supplies</i> Locknuts (6), Item 2, Appendix K Locknuts (6), Item 3, Appendix K	<i>General Safety Instructions</i> None							
<i>Personnel Required</i> MOS 63S, Heavy wheel vehicle mechanic								

a. Removal.

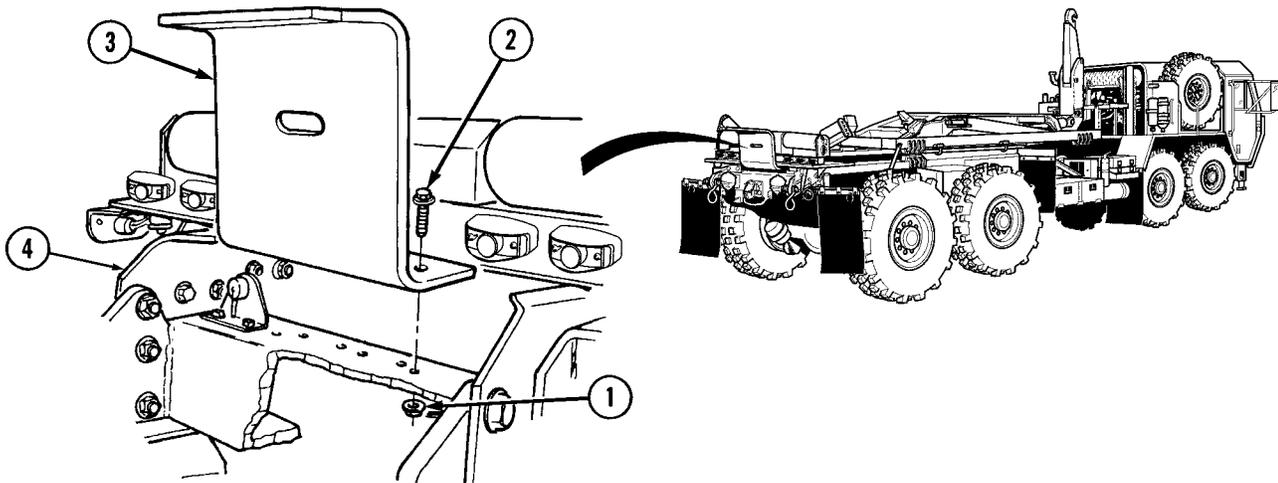

- (1) Remove six locknuts (1) and screws (2). Discard locknuts.
- (2) Remove bumper stop stinger bracket (3) from rear crossmember (4).

Organizational Maintenance Instructions (Cont)**b. Installation.**

- (1) Install bumper stop stinger bracket (1) on top of rear crossmember (2) with six screws (3) and locknuts (4).
- (2) Tighten locknuts (4) on screws (3).

c. Follow-on Maintenance. Remove wheel chocks (TM 9-2320-279-10).

END OF TASK

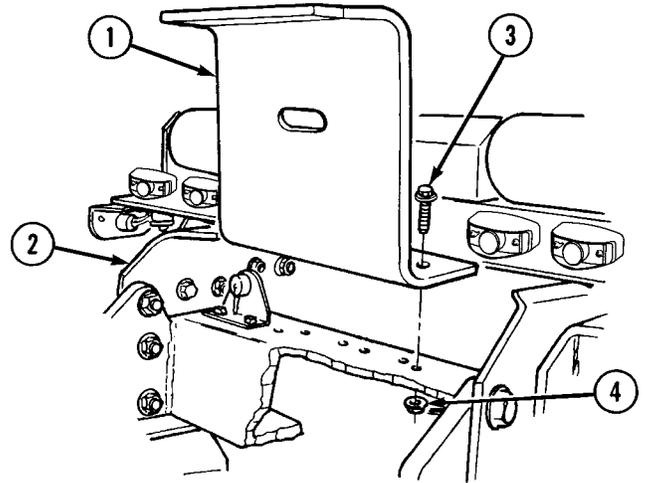

Organizational Maintenance Instructions (Cont)

4-50. REAR FENDER REPLACEMENT.		
This task covers:		
a. Removal	b. Installation	c. Follow-on Maintenance
INITIAL SETUP		
<i>Models</i>	<i>References</i>	
M1120	None	
<i>Test Equipment</i>	<i>Equipment Condition</i>	
None	<i>TM or Para</i>	<i>Condition Description</i>
<i>Special Tools</i>	TM 9-2320-279-10	Engine OFF
Tool Kit, General Mechanic's: Automotive, Item 33, Appendix B	TM 9-2320-279-10	Wheels chocked
	TM 9-2320-279-20	Disconnect batteries
	Para 4-42	Rear fender side marker lamp removed
<i>Supplies</i>	Para 4-51	Center mud flap removed
Locknut (2) Item 1, Appendix K	<i>Special Environmental Conditions</i>	
Locknut (3) Item 2, Appendix K	None	
Locknut (4) Item 4, Appendix K	<i>General Safety Instructions</i>	
Screw, Tapping, Item 43, Appendix K	None	
<i>Personnel Required</i>		
MOS 63S, Heavy wheel vehicle mechanic		

Organizational Maintenance Instructions (Cont)

a. Removal.

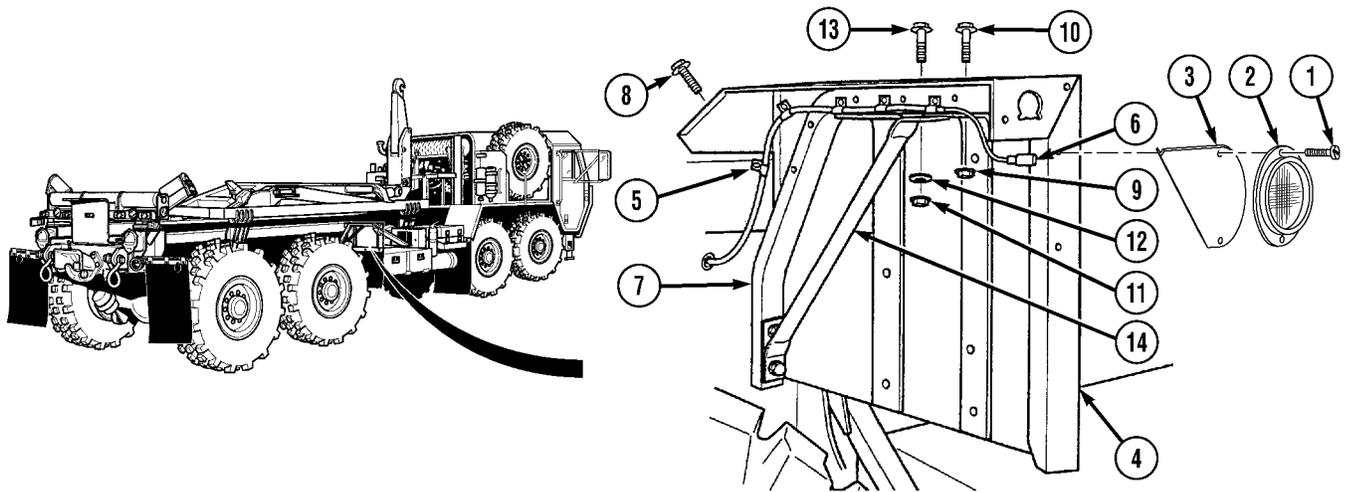

NOTE

- Both rear fenders are removed the same way. The right fender is shown.
- Mark all wires before disconnecting.

- (1) Remove two screws (1), reflector (2), and reflector bracket (3) from fender (4).
- (2) Remove six push clips (5) and marker lamp wiring harness (6) from fender support arm (7).
- (3) Remove self-tapping screw (8) from fender support arm (7). Discard self-tapping screw.
- (4) Remove two locknuts (9) and screws (10) from fender support arm (7). Discard locknuts.
- (5) Remove locknut (11), washer (12), and screw (13) from fender support arm (7) and fender brace (14). Discard locknut.
- (6) Remove rear fender (4) from fender support arm (7).
- (7) Remove four locknuts (15), screws (16), and two braces (17) from rear fender (4). Discard locknuts.

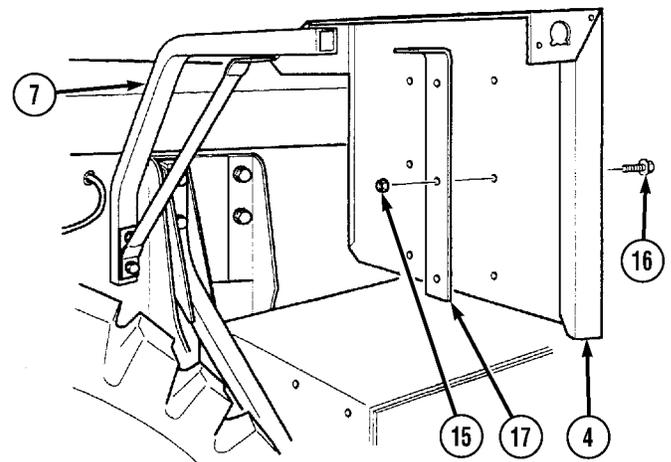

Organizational Maintenance Instructions (Cont)

4-50. REAR FENDER REPLACEMENT (CONT).

- (8) With the aid of an assistant, remove locknut (18), screw (19), and brace (20) from truck frame (21). Discard locknut.
- (9) With the aid of an assistant, remove locknut (22), screw (23), spacer (24), and fender support arm (7) from truck frame (21). Discard locknut.

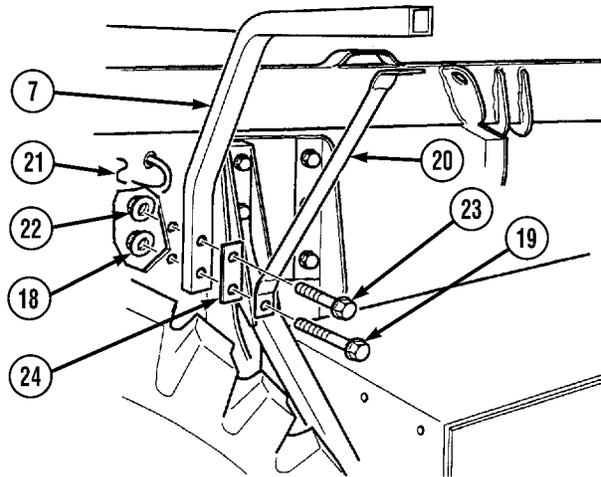

b. Installation.

- (1) With the aid of an assistant, position fender support arm (1), spacer (2), screw (3), and locknut (4) on truck frame (5).
- (2) With the aid of an assistant, install brace (6), screw (7), and locknut (8) in truck frame (5).
- (3) With the aid of an assistant, tighten locknut (4) on screw (3).

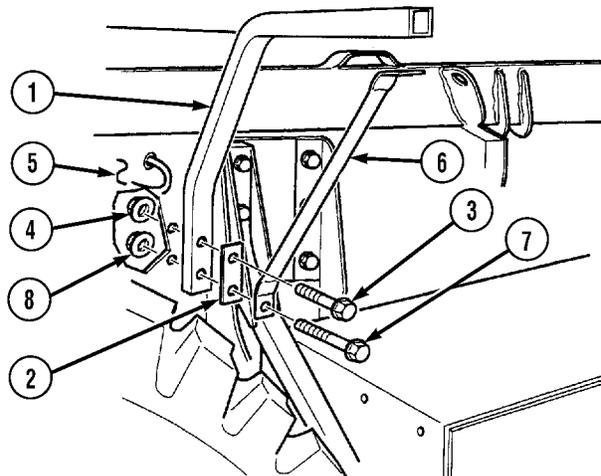

- (4) Install two braces (9) on rear fender (10) using four screws (11) and locknuts (12).
- (5) Position rear fender (10) on fender support arm (1).

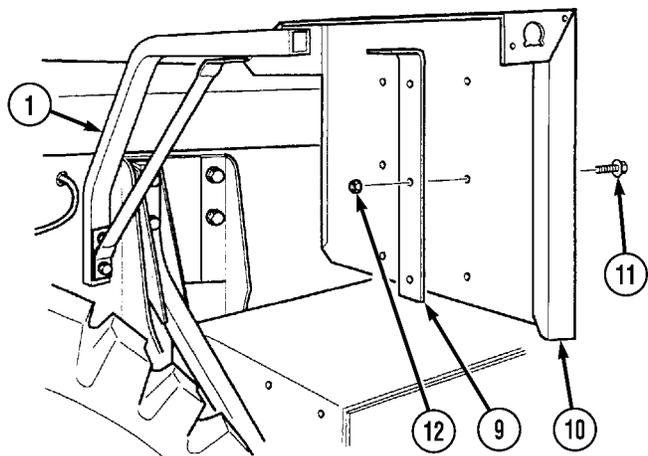

Organizational Maintenance Instructions (Cont)

- (6) Position screw (13), washer (14), and locknut (15) in fender support arm (1) and fender brace (16).
- (7) Install two screws (17) and locknuts (18) in fender support arm (1).
- (8) Tighten locknut (15) on screw (13).
- (9) Install self-tapping screw (19) in fender support arm (1).

NOTE

Push clips are properly installed when lock button is pushed in after installation.

- (10) Install marker lamp wiring harness (20) and six push clips (21) on fender support arm (1).
- (11) Install reflector bracket (22), reflector (23), and two screws (24).

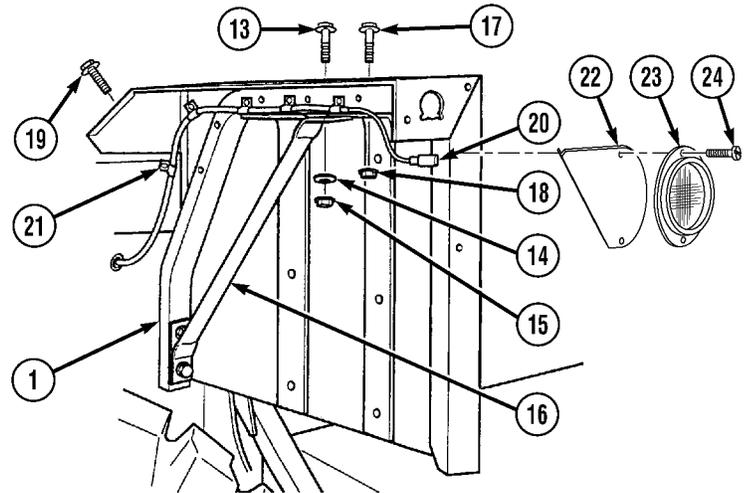

c. Follow-on Maintenance.

- (1) Install rear fender side marker lamp (Para 4-42).
- (2) Install center mud flap (Para 4-51).
- (3) Connect batteries (TM 9-2320-279-20).
- (4) Remove wheel chocks (TM 9-2320-279-10).

END OF TASK

Organizational Maintenance Instructions (Cont)

4-51. CENTER MUD FLAP REPLACEMENT.		
This task covers:		
a. Removal	b. Installation	c. Follow-on Maintenance
INITIAL SETUP		
<i>Models</i> M1120	<i>References</i> None	
<i>Test Equipment</i> None	<i>Equipment Condition</i> TM or Para Condition Description TM 9-2320-279-10 Engine OFF. TM 9-2320-279-10 Wheels chocked.	
<i>Special Tools</i> Tool Kit, General Mechanic's: Automotive, Item 33, Appendix B	<i>Special Environmental Conditions</i> None	
<i>Supplies</i> Locknut (3) Item 2, Appendix K	<i>General Safety Instructions</i> None	
<i>Personnel Required</i> MOS 63S, Heavy wheel vehicle mechanic		

NOTE

Procedures are identical for both sides of truck. Left side shown.

a. Remove. Remove three locknuts (1), screws (2), clamping plate (3), and mud flap (4) from fender assembly (5). Discard locknuts.

b. Installation. Install mud flap (4) on fender assembly (5) with clamping plate (3), three screws (2), and locknuts (1).

c. Follow-on Maintenance. Remove wheel chocks (TM 9-2320-279-10).

END OF TASK

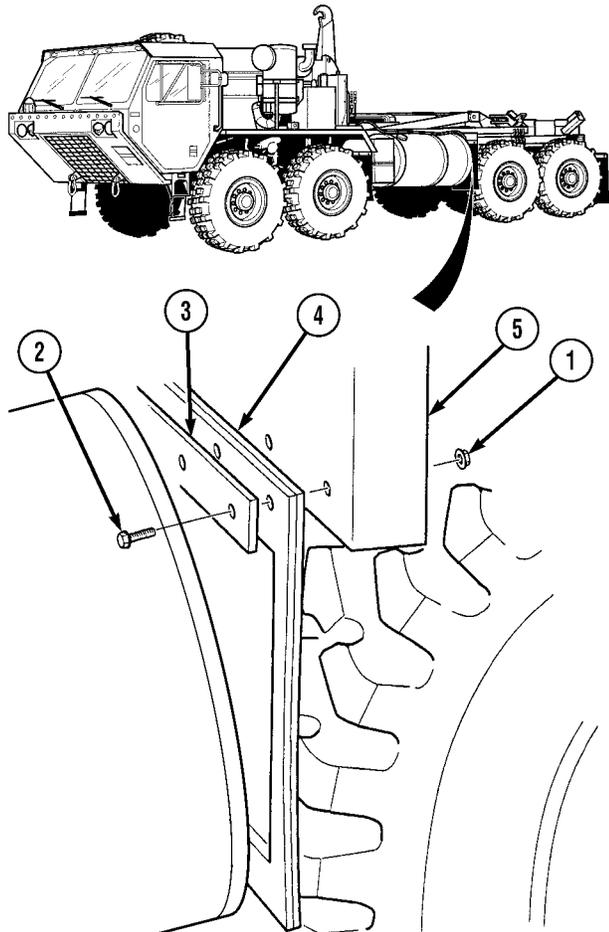

Organizational Maintenance Instructions (Cont)

4-51.1 LADDER BRACKET REPLACEMENT.

This task covers:

a. Removal

b. Installation

c. Follow-on Maintenance

INITIAL SETUP

Models

M1120

References

None

Test Equipment

None

Equipment Condition

TM or Para

Condition Description

Special Tools

Tool Kit, General Mechanic's: Automotive, Item 33, Appendix B

TM 9-2320-279-10 Engine OFF

TM 9-2320-279-10 Wheels chocked

Supplies

Locknuts (2), Item 3, Appendix K

Special Environmental Conditions

None

Personnel Required

MOS 63S, Heavy wheel vehicle mechanic

General Safety Instructions

None

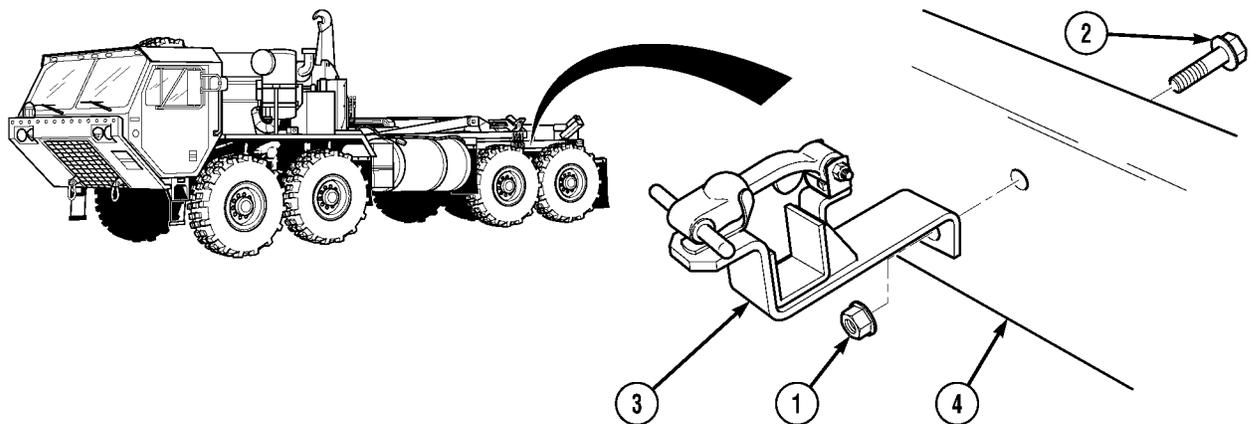

a. Removal.

NOTE

There are two ladder bracket assemblies on the left side of frame. Replacement procedures are same for both. Rear ladder bracket assembly is shown.

Remove nut (1), screw (2), and bracket (3) from frame (4). Discard nut.

b. Installation.

Install bracket (3) on frame (4) with screw (2) and nut (1). Tighten nut.

c. Follow-on Maintenance. Remove wheel chocks (TM 9-2320-279-10).

END OF TASK

Organizational Maintenance Instructions (Cont)

4-52. DATA PLATE REPLACEMENT.

This task covers:

- | | |
|----------------------------------|----------------------------------|
| a. Type 1 Data Plate Replacement | c. Type 3 Data Plate Replacement |
| b. Type 2 Data Plate Replacement | d. Follow-on Maintenance |

INITIAL SETUP*Models*

M1120

Test Equipment

None

Special Tools

Tool Kit, General Mechanic's: Automotive, Item 33, Appendix B

Drill, Electric, Portable, Item 6, Appendix B

Drill Set, Twist, Item 5, Appendix B

Gloves, Chemical Oil Protective, Item 11, Appendix B

Goggles, Industrial, Item 12, Appendix B

Tool Kit, Blind Rivet, Item 30, Appendix B

Supplies

Cloth, Cleaning, Item 5, Appendix F

Drycleaning Solvent, Item 18, Appendix F

Personnel Required

MOS 63S, Heavy wheel vehicle mechanic

References

None

Equipment Condition

<i>TM or Para</i>	<i>Condition Description</i>
TM 9-2320-279-10	Engine OFF
TM 9-2320-279-10	Wheels chocked

Special Environmental Conditions

None

General Safety Instructions

None

Organizational Maintenance Instructions (Cont)

4-52. DATA PLATE REPLACEMENT (CONT).

a. Type 1 Data Plate Replacement.

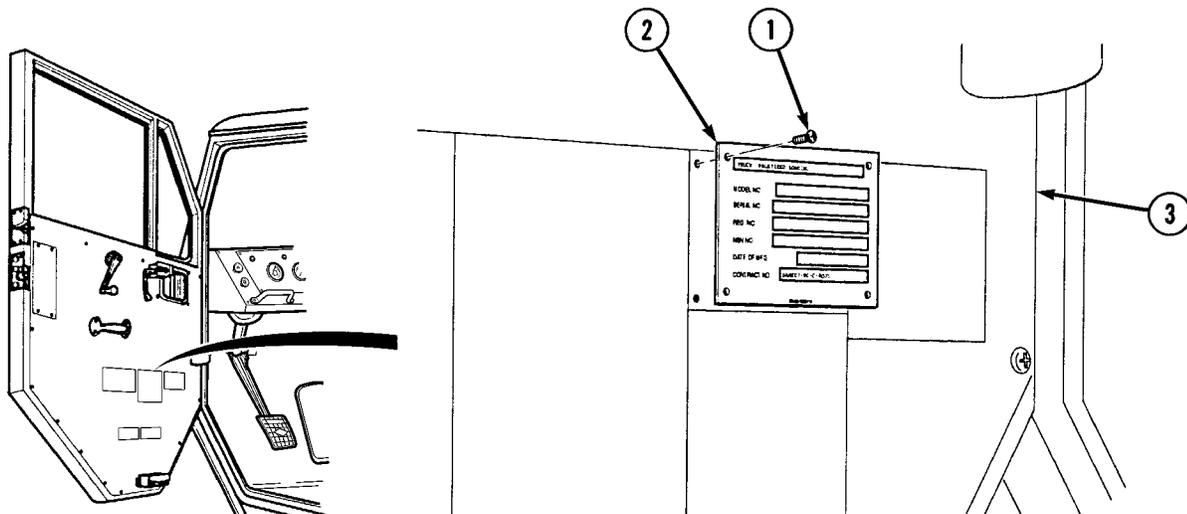

NOTE

- Subparagraphs a. through c. show all typical data plates used on the truck.
- Refer to Appendix G and TM 9-2320-279-10 for location of all data plates.

- (1) *Removal.* Remove four screws (1) and data plate (2) from frame (3).
 (2) *Installation.* Install data plate (2) on frame (3) with four screws (1).

b. Type 2 Data Plate Replacement.

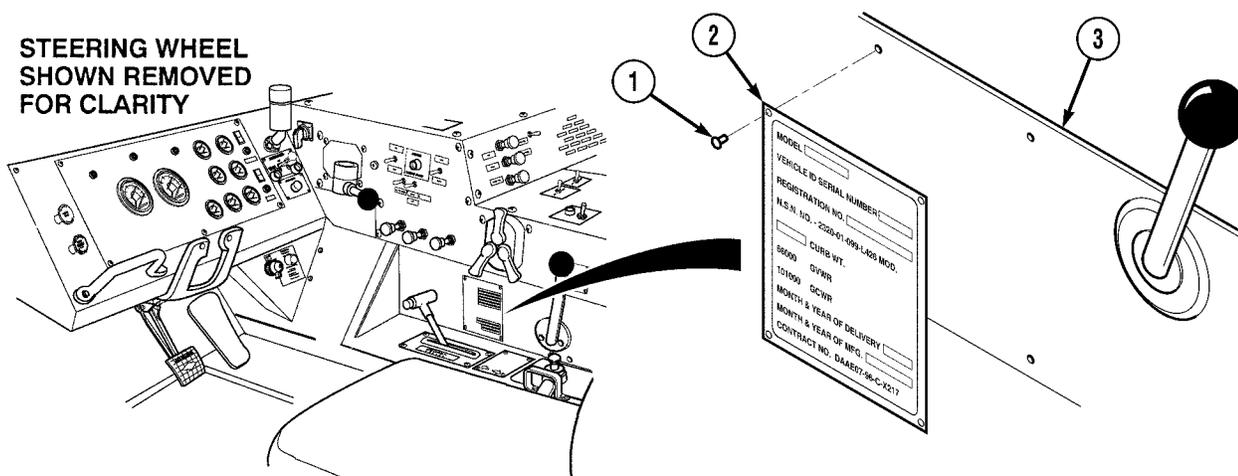

- (1) *Removal.* Using a 1/8 in. drill bit, remove four rivets (1) and data plate (2) from frame (3). Discard rivets.
 (2) *Installation.* Install data plate (2) on frame (3) with four rivets (1).

Organizational Maintenance Instructions (Cont)

c. Type 3 Data Plate Replacement.

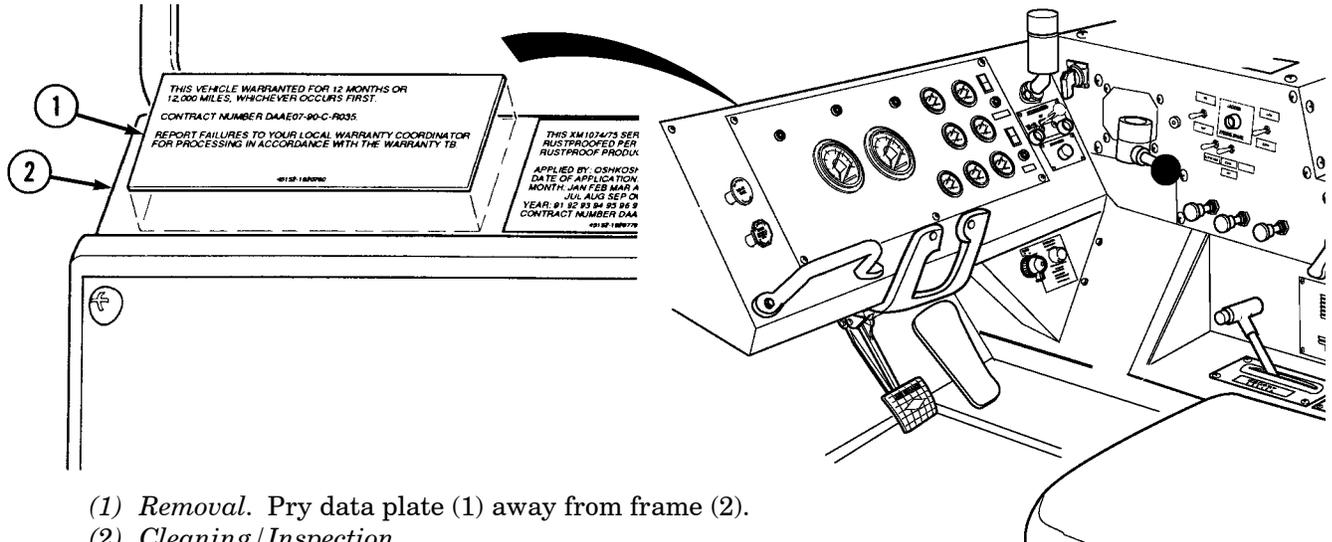

- (1) Removal. Pry data plate (1) away from frame (2).
- (2) Cleaning / Inspection.

WARNING

- Drycleaning solvent (P-D-680) is TOXIC and flammable. Wear protective goggles, face shield, and gloves; use only in a well-ventilated area; avoid contact with skin, eyes, and clothes; and do not breathe vapors. Keep away from heat or flame. Never smoke when using solvent. The flashpoint for Type III Drycleaning Solvent is 200° F (93° C). Failure to do so may result in injury or death to personnel.
- If personnel become dizzy while using cleaning solvent, immediately get fresh air and medical help. If solvent contacts skin or clothes, flush with cold water. If solvent contacts eyes, immediately flush eyes with water and get immediate medical attention.
 - (a) Ensure surface is free of any dirt or debris.
 - (b) Clean with lint-free cloth and drycleaning solvent.

- (3) Installation. Peel paper off data plate (1) and place on frame (2).

d. Follow-on Maintenance. Remove wheel chocks (TM 9-2320-279-10).

END OF TASK

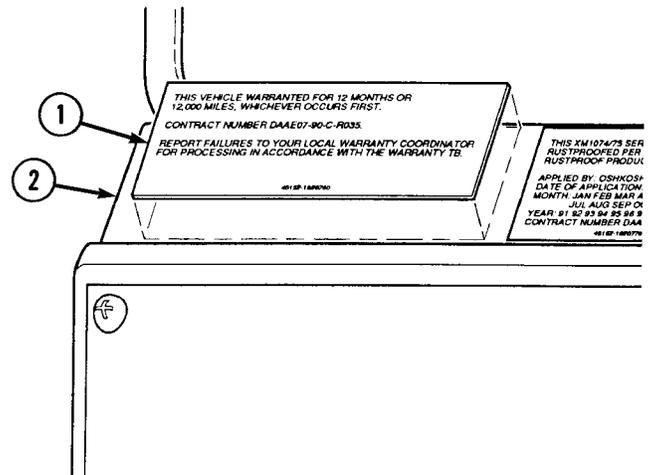

Organizational Maintenance Instructions (Cont)

4-53. DECK ASSEMBLY REPLACEMENT.	
This task covers:	
a. Removal	b. Installation
c. Follow-on Maintenance	
INITIAL SETUP	
<i>Models</i> M1120	<i>References</i> None
<i>Test Equipment</i> None	<i>Equipment Condition</i> TM or Para Condition Description TM 9-2302-279-10 Engine OFF TM 9-2320-279-10 Wheels chocked
<i>Special Tools</i> Tool Kit, General Mechanic's: Automotive, Item 33, Appendix B	<i>Special Environmental Conditions</i> None
<i>Supplies</i> Locknuts (8), Item 1, Appendix K	<i>General Safety Instructions</i> None
<i>Personnel Required</i> MOS 63S, Heavy wheel vehicle mechanic	

a. Removal.

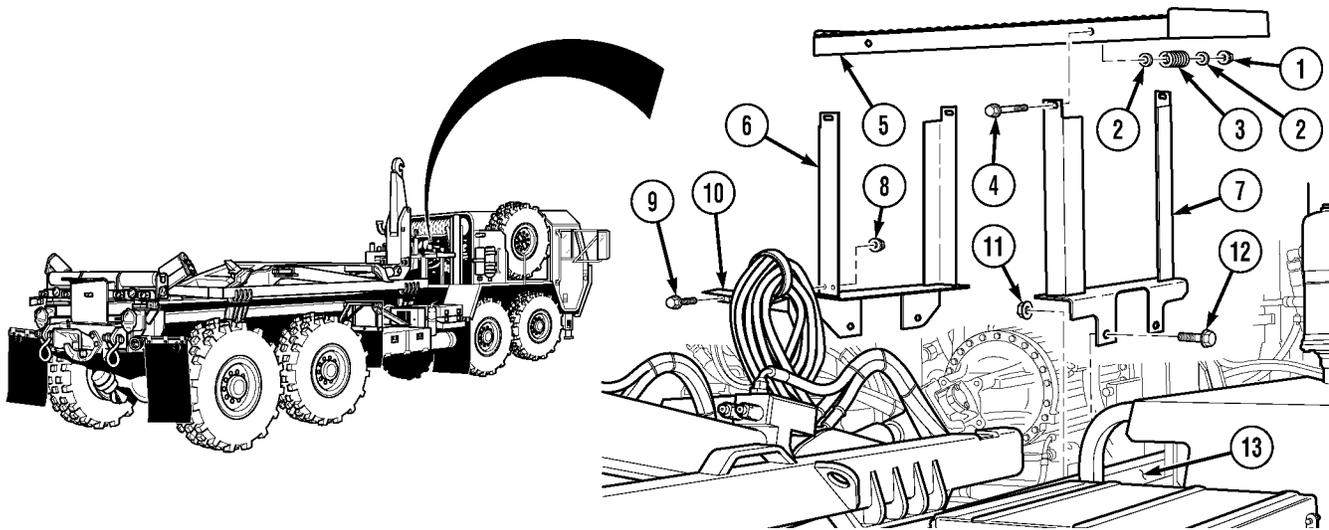

WARNING

After removing deck, caution must be used not to get impaled on brackets.

- (1) Remove four locknuts (1), eight washers (2), four springs (3), four screws (4), and deck (5) from brackets (6 and 7). Discard locknuts.
- (2) Remove two locknuts (8), screws (9), and bracket (10) from bracket (6). Discard locknuts.
- (3) Remove four locknuts (11) and screws (12) from brackets (6 and 7). Discard locknuts.

NOTE

Left-hand bracket must be rotated towards the front of the truck to remove.

- (4) Remove brackets (6 and 7) from frame rail (13).

Organizational Maintenance Instructions (Cont)

b. Installation.**NOTE**

Left-hand bracket must be rotated under hydraulic hoses to install.

- (1) Install brackets (1 and 2) on frame rail (3) with screws (4) and locknuts (5).
- (2) Install deck (6) on brackets (1 and 2) with four screws (7), four springs (9), eight washers (8), and four locknuts (10).
- (3) Install bracket (11) on bracket (2) with two screws (12) and locknuts (13).

c. Follow-on Maintenance. Remove wheel chocks (TM 9-2320-279-10).

END OF TASK

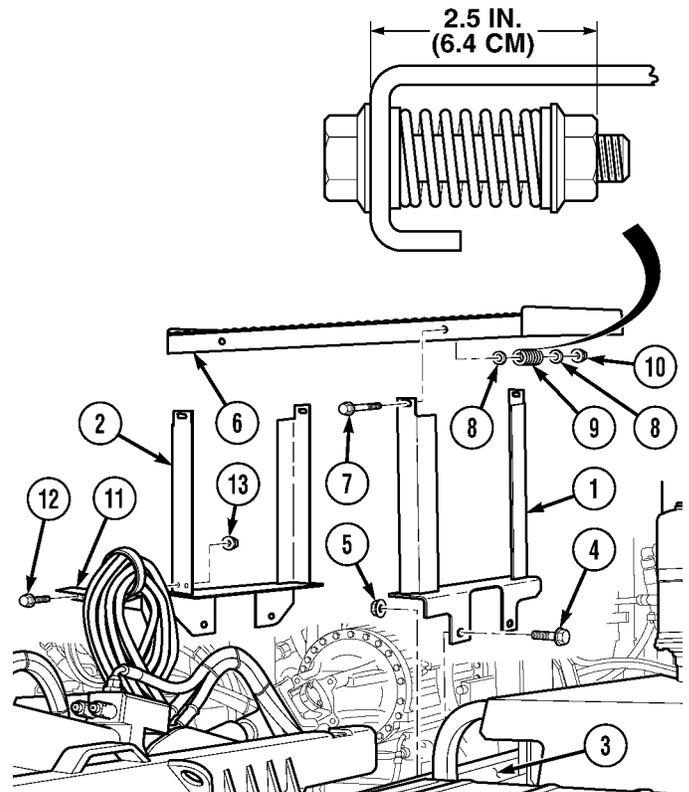

Organizational Maintenance Instructions (Cont)

4-53.1 CONTAINER HANDLING UNIT (CHU) CONTAINER GUIDE REPAIR.

This task covers:

- | | | |
|----------------|------------------------|--------------------------|
| a. Removal | c. Cleaning/Inspection | e. Installation |
| b. Disassembly | d. Assembly | f. Follow-on Maintenance |

INITIAL SETUP

Models

M1120

Personnel Required

MOS 63S, Heavy wheel vehicle mechanic

Test Equipment

None

References

None

Special Tools

Tool Kit, General Mechanic's: Automotive, Item 33, Appendix B
 Compressor Unit, Air, Item 2.2, Appendix B
 Gloves, Chemical Oil Protective, Item 11, Appendix B
 Goggles, Industrial, Item 12, Appendix B
 Gun, Air Blow, Item 12.1, Appendix B

Equipment Condition

<i>TM or Para</i>	<i>Condition Description</i>
TM 9-2320-279-10	Engine OFF
TM 9-2320-279-10	Wheels chocked

Special Environmental Conditions

None

Supplies

None

General Safety Instructions

None

Organizational Maintenance Instructions (Cont)

a. Removal.

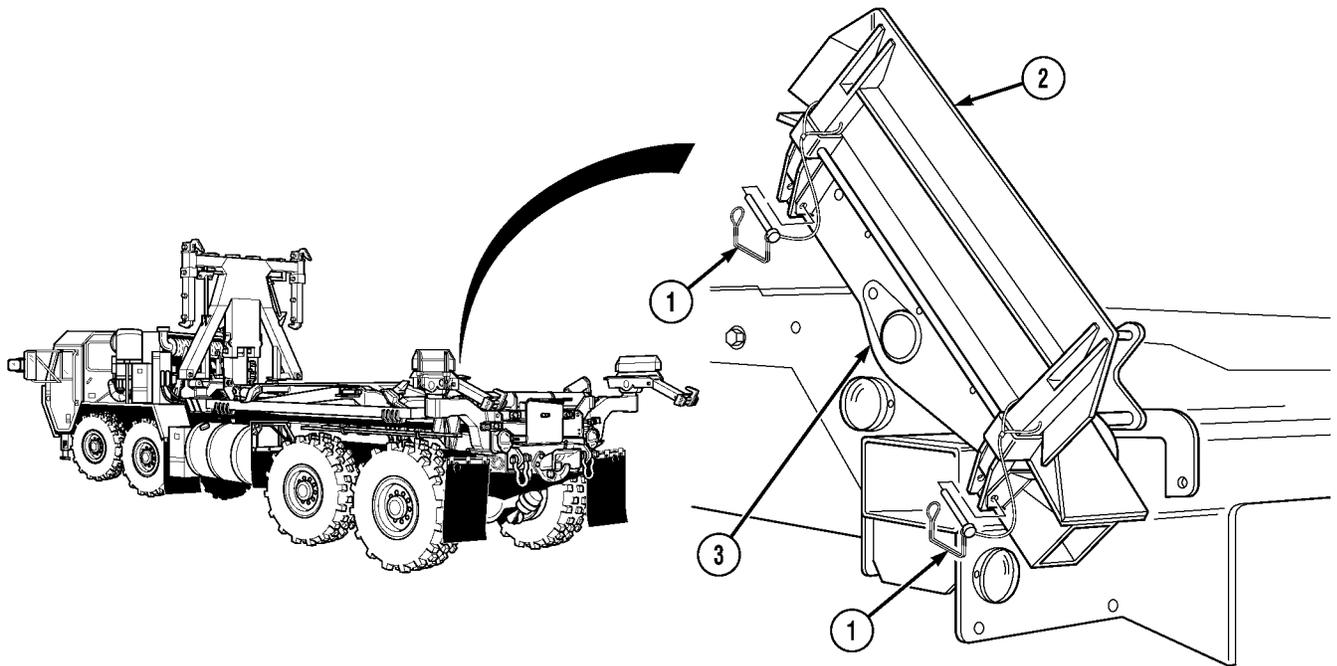

NOTE

- If CHU is in container mode, perform step (1). If CHU is in flatrack mode, perform step (2).
- There are two container guides. Left and right side container guides are removed the same way. Left side is shown.

(1) Remove two lock pins (1) and container guide (2) from slider (3).

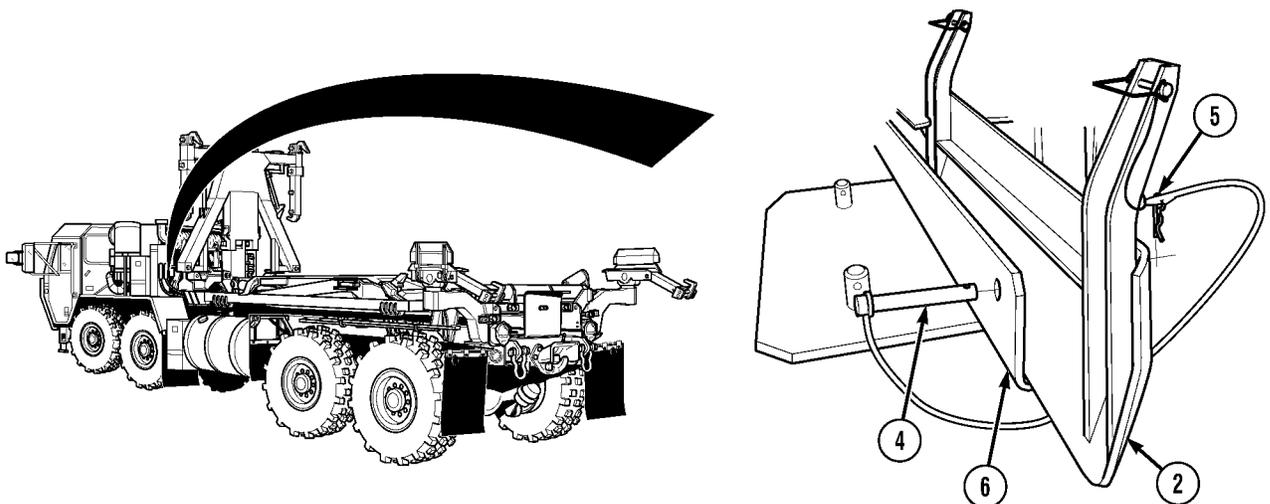

(2) Remove lock pin (4), pin (5), and container guide (2) from stow bracket (6).

Organizational Maintenance Instructions (Cont)

4-53.1 CONTAINER HANDLING UNIT (CHU) CONTAINER GUIDE REPAIR (CONT).**b. Disassembly.****NOTE**

- Perform step (1) if wire rope or lock pin is damaged.
 - There are two lock pins on container guide. Left side is shown.
- (1) Remove two swaging sleeves (1), wire rope (2), and lock pin (3) from container guide (4). Discard wire rope and swaging sleeves.

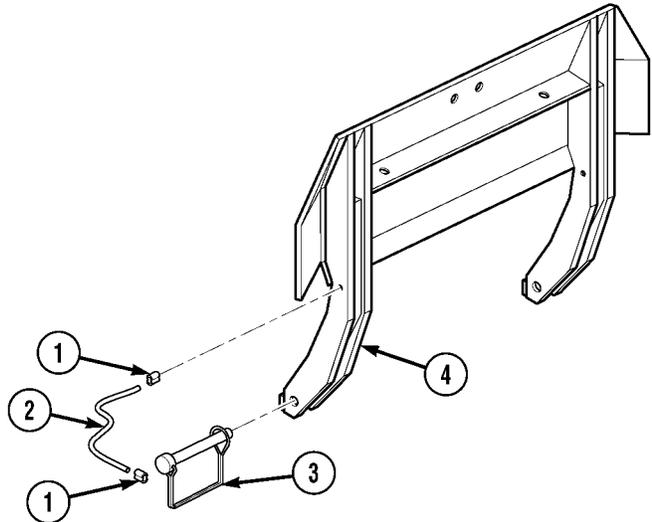
**c. Cleaning/Inspection.****WARNING**

- Drycleaning Solvent (P-D-680) is TOXIC and flammable. Wear protective goggles, face shield, and gloves; use only in a well-ventilated area; avoid contact with skin, eyes, and clothes; and do not breathe vapors. Keep away from heat or flame. Never smoke when using solvent. The flashpoint for Type III Drycleaning Solvent is 200°F (93°C). Failure to do so may result in injury or death to personnel.
 - If personnel become dizzy while using cleaning solvent, immediately get fresh air and medical help. If solvent contacts skin or clothes, flush with cold water. If solvent contacts eyes, immediately flush eyes with water and get immediate medical attention.
- (1) Clean all metal parts with drycleaning solvent.

WARNING

Compressed air used for cleaning purposes shall not exceed 30 psi (207 kPa). Use only with effective chip guarding and personal protective equipment (goggles/shield, gloves, etc.), or injury to personnel may result.

- (2) Dry parts with compressed air.
- (3) Inspect parts for breaks, cracks, burrs, and sharp edges. Look for unusual signs of wear on container guide.
- (4) Replace all damaged parts.

Organizational Maintenance Instructions (Cont)

d. Assembly.

NOTE

- Perform step below if wire rope or lock pin was removed.
- There are two lock pins on container guide. Left side is shown.

Install wire rope (1), swaging sleeves (2), and lock pin (3) on container guide (4).

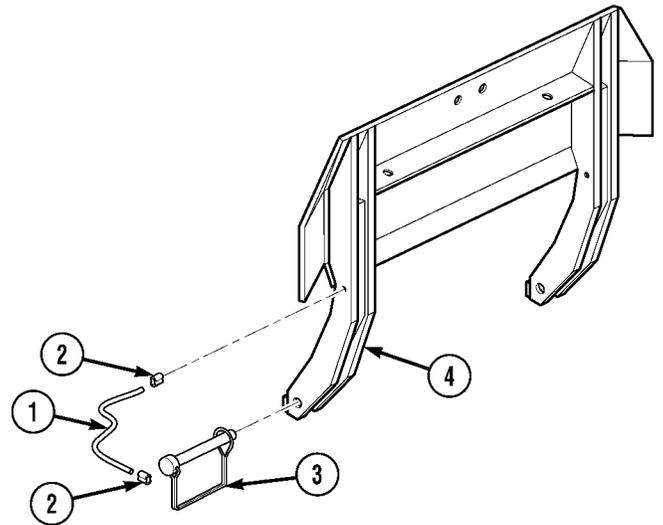

e. Installation.

NOTE

- If CHU is in flatrack mode, perform step (1). If CHU is in container mode, perform step (2).
- Installation of left-side and right-side container guides is the same. Left side is shown.

(1) Install container guide (1) with pin (2) and lock pin (3) on stow bracket (4).

(2) Install container guide (1) on slider (5) with two lock pins (6).

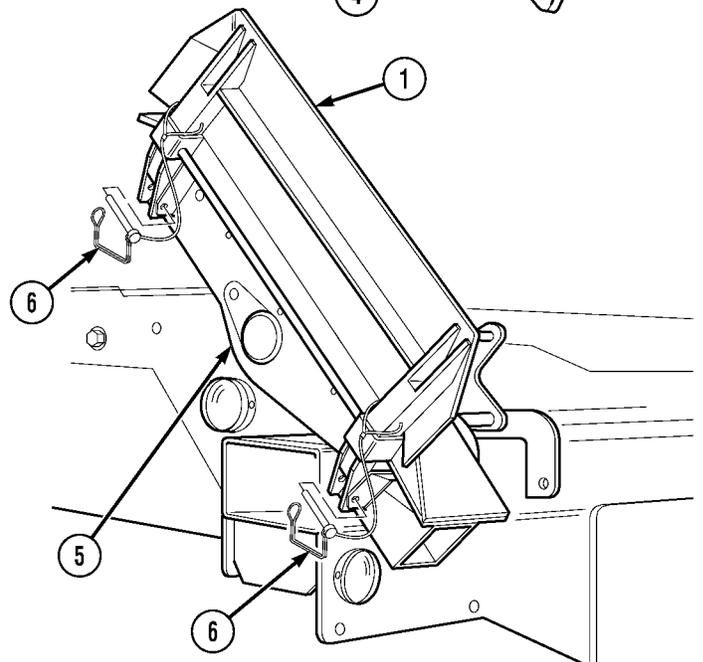
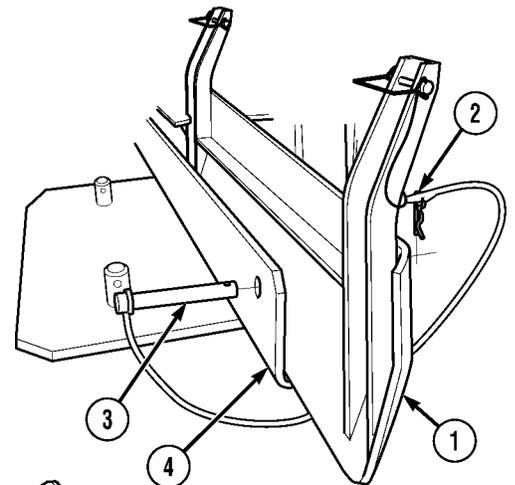

f. Follow-on Maintenance. Remove wheel chocks (TM 9-2320-279-10).

END OF TASK

Organizational Maintenance Instructions (Cont)

4-53.2 CONTAINER HANDLING UNIT (CHU) SLIDER/PIVOT ASSEMBLY REPAIR.

This task covers:

- | | | |
|----------------|------------------------|--------------------------|
| a. Removal | c. Cleaning/Inspection | e. Installation |
| b. Disassembly | d. Assembly | f. Follow-on Maintenance |

INITIAL SETUP

Models

M1120

Test Equipment

None

Special Tools

- Tool Kit, General Mechanic's: Automotive, Item 33, Appendix B
- Compressor Unit, Air, Item 2.2, Appendix B
- Gloves, Chemical Oil Protective, Item 11, Appendix B
- Goggles, Industrial, Item 12, Appendix B
- Gun, Air Blow, Item 12.1, Appendix B
- Lifting Device, Minimum Capacity 140 lbs. (64 kg)
- Pliers, Retaining Ring, Item 19, Appendix B

Supplies

- Grease, Item 8, Appendix F
- Sealing Compound, Item 15, Appendix F
- Sealing Compound, Item 16, Appendix F
- Locknut (10), Item 3.1, Appendix K
- Locknut (2), Item 11, Appendix K

Supplies (cont)

- Pin, Cotter (2), Item 31.1, Appendix K
- Pin, Roll, Item 32.1, Appendix K
- Ring, Retaining, Item 41.1, Appendix K
- Screw, Self-Tapping (2), Item 42.1, Appendix K
- Seal (2), Item 43.1, Appendix K

Personnel Required

MOS 63S, Heavy wheel vehicle mechanic (2)

References

None

Equipment Condition

<i>TM or Para</i>	<i>Condition Description</i>
TM 9-2320-279-10	Engine OFF
TM 9-2320-279-10	Wheels chocked
Para 4-45.1	Limit switch removed
Para 2-10.1	Slider in container mode

Special Environmental Conditions

None

General Safety Instructions

None

Organizational Maintenance Instructions (Cont)

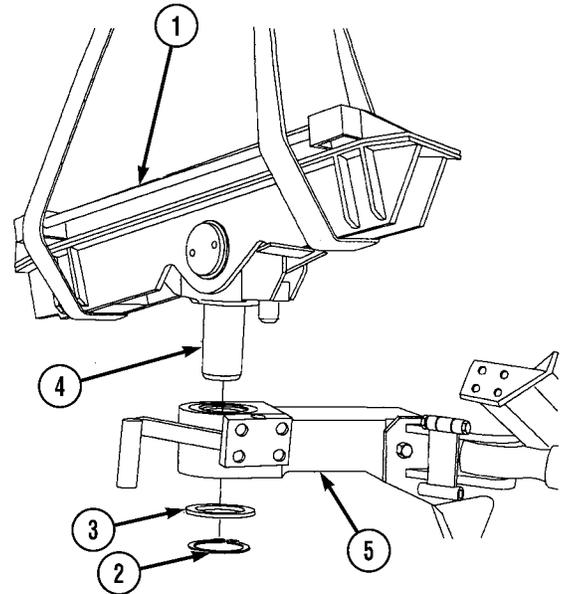
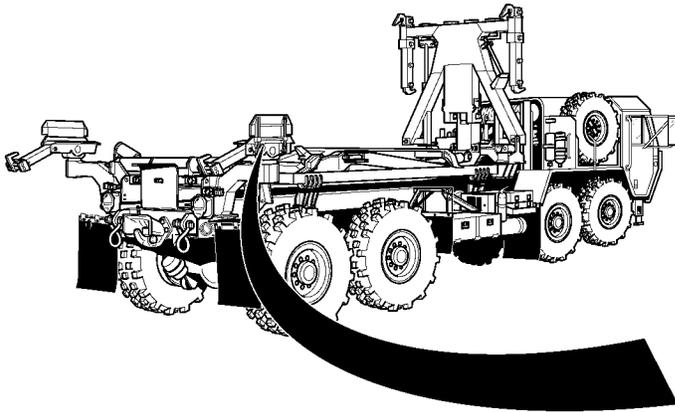
a. Removal.**WARNING**

Slider weighs 142 lbs. (64 kg). Attach suitable lifting device to prevent possible injury to personnel.

NOTE

- Left-side and right-side slider/pivot assemblies are identical unless noted.
- Right-side slider/pivot assembly is shown.

(1) Attach lifting device to slider assembly (1).

WARNING

Use care when removing snap and retaining rings. Snap and retaining rings are under spring tension and can act as projectiles when released and could cause severe eye injury.

- (2) Remove retaining ring (2) and spacer (3) from pivot pin (4) and slider assembly (1). Discard retaining ring.
- (3) Soldier A and Soldier B remove slider assembly (1) from arm assembly (5).
- (4) Position slider assembly (1) on clean work surface and remove lifting device.

Organizational Maintenance Instructions (Cont)

4-53.2 CONTAINER HANDLING UNIT (CHU) SLIDER/PIVOT ASSEMBLY REPAIR (CONT).

b. Disassembly.

WARNING

Use care when removing snap and retaining rings. Snap and retaining rings are under spring tension and can act as projectiles when released and could cause severe eye injury.

- (1) Remove retaining ring (1), pivot pin (2), spacer (3) and slider pivot (4) from slider (5).

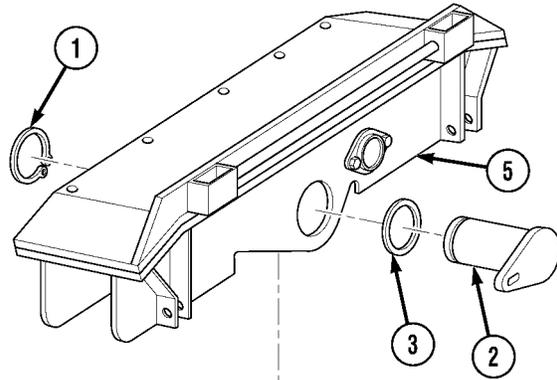

NOTE

Note position of torsion spring prior to removal.

- (2) Remove locknut (6) from screw (7). Discard locknut.

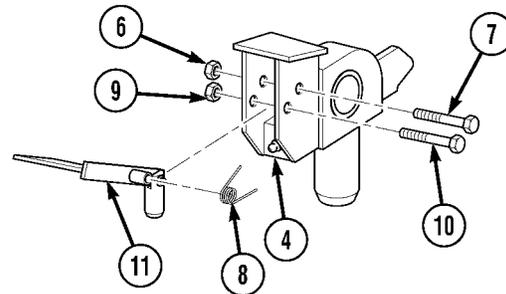

WARNING

Use care when removing springs. Springs are under tension and can act as projectiles when released and could cause injury to personnel.

- (3) Push in on end of torsion spring (8) and remove screw (7) from slider pivot (4).
- (4) Remove locknut (9), screw (10), torsion spring (8), and pivot lock arm (11) from slider pivot (4). Release torsion spring and discard locknut.
- (5) Remove two cotter pins (12), washers (13), pivot lock slot pin (14), and pivot lock pin (15) from pivot lock arm (11). Discard cotter pins.

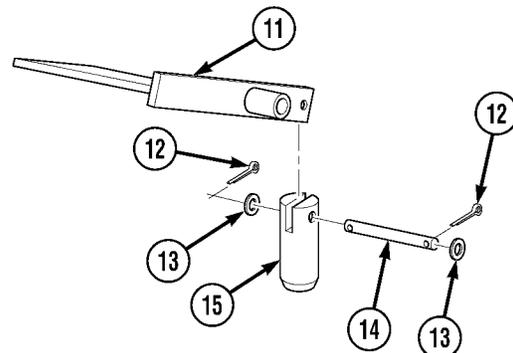

Organizational Maintenance Instructions (Cont)

- (6) Remove two grease fittings (16) from slider pivot (4).
- (7) Remove two seals (17) from slider pivot (4). Discard seals.

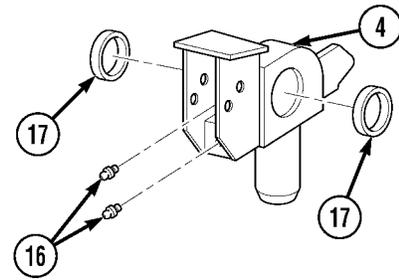

- (8) Remove ten socket head screws (18), locknuts (19), and wear plate (20) from slider (5). Discard locknuts.
- (9) Remove two self-tapping screws (21), reflector housing (22), and reflector (23) from slider (5). Discard self-tapping screws.

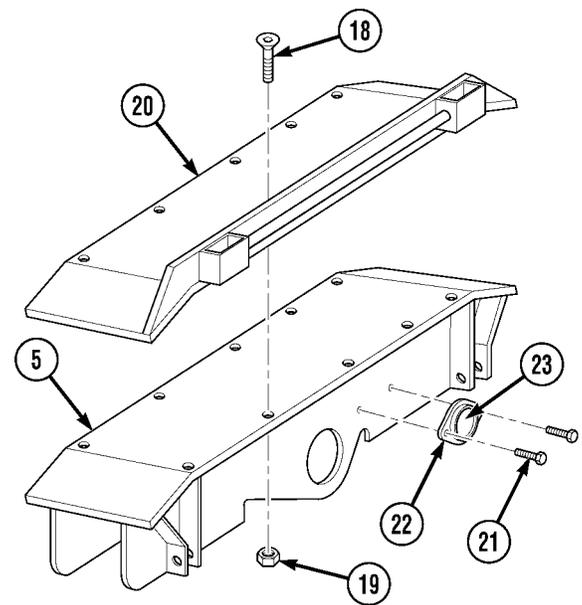

- (10) Remove grease fitting (24) from slider (5).
- (11) Remove roll pin (25), handle (26), spring (27), and pin (28) from slider (5). Discard roll pin.

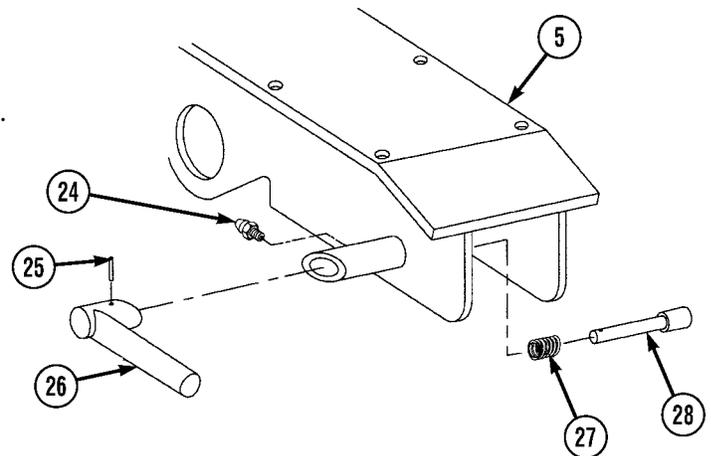

Organizational Maintenance Instructions (Cont)

4-53.2 CONTAINER HANDLING UNIT (CHU) SLIDER/PIVOT ASSEMBLY REPAIR (CONT).

c. Cleaning/Inspection.

WARNING

- Drycleaning Solvent (P-D-680) is TOXIC and flammable. Wear protective goggles, face shield, and gloves; use only in a well-ventilated area; avoid contact with skin, eyes, and clothes; and do not breathe vapors. Keep away from heat or flame. Never smoke when using solvent. The flashpoint for Type III Drycleaning Solvent is 200°F (93°C). Failure to do so may result in injury or death to personnel.
- If personnel become dizzy while using cleaning solvent, immediately get fresh air and medical help. If solvent contacts skin or clothes, flush with cold water. If solvent contacts eyes, immediately flush eyes with water and get immediate medical attention.

- (1) Clean all metal parts with drycleaning solvent.

WARNING

Compressed air used for cleaning purposes shall not exceed 30 psi (207 kPa). Use only with effective chip guarding and personal protective equipment (goggles/shield, gloves, etc.), or injury to personnel may result.

- (2) Dry parts with compressed air.
- (3) Inspect parts for breaks, cracks, burrs, and sharp edges. Look for unusual signs of wear on slider.
- (4) Replace all damaged parts.

d. Assembly.

- (1) Install spring (1), pin (2), handle (3), and roll pin (4) on slider (5).
- (2) Install grease fitting (6) on slider (5).

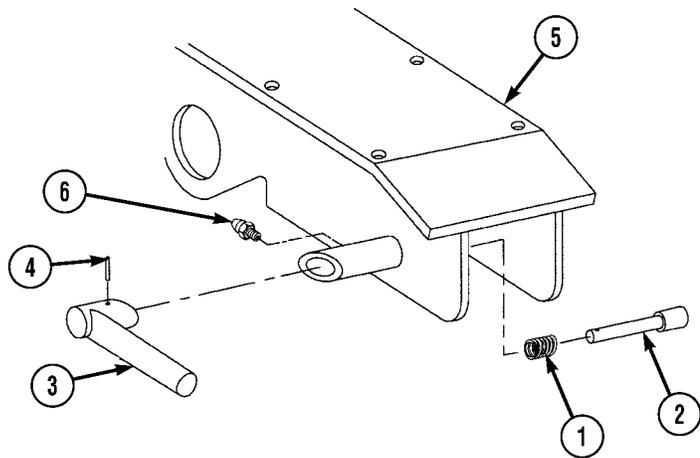

Organizational Maintenance Instructions (Cont)

- (3) Install reflector (7), reflector housing (8), and two self-tapping screws (9) on slider (5).
- (4) Position wear plate (10) on slider (5) and install ten socket head screws (11) and locknuts (12).

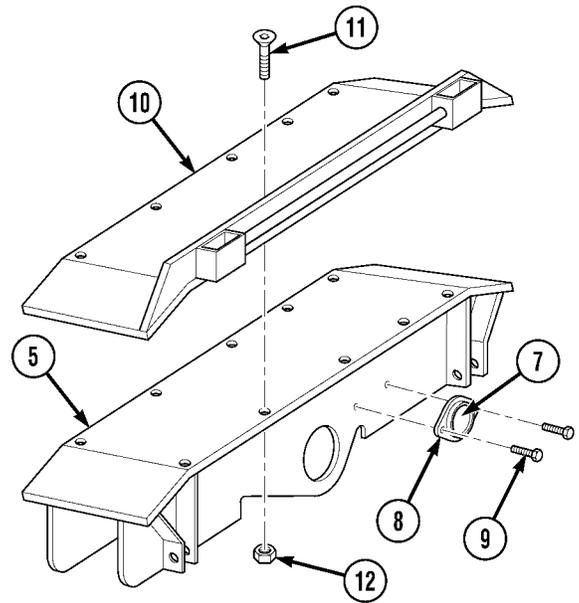

NOTE

Seals must be installed with open groove to the outside.

- (5) Install two seals (13) in slider pivot (14).
- (6) Install two grease fittings (15) in slider pivot (14).

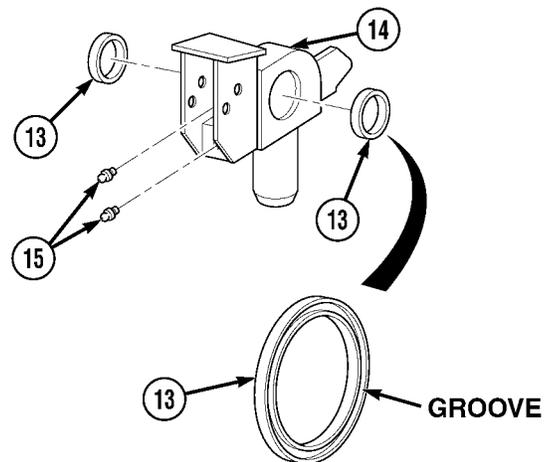

Organizational Maintenance Instructions (Cont)

4-53.2 CONTAINER HANDLING UNIT (CHU) SLIDER/PIVOT ASSEMBLY REPAIR (CONT).

- (7) Install pivot lock pin (16), pivot lock slot pin (17), two washers (18), and cotter pins (19) on pivot lock arm (20).

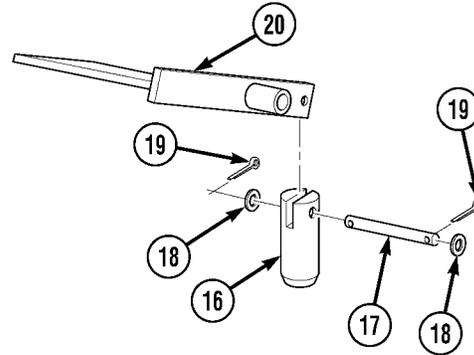

NOTE

- Make sure torsion spring is installed as noted prior to removal.
- Make sure there is clearance between pivot lock arm and slider pivot when tightening hardware.

- (8) Install pivot lock arm (20), torsion spring (21), screw (22), and locknut (23) in slider pivot (14).
- (9) Push in on end of torsion spring (21) and install screw (24) and locknut (25) in slider pivot (14).

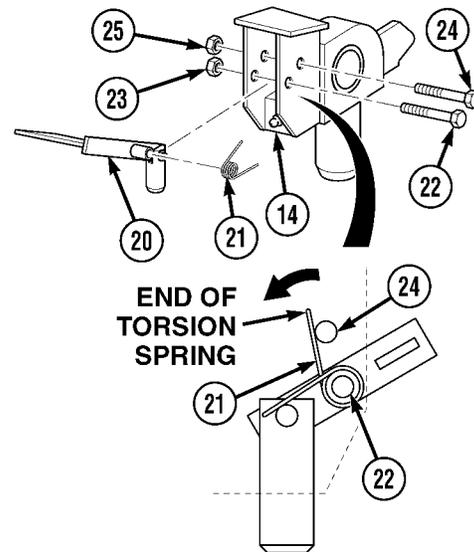

Organizational Maintenance Instructions (Cont)

NOTE

Make sure end of pivot pin aligns with stud on slider during installation.

- (10) Soldier A and Soldier B position slider pivot (14) in slider (5) and install spacer (26), pivot pin (27), and retaining ring (28).

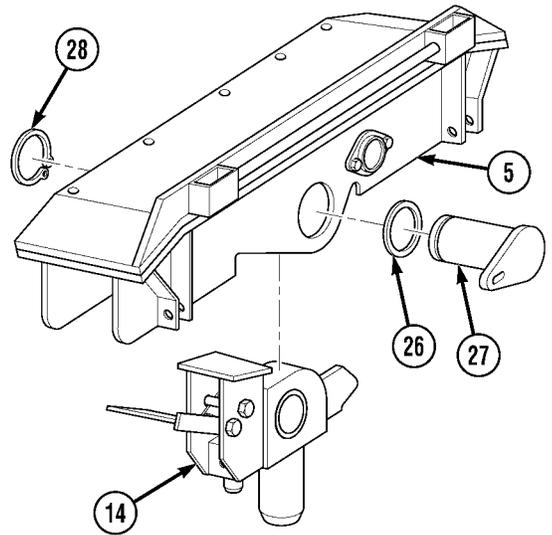

e. Installation.

WARNING

Slider weighs 142 lbs. (64 kg). Attach suitable lifting device to prevent possible injury to personnel.

- (1) Attach lifting device to slider assembly (1).
- (2) Apply light coat of grease to outer surface of slider pivot pin (2), spacer (3), and retaining ring (4).

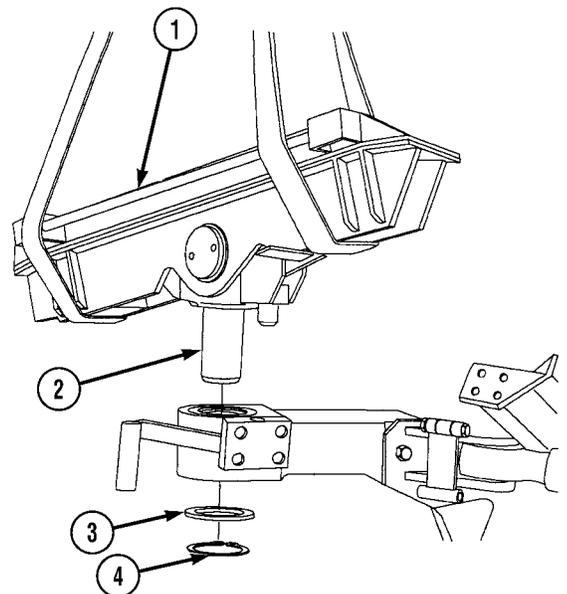

Organizational Maintenance Instructions (Cont)

4-53.2 CONTAINER HANDLING UNIT (CHU) SLIDER/PIVOT ASSEMBLY REPAIR (CONT).

NOTE

Make sure retaining ring is fully seated in step (3).

- (3) Soldier A and Soldier B position slider pivot pin (2) in arm assembly (5) and install spacer (3) and retaining ring (4).
- (4) Remove lifting device from slider assembly (1).
- (5) Check that pivot lock pin (6) properly locks into handle (7).

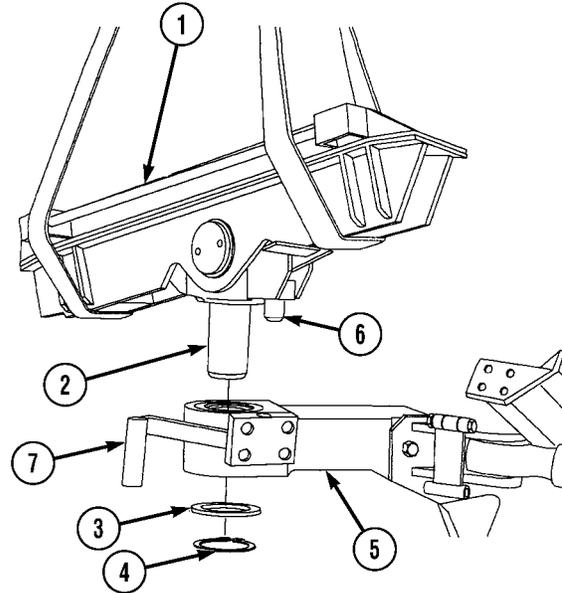

NOTE

If pivot lock pin does not properly lock into handle, perform steps (6) through (9).

- (6) Remove four screws (8) and handle (7) from arm assembly (5).

WARNING

Adhesives, solvents, and sealing compounds can burn easily, can give off harmful vapors, and are harmful to skin and clothing. To avoid injury or death, keep away from open fire and use in well-ventilated area. If adhesive, solvent, or sealing compound gets on skin or clothing, wash immediately with soap and water.

- (7) Apply sealing compound (loctite 242) to threads of four screws (8).

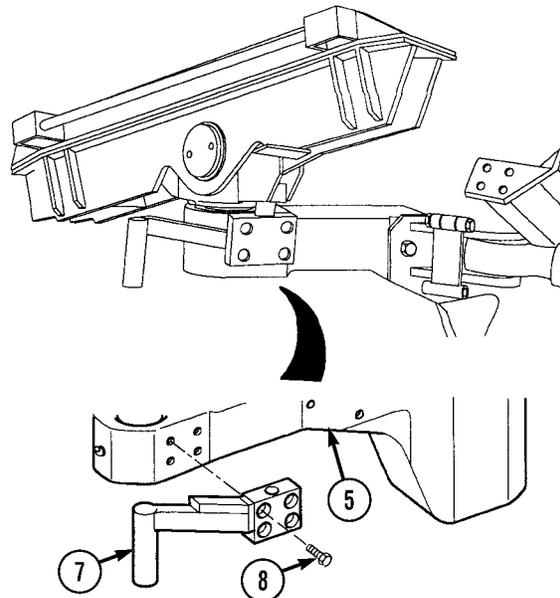

Organizational Maintenance Instructions (Cont)

- (8) Install four screws (8) and handle (7) on right arm assembly (5).
- (9) Repeat step (5).

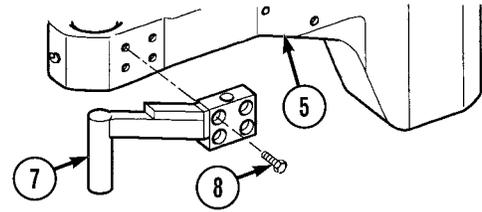
**f. Follow-on Maintenance.**

- (1) Install limit switch (Para 4-45.1).
- (2) Lubricate CHU slider/pivot assembly (Para 3-1).
- (3) Remove wheel chocks (TM 9-2320-279-10).

END OF TASK

Organizational Maintenance Instructions (Cont)

4-53.3 CONTAINER HANDLING UNIT (CHU) SLIDER WEAR PLATE REPLACEMENT.

This task covers:

- | | |
|------------------------|--------------------------|
| a. Removal | c. Installation |
| b. Cleaning/Inspection | d. Follow-on Maintenance |

INITIAL SETUP

Models

M1120

Personnel Required

MOS 63S, Heavy wheel vehicle mechanic (2)

Test Equipment

None

References

None

Special Tools

Tool Kit, General Mechanic's: Automotive, Item 33, Appendix B
 Compressor Unit, Air, Item 2.2, Appendix B
 Gloves, Chemical Oil Protective, Item 11, Appendix B
 Goggles, Industrial, Item 12, Appendix B
 Gun, Air Blow, Item 12.1, Appendix B

Equipment Condition

<i>TM or Para</i>	<i>Condition Description</i>
TM 9-2320-279-10	Engine OFF
TM 9-2320-279-10	Wheels chocked
Para 2-10.1	Slider arm in container mode

Special Environmental Conditions

None

Supplies

Solvent, Drycleaning, Item 18, Appendix F
 Locknut (10), Item 1.2, Appendix K

General Safety Instructions

None

Organizational Maintenance Instructions (Cont)

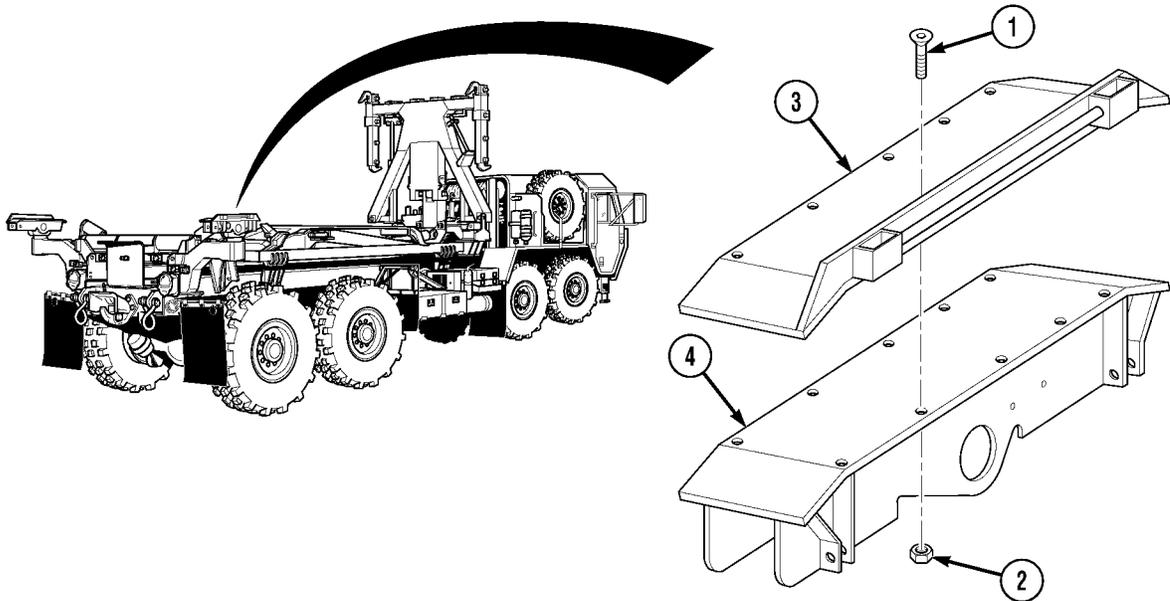
a. Removal.

Remove ten socket head screws (1), locknuts (2), and wear plate (3) from slider (4). Discard locknuts.

b. Cleaning/Inspection.**WARNING**

- Drycleaning Solvent (P-D-680) is TOXIC and flammable. Wear protective goggles, face shield, and gloves; use only in a well-ventilated area; avoid contact with skin, eyes, and clothes; and do not breathe vapors. Keep away from heat or flame. Never smoke when using solvent. The flashpoint for Type III Drycleaning Solvent is 200° F (93°C). Failure to do so may result in injury or death to personnel.
- If personnel become dizzy while using cleaning solvent, immediately get fresh air and medical help. If solvent contacts skin or clothes, flush with cold water. If solvent contacts eyes, immediately flush eyes with water and get immediate medical attention.

- (1) Clean all metal parts with drycleaning solvent.

WARNING

Compressed air used for cleaning purposes shall not exceed 30 psi (207 kPa). Use only with effective chip guarding and personal protective equipment (goggles/shield, gloves, etc.), or injury to personnel may result.

- (2) Dry parts with compressed air.
- (3) Inspect parts for breaks, cracks, burrs, and sharp edges. Look for unusual signs of wear on wear plate.
- (4) Replace all damaged parts.

Organizational Maintenance Instructions (Cont)

4-53.3 CONTAINER HANDLING UNIT (CHU) SLIDER WEAR PLATE REPLACEMENT (CONT).

c. Installation.

- (1) Position wear plate (1) on slider (2) and install ten socket head screws (3) and locknuts (4).

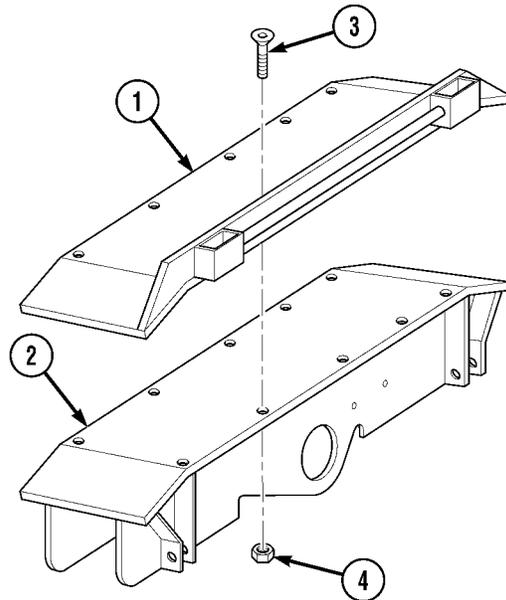

d. Follow-on Maintenance.

- (1) Lubricate wear plates (Para 3-2).
- (2) Remove wheel chocks (TM 9-2320-279-10).

END OF TASK

Organizational Maintenance Instructions (Cont)

4-53.4 CONTAINER HANDLING UNIT (CHU) SHORT STRUT AND PIN BRACKET ASSEMBLY REPAIR.

This task covers:

- | | | |
|------------------------|-----------------|--------------------------|
| a. Removal | d. Assembly | f. Adjustment |
| b. Disassembly | e. Installation | g. Follow-on Maintenance |
| c. Cleaning/Inspection | | |

INITIAL SETUP

Models

M1120

Personnel Required

MOS 63S, Heavy wheel vehicle mechanic (2)

Test Equipment

None

References

None

Special Tools

- Tool Kit, General Mechanic's: Automotive, Item 33, Appendix B
- Compressor Unit, Air, Item 2.2, Appendix B
- Gloves, Chemical Oil Protective, Item 11, Appendix B
- Goggles, Industrial, Item 12, Appendix B
- Gun, Air Blow, Item 12.1, Appendix B
- Pliers, Retaining Ring, Item 19, Appendix B

Equipment Condition

<i>TM or Para</i>	<i>Condition Description</i>
TM 9-2320-279-10	Engine OFF
TM 9-2320-279-10	Wheels chocked
Para 2-10.1	Slider arm in container mode

Special Environmental Conditions

None

Supplies

- Antiseize Compound, Item 6, Appendix F
- Sealing Compound, Item 16, Appendix F

General Safety Instructions

None

Organizational Maintenance Instructions (Cont)

4-53.4 CONTAINER HANDLING UNIT (CHU) SHORT STRUT AND PIN BRACKET ASSEMBLY REPAIR (CONT).

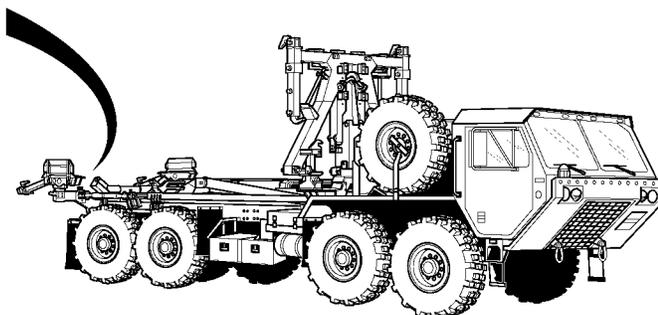
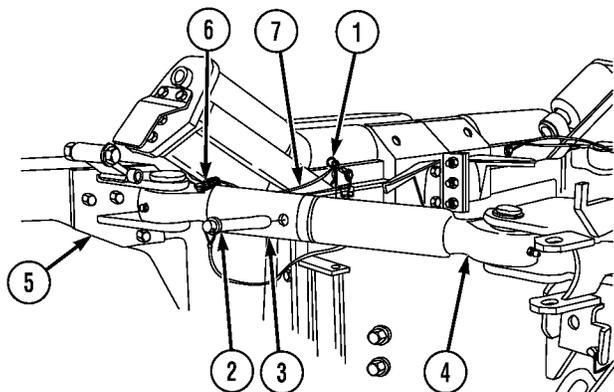

a. Removal.

NOTE

- There are two pin bracket assemblies. Both are removed the same way. Right side is shown.
- Do not support slider arm with flip lock.

- (1) Soldier A and Soldier B remove quick release pin (1) and pin (2) from short strut (3) and long strut (4).
- (2) Soldier A and Soldier B rotate slider arm (5) toward front of truck.

WARNING

Use care when removing springs. Springs are under tension and can act as projectiles when released and could cause injury to personnel.

- (3) Unhook spring (6) from wire (7).

WARNING

Use care when removing snap and retaining rings. Snap and retaining rings are under spring tension and can act as projectiles when released and could cause severe eye injury.

- (4) Remove retaining ring (8) and ring support (9) from short strut (3).
- (5) Remove short strut (3) and spacer (10) from pin bracket (11).

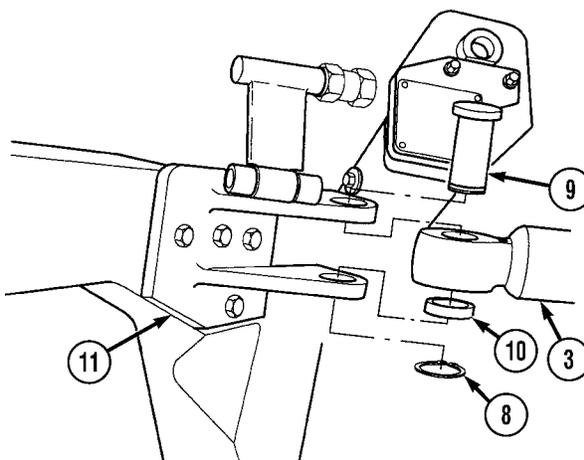

Organizational Maintenance Instructions (Cont)

- (6) Remove four screws (12) and pin bracket (11) from arm assembly (13).

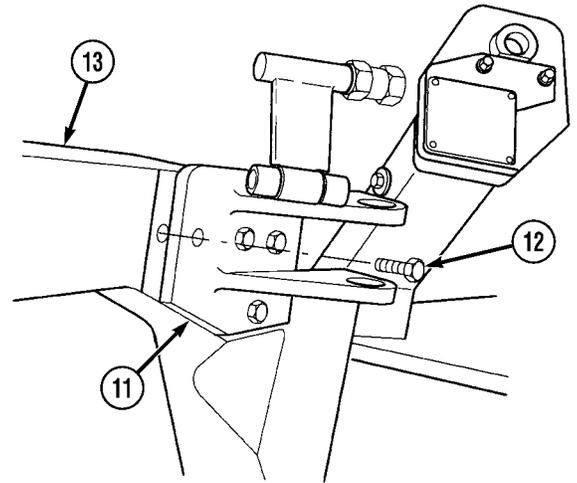

b. Disassembly.

NOTE

Perform steps (1) through (5) only if components are damaged.

- (1) Remove screw (1), washer (2), washer (3), and spring (4) from short strut (5).
- (2) Remove grease fitting (6) from short strut (5).
- (3) Remove retaining ring (7), spacer (8), and bearing (9) from short strut (5).
- (4) Remove screw (10) and jam nut (11) from flip lock (12).
- (5) Remove roll pin (13), pin (14), and flip lock (12) from pin bracket (15).

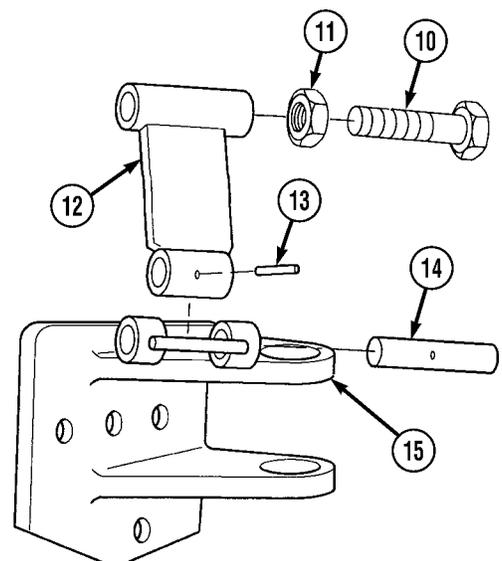
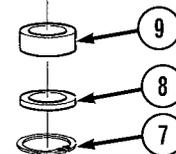
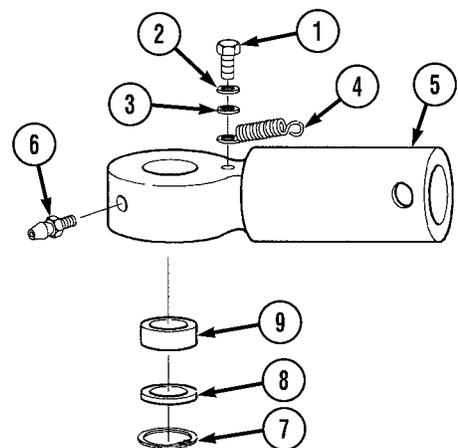

Organizational Maintenance Instructions (Cont)

4-53.4 CONTAINER HANDLING UNIT (CHU) SHORT STRUT AND PIN BRACKET ASSEMBLY REPAIR (CONT).

c. Cleaning/Inspection.

WARNING

- Drycleaning Solvent (P-D-680) is TOXIC and flammable. Wear protective goggles, face shield, and gloves; use only in a well-ventilated area; avoid contact with skin, eyes, and clothes; and do not breathe vapors. Keep away from heat or flame. Never smoke when using solvent. The flashpoint for Type III Drycleaning Solvent is 200° F (93°C). Failure to do so may result in injury or death to personnel.
- If personnel become dizzy while using cleaning solvent, immediately get fresh air and medical help. If solvent contacts skin or clothes, flush with cold water. If solvent contacts eyes, immediately flush eyes with water and get immediate medical attention.

- (1) Clean all metal parts with drycleaning solvent.

WARNING

Compressed air used for cleaning purposes shall not exceed 30 psi (207 kPa). Use only with effective chip guarding and personal protective equipment (goggles/shield, gloves, etc.), or injury to personnel may result.

- (2) Dry parts with compressed air.
- (3) Inspect parts for breaks, cracks, burrs, and sharp edges. Look for unusual signs of wear on short strut.
- (4) Replace all damaged parts.

d. Assembly.

NOTE

Perform steps (1) through (7) only if components were removed.

- (1) Install flip lock (1) to pin bracket (2) with roll pin (3) and pin (4).
- (2) Position jam nut (5) on screw (6) and install screw on flip lock (1). Do not tighten nut.

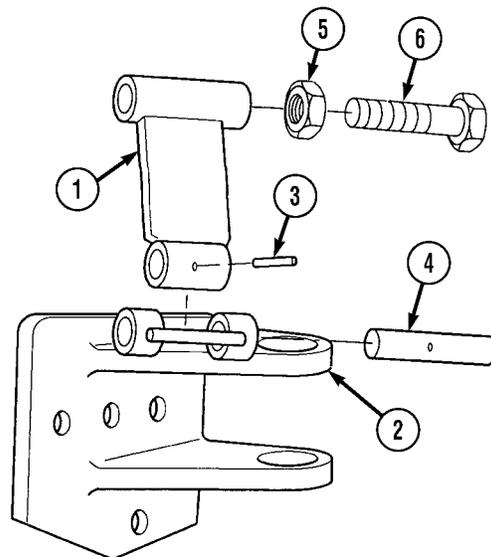

Organizational Maintenance Instructions (Cont)

WARNING

Adhesives, solvents, and sealing compounds can burn easily, can give off harmful vapors, and are harmful to skin and clothing. To avoid injury or death, keep away from open fire and use in well-ventilated area. If adhesive, solvent, or sealing compound gets on skin or clothing, wash immediately with soap and water.

- (3) Apply a light coat of antiseize to outer surface of bearing (7).
- (4) Install bearing (7), spacer (8), and retaining ring (9) in short strut (10).
- (5) Install grease fitting (11) in short strut (10).
- (6) Apply sealing compound to threads of screw (12).
- (7) Install spring (13), washer (14), washer (15), and screw (12) on short strut (10).

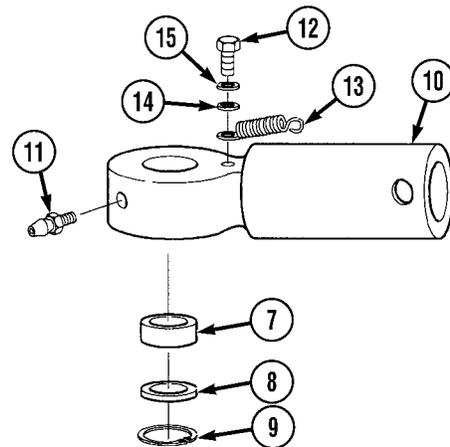
**e. Installation.****WARNING**

Adhesives, solvents, and sealing compounds can burn easily, can give off harmful vapors, and are harmful to skin and clothing. To avoid injury or death, keep away from open fire and use in well-ventilated area. If adhesive, solvent, or sealing compound gets on skin or clothing, wash immediately with soap and water.

NOTE

There are two pin bracket assemblies. Both are installed the same way. Right side is shown.

- (1) Apply sealing compound to threads of four screws (1).
- (2) Install four screws (1) and pin bracket (2) on arm assembly (3).

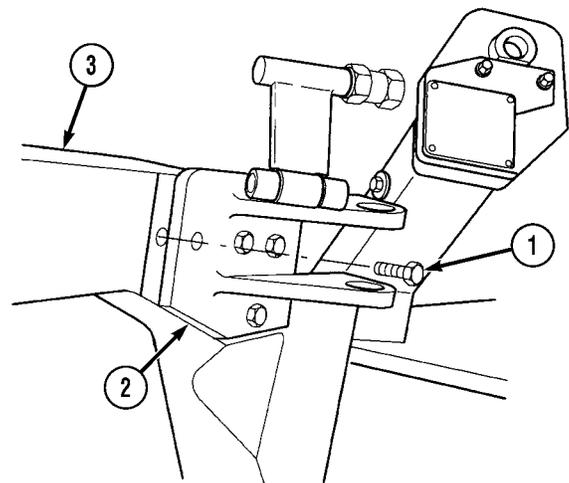

Organizational Maintenance Instructions (Cont)

4-53.4 CONTAINER HANDLING UNIT (CHU) SHORT STRUT AND PIN BRACKET ASSEMBLY REPAIR (CONT).

WARNING

Use care when installing snap and retaining rings. Snap and retaining rings are under spring tension and can act as projectiles when released and could cause severe eye injury.

NOTE

Beveled edge of spacer faces bearing in short strut.

- (3) Install ring support (4), spacer (5), short strut (6), and retaining ring (7) on pin bracket (2).
- (4) Hook spring (8) on wire (9).
- (5) Soldier A and Soldier B support slider arm (10) and position short strut (6) in long strut (11) and install pin (12) and quick release pin (13).

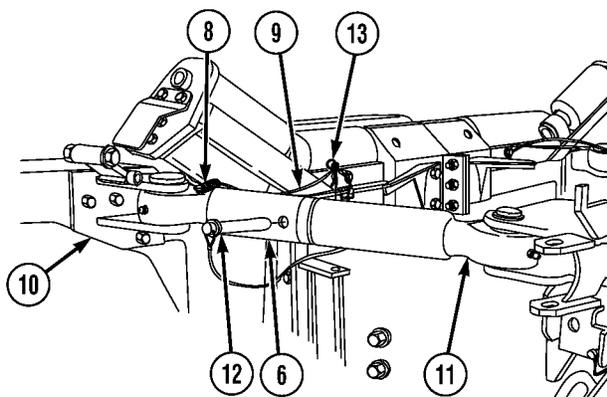
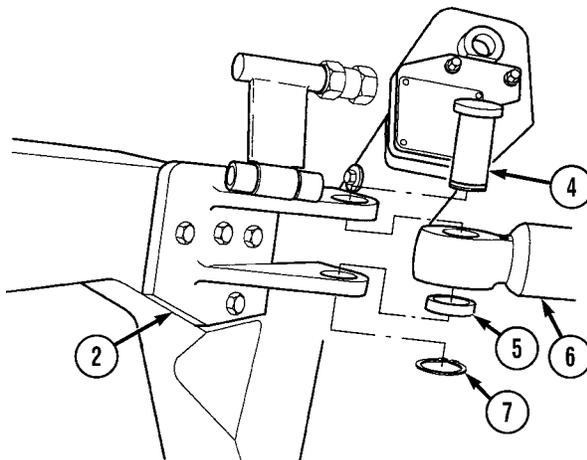

f. Adjustment.

NOTE

- Make sure slider arm is deployed.
- Both flip lock brackets are adjusted the same way. Right side shown.

- (1) Remove quick release pin (1) and pin (2) from short strut (3) and long strut (4).
- (2) Soldier A and Soldier B using handle of arm assembly (5), rotate arm assembly out and separate short strut (3) from long strut (4).
- (3) Soldier A holding arm assembly (5) out, position flip lock (6) up.

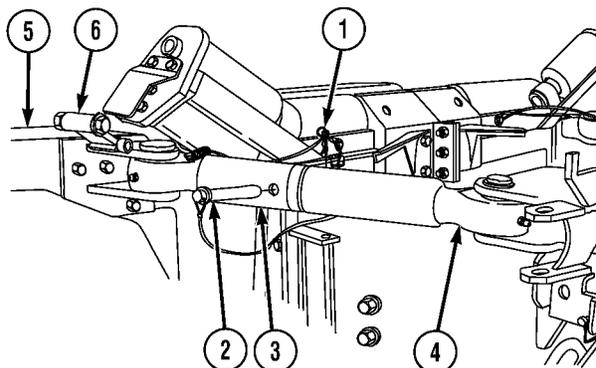

Organizational Maintenance Instructions (Cont)

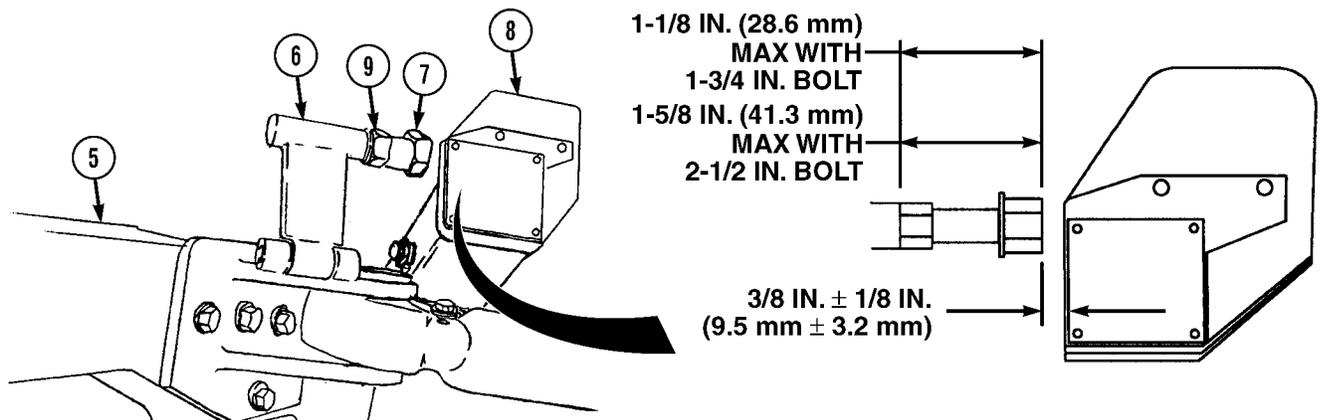

- (4) Measure gap between stop bolt (7) and right rear roller bracket (8).

NOTE

- If gap is not $3/8 \pm 1/8$ in. (9.5 ± 3.2 mm), perform steps (5) and (6).
- If gap is $3/8 \pm 1/8$ in. (9.5 ± 3.2 mm), go to step (8).
- If dimension of gap is greater than 1.25 in. (3.18 cm) following adjustment or proper adjustment cannot be done, replace stop bolt with 2.50-in. (6.35 cm) long stop bolt.

- (5) Loosen jam nut (9) and adjust stop bolt (7) as required.
 (6) Tighten jam nut (9) on stop bolt (7).
 (7) If proper adjustment could not be made, repeat steps (3) through (6) using longer bolt.
 (8) Aline long strut (4) with short strut (3).
 (9) Using handle of arm assembly (5), rotate arm assembly out and release flip lock (6).
 (10) Position long strut (4) into short strut (3) and install pin (2) and quick release pin (1).
 (11) Repeat steps (1) through (10) for left side.

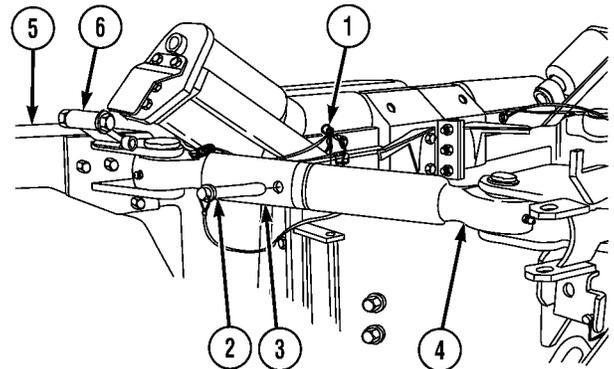

g. Follow-on Maintenance.

- (1) Lubricate rear slider arm (Para 3-2).
 (2) Remove wheel chocks (TM 9-2320-279-10).

END OF TASK

Organizational Maintenance Instructions (Cont)

4-53.5 CONTAINER HANDLING UNIT (CHU) REAR BRACKET ASSEMBLY REPLACEMENT.

This task covers:

- | | | |
|----------------|------------------------|--------------------------|
| a. Removal | c. Cleaning/Inspection | e. Installation |
| b. Disassembly | d. Assembly | f. Follow-on Maintenance |

INITIAL SETUP

Models

M1120

References

None

Test Equipment

None

Equipment Condition

<i>TM or Para</i>	<i>Condition Description</i>
TM 9-2320-279-10	Engine OFF

Special Tools

Tool Kit, General Mechanic's: Automotive, Item 33, Appendix B
Lifting Device, Minimum Capacity 140 lbs. (64 kg)

TM 9-2320-279-10	Wheels chocked
Para 4-53.2	Slider removed
Para 4-53.4	Slider arm removed
Para 4-43.1	Light bar and brackets removed

Supplies

Sealing Compound, Item 16, Appendix F
Locknut (2), Item 1, Appendix K
Locknut (16), Item 3, Appendix K (left side only)
Locknut (17), Item 3, Appendix K (right side only)
Locknut (2), Item 3.2, Appendix K

TM 9-2320-279-10	Rear splash guard assembly removed
Para 4-46	Horizontal roller removed
Para 4-47	Angled roller removed

Special Environmental Conditions

None

Personnel Required

MOS 63S, Heavy wheel vehicle mechanic (2)

General Safety Instructions

None

Organizational Maintenance Instructions (Cont)

a. Removal.

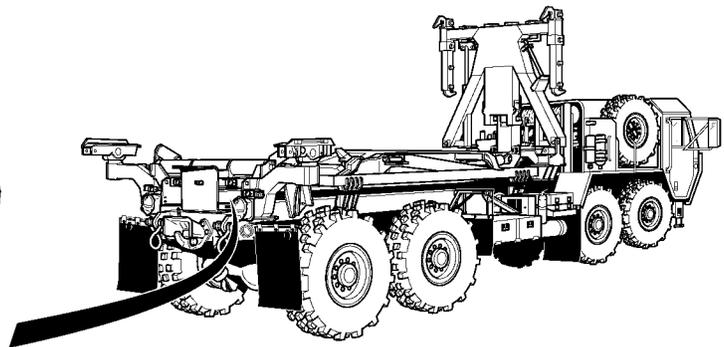
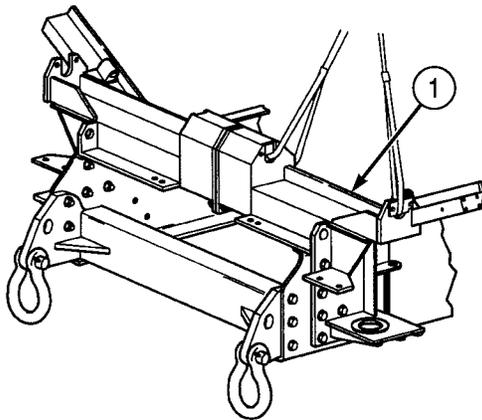
**WARNING**

Rear roller bracket weighs 150 lbs. (68 kg). When removing one rear roller bracket, make sure remaining rear roller bracket is supported. Attach suitable lifting device to prevent possible injury to personnel.

NOTE

- Right rear roller bracket and left rear roller bracket are identical unless noted.
- Right rear roller bracket is shown.

(1) Attach lifting device to rear roller bracket (1).

NOTE

Note quantity of shims prior to removal.

(2) Remove six screws (2), locknuts (3), and shim(s) (4) from rear roller bracket (5) and left rear roller bracket (6). Discard locknuts.

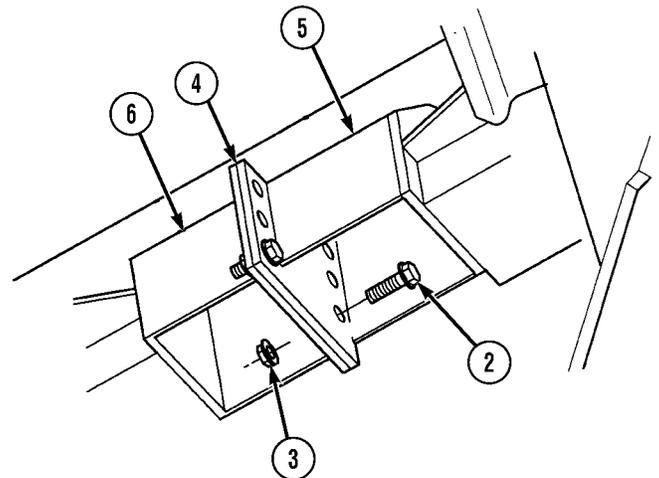

Organizational Maintenance Instructions (Cont)

4-53.5 CONTAINER HANDLING UNIT (CHU) REAR BRACKET ASSEMBLY REPLACEMENT (CONT).

NOTE

Perform step (3) for right side of truck only.

- (3) Remove locknut (7), two washers (8), and screw (9) from rear roller bracket (5). Discard locknut.
- (4) Soldier A and Soldier B remove five screws (10) and locknuts (11) from rear roller bracket (5), frame (12), and rear crossmember (13). Discard locknuts.
- (5) Soldier A and Soldier B remove five screws (14) and locknuts (15) from rear roller bracket (5) and frame (12).
- (6) Soldier A and Soldier B remove rear roller bracket (5) from truck.
- (7) Remove lifting device from rear roller bracket (5).

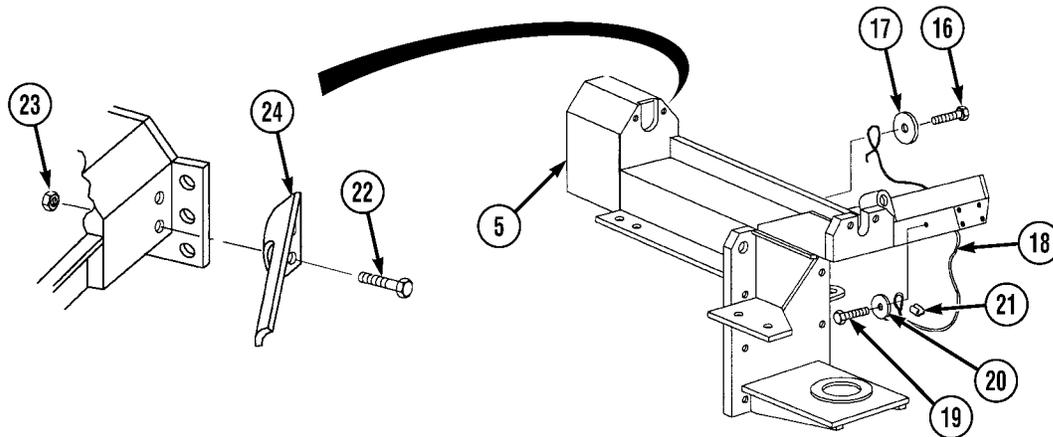
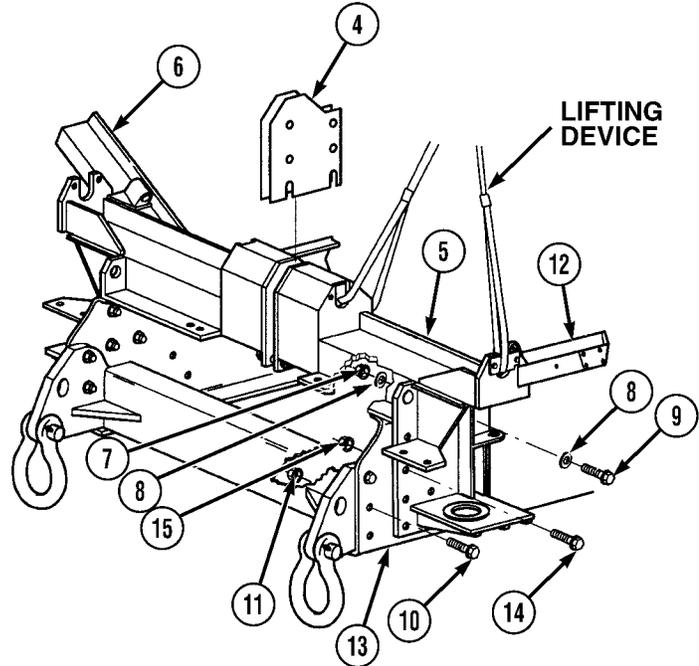

- (8) Remove screw (16), washer (17), and wire rope (18) from rear roller bracket (5).
- (9) Remove screw (19), washer (20), and wire rope (18) from rear roller bracket (5).

NOTE

Perform step (10) if wire rope is damaged.

- (10) Remove swaging sleeve (21) from wire rope (18).
- (11) Remove two screws (22), locknuts (23), and stow plate (24) from rear roller bracket (5). Discard locknuts.

Organizational Maintenance Instructions (Cont)

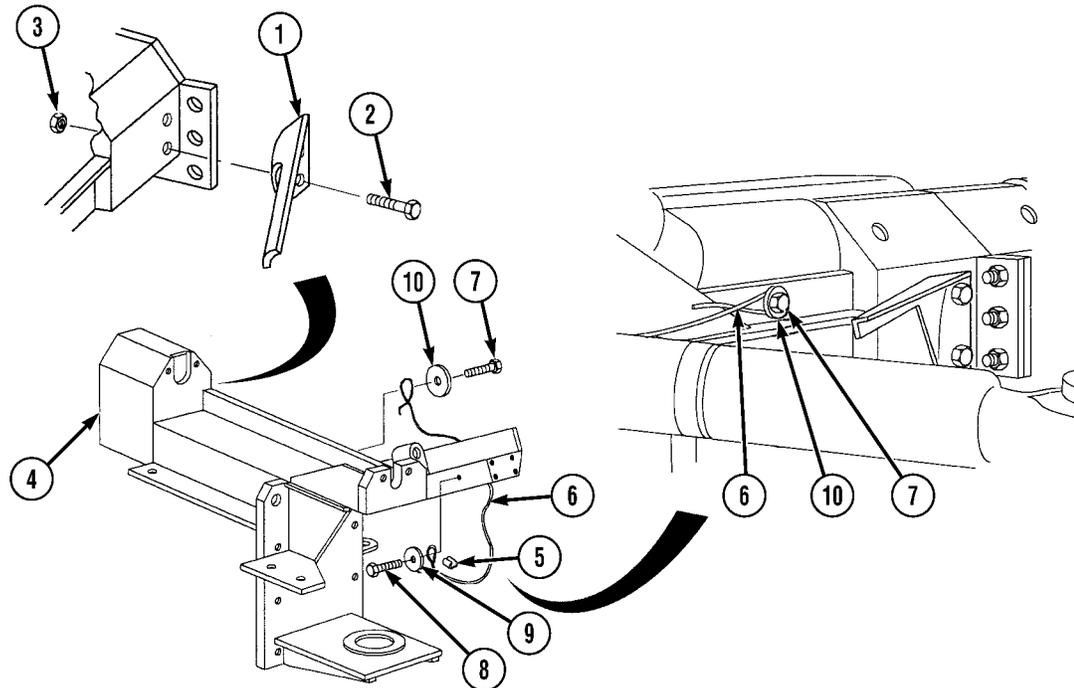
b. Installation.**NOTE**

- Right rear roller bracket and left rear roller bracket are identical unless noted.
- Right rear roller bracket is shown.

- (1) Position stow plate (1), two screws (2), and locknuts (3) to rear roller bracket (4). Do not tighten screws.

NOTE

Perform step (2) if wire rope was removed.

- (2) Install swaging sleeve (5) to wire rope (6).

WARNING

Adhesives, solvents, and sealing compounds can burn easily, can give off harmful vapors, and are harmful to skin and clothing. To avoid injury or death, keep away from open fire and use in well-ventilated area. If adhesive, solvent, or sealing compound gets on skin or clothing, wash immediately with soap and water.

- (3) Apply sealing compound to threads of screw (7) and screw (8).
 (4) Install screw (8), washer (9), and loop end of wire rope (6) on rear roller bracket (4). Do not tighten screw.
 (5) Position screw (7), washer (10), and end of wire rope (6) on rear roller bracket (4).

NOTE

Wire must be pulled tight against roller bracket when installed.

- (6) Wrap wire rope (6) around screw (7) and under washer (10) and tighten screw (7) and screw (8).

Organizational Maintenance Instructions (Cont)

4-53.5 CONTAINER HANDLING UNIT (CHU) REAR BRACKET ASSEMBLY REPLACEMENT (CONT).

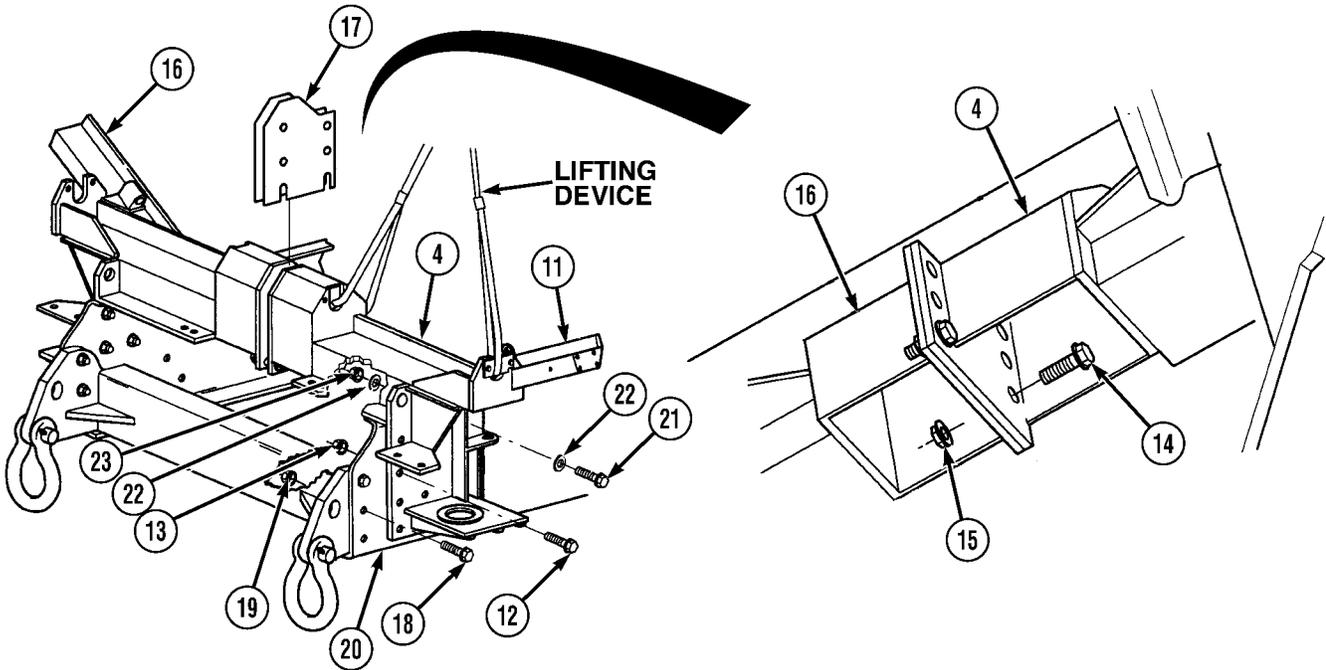

WARNING

Rear roller bracket weighs 150 lbs. (68 kg). When removing one rear roller bracket, make sure remaining rear roller bracket is supported. Attach suitable lifting device to prevent possible injury to personnel.

- (7) Attach lifting device to rear roller bracket (4).
- (8) Soldier A and Soldier B position rear roller bracket (4) on frame (11) and secure with five screws (12) and locknuts (13). Do not tighten screws.
- (9) Position bottom two screws (14) and locknuts (15) at center split of right rear roller bracket (4) and left rear roller bracket (16) to maintain alinement.

NOTE

Install shims as noted during removal.

- (10) Position shim(s) (17), if required, in center split and install remaining four screws (14) and locknuts (15).
- (11) Soldier A and Soldier B position five screws (18) and locknuts (19) on rear roller bracket (4) truck frame (11) and rear crossmember (20).

NOTE

Perform step (12) for right side only.

- (12) Install screw (21), two washers (22), and locknut (23) on rear roller bracket (4).
- (13) Tighten six locknuts (15) on screws (14).
- (14) Tighten ten locknuts (13) and (19) on screws (12) and (18).
- (15) Remove lifting device from rear roller bracket (4).
- (16) Install slider arm (Para 4-53.4).
- (17) Install slider (Para 4-53.2).

Organizational Maintenance Instructions (Cont)

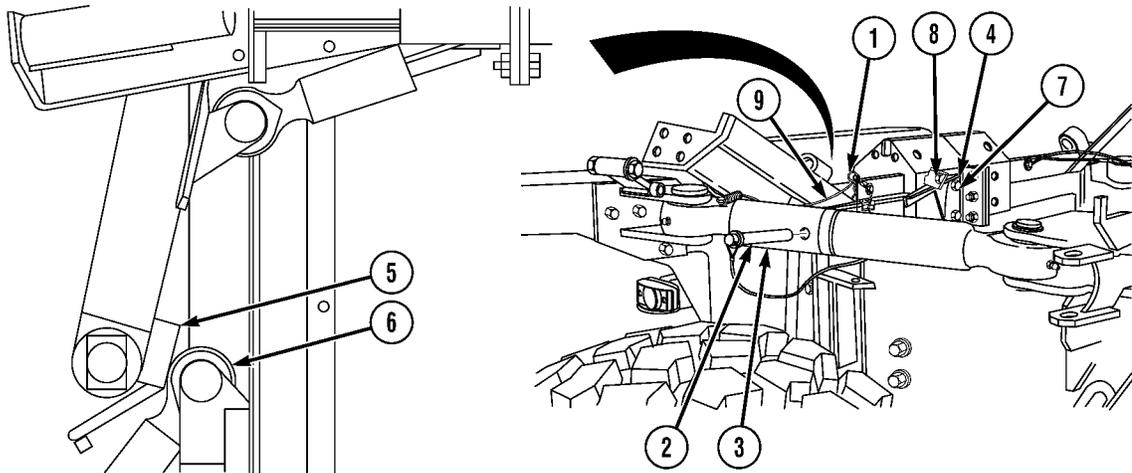
c. Adjustment.

**SLIDERS SHOWN
REMOVED FOR CLARITY**

NOTE

Both stow plates and wire ropes are adjusted the same way. Right side shown.

- (1) Remove quick release pin (1) and pin (2) from short strut (3).

NOTE

- Stow plate should be positioned in center of short strut.
 - Make sure slider arm is fully stowed and slider arm handle contacts long strut prior to tightening screws.
- (2) Position short strut (3) on stow plate (4) in stowed position and make sure that handle of arm assembly (5) contacts long strut (6).
 - (3) Tighten two screws (7) and locknuts (8) on stow plate (4).
 - (4) Make sure wire rope (9) is tight.

d. Follow-on Maintenance:

- (1) Install angled roller (Para 4-47).
- (2) Install horizontal roller (Para 4-46).
- (3) Install rear splash guard (TM 9-2320-279-10).
- (4) Install light bar and brackets (Para 4-43.1).
- (5) Remove wheel chocks (TM 9-2320-279-10).

END OF TASK

Organizational Maintenance Instructions (Cont)

4-53.6 CONTAINER HANDLING UNIT (CHU) LONG STRUT BRACKET ASSEMBLY REPAIR.

This task covers:

- | | | |
|------------------------|-----------------|--------------------------|
| a. Removal | d. Assembly | f. Adjustment |
| b. Disassembly | e. Installation | g. Follow-on Maintenance |
| c. Cleaning/Inspection | | |

INITIAL SETUP

Models

M1120

Personnel Required

MOS 63S, Heavy wheel vehicle mechanic (2)

Test Equipment

None

References

None

Special Tools

Tool Kit, General Mechanic's: Automotive, Item 33, Appendix B
 Compressor Unit, Air, Item 2.2, Appendix B
 Gloves, Chemical Oil Protective, Item 11, Appendix B
 Goggles, Industrial, Item 12, Appendix B
 Gun, Air Blow, Item 12.1, Appendix B
 Pliers, Retaining Ring, Item 19.1, Appendix B
 Puller Kit, Universal, Item 19.2, Appendix B

Equipment Condition

<i>TM or Para</i>	<i>Condition Description</i>
TM 9-2320-279-10	Engine OFF
TM 9-2320-279-10	Wheels chocked
Para 2-10.1	Slider arm in container mode

Special Environmental Conditions

None

General Safety Instructions

None

Supplies

Antiseize Compound, Item 6.1, Appendix F
 Sealing Compound, Item 16, Appendix F
 Locknut (4), Item 2.1, Appendix K
 Locknut (4), Item 3, Appendix K

Organizational Maintenance Instructions (Cont)

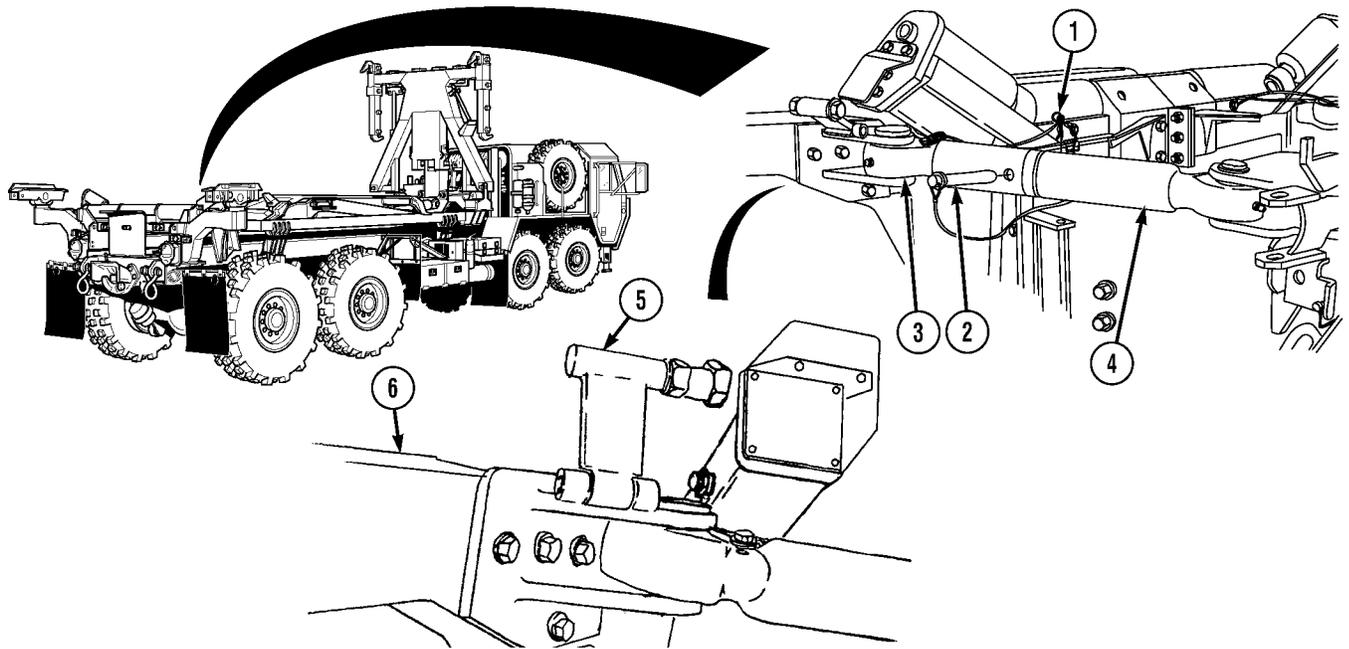
a. Removal.**NOTE**

There are two long strut bracket assemblies. Both are removed the same way. Right side is shown.

- (1) Remove quick release pin (1) and pin (2) from short strut (3) and long strut (4).
- (2) Position flip lock (5) up to hold arm assembly (6) out.

Organizational Maintenance Instructions (Cont)

4-53.6 CONTAINER HANDLING UNIT (CHU) LONG STRUT BRACKET ASSEMBLY REPAIR (CONT).

WARNING

Use care when removing snap and retaining rings. Snap and retaining rings are under spring tension and can act as projectiles when released and could cause severe eye injury.

- (3) Remove retaining ring (7), spacer (8), pin (9), and long strut (4) from bracket assembly (10).
- (4) Remove left long strut (4).

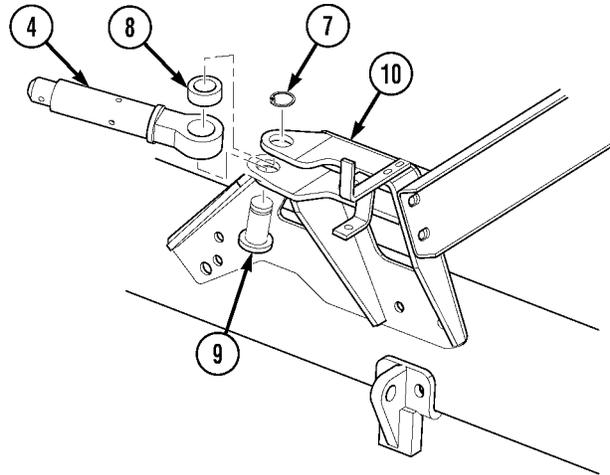

WARNING

Each strut bracket assembly weighs 30 lbs. (13.61kg) and cross bracket weighs 530 lbs. (240.40 kg). Attach suitable lifting device to prevent possible injury to personnel.

- (5) Remove two screws (11), locknuts (12), and cross support bracket (13) from left support strut bracket (14) and right support strut bracket (15).
- (6) Remove five nuts (16), five screws (17) and right support strut bracket (15) from frame (19).
- (7) Remove five nuts (16), five screws (17), rear ladder bracket (18), and left support strut bracket (14) from frame (19).

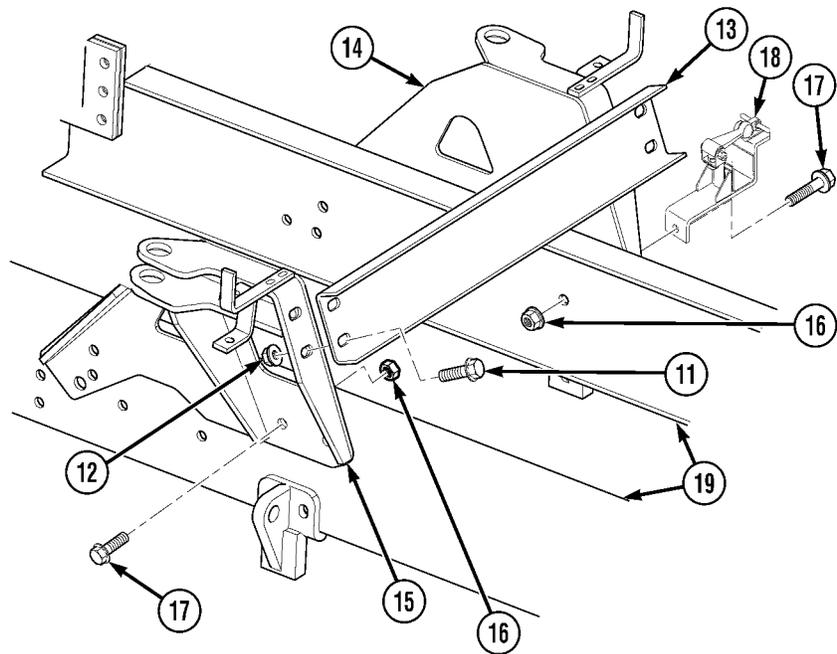

Organizational Maintenance Instructions (Cont)

b. Disassembly.

- (1) Remove grease fitting (1) from end of long strut (2).

WARNING

Use care when removing snap and retaining rings. Snap and retaining rings are under spring tension and can act as projectiles when released and could cause severe eye injury.

- (2) Remove retaining ring (3), spacer (4), and bearing (5) from long strut (2).
 (3) Remove wire rope (6), quick release pin (7), and pin (8) from cushion clip (9).

NOTE

Perform step (4) if wire rope is damaged.

- (4) Remove two swaging sleeves (10) from wire rope (6).

NOTE

- Perform steps (5) and (6) if pin end is damaged.
 - Screw is used to secure pin end to long strut.
 - Note position of pin end prior to removal.
- (5) Remove screw (11) and cushion clip (9) from long strut (2).
 (6) Remove pin end (12) from end of long strut (2).

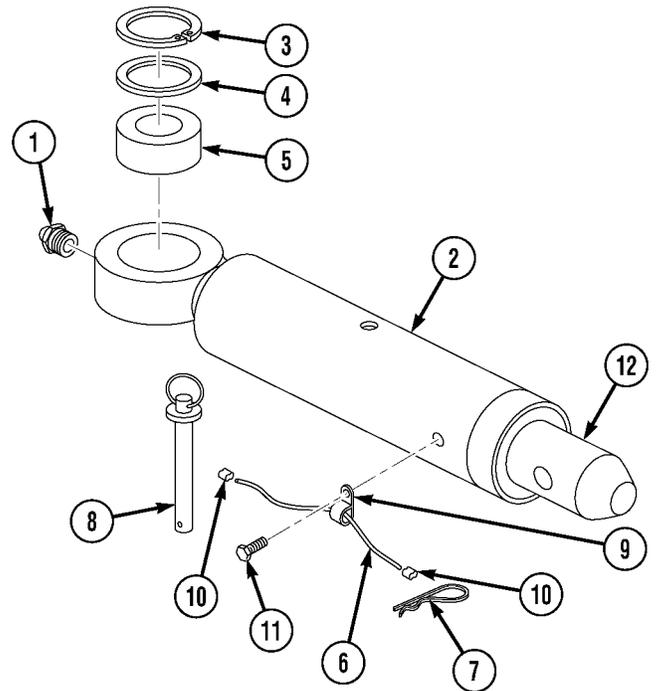

Organizational Maintenance Instructions (Cont)

4-53.6 CONTAINER HANDLING UNIT (CHU) LONG STRUT BRACKET ASSEMBLY REPAIR (CONT).

c. Cleaning/Inspection.

WARNING

- Drycleaning Solvent (P-D-680) is TOXIC and flammable. Wear protective goggles, face shield, and gloves; use only in a well-ventilated area; avoid contact with skin, eyes, and clothes; and do not breathe vapors. Keep away from heat or flame. Never smoke when using solvent. The flashpoint for Type III Drycleaning Solvent is 200°F (93°C). Failure to do so may result in injury or death to personnel.
- If personnel become dizzy while using cleaning solvent, immediately get fresh air and medical help. If solvent contacts skin or clothes, flush with cold water. If solvent contacts eyes, immediately flush eyes with water and get immediate medical attention.

- (1) Clean all metal parts with drycleaning solvent.

WARNING

Compressed air used for cleaning purposes shall not exceed 30 psi (207 kPa). Use only with effective chip guarding and personal protective equipment (goggles/shield, gloves, etc.), or injury to personnel may result.

- (2) Dry parts with compressed air.
- (3) Inspect parts for breaks, cracks, burrs, and sharp edges. Look for unusual signs of wear on strut.
- (4) Replace all damaged parts.

Organizational Maintenance Instructions (Cont)

d. Assembly.

WARNING

Adhesives, solvents, and sealing compounds can burn easily, can give off harmful vapors, and are harmful to skin and clothing. To avoid injury or death, keep away from open fire and use in well-ventilated area. If adhesive, solvent, or sealing compound gets on skin or clothing, wash immediately with soap and water.

NOTE

- Perform steps (1) through (4) if pin end was removed.
- If strut bracket and/or long strut is being replaced, refer to **f. Adjustment**.
- Position pin end in long strut as noted during disassembly.

- (1) Apply antiseize compound to threads of pin end (1).
- (2) Position pin end (1) in end of long strut (2).
- (3) Position cushion clip (3) on pin (4), lock pin (5), wire rope (6), and swaging sleeves (7).
- (4) Position cushion clip (3) and screw (8) on long strut (2).

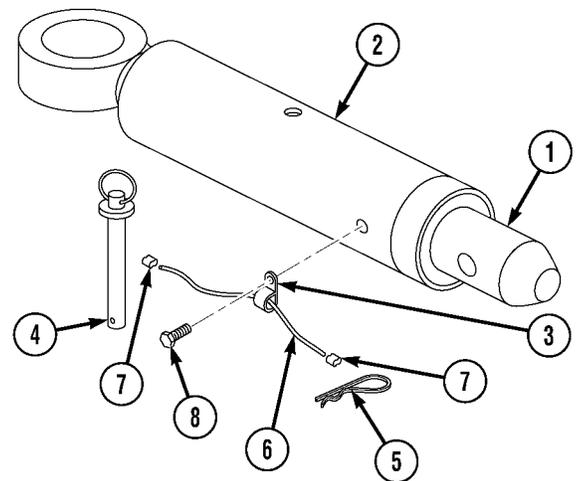

- (5) Apply antiseize compound to outer surface of bearing (9).

WARNING

Use care when installing snap and retaining rings. Snap and retaining rings are under spring tension and can act as projectiles when released and could cause severe eye injury.

- (6) Install bearing (9), spacer (10), and retaining ring (11) in bore of long strut (2).
- (7) Install grease fitting (12) in long strut (2).

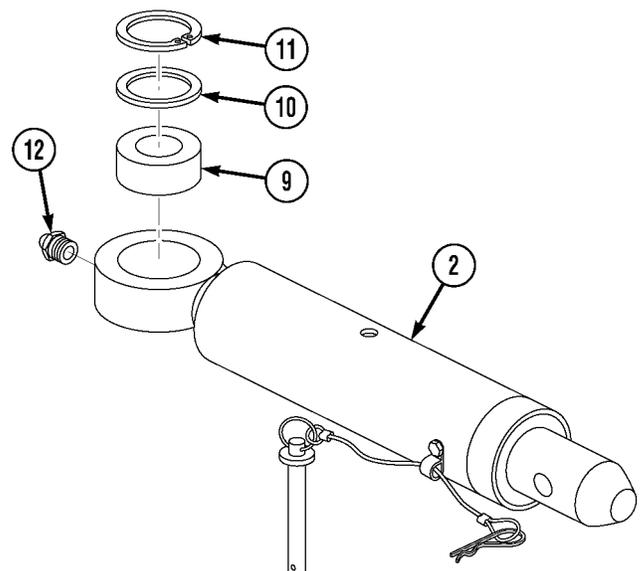

Organizational Maintenance Instructions (Cont)

4-53.6 CONTAINER HANDLING UNIT (CHU) LONG STRUT BRACKET ASSEMBLY REPAIR (CONT).

e. Installation.

- (1) Install right strut support bracket (1) on frame (2) with five screws (3) and nuts (4). Tighten nuts.
- (2) Install left strut support bracket (5) and rear ladder bracket (6) on frame (2) with five screws (3) and nuts (4). Tighten nuts.
- (3) Install cross support brace (7) on right strut support bracket (1) and left strut support bracket (5) with four screws (8) and nuts (9). Tighten nuts.

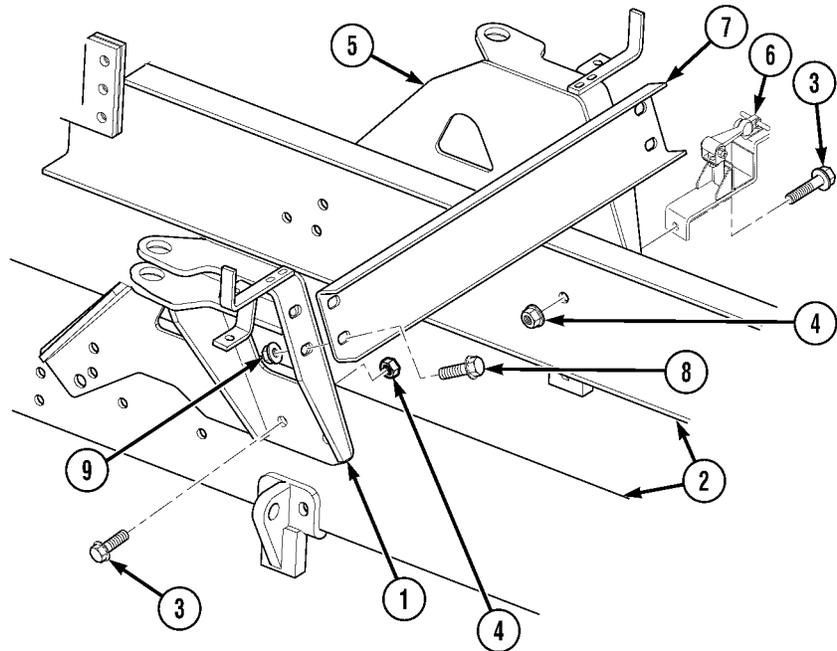

WARNING

Use care when installing snap and retaining rings. Snap and retaining rings are under spring tension and can act as projectiles when released and could cause eye injury.

NOTE

Beveled edge of spacer faces bearing in long strut.

- (4) Install long strut (10) and spacer (11) in bracket assembly (12) with pin (13) and retaining ring (14).

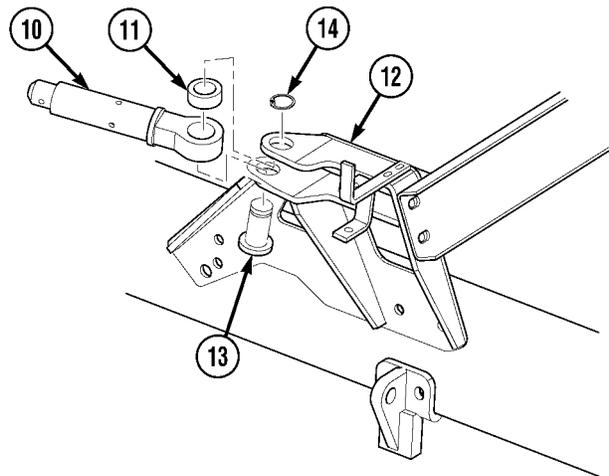

Organizational Maintenance Instructions (Cont)

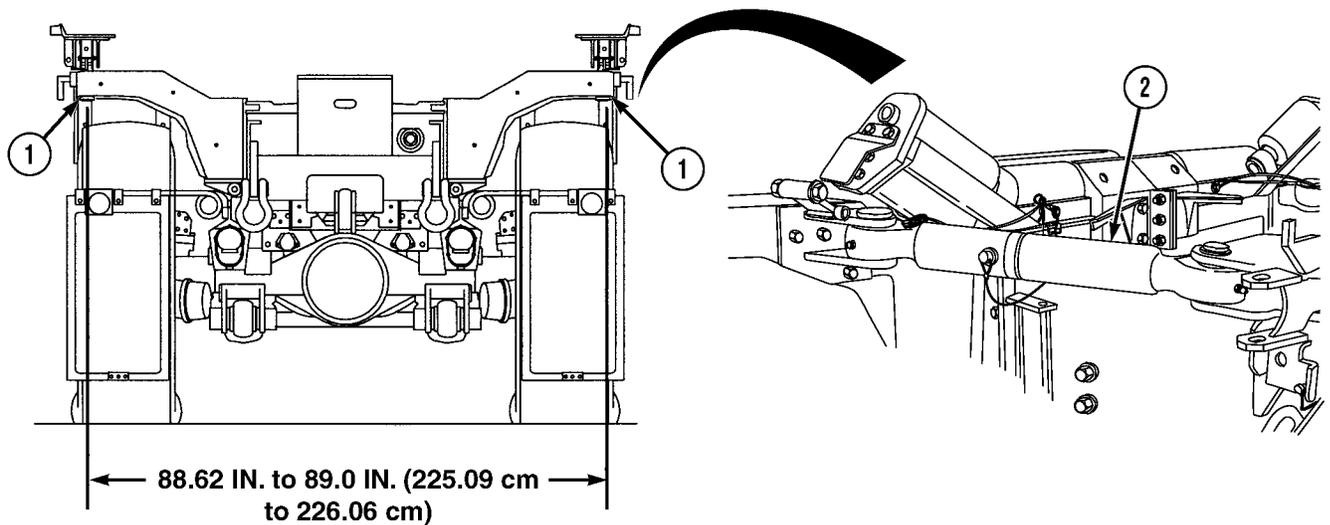
f. Adjustment.

- (1) Deploy both slider assemblies by extending short and long struts (TM 9-2320-279-10).
- (2) Soldier A and Soldier B measure distance between center of slider pivot pins (1).

NOTE

- Adjustment of struts is performed in steps (4) through (13).
 - If distance measured is 88.62 to 89 in. (225.09 to 226.06 cm), no adjustment is required.
- (3) Adjust long struts (2) so distance measured is 88.62 to 89 in. (225.09 to 226.06 cm) between slider pivot pin (1) centers.

Organizational Maintenance Instructions (Cont)

4-53.6 CONTAINER HANDLING UNIT (CHU) LONG STRUT BRACKET ASSEMBLY REPAIR (CONT).

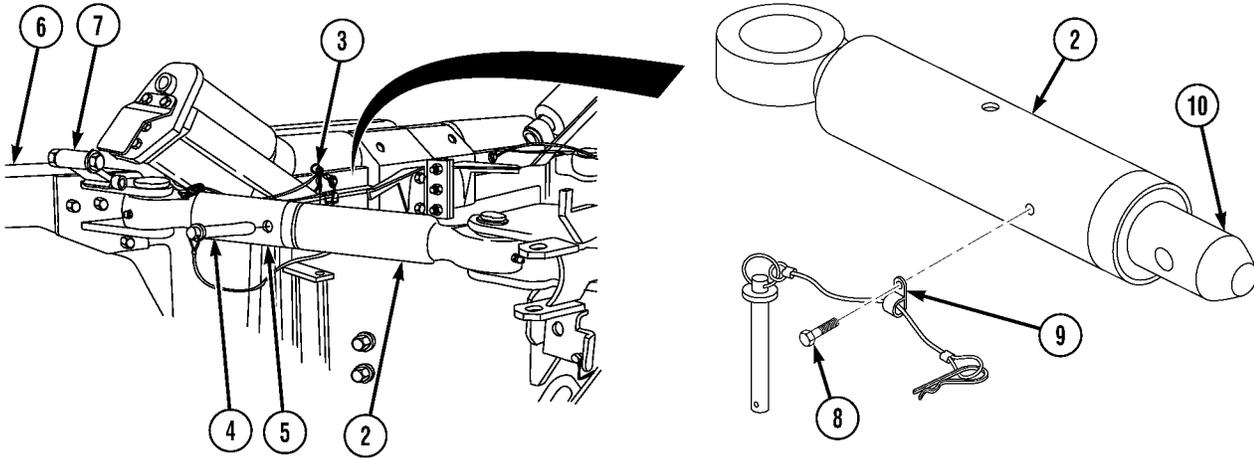

- (4) Remove quick release pin (3) and pin (4) from short strut (5) and long strut (2).
- (5) Using handle of arm assembly (6), rotate arm assembly out to separate short strut (5) and long strut (2).
- (6) Position flip lock (7) up to hold arm assembly (6) out. Release arm assembly.

NOTE

- Rotating pin end of long strut counterclockwise 1/2 turn will decrease width measurement by approximately 1/16 in. (1.59 mm).
- Rotating pin end of long strut clockwise 1/2 turn will increase width measurement by approximately 1/16 in. (1.59 mm).
- Adjust both RH and LH long struts equally to obtain the correct width measurement.

- (7) Remove screw (8) and cushion clip (9) from long strut (2).

CAUTION

Do not unscrew pin end too far. Gap between long strut tube and pin end flange should not exceed 0.75 in. (19 mm). Failure to have sufficient engagement of pin end into long strut could result in damage to equipment.

- (8) Rotate pin end (10) as required for correct width measurement.

Organizational Maintenance Instructions (Cont)

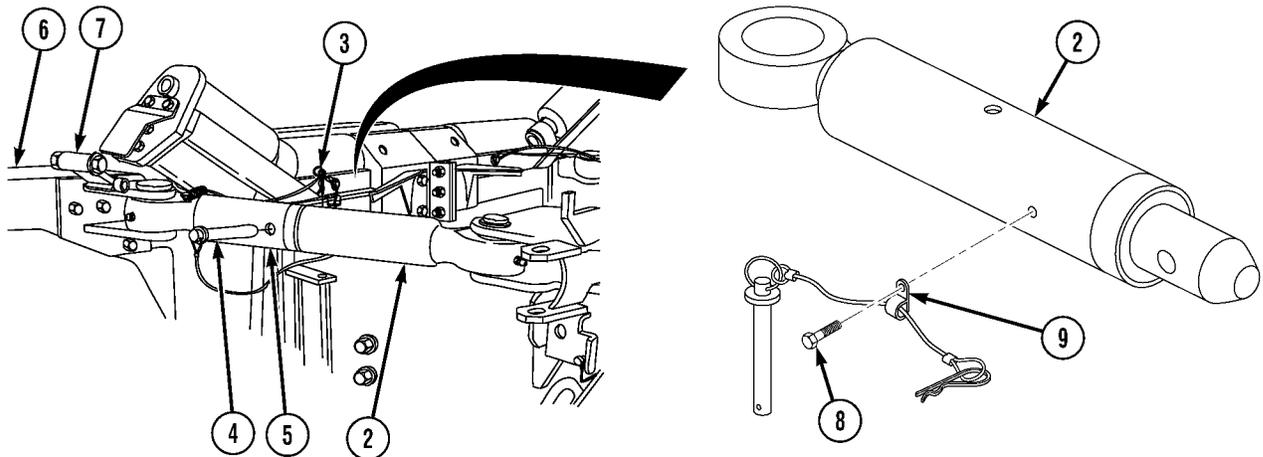
**WARNING**

Adhesives, solvents, and sealing compounds can burn easily, can give off harmful vapors, and are harmful to skin and clothing. To avoid injury or death, keep away from open fire and use in well-ventilated area. If adhesive, solvent, or sealing compound gets on skin or clothing, wash immediately with soap and water.

NOTE

Make sure hole in pin end align with hole for cushion clip.

- (9) Apply sealing compound (Loctite 242) to threads of screw (8).
- (10) Install screw (8) and cushion clip (9) to long strut (2).
- (11) Aline long strut (2) with short strut (5).
- (12) Using handle of arm assembly (6), rotate arm assembly and disengage flip lock (7).
- (13) Position long strut (2) in short strut (5) and install pin (4) and quick release pin (3).
- (14) Repeat steps (4) through (13) for left side.
- (15) Repeat steps (2) through (14) as necessary.

g. Follow-on Maintenance. Remove wheel chocks (TM 9-2320-279-10).

END OF TASK

Organizational Maintenance Instructions (Cont)

4-53.7 CONTAINER HANDLING UNIT (CHU) STOWAGE TRAY REPLACEMENT.

This task covers:

- | | |
|------------------------|--------------------------|
| a. Removal | c. Installation |
| b. Cleaning/Inspection | d. Follow-on Maintenance |

INITIAL SETUP

Models

M1120

Personnel Required

MOS 63S, Heavy wheel vehicle mechanic (2)

Test Equipment

None

References

None

Special Tools

Tool Kit, General Mechanic's: Automotive, Item 33, Appendix B
 Compressor Unit, Air, Item 2.2, Appendix B
 Gloves, Chemical Oil Protective, Item 11, Appendix B
 Goggles, Industrial, Item 12, Appendix B
 Gun, Air Blow, Item 12.1, Appendix B
 Lifting Device, Minimum Capacity 400 lbs. (181 kg)

Equipment Condition

<i>TM or Para</i>	<i>Condition Description</i>
TM 9-2320-279-10	Engine OFF
TM 9-2320-279-10	Wheels chocked
Para 2-10.11	Rail transport corner ISO locks removed
Para 2-10.1	Container guides removed

Special Environmental Conditions

None

Supplies

Locknut (4), Item 1, Appendix K

General Safety Instructions

None

Organizational Maintenance Instructions (Cont)

a. Removal.

WARNING

Stowage tray weights 72 lbs. (32.66 kg). Attach suitable lifting device to prevent possible injury to personnel.

- (1) Attach lifting device to stowage tray (1).
- (2) Support stowage tray (1) and remove four screws (2) and locknuts (3) from stowage tray and front CHU support crossmember (4). Discard locknuts.
- (3) Remove stowage tray (1) from front CHU support crossmember (4).
- (4) Position stowage tray (1) on clean work surface.
- (5) Remove lifting device from stowage tray (1).

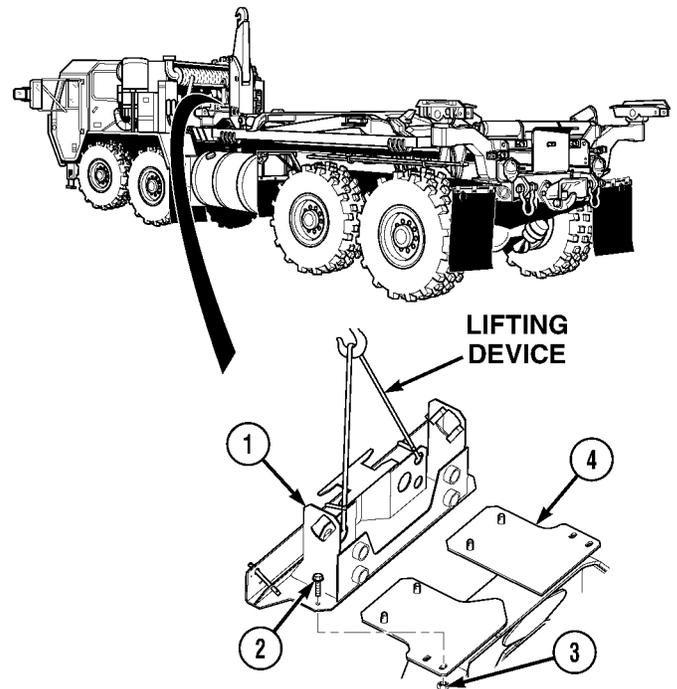

b. Cleaning/Inspection.

WARNING

- Drycleaning Solvent (P-D-680) is TOXIC and flammable. Wear protective goggles, face shield, and gloves; use only in a well-ventilated area; avoid contact with skin, eyes, and clothes; and do not breathe vapors. Keep away from heat or flame. Never smoke when using solvent. The flashpoint for Type III Drycleaning Solvent is 200°F (93°C). Failure to do so may result in injury or death to personnel.
- If personnel become dizzy while using cleaning solvent, immediately get fresh air and medical help. If solvent contacts skin or clothes, flush with cold water. If solvent contacts eyes, immediately flush eyes with water and get immediate medical attention.

- (1) Clean all metal parts with drycleaning solvent.

WARNING

Compressed air used for cleaning purposes shall not exceed 30 psi (207 kPa). Use only with effective chip guarding and personal protective equipment (goggles/shield, gloves, etc.), or injury to personnel may result.

- (2) Dry parts with compressed air.
- (3) Inspect parts for breaks, cracks, burrs, and sharp edges. Look for unusual signs of wear on stowage tray.
- (4) Replace all damaged parts.

Organizational Maintenance Instructions (Cont)

4-53.7 CONTAINER HANDLING UNIT (CHU) STOWAGE TRAY REPLACEMENT (CONT).

c. Installation.

- (1) Attach suitable lifting device to stowage tray (1).
- (2) While Soldier B controls lifting device, Soldier A positions stowage tray (1) on front CHU support crossmember (2).
- (3) Install four screws (3) and locknut (4) on stowage tray (1) and front CHU support crossmember (2). Tighten locknuts.
- (4) Remove lifting device from stowage tray (1).

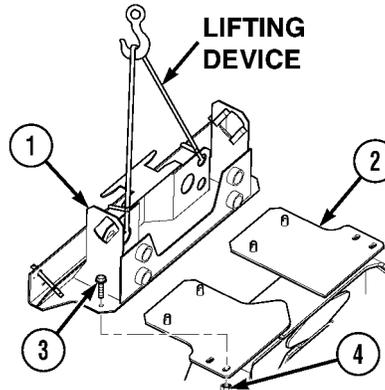

d. Follow-on Maintenance.

- (1) Install rail transport corner ISO locks (Para 2-10.11).
- (2) Install container guides (Para 2-10.1).
- (3) Remove wheel chocks (TM 9-2320-279-10).

END OF TASK

Organizational Maintenance Instructions (Cont)

4-53.8 CONTAINER HANDLING UNIT (CHU) FRONT LIFT ADAPTER ASSEMBLY REPLACEMENT.		
This task covers:		
a. Removal	b. Installation	c. Follow-on Maintenance
INITIAL SETUP		
<i>Models</i> M1120	<i>References</i> None	
<i>Test Equipment</i> None	<i>Equipment Condition</i>	
<i>Special Tools</i> Tool Kit, General Mechanic's: Automotive, Item 33, Appendix B	<i>TM or Para</i> Para 2-10.2 Para 2-10.11	<i>Condition Description</i> Front lift adapter in 82 in. (208 cm) mode Front lift adapter removed from truck
<i>Supplies</i> Sealing Compound, Item 16, Appendix F	<i>Special Environmental Conditions</i> None	
<i>Personnel Required</i> MOS 63S, Heavy wheel vehicle mechanic (2)	<i>General Safety Instructions</i> None	

Organizational Maintenance Instructions (Cont)

4-53.8 CONTAINER HANDLING UNIT (CHU) FRONT LIFT ADAPTER ASSEMBLY REPLACEMENT (CONT).

a. Removal.

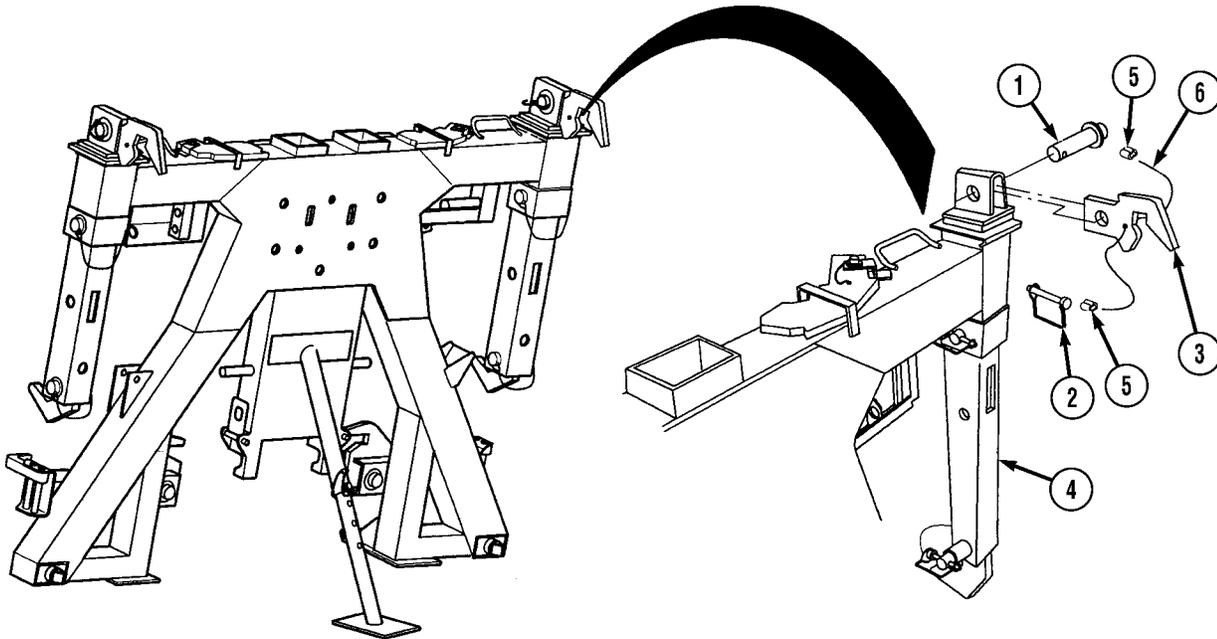

NOTE

- There are two slide arms. Both are removed the same way. Right side is shown.
- Only remove wire ropes, swaging sleeves, pins, and lock pins if components are damaged.

- (1) Remove pin (1), lock pin (2), and upper hook (3) from slide arm (4).
- (2) Remove two swaging sleeves (5) and wire rope (6) from pin (1) and lock pin (2).
- (3) Remove lock pin (7) and pin (8) from front lift adapter stow bracket (9).
- (4) Remove two swaging sleeves (10) and wire rope (11) from pin (8) and lock pin (7).

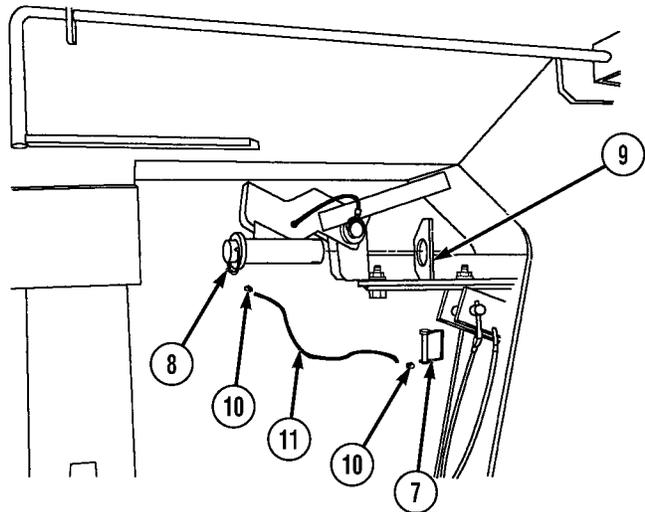

Organizational Maintenance Instructions (Cont)

- (5) Remove lock pin (12), collar (13), pin (14), and lifting hook (15) from slide arm (4).
- (6) Remove two swaging sleeves (16) and wire rope (17) from pin (14) and lock pin (12).

WARNING

Slide arm weighs 65 lbs. (29 kg). Attach suitable lifting device to prevent possible injury to personnel.

- (7) Attach lifting device to slide arm (4).
- (8) Soldier A and Soldier B remove slide arm (4) from front lift adapter (18).
- (9) Remove lifting device from slide arm (4).

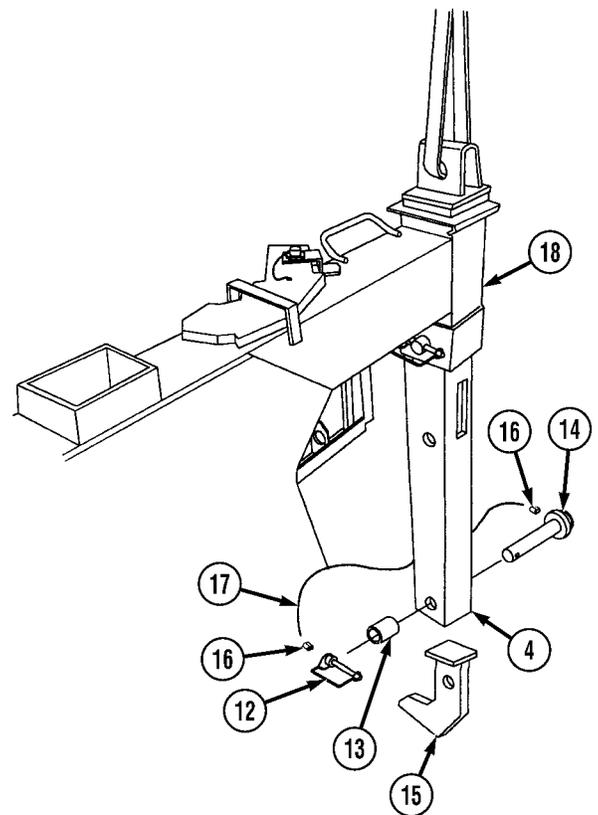

Organizational Maintenance Instructions (Cont)

4-53.8 CONTAINER HANDLING UNIT (CHU) FRONT LIFT ADAPTER ASSEMBLY REPLACEMENT (CONT).

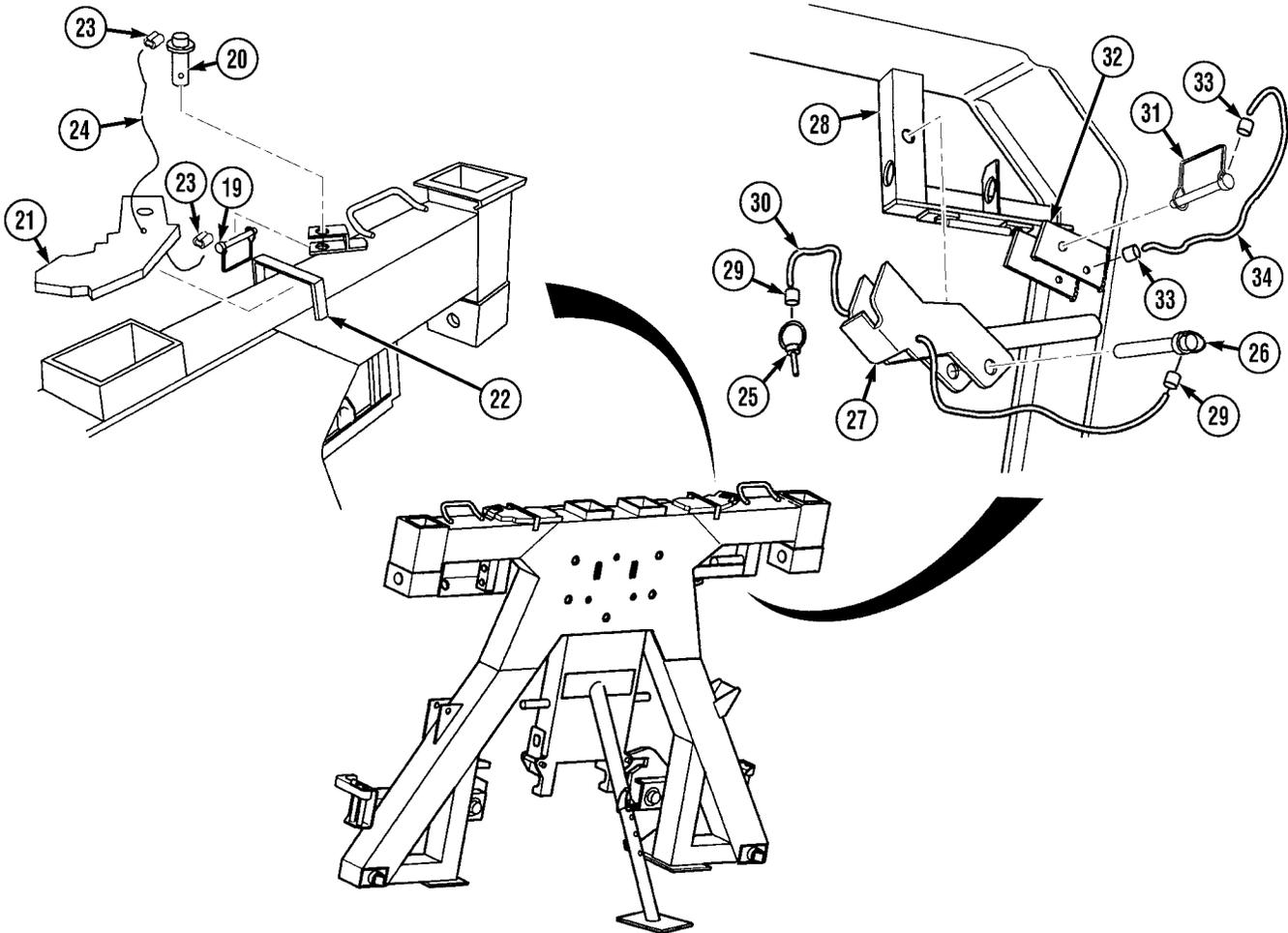

NOTE

There are two 6-ft (1.82 m) hooks. Both are removed the same way. Right side is shown.

- (10) Remove lock pin (19), pin (20), and 6-ft (1.82 m) hook (21) from front lift adapter stow bracket (22).
- (11) Remove two swaging sleeves (23) and wire rope (24) from 6-ft (1.82 m) hook (21), pin (20), and lock pin (19).
- (12) Remove lock pin (25), pin (26), and bail bar lock (27) from front lift adapter stow bracket (28).
- (13) Remove two swaging sleeves (29) and wire rope (30) from bail bar lock (27), pin (26), and lock pin (25).
- (14) Remove lock pin (31) from front lift adapter stow bracket (32).
- (15) Remove two swaging sleeves (33) and wire rope (34) from front lift adapter stow bracket (32) and lock pin (31).

Organizational Maintenance Instructions (Cont)

NOTE

There are two container locks and half height container hooks. Both are removed the same way. Right side is shown.

- (16) Remove lock pin (35), pin (36), and container lock (37) from front lift adapter stow bracket (38).
- (17) Remove two swaging sleeves (39) and wire rope (40) from container lock (37), pin (36), and lock pin (35).
- (18) Remove lock pin (41), pin (42), and half height container hook (43) from front lift adapter stow bracket (38).
- (19) Remove two swaging sleeves (44) and wire rope (45) from half height container hook (43), pin (42), and lock pin (41).

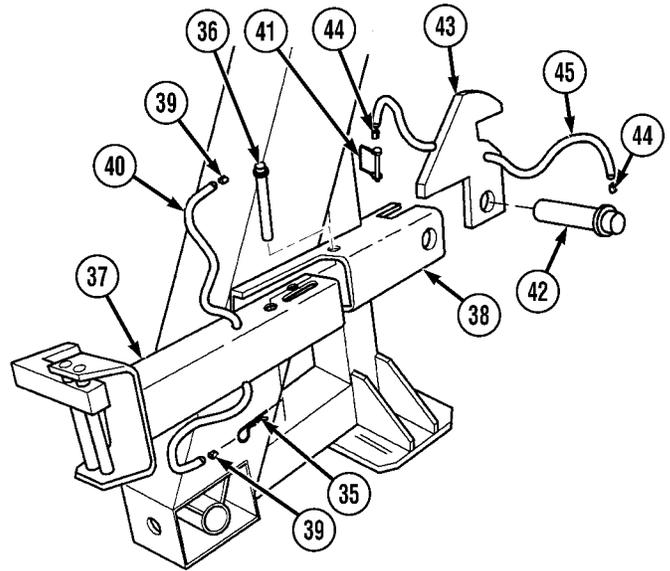

- (20) Remove four screws (46) and two long wear pads (47) from front lift adapter (18).
- (21) Remove four screws (48) and two short wear pads (49) from front lift adapter (18).
- (22) Remove four screws (50) and two short wear pads (51) from front lift adapter (18).

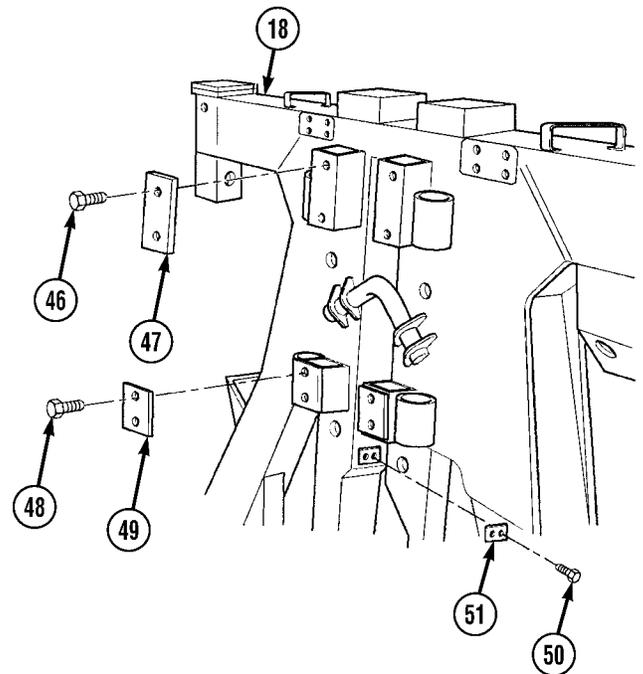

Organizational Maintenance Instructions (Cont)

4-53.8 CONTAINER HANDLING UNIT (CHU) FRONT LIFT ADAPTER ASSEMBLY REPLACEMENT (CONT).

WARNING

Front lift adapter weighs 1,600 lbs. (726 kg). Attach suitable lifting device to prevent possible injury to personnel.

- (23) Attach lifting device to front lift adapter (18).
- (24) Soldier A and Soldier B lift and support front lift adapter (18).

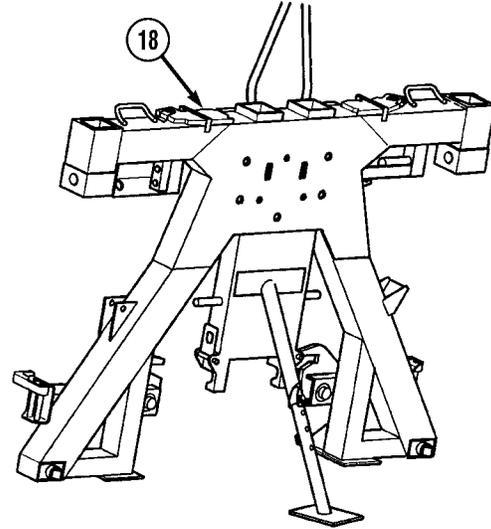

- (25) Support lower half of support leg (52) and remove lock pin (53) and pin (54).
- (26) Remove lower half of support leg (52) from upper half of support leg (55).
- (27) Soldier A and Soldier B support upper half of support leg (55) and remove two lock pins (56) from upper half of support leg and front lift adapter (18).
- (28) Remove upper half of support leg (55) from front lift adapter (18).
- (29) Lower front lift adapter (18) to ground and remove lifting device.

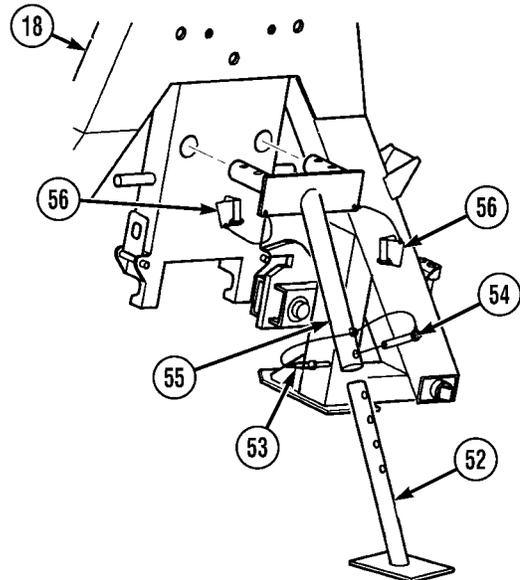

Organizational Maintenance Instructions (Cont)

- (30) Remove two swaging sleeves (57) and wire rope (58) from lock pin (53), pin (54), and upper half of support leg (55).
- (31) Remove four swaging sleeves (59) and two wire ropes (60) from two lock pins (56) and upper half of support leg (55).

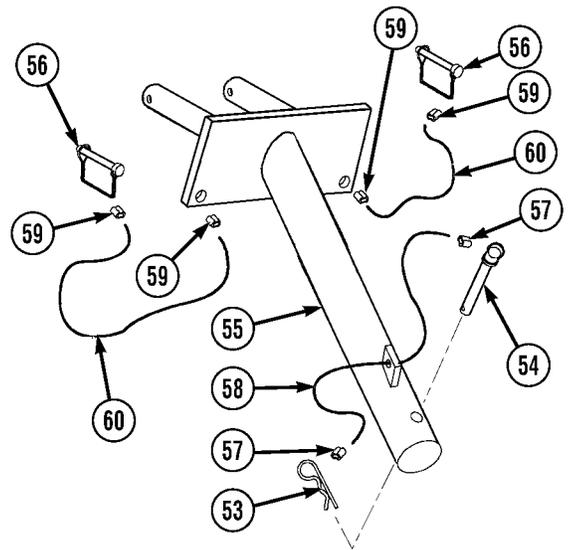

b. Installation.

NOTE

Install wire ropes, swaging sleeves, pins, and lock pins only if removed.

- (1) Install two lock pins (1) with wire ropes (2) and four swaging sleeves (3) on upper half of support leg (4).
- (2) Install pin (5) and lock pin (6) with wire rope (7) and two swaging sleeves (8) on upper half of support leg (4).

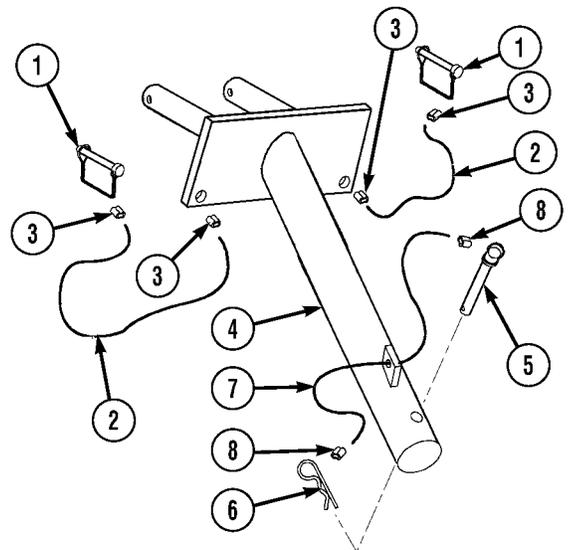

Organizational Maintenance Instructions (Cont)

4-53.8 CONTAINER HANDLING UNIT (CHU) FRONT LIFT ADAPTER ASSEMBLY REPLACEMENT (CONT).

WARNING

Front lift adapter weighs 1,600 lbs. (726 kg). Attach suitable lifting device to prevent possible injury to personnel.

- (3) Attach lifting device to front lift adapter (9).
- (4) Soldier A and Soldier B lift and support front lift adapter (9).
- (5) Soldier A and Soldier B install upper half of support leg (4) on front lift adapter (9) with two lock pins (1).
- (6) Install lower half of support leg (10) on upper half of support leg (4) with pin (5) and lock pin (6).

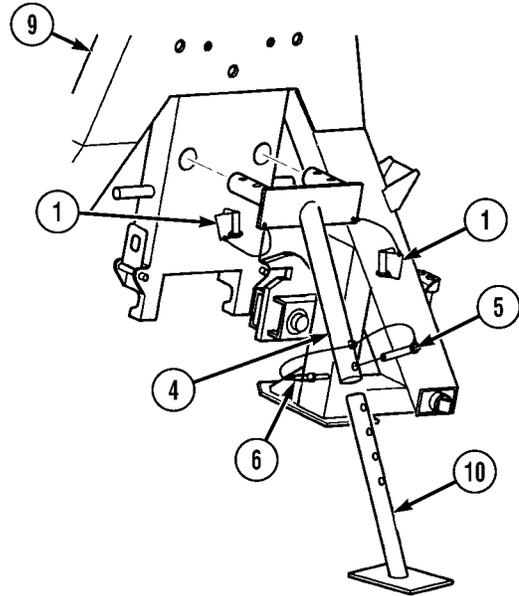

- (7) With lifting device, position front lift adapter (9) on ground.
- (8) Remove lifting device from front lift adapter (9).

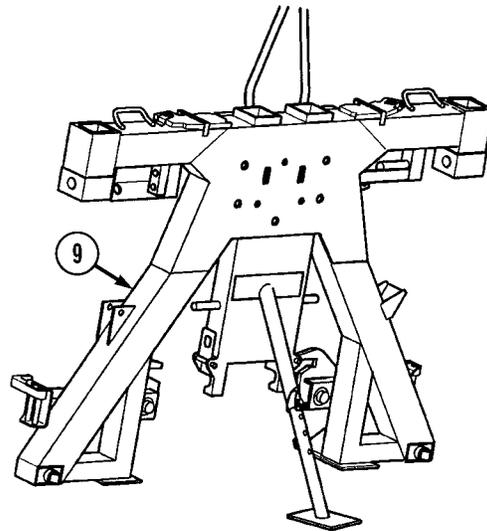

Organizational Maintenance Instructions (Cont)

WARNING

Adhesives, solvents, and sealing compounds can burn easily, can give off harmful vapors, and are harmful to skin and clothing. To avoid injury or death, keep away from open fire and use in well-ventilated area. If adhesive, solvent, or sealing compound gets on skin or clothing, wash immediately with soap and water.

- (9) Apply sealing compound to threads of 12 screws (11), (12), and (13).
- (10) Install two short wear pads (14) to front lift adapter (9) with four screws (13).
- (11) Install two short wear pads (15) to front lift adapter (9) with four screws (12).
- (12) Install two long wear pads (16) to front lift adapter (9) with four screws (11).

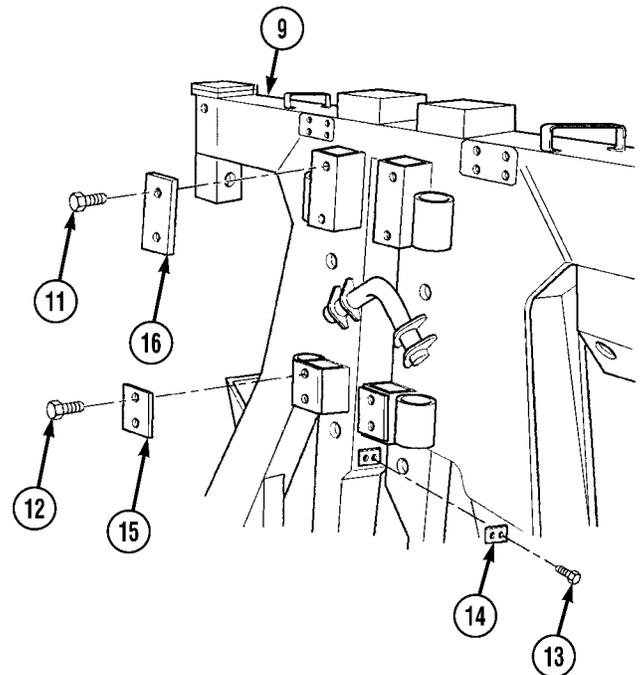
**NOTE**

There are two container locks and half height container hooks. Both are installed the same way. Right side is shown.

- (13) Install pin (17) and lock pin (18) with wire rope (19) and swaging sleeves (20) on half height container hook (21).
- (14) Install half height container hook (21) on front lift adapter stow bracket (22) with pin (17) and lock pin (18).
- (15) Install pin (23) and lock pin (24) with wire rope (25) and swaging sleeves (26) on container lock (27).
- (16) Install container lock (27) on front lift adapter stow bracket (22) with pin (23) and lock pin (24).

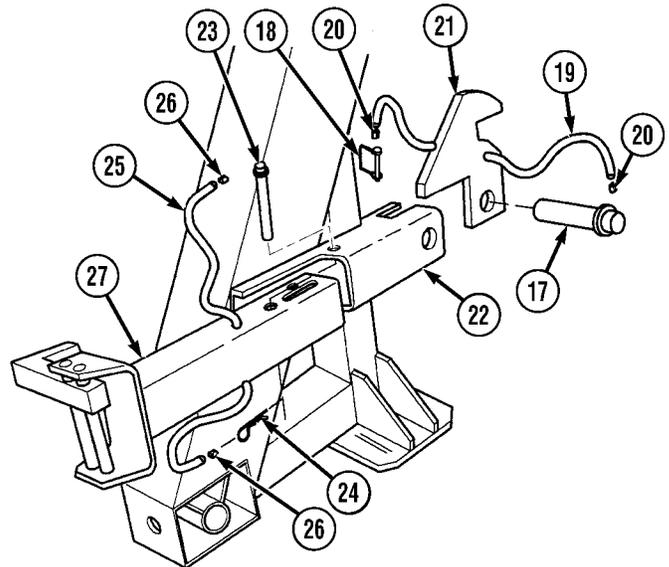

Organizational Maintenance Instructions (Cont)

4-53.8 CONTAINER HANDLING UNIT (CHU) FRONT LIFT ADAPTER ASSEMBLY REPLACEMENT (CONT).

- (17) Install lock pin (28) with wire rope (29) and swaging sleeves (30) on front lift adapter stow bracket (31).
- (18) Install pin (33) and lock pin (34) with wire rope (35) and swaging sleeves (36) on bail bar lock (37).
- (19) Install bail bar lock (37) on front lift adapter stow bracket (32) with pin (33) and lock pin (34).

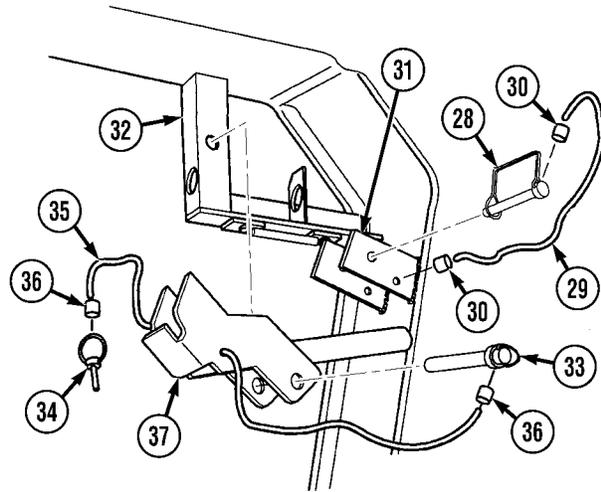

NOTE

There are two 6-ft (1.8 m) hooks. Both are installed the same way. Right side is shown.

- (20) Install pin (38) and lock pin (39) with wire rope (40) and swaging sleeves (41) on 6-ft (1.8 m) hook (42).
- (21) Install 6-ft (1.8 m) hook (42) on front lift adapter stow bracket (43) with pin (38) and lock pin (39).

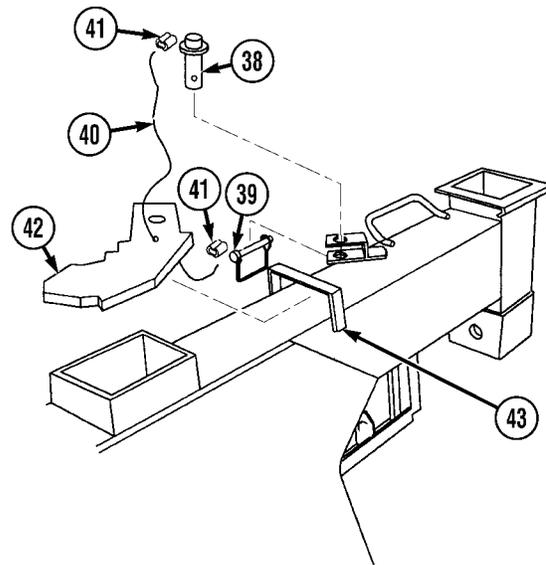

Organizational Maintenance Instructions (Cont)

WARNING

Slide arm weighs 65 lbs. (29 kg). Attach suitable lifting device to prevent possible injury to personnel.

- (22) Attach lifting device to slide arm (44).
- (23) Soldier A and Soldier B position slide arm (44) on front lift adapter (9).
- (24) Install wire rope (45) and swaging sleeves (46) on pin (47) and lockpin (48).
- (25) Install lifting hook (49) on slide arm (44) with pin (47), collar (50), and lock pin (48).

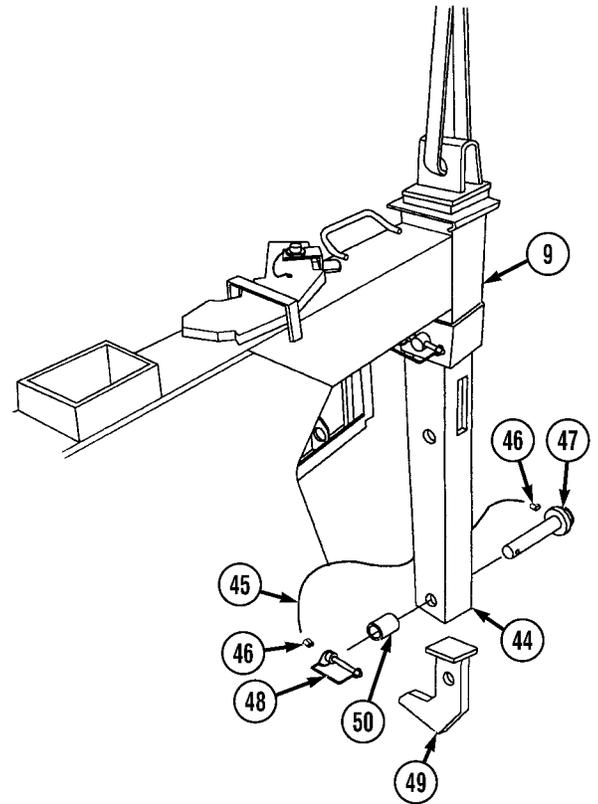

- (26) Install pin (51) and lock pin (52) with wire rope (53) and two swaging sleeves (54) on front lift adapter stow bracket (55).

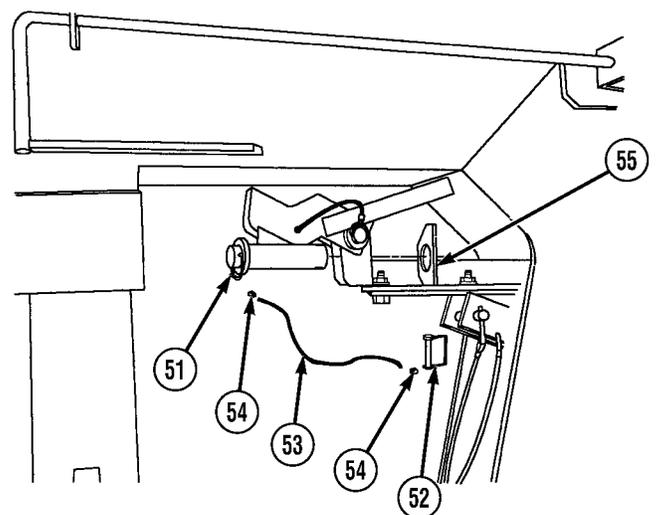

Organizational Maintenance Instructions (Cont)

4-53.8 CONTAINER HANDLING UNIT (CHU) FRONT LIFT ADAPTER ASSEMBLY REPLACEMENT (CONT).

- (27) Install pin (56) and lock pin (57) with wire rope (58) and two swaging sleeves (59) on upper hook (60).
- (28) Install upper hook (60) on slide arm (44) with pin (56) and lock pin (57).

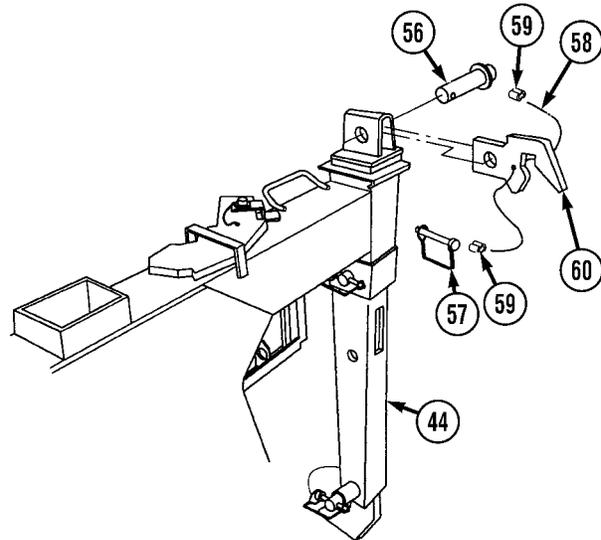

c. Follow-on Maintenance.

- (1) Lubricate front lift adapter (Para 3-2).
- (2) Install front lift adapter on truck (Para 2-10.11).
- (3) Remove wheel chocks (TM 9-2320-279-10).

END OF TASK

Organizational Maintenance Instructions (Cont)

4-53.9 CONTAINER HANDLING UNIT (CHU) FRONT LIFT ADAPTER LOCKING PLATE ASSEMBLY REPLACEMENT.		
This task covers:		
a. Removal	b. Installation	c. Follow-on Maintenance
INITIAL SETUP		
<i>Models</i> M1120	<i>References</i> None	
<i>Test Equipment</i> None	<i>Equipment Condition</i>	
<i>Special Tools</i> Tool Kit, General Mechanic's: Automotive, Item 33, Appendix B	<i>TM or Para</i> Para 2-10.11	<i>Condition Description</i> Front lift adapter removed from truck
<i>Supplies</i> Pin, Cotter (2), Item 31.1, Appendix K	TM 9-2320-279-10	Engine OFF
<i>Personnel Required</i> MOS 63S, Heavy wheel vehicle mechanic	TM 9-2320-279-10	Wheels chocked
	<i>Special Environmental Conditions</i> None	
	<i>General Safety Instructions</i> None	

Organizational Maintenance Instructions (Cont)

4-53.9 CONTAINER HANDLING UNIT (CHU) FRONT LIFT ADAPTER LOCKING PLATE ASSEMBLY REPLACEMENT (CONT).

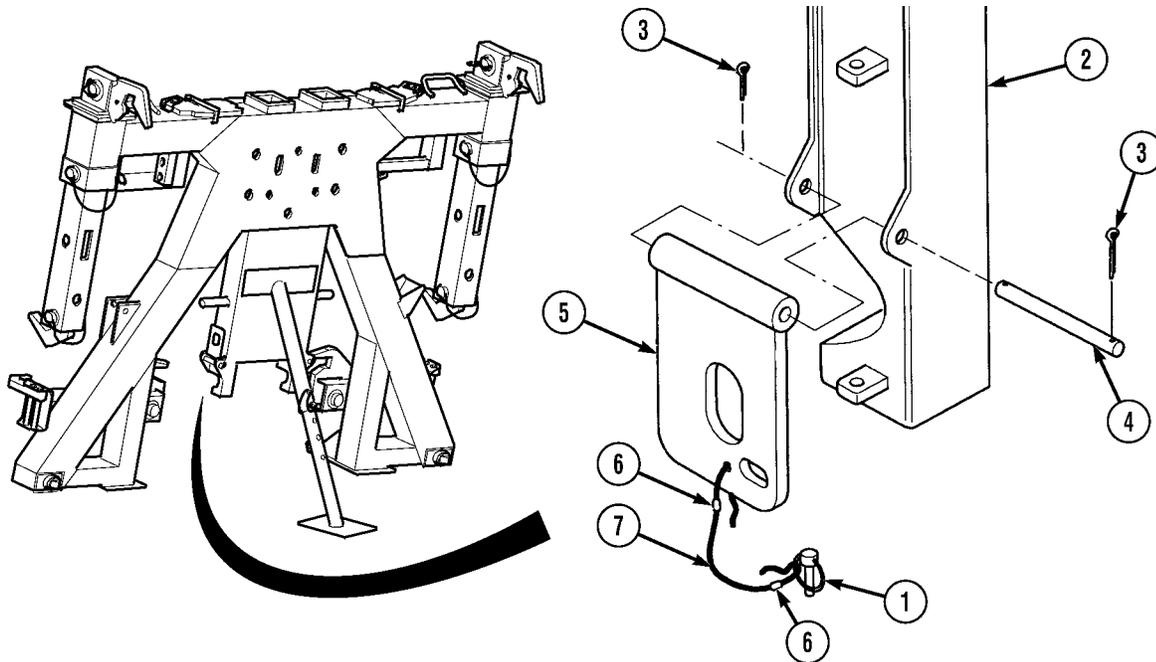

a. Removal.

NOTE

There are two locking plate assemblies. Both are installed the same way. Left side is shown.

- (1) Remove quick release pin (1) from front lift adapter (2).
- (2) Remove two cotter pins (3), hinge pin (4), and locking plate (5) from front lift adapter (2). Discard cotter pins.

NOTE

Perform step (3) if wire rope or pins are damaged.

- (3) Remove two swaging sleeves (6), wire rope (7), and quick release pin (1) from locking plate (5).

b. Installation.

NOTE

- There are two locking plate assemblies. Both are installed the same way. Left side is shown.
- Perform step (1) if wire rope or pins were removed.

- (1) Install wire rope (7) to quick release pin (1) and locking plate (5) with two swaging sleeves (6).
- (2) Install locking plate (5) on front lift adapter (2) with hinge pin (4) and two cotter pins (3).
- (3) Install quick release pin (1) on front lift adapter (2).

c. Follow-on Maintenance.

- (1) Lubricate locking plate (TM 9-2320-279-10).
- (2) Install front lift adapter on truck (Para 2-10.11).
- (3) Remove wheel chocks (TM 9-2320-279-10).

END OF TASK

Organizational Maintenance Instructions (Cont)

4-53.10 SELF-RECOVERY WINCH (SRW) CONTAINER HANDLING UNIT (CHU) REAR GUIDE REPLACEMENT.		
This task covers:		
a. Removal	b. Installation	c. Follow-on Maintenance
INITIAL SETUP		
<i>Models</i> M1120	<i>Personnel Required</i> MOS 63S, Heavy wheel vehicle mechanic (2)	
<i>Test Equipment</i> None	<i>References</i> None	
<i>Special Tools</i> Tool Kit, General Mechanic's: Automotive, Item 33, Appendix B Lifting Device, Minimum Capacity 70 lbs. (32 kg)	<i>Equipment Condition</i> <i>TM or Para</i> <i>Condition Description</i> TM 9-2320-279-10 Engine OFF TM 9-2320-279-10 Wheels chocked	
<i>Supplies</i> Sealing Compound, Item 16, Appendix F Locknut (4), Item 2.1, Appendix K Locknut, Item 3.1, Appendix K Lockwasher (2), Item 14.1, Appendix K	<i>Special Environmental Conditions</i> None <i>General Safety Instructions</i> None	

Organizational Maintenance Instructions (Cont)

4-53.10 SELF-RECOVERY WINCH (SRW) CONTAINER HANDLING UNIT (CHU) REAR GUIDE REPLACEMENT (CONT).

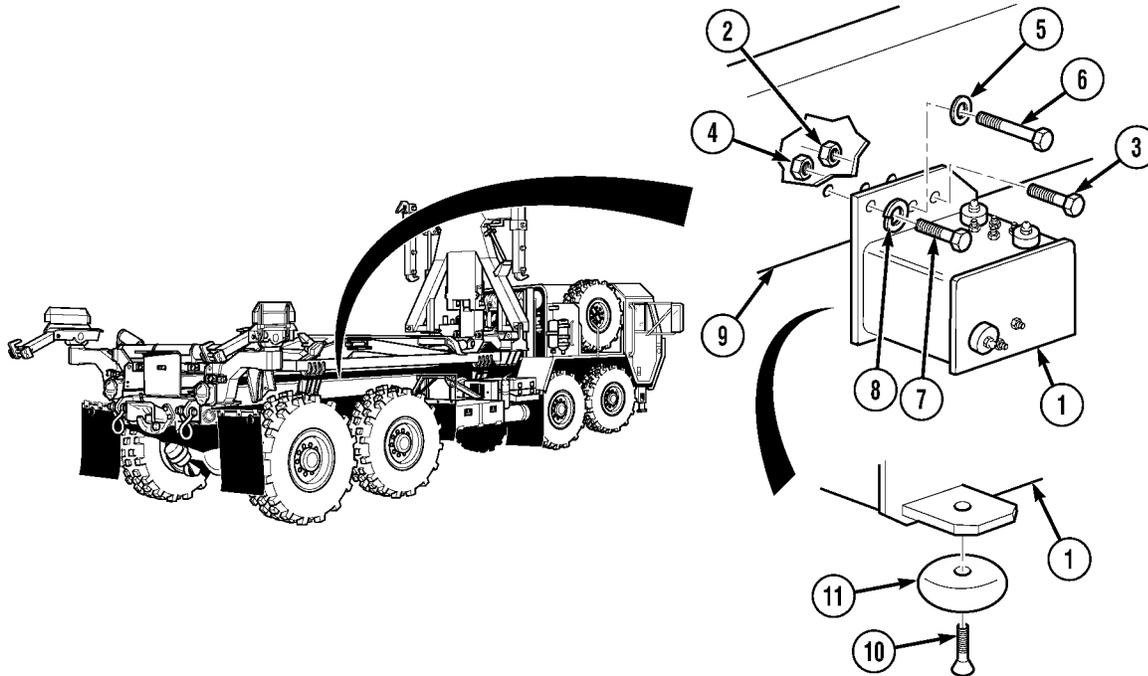

a. Removal.

WARNING

Rear guide assembly weighs 70 lbs. (32 kg). Attach suitable lifting device to prevent possible injury to personnel.

- (1) Attach lifting device to rear guide (1).
- (2) Soldier A and Soldier B remove four locknuts (2) and screws (3) from rear guide (1). Discard locknuts.
- (3) Soldier A and Soldier B remove locknut (4), washer (5), and screw (6) from rear guide (1). Discard locknut.
- (4) Soldier A and Soldier B remove two screws (7), lockwashers (8), and rear guide (1) from frame (9). Discard lockwashers.
- (5) Position rear guide (1) on clean work surface and remove lifting device.
- (6) Remove screw (10) and axle stop (11) from rear guide (1).

Organizational Maintenance Instructions (Cont)

b. Installation.**WARNING**

Adhesives, solvents, and sealing compounds can burn easily, can give off harmful vapors, and are harmful to skin and clothing. To avoid injury or death, keep away from open fire and use in well-ventilated area. If adhesive, solvent, or sealing compound gets on skin or clothing, wash immediately with soap and water.

- (1) Apply sealing compound to threads of screw (1).
- (2) Install screw (1) and axle stop (2) on rear guide (3).

WARNING

Rear guide assembly weighs 70 lbs. (32 kg). Attach suitable lifting device to prevent possible injury to personnel.

- (3) Attach lifting device to rear guide (3).
- (4) Soldier A and Soldier B position rear guide (3) on frame (4) with two lockwashers (5) and screws (6).
- (5) Install screw (7), washer (8), and locknut (9) on rear guide (3).
- (6) Soldier A and Soldier B position four locknuts (10) and screws (11) on rear guide (3).
- (7) Soldier A and Soldier B tighten two screws (6) on rear guide (3).
- (8) Soldier A and Soldier B tighten four locknuts (10) on rear guide (3).
- (9) Remove lifting device from rear guide (3).

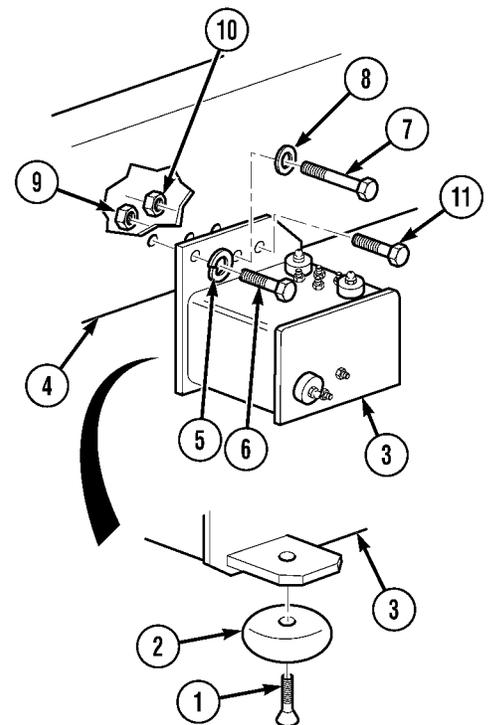

c. Follow-on Maintenance. Remove wheel chocks (TM 9-2320-279-10).

END OF TASK

Organizational Maintenance Instructions (Cont)

4-53.11 CONTAINER HANDLING UNIT (CHU) FRONT LIFT ADAPTER LOWER CONTAINER LOCK PLATE REPAIR.

This task covers:

- | | |
|---------------------|--------------------------|
| a. Removal | c. Installation |
| b. Clean/Inspection | d. Follow-on Maintenance |

INITIAL SETUP

Models

M1120

Personnel Required

MOS 63S, Heavy wheel vehicle mechanic

Test Equipment

None

References

None

Special Tools

Tool Kit, General Mechanic's: Automotive, Item 33, Appendix B
 Compressor Unit, Air Item 2.2, Appendix B
 Gloves, Chemical Oil Protective, Item 11, Appendix B
 Goggles, Industrial, Item 12, Appendix B
 Gun, Air Blow, Item 12.1, Appendix B

Equipment Condition

<i>TM or Para</i>	<i>Condition Description</i>
Para 2-10.11	Front lift adapter removed from truck

Special Environmental Conditions

None

General Safety Instructions

None

Supplies

Sealing Compound, Item 16, Appendix F
 Solvent, Drycleaning, Item 18, Appendix F

Organizational Maintenance Instructions (Cont)

a. Removal.

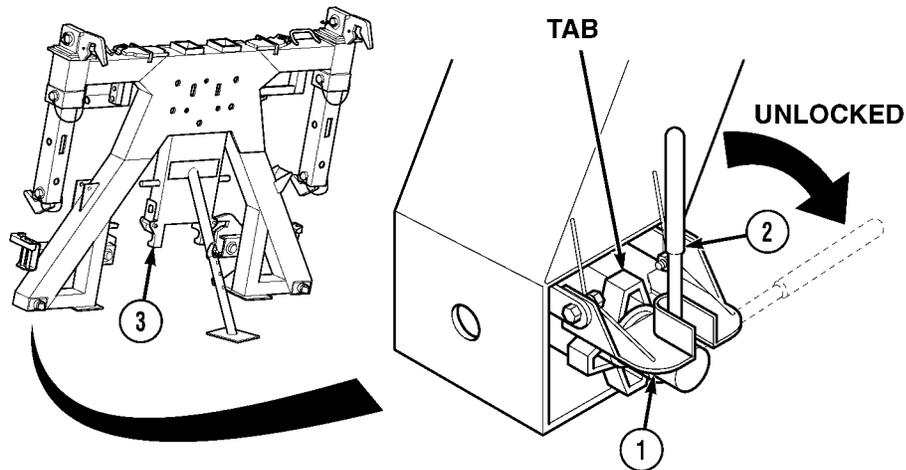

NOTE

There are two lower container lock plates. Both are removed the same way. Right side is shown.

- (1) Raise handle lock plate (1) and rotate lower container lock handle (2) toward center of front lift adapter (3) to unlock.

NOTE

Make sure tab on handnut faces up.

- (2) Release handle lock plate (1) on front lift adapter (3).
- (3) Remove two nuts (4) from screws (5).

NOTE

Note position of springs prior to removal.

- (4) Remove two screws (5) with springs (6) and handle lock plate (1) from front lift adapter (3).
- (5) Remove springs (6) from screws (5).

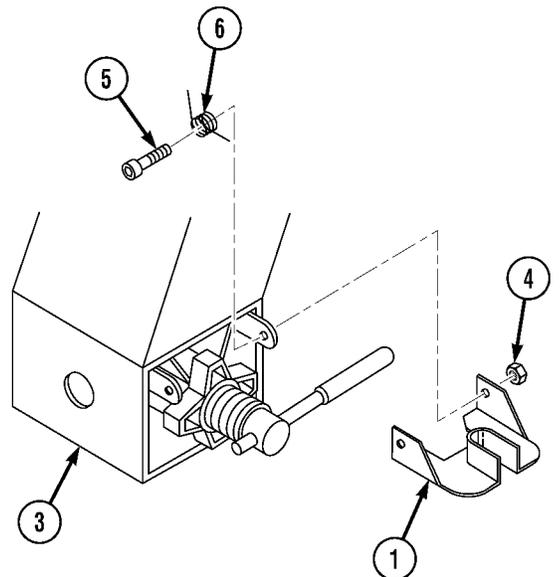

Organizational Maintenance Instructions (Cont)

4-53.11 CONTAINER HANDLING UNIT (CHU) FRONT LIFT ADAPTER LOWER CONTAINER LOCK PLATE REPAIR (CONT).

b. Cleaning/Inspection.

WARNING

- Drycleaning Solvent (P-D-680) is TOXIC and flammable. Wear protective goggles, face shield, and gloves; use only in a well-ventilated area; avoid contact with skin, eyes, and clothes; and do not breathe vapors. Keep away from heat or flame. Never smoke when using solvent. The flashpoint for Type III Drycleaning Solvent is 200°F (93°C). Failure to do so may result in injury or death to personnel.
- If personnel become dizzy while using cleaning solvent, immediately get fresh air and medical help. If solvent contacts skin or clothes, flush with cold water. If solvent contacts eyes, immediately flush eyes with water and get immediate medical attention.

- (1) Clean all metal parts with drycleaning solvent.

WARNING

Compressed air used for cleaning purposes shall not exceed 30 psi (207 kPa). Use only with effective chip guarding and personal protective equipment (goggles/shield, gloves, etc.), or injury to personnel may result.

- (2) Dry parts with compressed air.
- (3) Inspect parts for breaks, cracks, burrs, and sharp edges. Look for unusual signs of wear on lock plate.
- (4) Replace all damaged parts.

c. Installation.

NOTE

- There are two lower container lock plates. Both are installed the same way. Right side is shown.
- Install springs as noted prior to removal

- (1) Position springs (1) on screws (2).

NOTE

It will be necessary to compress springs before installing screws.

- (2) Install handle lock plate (3) on front lift adapter (4) with two screws (2) and springs (1).

WARNING

Adhesives, solvents, and sealing compounds can burn easily, can give off harmful vapors, and are harmful to skin and clothing. To avoid injury or death, keep away from open fire and use in well-ventilated area. If adhesive, solvent, or sealing compound gets on skin or clothing, wash immediately with soap and water.

- (3) Apply sealing compound to threads of two screws (2).
- (4) Install two nuts (6) on screws (2).

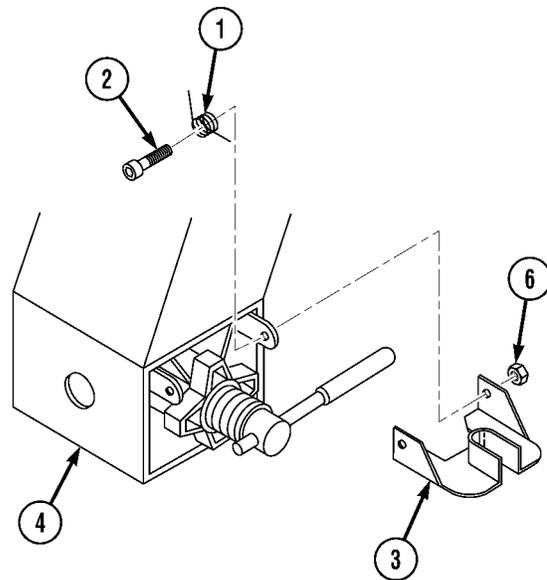

Organizational Maintenance Instructions (Cont)**NOTE**

Make sure tab on handnut faces up.

- (5) Hold handle lock plate (3) up and rotate lower container lock handle (7) up to locked position.
- (6) Release handle lock plate (3) on front lift adapter (4).

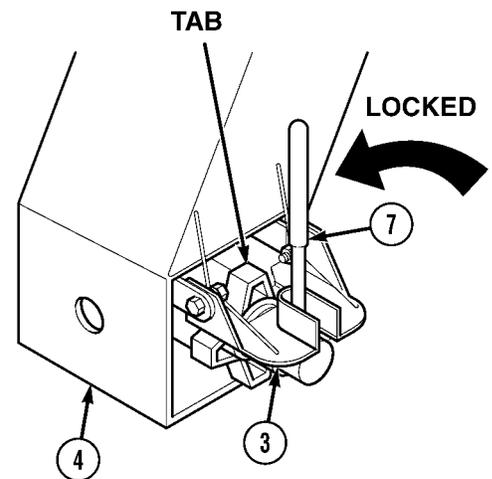
**d. Follow-on Maintenance.**

- (1) Lubricate lock plate (Para 3-2).
- (2) Install front lift adapter on truck (Para 2-10.11).
- (3) Remove wheel chocks (TM 9-2320-279-10).

END OF TASK

Organizational Maintenance Instructions (Cont)

4-53.12 FRONT LIFT ADAPTER LOWER CONTAINER LOCK REPAIR.

This task covers:

a. Removal

b. Installation

c. Follow-on Maintenance

INITIAL SETUP

Models

M1120

References

None

Test Equipment

None

Equipment Condition

TM or Para

Condition Description

Para 4-53.11

Remove front lift adapter lower container lock plate

Special Tools

Tool Kit, General Mechanic's: Automotive, Item 33, Appendix B

Supplies

None

Special Environmental Conditions

None

Personnel Required

MOS 63S, Heavy wheel vehicle mechanic

General Safety Instructions

None

a. Removal.

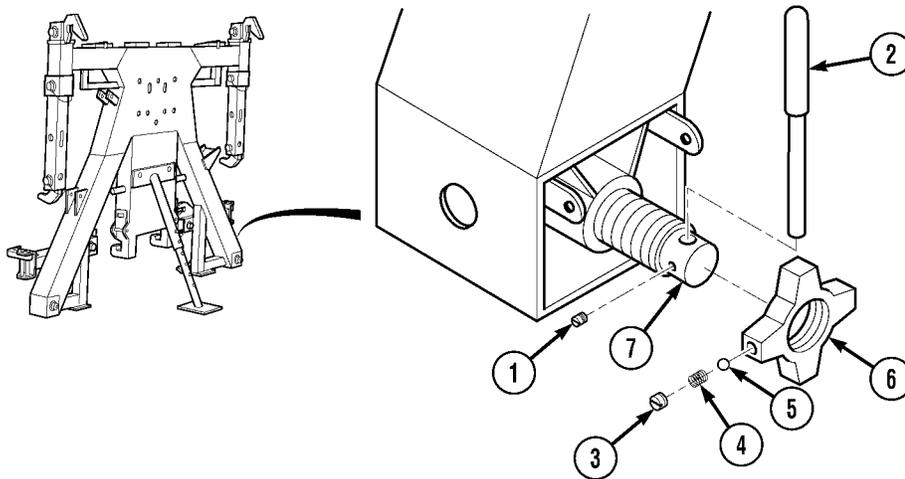

- (1) Remove set screw (1) and handle (2).
- (2) Remove pipe-plug (3), spring (4), and detent ball (5) from handnut (6).
- (3) Remove handnut (6) from FLA container lock shaft (7).

Organizational Maintenance Instructions (Cont)

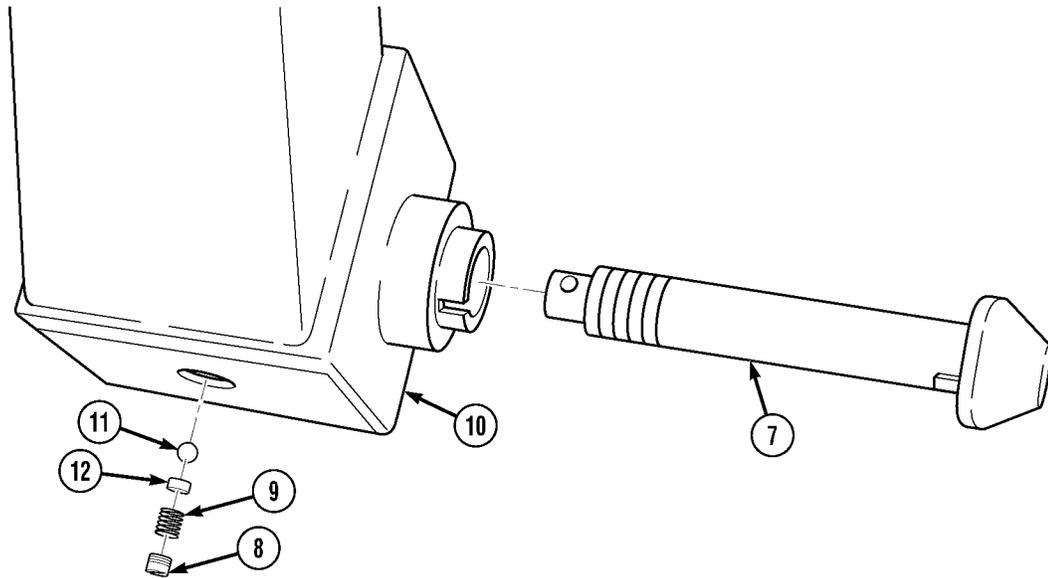

- (4) Remove pipe-plug (8) and spring (9) from FLA lower container lock housing (10).
- (5) Remove lock shaft (7) from lower container lock housing (10).

b. Removal.

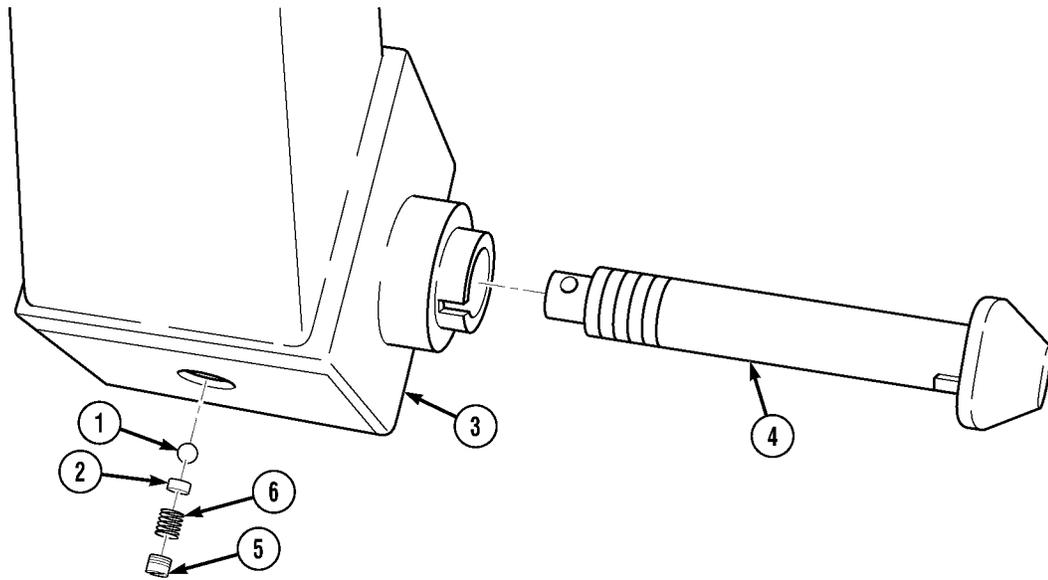

- (1) Install detente (1) and spacer (2) into FLA lower container lock housing (3)
- (2) Install the lock shaft (4) into the lower container lock housing (3).
- (3) Install pipe-plug (5) and spring (6) into the FLA lower container lock housing (3).

Organizational Maintenance Instructions (Cont)

4-53.12 FRONT LIFT ADAPTER LOWER CONTAINER LOCK REPAIR (CONT).

- (4) Install handnut (7) on FLA container lock shaft (4).
- (5) Install pipe-plug (8), spring (9), and detent ball (10) into handnut (7).
- (6) Install set screw (11) and handle (12).

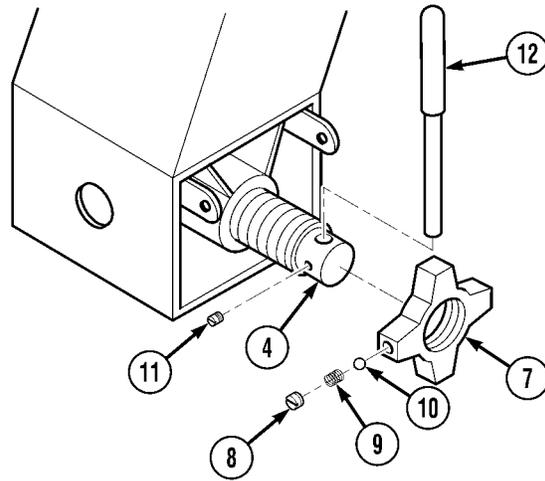

c. Follow-on Maintenance. Install front lift adapter lower container lock plate (Para 4-53.11).

END OF TASK

Organizational Maintenance Instructions (Cont)

4-53.13 CONTAINER HANDLING UNIT (CHU) BUMPER REPLACEMENT.		
This task covers:		
a. Removal	b. Installation	c. Follow-on Maintenance
INITIAL SETUP		
<i>Models</i> M1120	<i>References</i> None	
<i>Test Equipment</i> None	<i>Equipment Condition</i> TM or Para	<i>Condition Description</i> TM 9-2320-279-10 Wheels chocked
<i>Special Tools</i> Tool Kit, General Mechanic's: Automotive, Item 33, Appendix B	<i>Special Environmental Conditions</i> None	
<i>Supplies</i> Sealing Compound, Item 16, Appendix F Locknut (5), Item 5, Appendix K	<i>General Safety Instructions</i> None	
<i>Personnel Required</i> MOS 63S, Heavy wheel vehicle mechanic		

a. Removal.

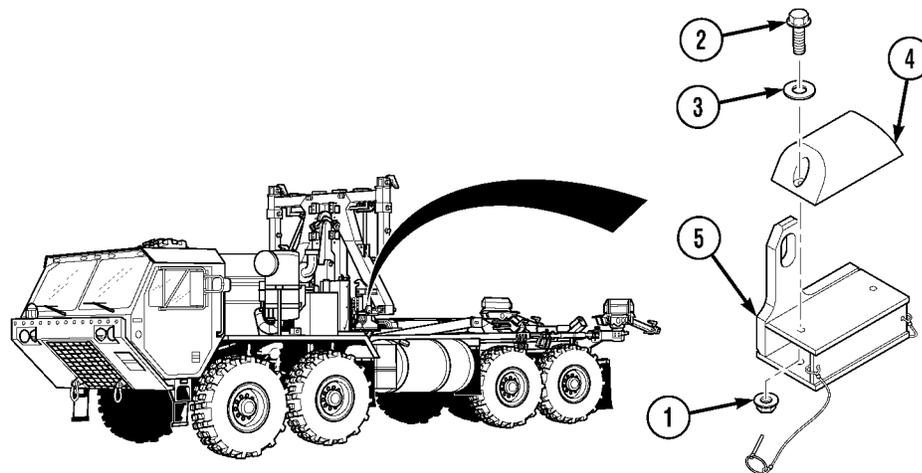

NOTE

Left and right bumpers are identical. Right bumper is shown.

Remove two locknuts (1), screws (2), washers (3), and bumpers (4) from bumper weldment (5). Discard locknuts.

Organizational Maintenance Instructions (Cont)

4-53.13 CONTAINER HANDLING UNIT (CHU) BUMPER REPLACEMENT (CONT).

b. Installation.

WARNING

Adhesives, solvents, and sealing compounds can burn easily, can give off harmful vapors, and are harmful to skin and clothing. To avoid injury or death, keep away from open fire and use in well-ventilated area. If adhesive solvent, or sealing compound gets on skin or clothing, wash immediately with soap and water.

NOTE

Left and right bumpers are identical. Right bumper is shown.

- (1) Apply sealing compound to two screws (1) and locknuts (2).
- (2) Install bumper (3) on bumper weldment (4) with screws (1), washers (5), and locknuts (2).

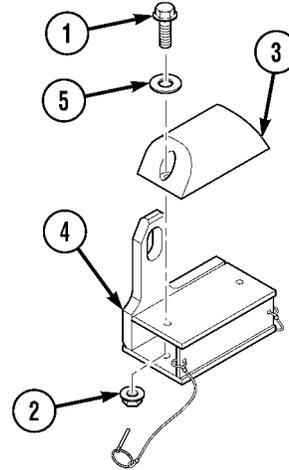

d. Follow-on Maintenance. Remove wheel chocks (TM 9-2320-364-10).

END OF TASK

Organizational Maintenance Instructions (Cont)

4-53.14 CONTAINER HANDLING UNIT (CHU) FRONT CROSSMEMBER ASSEMBLY REPLACEMENT.		
This task covers:		
a. Removal	b. Installation	c. Follow-on Maintenance
INITIAL SETUP		
<i>Models</i> M1120	<i>References</i> None	
<i>Test Equipment</i> None	<i>Equipment Condition</i>	
<i>Special Tools</i> Tool Kit, General Mechanic's: Automotive, Item 33, Appendix B Lifting Device, Minimum Capacity 500 lbs. (227 kg)	<i>TM or Para</i> TM 9-2320-279-10 TM 9-2320-279-10 Para 4-53.13 Para 4-53.7	<i>Condition Description</i> Engine OFF Wheels chocked Bumper weldment removed CHU stowage tray removed
<i>Supplies</i> Locknut (18), Item 2.1, Appendix K	<i>Special Environmental Conditions</i> None	
<i>Personnel Required</i> MOS 63S, Heavy wheel vehicle mechanic (2)	<i>General Safety Instructions</i> None	

Organizational Maintenance Instructions (Cont)

4-53.14 CONTAINER HANDLING UNIT (CHU) FRONT CROSSMEMBER ASSEMBLY REPLACEMENT (CONT).

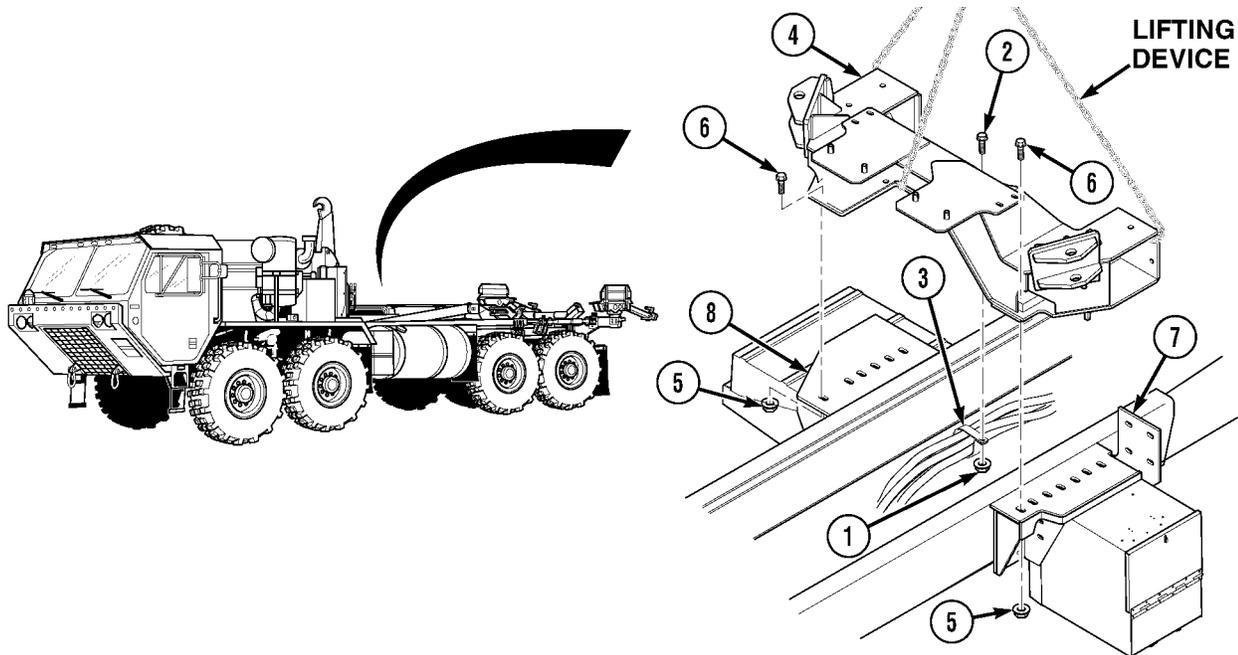
**WARNING**

Front crossmember assembly weighs approximately 500 lbs. (227 kg). Attach suitable lifting device to prevent possible injury to personnel.

a. Removal.

- (1) Remove locknut (1), screw (2), and cushion clamp (3) from front crossmember assembly (4).
- (2) Attach lifting device to front crossmember assembly (1).
- (3) Remove 18 locknuts (5) and screws (6) from front crossmember assembly (4), right front support bracket (7), and left front support bracket (8). Discard locknuts.
- (4) Remove front crossmember assembly (4) from support brackets (7) and (8).
- (5) Position front crossmember assembly (4) on ground and remove lifting device.

b. Installation.

- (1) Attach lifting device to front crossmember assembly (4).
- (2) Soldier A and Soldier B position front crossmember assembly (4) on left front support bracket (8) and right front support bracket (7).
- (3) Install front crossmember assembly (4) to front support brackets (8) and (7) with 18 screws (6) and locknuts (5).
- (4) Remove lifting device from front crossmember assembly (4).
- (5) Install cushion clamp (3), screw (2), and locknut (1) on front crossmember (4).

c. Follow-on Maintenance.

- (1) Install bumper weldment (Para 4-53.13).
- (2) Install CHU stowage tray (Para 4-53.7).
- (3) Remove wheel chocks (TM 9-2320-279-10).

END OF TASK

Organizational Maintenance Instructions (Cont)

4-53.15 CONTAINER HANDLING UNIT (CHU) FRONT SUPPORT BRACKETS REPLACEMENT.		
This task covers:		
a. Removal	b. Installation	c. Follow-on Maintenance
INITIAL SETUP		
<i>Models</i> M1120	<i>References</i> None	
<i>Test Equipment</i> None	<i>Equipment Condition</i>	
<i>Special Tools</i> Tool Kit, General Mechanic's: Automotive, Item 33, Appendix B Lifting Device, Minimum Capacity 100 lbs. (45 kg)	<i>TM or Para</i>	<i>Condition Description</i>
	TM 9-2320-279-10	Engine OFF
	TM 9-2320-279-10	Wheels chocked
	Para 4-53.14	Front crossmember support removed
	TM 9-2320-279-20	Battery box removed
<i>Supplies</i> Locknut (29), Item 2.1, Appendix K Locknut (10), Item 3, Appendix K	<i>Special Environmental Conditions</i> None	
<i>Personnel Required</i> MOS 63S, Heavy wheel vehicle mechanic (2)	<i>General Safety Instructions</i> None	

Organizational Maintenance Instructions (Cont)

4-53.15 CONTAINER HANDLING UNIT (CHU) FRONT SUPPORT BRACKETS REPLACEMENT (CONT).

a. Removal.

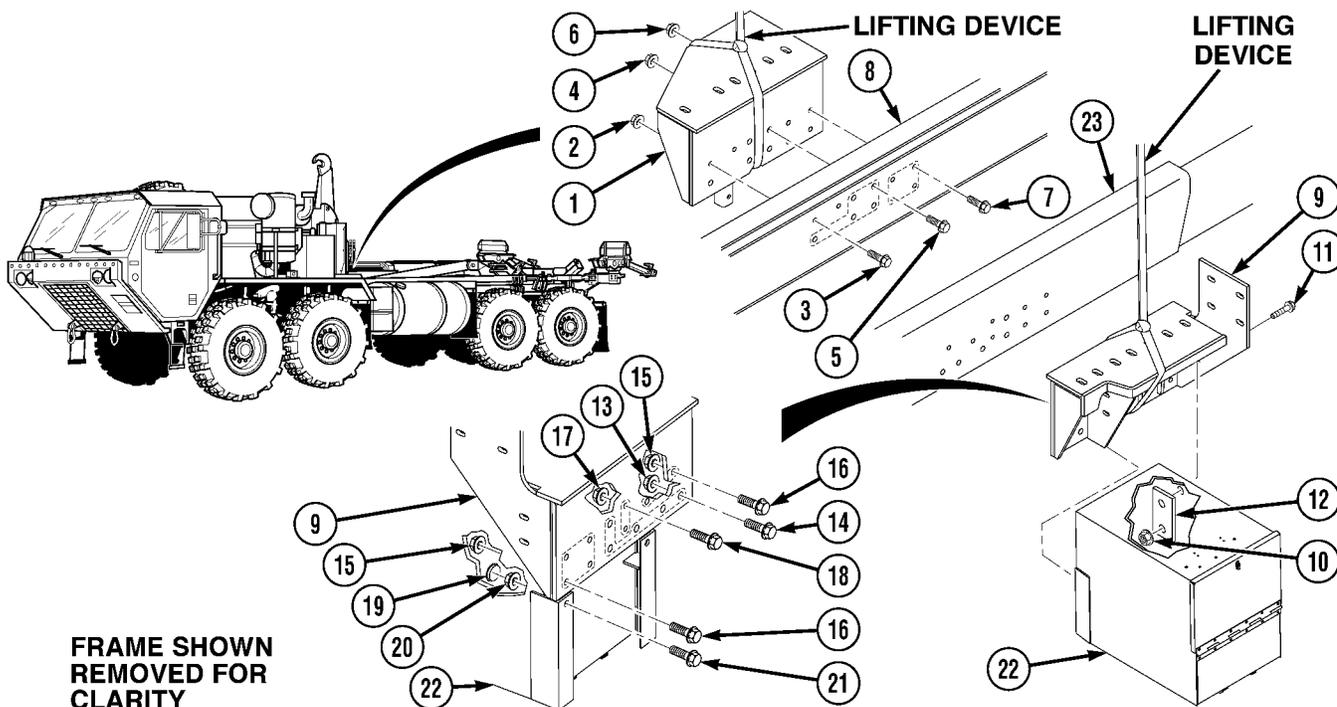

WARNING

Right front support bracket weighs 98 lbs. (44 kg). Attach suitable lifting device to prevent possible injury to personnel.

- (1) Attach lifting device to right front support bracket (1).
- (2) Remove nut (2), screw (3), five nuts (4), five screws (5), four nuts (6), and four screws (7).
- (3) Remove right front support bracket (1) from frame (8).
- (4) Position right front support bracket (1) on ground. Remove lifting device.

WARNING

Left front support bracket weighs 98 lbs. (44 kg). Attach suitable lifting device to prevent possible injury to personnel.

- (5) Attach lifting device to left front support bracket (9).

WARNING

To prevent injury to personnel, properly support stowage box.

- (6) Remove four nuts (10), four screws (11), two plates (12), five nuts (13), five screws (14), six nuts (15), six screws (16), two nuts (17), two screws (18), two plugs (19), two nuts (20), and two screws (21).
- (7) Remove left front support bracket (9) and stowage box (22) from frame (23).
- (8) Position left front support bracket (9) on ground. Remove lifting device.

Organizational Maintenance Instructions (Cont)

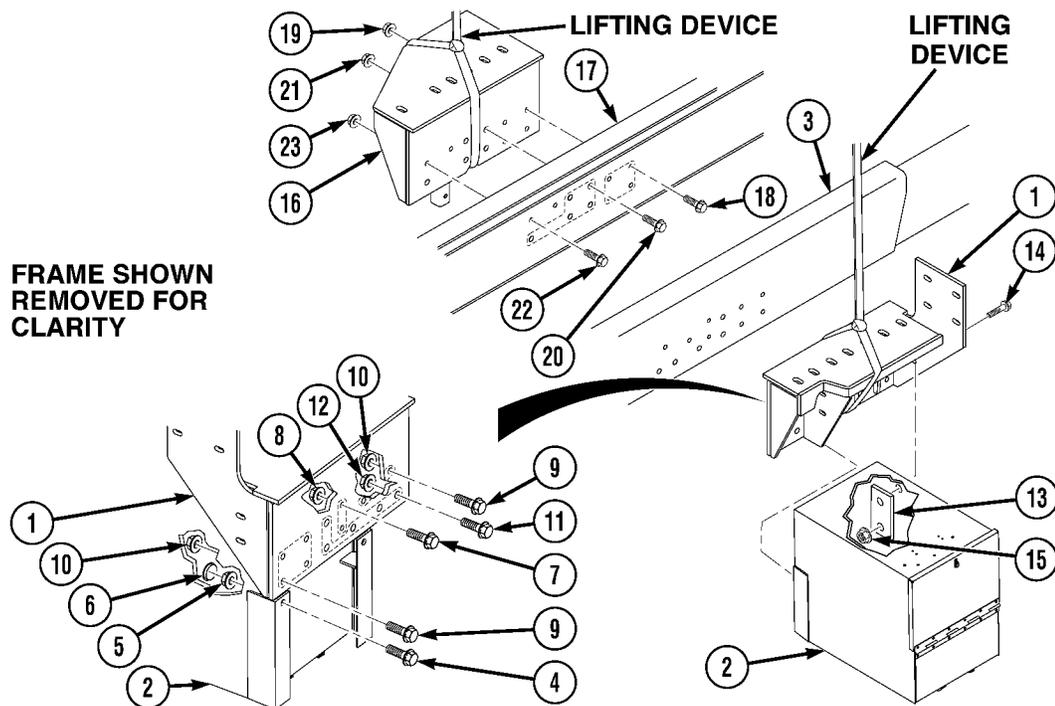

b. Installation.

WARNING

Left front support bracket weighs 98 lbs. (44 kg). Attach suitable lifting device to prevent possible injury to personnel.

- (1) Attach lifting device to left front support bracket (1).
- (2) Position left front support bracket (1) and stowage box (2) on frame (3).

NOTE

Do not tighten any screws until all screws are installed.

- (3) Install two screws (4), two nuts (5), two plugs (6), two screws (7), two nuts (8), six screws (9), six nuts (10), five screws (11), five nuts (12), two plates (13), four screws (14), and four nuts (15). Tighten all screws.
- (4) Remove lifting device from left front support bracket (1).

WARNING

Right front support bracket weighs 98 lbs. (44 kg). Attach suitable lifting device to prevent possible injury to personnel.

- (5) Attach suitable lifting device to right front support bracket (16).
- (6) Position right front support bracket (16) on frame (17).

NOTE

Do not tighten any screws until all screws are installed.

- (7) Install four screws (18), four nuts (19), five screws (20), five nuts (21), screw (22), and nut (23). Tighten all screws.
- (8) Remove lifting device from right front support bracket (16).

Organizational Maintenance Instructions (Cont)

4-53.15 CONTAINER HANDLING UNIT (CHU) FRONT SUPPORT BRACKETS REPLACEMENT (CONT).

c. Follow-on Maintenance.

- (1) Install battery box (TM 9-2320-279-279-20).
- (2) Install front crossmember support bracket (Para 4-53.14).
- (3) Remove wheel chocks (TM 9-2320-279-10).

END OF TASK

4-53.16 CONTAINER HANDLING UNIT (CHU) WEAR PAD REPLACEMENT.

This task covers:

- a. Removal
- b. Installation
- c. Follow-on Maintenance

INITIAL SETUP

Models

M1120

Test Equipment

None

Special Tools

Tool Kit, General Mechanic's: Automotive, Item 33, Appendix B

Supplies

Sealing Compound, Item 14, Appendix F

Personnel Required

MOS 63S, Heavy wheel vehicle mechanic

References

None

Equipment Condition

TM or Para
Para 2-10.11

Condition Description
Front lift adapter
removed from truck

Special Environmental Conditions

None

General Safety Instructions

None

a. Removal.

- (1) Remove four screws (1) and two short wear pads (2) from front lift adapter (3).

b. Installation.

- (1) Apply sealing compound to threads of four screws (1).
- (2) Install two short wear pads (2) to front lift adapter (3) with four screws (1).

c. Follow-on Maintenance. None.

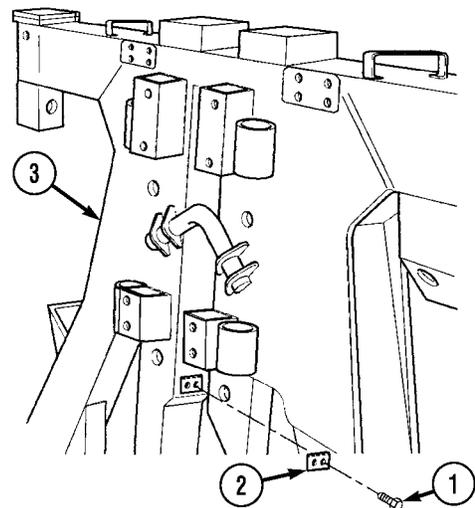

END OF TASK

Organizational Maintenance Instructions (Cont)**4-54. OVERVIEW (LOAD HANDLING SYSTEM).**

Refer to Para 1-13 for an overview of the Load Handling System (LHS) used on the M1120 truck.

4-55. OVERVIEW (HYDRAULIC SYSTEM).

The M1120 truck uses the same hydraulic pump as the M978 HEMTT. Refer to TM 9-2320-279-20 for all hydraulic pump troubleshooting and repair procedures.

4-56. PRINCIPLES OF OPERATION.

Fluid power for the LHS is provided by a hydraulic pump driven by the power takeoff (PTO) mounted on the transmission. The PTO switch, located in the cab, is used to engage and disengage the PTO. Hydraulic fluid is drawn from and returns to the hydraulic reservoir by hydraulic hoses.

4-57. HYDRAULIC FILTER AND HOUSING REPLACEMENT.

Refer to TM 9-2320-279-20 for maintenance procedures for the Hydraulic Filter and Housing.

Organizational Maintenance Instructions (Cont)

4-58. HYDRAULIC HOSE REPLACEMENT.	
This task covers:	
a. Typical Hydraulic Coupling Removal	d. Typical Clip, Clamp, and Bracket Installation
b. Typical Hydraulic Coupling Installation	e. Hydraulic Lines
c. Typical Clip, Clamp, and Bracket Removal	f. Follow-on Maintenance
INITIAL SETUP	
<i>Models</i> M1120	<i>References</i> None
<i>Test Equipment</i> None	<i>Equipment Condition</i> TM or Para <i>Condition Description</i> TM 9-2320-279-10 Engine OFF TM 9-2320-279-20 Hydraulic reservoir drained (only when replacing reservoir lines)
<i>Special Tools</i> None	<i>Special Environmental Conditions</i> None
<i>Supplies</i> Tags, Identification, Item 19, Appendix F Ties, Cable, Item 4, Appendix F	<i>General Safety Instructions</i> None
<i>Personnel Required</i> MOS 63S, Heavy wheel vehicle mechanic	

NOTE

- This procedure only shows location of LHS hydraulic lines. Refer to TM 9-2320-279-20 for vehicle hydraulic lines. It will never be necessary to remove all hydraulic lines at once.
- All hydraulic lines are connected with compression fittings. Some fittings will not have preformed packings. Fitting from which hydraulic line is being removed or installed can be an elbow, tee, or adapter on a valve or other hydraulic component or hydraulic lines. All compression fittings are removed and installed the same way. Elbow fitting is shown.
- Tag and mark position of all hydraulic lines. Cut plastic cable ties as necessary.

a. Typical Hydraulic Coupling Removal. Loosen fitting (1). Remove preformed packing (2) and hose (3) from elbow (4).

b. Typical Hydraulic Coupling Installation. Install preformed packing (2) and connect hose (3) on elbow (4) with fitting (1).

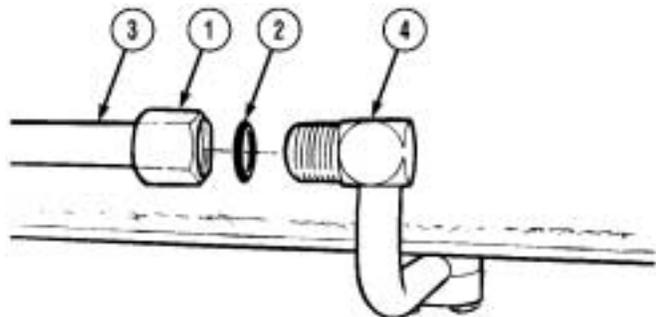

Organizational Maintenance Instructions (Cont)

c. Typical Clip, Clamp, and Bracket Removal.

NOTE

- All clips, clamps, and brackets are removed and installed the same way.
- Mark position of brackets.

- (1) Remove locknut (1), washer (2), and cushion clip (3).
- (2) Remove screw (4), washer (5), plate (6), and two clamps (7).
- (3) Remove nuts (8), screws (9), and bracket (10).

d. Typical Clip, Clamp, and Bracket Installation.

- (1) Install bracket (10), screws (9), and nuts (8).
- (2) Install two clamps (7), plate (6), washer (5), and screw (4).
- (3) Install cushion clip (3), washer (2), and locknut (1).

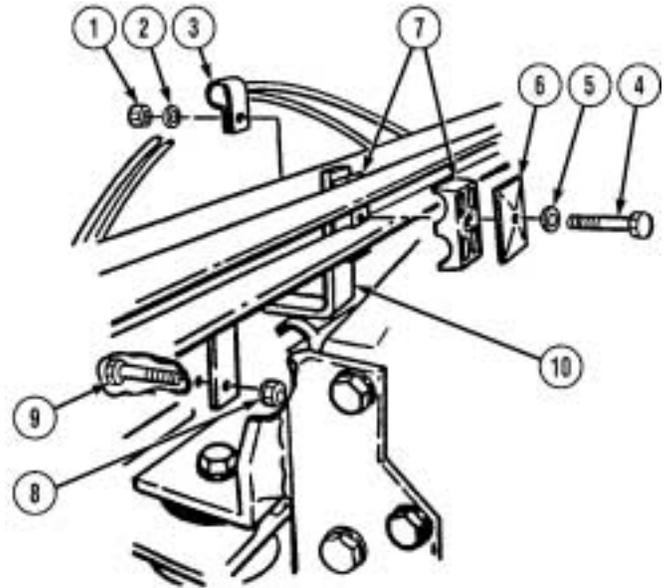

Organizational Maintenance Instructions (Cont)

4-58. HYDRAULIC HOSES REPLACEMENT (CONT).

e. Hydraulic Lines.

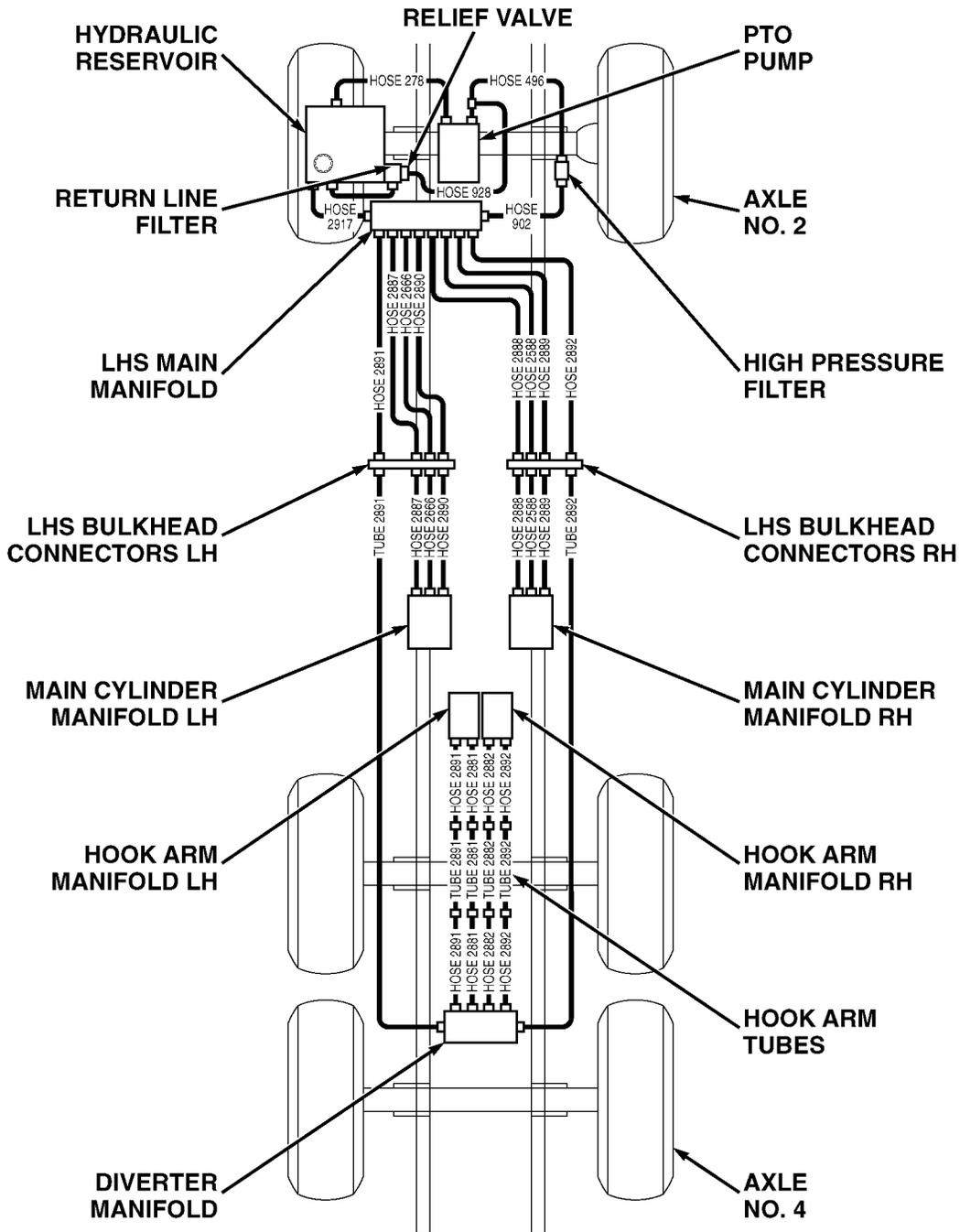

Figure 4-2. Hydraulic Lines - M1120 Vehicle.

f. Follow-on Maintenance. Refill hydraulic reservoir (TM 9-2320-279-20).

END OF TASK

CHAPTER 5

DIRECT SUPPORT AND GENERAL SUPPORT MAINTENANCE

Contents	Para	Page
Common Tools and Equipment	5-1	5-2
Special Tools, TMDE, and Support Equipment	5-2	5-2
Repair Parts	5-3	5-2
Inspection Upon Receipt	5-4	5-2
Load Handling System (LHS) Troubleshooting	5-5	5-2
Introduction to Troubleshooting	5-6	5-3
Direct/General Support Troubleshooting Procedures	5-7	5-4
Load Handling System (LHS) Maintenance Introduction	5-8	5-74
General Removal Instructions	5-9	5-74
General Disassembly Instructions	5-10	5-74
General Cleaning Instructions	5-11	5-75
General Inspection Instructions	5-12	5-77
General Repair Instructions	5-13	5-77
General Assembly Instructions	5-14	5-78
General Installation Instructions	5-15	5-79
Preparation for Storage or Shipment Introduction	5-16	5-81
Preparation for Storage or Shipment	5-17	5-81
Storage Maintenance Procedures	5-18	5-81
Load Handling System (LHS) Main Wire Harness Replacement	5-19	5-82
Reverse Alarm Wiring Harness Replacement	5-20	5-92
Load Handling System (LHS) Rubber Bumper Replacement	5-21	5-97
Load Handling System (LHS) Hook Replacement	5-22	5-99
Load Handling System (LHS) Hook Arm Repair	5-23	5-102
Load Handling System (LHS) Main Frame Repair	5-24	5-108
Load Handling System (LHS) Main Frame Tube Replacement	5-25	5-117
Load Handling System (LHS) Compression Frame Repair	5-26	5-127
Load Handling System (LHS) Mounting Bracket Replacement	5-27	5-137
Load Handling System (LHS) Rear Roller Assembly Mounting Bracket Replacement	5-27.1	5-140.1
Load Handling System (LHS) Main Frame Nose Support Replacement	5-28	5-141
Container Handling Unit (CHU) Slider Arm Assembly Repair	5-28.1	5-142.1
Overview (Hydraulic System)	5-29	5-142.6
Load Handling System (LHS) Main Hydraulic Pressure Adjustment	5-30	5-143
Load Handling System (LHS) Main Manifold/Bracket Replacement	5-31	5-149
Load Handling System (LHS) Transit Valve Replacement	5-32	5-166
Load Handling System (LHS) Main Manifold Relief Valve Replacement	5-33	5-169
Load Handling System (LHS) Main Manifold Solenoid Valve and Coil Repair	5-34	5-174
Load Handling System (LHS) Directional Control Valve Replacement	5-35	5-178
Load Handling System (LHS) Hook Arm Manifold Repair	5-36	5-181
Load Handling System (LHS) Hook Arm Cylinder Replacement	5-37	5-189
Load Handling System (LHS) Hook Arm/Main Frame Cylinder Repair	5-38	5-197
Load Handling System (LHS) Main Frame Cylinder Manifold Repair	5-39	5-204
Load Handling System (LHS) Main Frame Cylinder Replacement	5-40	5-212
Load Handling System (LHS) Load Control Valve Main Frame Replacement	5-41	5-218
Load Handling System (LHS) Check Valve Replacement	5-42	5-222
Container Handling Unit (CHU) Kit Installation	5-43	5-225

Direct Support and General Support Maintenance (Cont)

Section I. Repair Parts, Special Tools, TMDE, and Support Equipment

5-1. COMMON TOOLS AND EQUIPMENT.

5-2. SPECIAL TOOLS, TMDE, AND SUPPORT EQUIPMENT.

The Maintenance Allocation Chart (MAC) identifies the authority and responsibility for maintenance tasks listed in this manual. Tool kits, test equipment, and diagnostic equipment required for performing DS & GS Maintenance tasks are identified in the MAC. The Repair Parts and Special Tools List (RPSTL) lists special tools, TMDE, and support equipment required to perform support maintenance procedures contained in this manual. Tools that are to be fabricated are listed in Appendix H.

5-3. REPAIR PARTS.

Repair parts are listed and illustrated in the Repair Parts and Special Tools List (Appendix C) covering Direct Support and General Support Maintenance for this vehicle.

Section II. Service Upon Receipt

5-4. INSPECTION UPON RECEIPT.

Refer to TM 9-2320-279-20 for inspection upon receipt instructions.

Section III. Troubleshooting

5-5. LOAD HANDLING SYSTEM (LHS) TROUBLESHOOTING.

This paragraph covers, Load Handling System (LHS) Troubleshooting. The LHS Fault Index, Table 5-1 lists faults for the LHS of the M1120 truck.

Direct Support and General Support Maintenance (Cont)

5-6. INTRODUCTION TO TROUBLESHOOTING.**a. How to Begin Troubleshooting.**

- (1) Determine the symptom or condition that indicates a problem or failure. Troubleshooting is divided into symptoms peculiar to the LHS or component: for example, hook arm or main frame. Refer to the Load Handling System Fault Index (Table 5-1).
- (2) Go to the referenced page to begin troubleshooting.
- (3) Follow the Diagnostic Procedure.
- (4) Observe warnings, cautions, and notes. The formatting and symbols used in this manual for warnings, cautions, and notes are as follows:

WARNING

This is the symbol for a warning statement. WARNINGS describe a situation which could cause severe injury or death to personnel.

CAUTION

This is the symbol for a caution statement. CAUTIONS describe a situation which could cause damage to equipment.

NOTE

This is the symbol for a note. Notes are located directly above the test to which they refer. Notes provide additional information for performing a test.

b. Abbreviations and Commonly Used Terms.

- (1) CKT - Circuit.
- (2) COM - Common.
- (3) Diagnostics - Troubleshooting by following an exact procedure.
- (4) Erratic - Intermittent.
- (5) System - A collection of devices which all are related to each other because they depend on each other to do some function or job. For example, the function of the fuel system is to inject fuel into the cylinders at the correct time in the correct amount and with the correct quantity. The collection of devices that are required to do this include the fuel pump, fuel lines, lift pump, fuel filter, and injectors.
- (6) Test Chain - A series of tests to be followed in a particular order or sequence (numbered).
- (7) Troubleshooting - The process of making measurements and observing the operation of the truck to find out if and where any problems exist.

Direct Support and General Support Maintenance (Cont)

5-7. DIRECT/GENERAL SUPPORT TROUBLESHOOTING PROCEDURES.

Table 5-1. Load Handling System Fault Index

Fault No.	Description	Page
1.	Loss of Hook Arm Safe Lowering	5-5
2.	Loss of Main Frame Safe Lowering	5-10
3.	Hook Arm Does Not Load	5-13
4.	Hook Arm Does Not Unload	5-21
5.	Loss of Hook Arm Load Holding	5-29
6.	Main Frame Does Not Load	5-38
7.	Main Frame Does Not Unload	5-46
8.	Main Frame Does Not Operate	5-54
9.	LHS Does Not Operate or Operates Slowly	5-60
10.	Loss of Main Frame Load Holding	5-62
11.	LHS Hook Arm Disengages from Flatrack While Unloading	5-71

Direct Support and General Support Maintenance (Cont)

Table 5-2. Direct Support/General Support Troubleshooting

Malfunction	Test or Inspection	Corrective Action
LOAD HANDLING SYSTEM (LHS)		
1. LOSS OF HOOK ARM SAFE LOWERING.		
<p>The diagram shows a side view of a truck with a Load Handling System (LHS) mounted on the rear. A hook arm is extended upwards and holds a 500-pound load. Labels with arrows point to the 'HOOK ARM SAFE LOWERING BUTTON' on the operator's control panel, the 'HOOK ARM' itself, the 'LHS HOOK' at the end of the arm, and the '500 POUND LOAD' being held. A curved arrow indicates the direction of the load's movement.</p>		
<u>WARNING</u>		
<p>All personnel must stand clear during lifting operations. A swinging or shifting load may cause injury or death to personnel.</p>		
<p>Step 1. Check for operation of safe lowering of a loaded hook arm in the direction of unloading.</p>		
<p>If hook arm does not safe lower, lower load using normal controls and go to Step 6. of this Fault.</p>		
<p>If hook arm does safe lower, go to Step 3. of this Fault.</p>		

Direct Support and General Support Maintenance (Cont)

5-7. DIRECT/GENERAL SUPPORT TROUBLESHOOTING PROCEDURES (CONT).

Table 5-2. Direct Support/General Support Troubleshooting (CONT)

Malfunction	Test or Inspection	Corrective Action
LOAD HANDLING SYSTEM (LHS)		
1. LOSS OF HOOK ARM SAFE LOWERING (CONT).		
<u>WARNING</u>		
Do not get under LHS when disconnecting or connecting connectors and hoses. A hydraulic malfunction could cause LHS to lower causing serious injury or death.		
<u>CAUTION</u>		
Do not scratch surface of cylinder rod. Damage to cylinder seals could result causing cylinder failure.		
<u>NOTE</u>		
Both hook arm safe lowering solenoid valves are tested the same way. Both hook arm manifold safe lowering solenoid valves must be tested. Right side is shown.		
Step 2.	Remove safe lowering solenoid valve from port VA on RH hook arm manifold. Push poppet into valve toward solenoid coil.	
If poppet does not move, replace safe lowering solenoid valve (Para 5-36).		
Step 3.	With engine switch ON, push hook arm safe lowering button, and check for proper electrical operation of the safe lowering solenoid valve in port VA on RH hook arm manifold.	
If poppet does not move, replace safe lowering solenoid valve (Para 5-36).		

Direct Support and General Support Maintenance (Cont)

Table 5-2. Direct Support/General Support Troubleshooting (CONT)

Malfunction	Test or Inspection	Corrective Action
LOAD HANDLING SYSTEM (LHS)		
1. LOSS OF HOOK ARM SAFE LOWERING (CONT).		
<p>The diagram illustrates the truck's Load Handling System (LHS). On the left, a control panel features a 'HOOK ARM SAFE LOWERING BUTTON'. A curved arrow points from this button to the 'LHS HOOK' assembly on the right. The hook assembly includes a 'STEEL TUBE' and is supported by a 'JACK STAND'.</p>		
<u>WARNING</u>		
All personnel must stand clear during lifting operations. A swinging or shifting load may cause injury or death to personnel.		
<u>NOTE</u>		
Lift truck only enough to lift truck's weight off suspension. Do not lift tires off the ground.		
Step 4. Check for operation of safe lowering in the direction of loading.		
If truck does not settle on its suspension, fault not corrected. Notify supervisor.		

Direct Support and General Support Maintenance (Cont)

5-7. DIRECT/GENERAL SUPPORT TROUBLESHOOTING PROCEDURES (CONT).

Table 5-2. Direct Support/General Support Troubleshooting (CONT)

Malfunction	Test or Inspection	Corrective Action
LOAD HANDLING SYSTEM (LHS)		
1. LOSS OF HOOK ARM SAFE LOWERING (CONT).		
<p>The diagram illustrates the components involved in the hook arm safe lowering system. On the left, a hook arm is shown with a safe lowering button and wooden blocks supporting it. On the right, a hook arm manifold is shown with a safe lowering solenoid valve, a port VB, and a connector. A poppet is shown inserted into the manifold, and a preformed packing is shown inserted into the poppet.</p>		
<u>WARNING</u>		
Do not get under LHS when disconnecting or connecting connectors and hoses. A hydraulic malfunction could cause LHS to lower causing serious injury or death.		
<u>NOTE</u>		
Both hook arm manifold safe lowering solenoid valves are tested the same way. Both hook arm manifold safe lowering solenoid valves must be tested. Right side is shown.		
Step 5.	Remove safe lowering solenoid valve from port VB on RH hook arm manifold. Push poppet into valve toward solenoid coil.	
	If poppet does not move, replace safe lowering solenoid valve (Para 5-36).	
Step 6.	With engine switch ON, push hook arm safe lowering button, and check for proper electrical operation of the safe lowering solenoid valve in port VB on RH hook arm manifold.	
	If poppet does not move, replace safe lowering solenoid valve (Para 5-36) and go to Step 7. of this Fault.	

Direct Support and General Support Maintenance (Cont)

Table 5-2. Direct Support/General Support Troubleshooting (CONT)

Malfunction	Test or Inspection	Corrective Action
LOAD HANDLING SYSTEM (LHS)		
1. LOSS OF HOOK ARM SAFE LOWERING (CONT).		
<p>HOOK ARM SAFE LOWERING BUTTON</p>		
<u>WARNING</u>		
<p>All personnel must stand clear during lifting operations. A swinging or shifting load may cause injury or death to personnel.</p>		
<p>Step 7. Check operation of hook arm safe lower in direction of unloading.</p>		
<p style="padding-left: 40px;">If hook arm does not safe lower, fault not corrected. Notify supervisor.</p>		

Direct Support and General Support Maintenance (Cont)

5-7. DIRECT/GENERAL SUPPORT TROUBLESHOOTING PROCEDURES (CONT).

Table 5-2. Direct Support/General Support Troubleshooting (CONT)

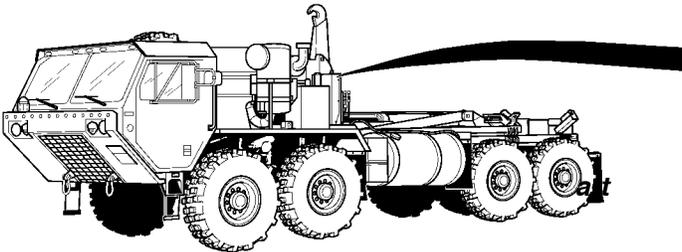
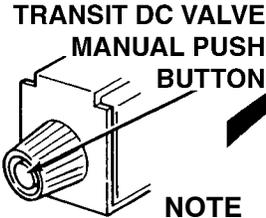
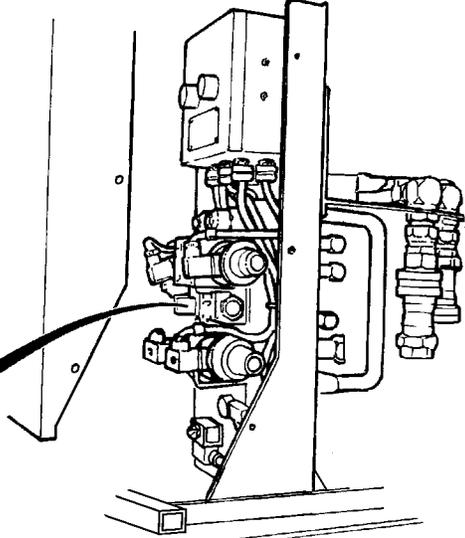
Malfunction	Test or Inspection	Corrective Action
LOAD HANDLING SYSTEM (LHS)		
2. LOSS OF MAIN FRAME SAFE LOWERING.		
	 <p data-bbox="558 995 824 1087">TRANSIT DC VALVE MANUAL PUSH BUTTON</p> <p data-bbox="721 1188 799 1213">NOTE</p>	
<ul style="list-style-type: none"> • Ensure manual push button is pushed past free play to engage. • Only remove center screw on engine side of LHS main junction box cover. 		
<p>Step 1. Check operation of transit directional control (DC) valve manual push button.</p>	<p>If button cannot be pushed in, transit DC valve is faulty. Replace transit DC valve (Para 5-34).</p>	

Direct Support and General Support Maintenance (Cont)

Table 5-2. Direct Support/General Support Troubleshooting (CONT)

Malfunction	Test or Inspection	Corrective Action
LOAD HANDLING SYSTEM (LHS)		
2. LOSS OF MAIN FRAME SAFE LOWERING (CONT).		
<p>Step 2. Remove LHS main manifold (Para 5-31) and check for contaminants clogging orifice. If orifice is plugged or damaged clean or replace (Para 5-31).</p>		

Direct Support and General Support Maintenance (Cont)

5-7. DIRECT/GENERAL SUPPORT TROUBLESHOOTING PROCEDURES (CONT).

Table 5-2. Direct Support/General Support Troubleshooting (CONT)

Malfunction	Test or Inspection	Corrective Action
LOAD HANDLING SYSTEM (LHS)		
2. LOSS OF MAIN FRAME SAFE LOWERING (CONT).		
<p>The diagram illustrates the truck's Load Handling System (LHS) and its connection to the main frame. On the left, a vertical panel features the 'MAIN FRAME SAFE LOWERING BUTTON'. A thick black cable runs from this button to the 'LHS HOOK' on the truck's crane. The truck is shown from a side-rear perspective, with a 'STEEL TUBE' and a 'JACK STAND' also labeled. The jack stand is positioned under the truck's rear suspension.</p>		
<u>WARNING</u>		
<p>All personnel must stand clear during lifting operations. A swinging or shifting load may cause injury or death to personnel.</p>		
<p>Step 3. Check for proper safe lower operation of main frame.</p>		
<p style="padding-left: 40px;">If truck does not settle on its suspension, fault not corrected. Notify supervisor.</p>		

Direct Support and General Support Maintenance (Cont)

Table 5-2. Direct Support/General Support Troubleshooting (CONT)

Malfunction	Test or Inspection	Corrective Action
LOAD HANDLING SYSTEM (LHS)		
3. HOOK ARM DOES NOT LOAD.		
NOTE		
<p>For Fault 3 the engine must be running, PTO engaged, and hydraulic selector switch in MAN H.A. position.</p>		
<p>The diagram consists of two parts. On the left is a side view of a truck with a hook arm extended upwards. An arrow points from the text 'HOOK ARM' to the hook arm. On the right is a detailed view of the hydraulic control panel. Two arrows point from labels to specific components: 'DC VALVE HOOK ARM LOAD' points to a valve on the panel, and 'FREE FLOW VALVE MANUAL PUSH BUTTON' points to a button below it.</p>		
NOTE		
<p>Ensure manual push button is pushed past free play to engage.</p>		
Step 1.	<p>Operate hook arm loading function using DC valve manual push button and free flow valve manual push button.</p>	
	<p>If hook arm loads, replace lower DC valve (Para 5-35).</p>	

Direct Support and General Support Maintenance (Cont)

5-7. DIRECT/GENERAL SUPPORT TROUBLESHOOTING PROCEDURES (CONT).

Table 5-2. Direct Support/General Support Troubleshooting (CONT)

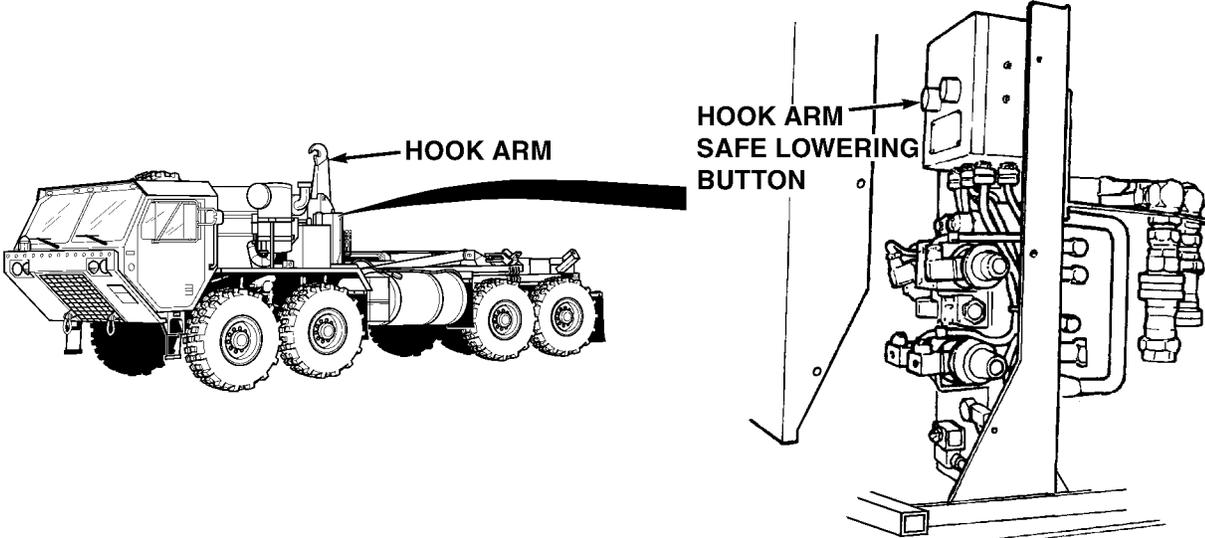
Malfunction	Test or Inspection	Corrective Action
LOAD HANDLING SYSTEM (LHS)		
3. HOOK ARM DOES NOT LOAD (CONT).		
 The diagram shows a side view of a truck with a hook arm. An arrow points from the hook arm to a detailed view of the hook arm safe lowering button. The button is a rectangular panel with a joystick and a push-button. Labels 'HOOK ARM' and 'HOOK ARM SAFE LOWERING BUTTON' are present.		
<p>Step 2. Use joystick to operate hook arm loading function with hook arm safe lowering button pushed in.</p> <p style="padding-left: 40px;">If hook arm does not load, go to Step 6. of this Fault.</p>		

Direct Support and General Support Maintenance (Cont)

Table 5-2. Direct Support/General Support Troubleshooting (CONT)

Malfunction	Test or Inspection	Corrective Action
LOAD HANDLING SYSTEM (LHS)		
3. HOOK ARM DOES NOT LOAD (CONT).		
<p>The diagram illustrates the hydraulic manifold assembly for the hook arm. On the left, a manifold block is shown with a 'SAFE LOWERING SOLENOID VALVE' on the left side, a 'CONNECTOR' at the bottom left, and 'PORT VA' on the right side. A 'HOOK ARM MANIFOLD' is also labeled. On the right, a vertical panel on the vehicle's LHS features a 'HOOK ARM SAFE LOWERING BUTTON'. A truck is shown at the bottom left with the 'HOOK ARM' extended. Arrows indicate the hydraulic lines connecting the manifold to the button and the solenoid valve.</p>		
<u>WARNING</u>		
<p>Do not get under LHS when disconnecting or connecting connectors and hoses. A hydraulic malfunction could cause LHS to lower causing serious injury or death.</p>		
Step 3.	<p>Use joystick to operate hook arm load function with harness connectors disconnected from safe lowering solenoid valves on port VA side of LH and RH hook arm manifolds and hook arm safe lowering button pushed in.</p>	
<p>If hook arm does not load, go to Step 5. of this Fault.</p>		

Direct Support and General Support Maintenance (Cont)

5-7. DIRECT/GENERAL SUPPORT TROUBLESHOOTING PROCEDURES (CONT).

Table 5-2. Direct Support/General Support Troubleshooting (CONT)

Malfunction	Test or Inspection	Corrective Action
LOAD HANDLING SYSTEM (LHS)		
3. HOOK ARM DOES NOT LOAD (CONT).		
<p>The diagram illustrates the hydraulic system for the hook arm. On the left, a truck is shown with its hook arm extended. A thick black arrow points from the hook arm to a detailed view of the hook arm manifold and safe lowering solenoid valve assembly. Labels include: HOOK ARM MANIFOLD, SAFE LOWERING SOLENOID VALVE, PORT VB, CONNECTOR, and HOOK ARM SAFE LOWERING BUTTON. The manifold has two ports on the left and a solenoid valve on the right. A connector is shown between the solenoid valve and the hook arm safe lowering button.</p>		
<u>WARNING</u>		
<p>Do not get under LHS when disconnecting or connecting connectors and hoses. A hydraulic malfunction could cause LHS to lower causing serious injury or death.</p>		
Step 4.	<p>Use joystick to operate hook arm load function with harness connector disconnected from safe lowering solenoid valve on port VB side of RH hook arm manifold and hook arm safe lowering button pushed in.</p>	
	<p>If hook arm does not load, repair RH hook arm manifold at port VB (Para 5-36).</p>	
	<p>If hook arm loads, repair LH hook arm manifold at port VB (Para 5-36).</p>	

Direct Support and General Support Maintenance (Cont)

Table 5-2. Direct Support/General Support Troubleshooting (CONT)

Malfunction	Test or Inspection	Corrective Action
LOAD HANDLING SYSTEM (LHS)		
3. HOOK ARM DOES NOT LOAD (CONT).		
WARNING		
<p>Do not get under LHS when disconnecting or connecting connectors and hoses. A hydraulic malfunction could cause LHS to lower causing serious injury or death.</p>		
Step 5.	<p>Use joystick to operate hook arm load function with harness connector disconnected from safe lowering solenoid valve on port VA side of RH hook arm manifold and hook arm safe lowering button pushed in.</p>	
	<p>If hook arm does not load, repair RH hook arm manifold at port VA (Para 5-36).</p>	
	<p>If hook arm loads, repair LH hook arm manifold at port VA (Para 5-36).</p>	

Direct Support and General Support Maintenance (Cont)

5-7. DIRECT/GENERAL SUPPORT TROUBLESHOOTING PROCEDURES (CONT).

Table 5-2. Direct Support/General Support Troubleshooting (CONT)

Malfunction	Test or Inspection	Corrective Action
LOAD HANDLING SYSTEM (LHS)		
3. HOOK ARM DOES NOT LOAD (CONT).		
WARNING		
<ul style="list-style-type: none"> • The LHS hydraulic system operates at oil pressures up to 1,725 psi (11 894 kPa). Never disconnect any hydraulic line or fitting without first dropping pressure to zero. Failure to comply may result in serious injury or death to personnel. • Fuel and oil are slippery and can cause falls. To avoid injury, wipe up spilled fuel or oil with rags. • Do not get under LHS when disconnecting or connecting connectors and hoses. A hydraulic malfunction could cause LHS to lower causing serious injury or death. 		
NOTE		
<p>Hose 2917 is disconnected while installing and removing flowmeter. Hose 2917 must be connected during test.</p>		
<p>Step 6. Check hydraulic flow at LH hook arm manifold, port VA with LHS in transit position while holding joystick in LOAD position.</p>		
<p style="padding-left: 40px;">If more than 0 gpm (0 lpm) is present, replace LH hook arm cylinder (Para 5-37).</p>		

Direct Support and General Support Maintenance (Cont)

Table 5-2. Direct Support/General Support Troubleshooting (CONT)

Malfunction	Test or Inspection	Corrective Action
LOAD HANDLING SYSTEM (LHS)		
3. HOOK ARM DOES NOT LOAD (CONT).		
<u>WARNING</u>		
<ul style="list-style-type: none"> • The LHS hydraulic system operates at oil pressures up to 1,725 psi (11 894 kPa). Never disconnect any hydraulic line or fitting without first dropping pressure to zero. Failure to comply may result in serious injury or death to personnel. • Fuel and oil are slippery and can cause falls. To avoid injury, wipe up spilled fuel or oil with rags. • Do not get under LHS when disconnecting or connecting connectors and hoses. A hydraulic malfunction could cause LHS to lower causing serious injury or death. 		
<u>NOTE</u>		
<p>Hose 2917 is disconnected while installing and removing flowmeter. Hose 2917 must be connected during test.</p>		
Step 7.	<p>Check hydraulic flow at RH hook arm manifold, port VA with LHS in transit position while holding joystick in LOAD position.</p>	
<p>If more than 0 gpm (0 lpm) is present, replace RH hook arm cylinder (Para 5-37).</p>		

Direct Support and General Support Maintenance (Cont)

5-7. DIRECT/GENERAL SUPPORT TROUBLESHOOTING PROCEDURES (CONT).

Table 5-2. Direct Support/General Support Troubleshooting (CONT)

Malfunction	Test or Inspection	Corrective Action
LOAD HANDLING SYSTEM (LHS)		
3. HOOK ARM DOES NOT LOAD (CONT).		
<p>Step 8. Check for proper hook arm loading.</p> <p style="padding-left: 40px;">If hook arm does not load, fault not corrected. Notify supervisor.</p>		

Direct Support and General Support Maintenance (Cont)

Table 5-2. Direct Support/General Support Troubleshooting (CONT)

Malfunction	Test or Inspection	Corrective Action
LOAD HANDLING SYSTEM (LHS)		
4. HOOK ARM DOES NOT UNLOAD.		
NOTE		
<p>For Fault 4 the engine must be running, PTO engaged, and hydraulic selector switch in MAN H.A. position.</p>		
<p>The diagram consists of three parts. At the top left is a side view of a truck with a hook arm extending from its rear. An arrow points to the hook arm with the label 'HOOK ARM'. Below this is a close-up view of the hook arm's hydraulic cylinder and valve assembly. At the bottom right is a view of the hydraulic control panel, showing two manual push buttons. One button is labeled 'HOOK ARM UNLOAD MANUAL PUSH BUTTON' and the other is labeled 'FREE FLOW VALVE MANUAL PUSH BUTTON'. Arrows connect these labels to their respective components in the diagrams.</p>		
NOTE		
<p>Ensure manual push button is pushed past free play to engage.</p>		
Step 1.	<p>Check operation of hook arm unload using DC valve manual push button and free flow valve manual push button.</p>	<p>If hook arm unloads, replace lower DC valve (Para 5-35).</p>

Direct Support and General Support Maintenance (Cont)

5-7. DIRECT/GENERAL SUPPORT TROUBLESHOOTING PROCEDURES (CONT).

Table 5-2. Direct Support/General Support Troubleshooting (CONT)

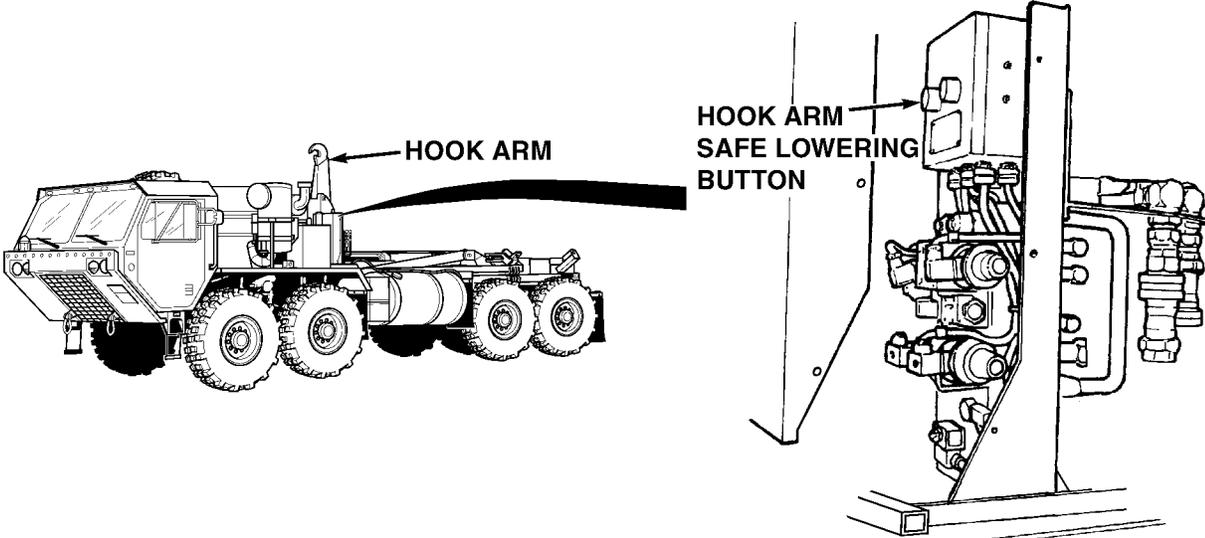
Malfunction	Test or Inspection	Corrective Action
LOAD HANDLING SYSTEM (LHS)		
4. HOOK ARM DOES NOT UNLOAD (CONT).		
		
<p>Step 2. Use joystick to operate hook arm unload with hook arm safe lowering button pushed in. If hook arm does not unload, go to Step 6. of this Fault.</p>		

Direct Support and General Support Maintenance (Cont)

Table 5-2. Direct Support/General Support Troubleshooting (CONT)

Malfunction	Test or Inspection	Corrective Action
LOAD HANDLING SYSTEM (LHS)		
4. HOOK ARM DOES NOT UNLOAD (CONT).		
<u>WARNING</u>		
<p>Do not get under LHS when disconnecting or connecting connectors or hoses. A hydraulic malfunction could cause LHS to lower causing serious injury or death.</p>		
Step 3.	<p>Use joystick to operate hook arm unload function with harness connectors disconnected from safe lowering solenoid valves at port VA side of LH or RH hook arm manifolds and hook arm safe lowering button pushed in.</p>	
<p>If hook arm does not unload, go to Step 5. of this Fault.</p>		

Direct Support and General Support Maintenance (Cont)

5-7. DIRECT/GENERAL SUPPORT TROUBLESHOOTING PROCEDURES (CONT).

Table 5-2. Direct Support/General Support Troubleshooting (CONT)

Malfunction	Test or Inspection	Corrective Action
LOAD HANDLING SYSTEM (LHS)		
4. HOOK ARM DOES NOT UNLOAD (CONT).		
<u>WARNING</u>		
<p>Do not get under LHS when disconnecting or connecting connectors or hoses. A hydraulic malfunction could cause LHS to lower causing serious injury or death.</p>		
Step 4.	<p>Use joystick to operate hook arm unload function with harness connector disconnected from safe lowering solenoid valve on port VB side of LH hook arm manifold and hook arm safe lowering button pushed in.</p>	
	<p>If hook arm does not unload, load control valve is faulty. Repair RH hook arm manifold at port VB (Para 5-36).</p>	
	<p>If hook arm unloads, load control valve is faulty. Repair LH hook arm manifold at port VB (Para 5-36).</p>	

Direct Support and General Support Maintenance (Cont)

Table 5-2. Direct Support/General Support Troubleshooting (CONT)

Malfunction	Test or Inspection	Corrective Action
LOAD HANDLING SYSTEM (LHS)		
4. HOOK ARM DOES NOT UNLOAD (CONT).		
<u>WARNING</u>		
<p>Do not get under LHS when disconnecting or connecting connectors or hoses. A hydraulic malfunction could cause LHS to lower causing serious injury or death.</p>		
Step 5.	<p>Use joystick to operate hook arm unload function with harness connector disconnected from safe lowering solenoid valve on port VA side of RH hook arm manifold and hook arm safe lowering button pushed in.</p>	
	<p>If hook arm does not unload, load control valve is faulty. Repair RH hook arm manifold at port VA (Para 5-36).</p>	
	<p>If hook arm unloads, load control valve is faulty. Repair LH hook arm manifold at port VA (Para 5-36).</p>	

Direct Support and General Support Maintenance (Cont)

5-7. DIRECT/GENERAL SUPPORT TROUBLESHOOTING PROCEDURES (CONT).

Table 5-2. Direct Support/General Support Troubleshooting (CONT)

Malfunction	Test or Inspection	Corrective Action
LOAD HANDLING SYSTEM (LHS)		
4. HOOK ARM DOES NOT UNLOAD (CONT).		
WARNING		
<ul style="list-style-type: none"> • The LHS hydraulic system operates at oil pressures up to 1,725 psi (11 894 kPa). Never disconnect any hydraulic line or fitting without first dropping pressure to zero. Failure to comply may result in serious injury or death to personnel. • Fuel and oil are slippery and can cause falls. To avoid injury, wipe up spilled fuel or oil with rags. • Do not get under LHS when disconnecting or connecting connectors and hoses. A hydraulic malfunction could cause LHS to lower causing serious injury or death. 		
NOTE		
<ul style="list-style-type: none"> • Hose 2917 is disconnected while installing and removing flowmeter. Hose 2917 must be connected during test. • Shut off engine (TM 9-2320-279-10). 		
Step 6.	Check hydraulic flow at LH hook arm manifold, port VB with LHS in transit position while holding joystick in LOAD position, while attempting to load.	
If more than 0 gpm (0 lpm) is present replace LH hook arm cylinder (Para 5-37).		

Direct Support and General Support Maintenance (Cont)

Table 5-2. Direct Support/General Support Troubleshooting (CONT)

Malfunction	Test or Inspection	Corrective Action
LOAD HANDLING SYSTEM (LHS)		
4. HOOK ARM DOES NOT UNLOAD (CONT).		
<u>WARNING</u>		
<ul style="list-style-type: none"> • The LHS hydraulic system operates at oil pressures up to 1,725 psi (11 894 kPa). Never disconnect any hydraulic line or fitting without first dropping pressure to zero. Failure to comply may result in serious injury or death to personnel. • Fuel and oil are slippery and can cause falls. To avoid injury, wipe up spilled fuel or oil with rags. • Do not get under LHS when disconnecting or connecting connectors and hoses. A hydraulic malfunction could cause LHS to lower causing serious injury or death. 		
<u>NOTE</u>		
<ul style="list-style-type: none"> • Hose 2917 is disconnected while installing and removing flowmeter. Hose 2917 must be connected during test. • Shut off engine (TM 9-2320-279-10). 		
Step 7.	Check flow at RH hook arm manifold, port VB with hook arm up completely while holding joystick in UNLOAD position, while attempting to unload.	
If more than 0 gpm (0 lpm) is present, replace RH hook arm cylinder (Para 5-37).		

Direct Support and General Support Maintenance (Cont)

5-7. DIRECT/GENERAL SUPPORT TROUBLESHOOTING PROCEDURES (CONT).

Table 5-2. Direct Support/General Support Troubleshooting (CONT)

Malfunction	Test or Inspection	Corrective Action
LOAD HANDLING SYSTEM (LHS)		
4. HOOK ARM DOES NOT UNLOAD (CONT).		
<p>Step 8. Check for proper hook arm loading.</p> <p style="padding-left: 40px;">If hook arm does not unload, fault not corrected. Notify supervisor.</p>		

Direct Support and General Support Maintenance (Cont)

Table 5-2. Direct Support/General Support Troubleshooting (CONT)

Malfunction	Test or Inspection	Corrective Action
LOAD HANDLING SYSTEM (LHS)		
5. LOSS OF HOOK ARM LOAD HOLDING.		
<u>WARNING</u>		
<p>All personnel must stand clear during lifting operations. A swinging or shifting load may cause injury or death to personnel.</p>		
<u>NOTE</u>		
<p>Lift truck only enough to lift vehicle weight off suspension. Do not lift tires off the ground.</p>		
<p>Step 1. Check hook arm's ability to hold a load against direction of loading.</p>		
<p style="padding-left: 40px;">If hook arm does not hold weight off vehicle suspension go to Step 6. of this Fault.</p>		

Direct Support and General Support Maintenance (Cont)

5-7. DIRECT/GENERAL SUPPORT TROUBLESHOOTING PROCEDURES (CONT).

Table 5-2. Direct Support/General Support Troubleshooting (CONT)

Malfunction Test or Inspection	Corrective Action
LOAD HANDLING SYSTEM (LHS)	
5. LOSS OF HOOK ARM LOAD HOLDING (CONT).	
<u>WARNING</u>	
<ul style="list-style-type: none"> • The LHS hydraulic system operates at oil pressures up to 1,725 psi (11 894 kPa). Never disconnect any hydraulic line or fitting without first dropping pressure to zero. Failure to comply may result in serious injury or death to personnel. • Fuel and oil are slippery and can cause falls. To avoid injury, wipe up spilled fuel or oil with rags. • Do not get under LHS when disconnecting or connecting connectors or hoses. A hydraulic malfunction could cause LHS to lower causing serious injury. 	
<u>NOTE</u>	
Use drain pan to catch leaking hydraulic oil.	
Step 2.	Check for fluid leaks from LH and RH hook arm manifold, port VB with main frame up and hook arm loaded.
<p>Disconnect and plug hoses 2881 and 2892 from hook arm manifold, port VB. Let excess oil in manifold drain. If hydraulic fluid continues to drain from LH or RH hook arm manifold at port VB, replace load control valve at leaking port VB (Para 5-36).</p>	

Direct Support and General Support Maintenance (Cont)

Table 5-2. Direct Support/General Support Troubleshooting (CONT)

Malfunction	Test or Inspection	Corrective Action
LOAD HANDLING SYSTEM (LHS)		
5. LOSS OF HOOK ARM LOAD HOLDING (CONT).		
<p>The diagram illustrates the hydraulic system for the Load Handling System (LHS). It includes a side view of the truck, a close-up of the hook arm manifold showing quick disconnects and hose 2917, and a detailed view of the main frame bulkhead. The detailed view shows the main frame bulkhead, flowmeter (with IN and OUT ports), load valve, adapter hose, and hose 2891.</p>		
WARNING		
<ul style="list-style-type: none"> • The LHS hydraulic system operates at oil pressures up to 1,725 psi (11 894 kPa). Never disconnect any hydraulic line or fitting without first dropping pressure to zero. Failure to comply may result in serious injury or death to personnel. • Fuel and oil are slippery and can cause falls. To avoid injury, wipe up spilled fuel or oil with rags. • Do not get under LHS when disconnecting or connecting connectors or hoses. A hydraulic malfunction could cause LHS to lower causing serious injury. 		
NOTE		
<ul style="list-style-type: none"> • Shut off engine (TM 9-2320-279-10) to connect flowmeter. • Hose 2917 is disconnected while installing and removing the flowmeter. Hose 2917 must be connected during test. 		
Step 3.	Check flow at LH hook arm manifold, port VA with LHS in transit position while holding joystick in LOAD position.	
If more than 0 gpm (0 lpm) is present, replace LH hook arm cylinder (Para 5-37).		

Direct Support and General Support Maintenance (Cont)

5-7. DIRECT/GENERAL SUPPORT TROUBLESHOOTING PROCEDURES (CONT).

Table 5-2. Direct Support/General Support Troubleshooting (CONT)

Malfunction	Test or Inspection	Corrective Action
-------------	--------------------	-------------------

LOAD HANDLING SYSTEM (LHS)

5. LOSS OF HOOK ARM LOAD HOLDING (CONT).

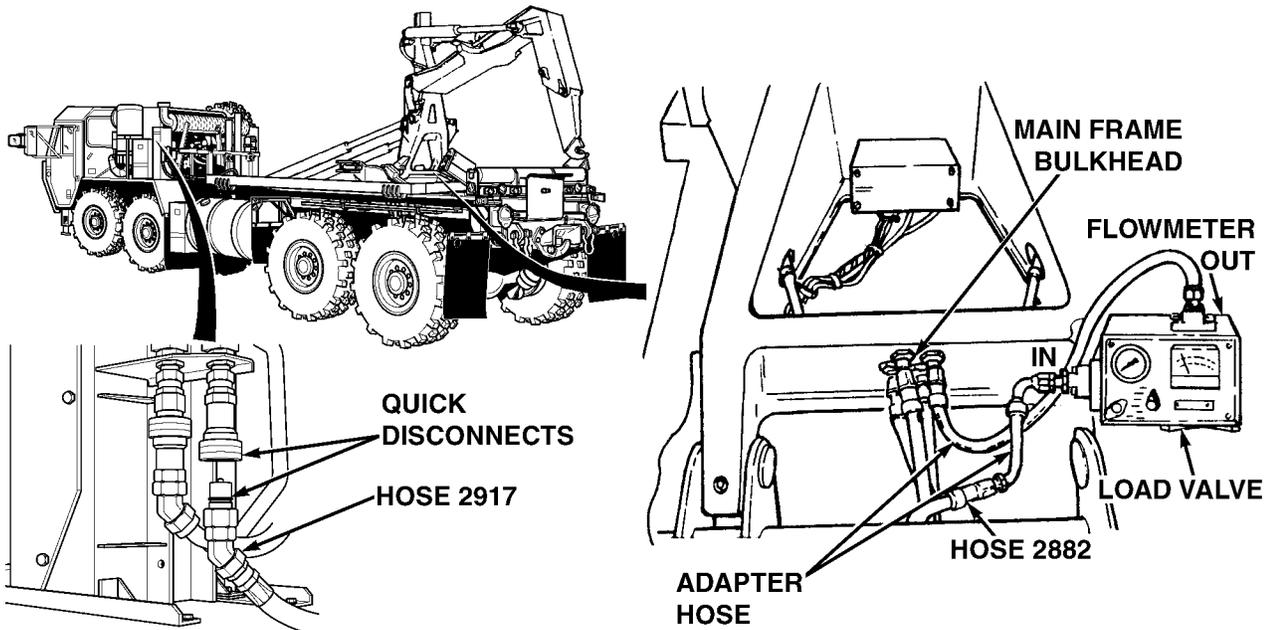

WARNING

- The LHS hydraulic system operates at oil pressures up to 1,725 psi (11 894 kPa). Never disconnect any hydraulic line or fitting without first dropping pressure to zero. Failure to comply may result in serious injury or death to personnel.
- Fuel and oil are slippery and can cause falls. To avoid injury, wipe up spilled fuel or oil with rags.
- Do not get under LHS when disconnecting or connecting connectors or hoses. A hydraulic malfunction could cause LHS to lower causing serious injury.

NOTE

- Shut off engine (TM 9-2320-279-10) to connect flowmeter.
- Hose 2917 is disconnected while installing and removing flowmeter. Hose 2917 must be connected during test.

Step 4. Check flow at RH hook arm manifold, port VA with LHS in transit position while holding joystick in LOAD position.

If more than 0 gpm (0 lpm) is present, replace RH hook arm cylinder (Para 5-37).

Direct Support and General Support Maintenance (Cont)

Table 5-2. Direct Support/General Support Troubleshooting (CONT)

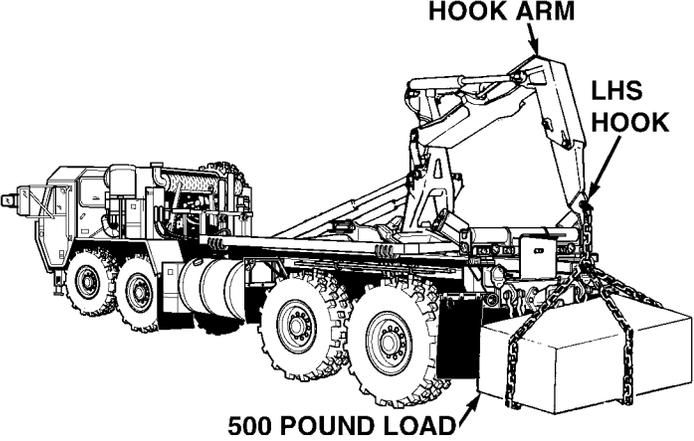
Malfunction	Test or Inspection	Corrective Action
LOAD HANDLING SYSTEM (LHS)		
5. LOSS OF HOOK ARM LOAD HOLDING (CONT).		
 <p>The diagram shows a side view of a truck-mounted crane. The crane's hook arm is extended upwards and to the right, holding a rectangular load. The load is secured with chains. Labels with arrows point to the 'HOOK ARM' at the top, the 'LHS HOOK' where the arm meets the truck chassis, and the '500 POUND LOAD' at the bottom of the load.</p>		
<u>WARNING</u>		
All personnel must stand clear during lifting operations. A swinging or shifting load may cause injury or death to personnel.		
Step 5. Check hook arm's ability to hold a load against direction of unloading.		
If hook arm does not hold load fault not corrected. Notify supervisor.		

Direct Support and General Support Maintenance (Cont)

5-7. DIRECT/GENERAL SUPPORT TROUBLESHOOTING PROCEDURES (CONT).

Table 5-2. Direct Support/General Support Troubleshooting (CONT)

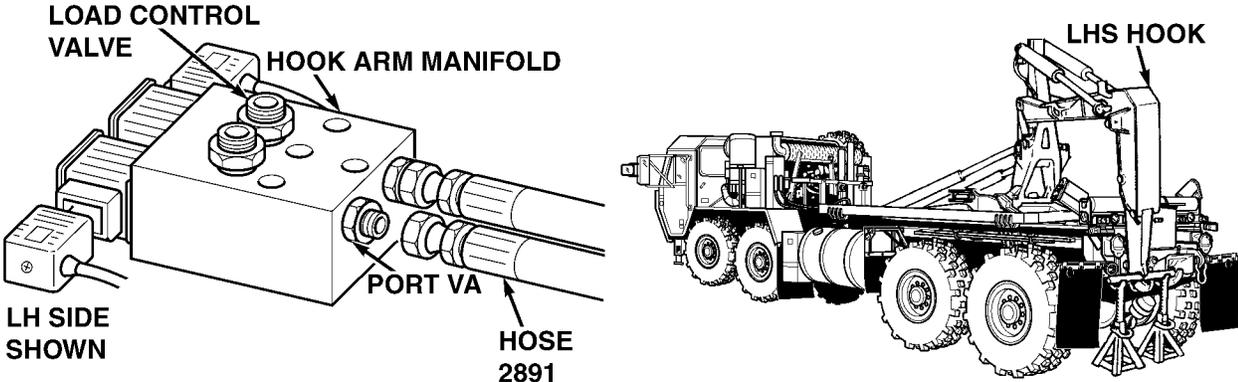
Malfunction	Test or Inspection	Corrective Action
LOAD HANDLING SYSTEM (LHS)		
5. LOSS OF HOOK ARM LOAD HOLDING (CONT).		
 <p>The diagram shows a close-up of the hook arm manifold on the left, with labels for 'LOAD CONTROL VALVE', 'HOOK ARM MANIFOLD', 'PORT VA', and 'HOSE 2891'. The 'LH SIDE SHOWN' label is also present. On the right, a side view of the truck shows the 'LHS HOOK' assembly.</p>		
<u>WARNING</u>		
<ul style="list-style-type: none"> • All personnel must stand clear during lifting operations. A swinging or shifting load may cause injury or death to personnel. • Do not get under LHS when disconnecting or connecting connectors or hoses. A hydraulic malfunction could cause LHS to lower causing serious injury. 		
<u>NOTE</u>		
Lift truck only enough to lift truck's weight off suspension. Do not lift tires off the ground.		
Step 6.	Check for fluid leaks from LH or RH hook arm manifold, port VA with main frame up and hook arm loaded.	Disconnect and plug hoses 2891 and 2882 from hook arm manifold, port VA. If fluid leaks from LH or RH hook arm manifold where hose is removed, replace load control valve at leaking port of VA (Para 5-36).

Direct Support and General Support Maintenance (Cont)

Table 5-2. Direct Support/General Support Troubleshooting (CONT)

Malfunction	Test or Inspection	Corrective Action
LOAD HANDLING SYSTEM (LHS)		
5. LOSS OF HOOK ARM LOAD HOLDING (CONT).		
WARNING		
<ul style="list-style-type: none"> • The LHS hydraulic system operates at oil pressures up to 1,725 psi (11 894 kPa). Never disconnect any hydraulic line or fitting without first dropping pressure to zero. Failure to comply may result in serious injury or death to personnel. • Fuel and oil are slippery and can cause falls. To avoid injury, wipe up spilled fuel or oil with rags. • Do not get under LHS when disconnecting or connecting connectors or hoses. A hydraulic malfunction could cause LHS to lower causing serious injury. 		
NOTE		
<ul style="list-style-type: none"> • Shut off engine (TM 9-2320-279-10) to connect flowmeter. • Hose 2917 is disconnected while installing and removing the flowmeter. Hose 2917 must be connected during test. 		
Step 7.	Check flow at LH hook arm manifold, port VB with hook arm up completely while holding joystick in UNLOAD position.	
If more than 0 gpm (0 lpm) is present, replace LH hook arm cylinder (Para 5-37).		

Direct Support and General Support Maintenance (Cont)

5-7. DIRECT/GENERAL SUPPORT TROUBLESHOOTING PROCEDURES (CONT).

Table 5-2. Direct Support/General Support Troubleshooting (CONT)

Malfunction	Test or Inspection	Corrective Action
LOAD HANDLING SYSTEM (LHS)		
5. LOSS OF HOOK ARM LOAD HOLDING (CONT).		
WARNING		
<ul style="list-style-type: none"> • The LHS hydraulic system operates at oil pressures up to 1,725 psi (11 894 kPa). Never disconnect any hydraulic line or fitting without first dropping pressure to zero. Failure to comply may result in serious injury or death to personnel. • Fuel and oil are slippery and can cause falls. To avoid injury, wipe up spilled fuel or oil with rags. • Do not get under LHS when disconnecting or connecting connectors or hoses. A hydraulic malfunction could cause LHS to lower causing serious injury. 		
NOTE		
<ul style="list-style-type: none"> • Shut off engine (TM 9-2320-279-10) to connect gage. • Hose 2917 is disconnected while installing and removing flowmeter. Hose 2917 must be connected during test. 		
Step 8.	Check flow at RH hook arm manifold, port VB with hook arm up completely while holding joystick in UNLOAD position.	
If more than 0 gpm (0 lpm) is present, replace RH hook arm cylinder (Para 5-37).		

Direct Support and General Support Maintenance (Cont)

Table 5-2. Direct Support/General Support Troubleshooting (CONT)

Malfunction	Test or Inspection	Corrective Action
LOAD HANDLING SYSTEM (LHS)		
5. LOSS OF HOOK ARM LOAD HOLDING (CONT).		
<u>WARNING</u>		
<p>All personnel must stand clear during lifting operations. A swinging or shifting load may cause injury or death to personnel.</p>		
<u>NOTE</u>		
<p>Lift truck only enough to lift truck's weight off suspension. Do not lift tire off the ground.</p>		
Step 9.	Check hook arm operation, check for proper hold of load against direction of loading.	<p>If hook arm does not hold weight off vehicle suspension, fault not corrected. Notify supervisor.</p>

Direct Support and General Support Maintenance (Cont)

5-7. DIRECT/GENERAL SUPPORT TROUBLESHOOTING PROCEDURES (CONT).

Table 5-2. Direct Support/General Support Troubleshooting (CONT)

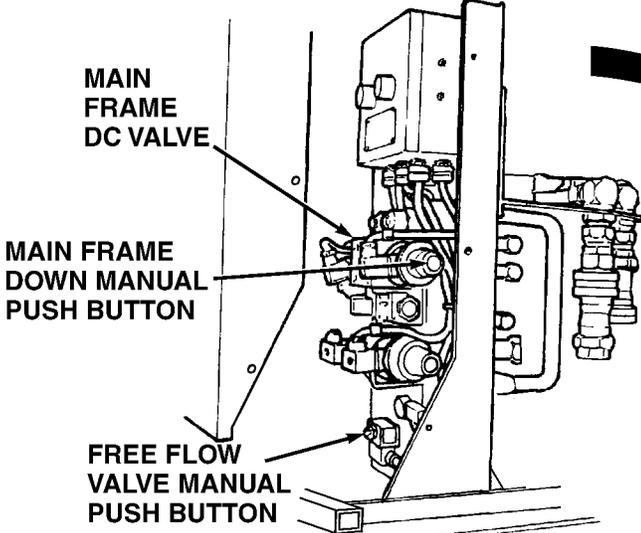
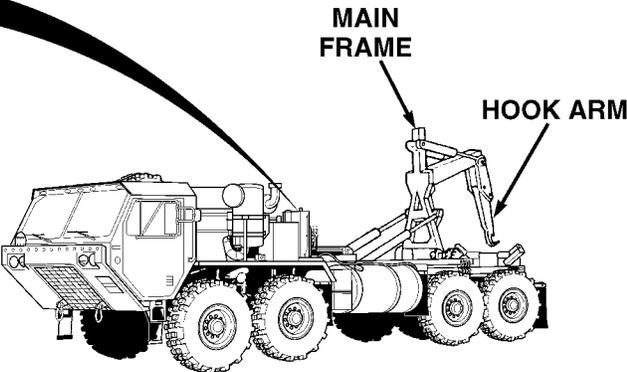
Malfunction	Test or Inspection	Corrective Action
LOAD HANDLING SYSTEM (LHS)		
6. MAIN FRAME DOES NOT LOAD.		
NOTE		
For Fault 6 the engine must be running, PTO engaged, and hydraulic selector switch in MAN M.F. position.		
		
<p>Step 1. Check operation of main frame loading using directional control valve manual push button and free flow valve manual push button.</p>	<p>If main frame loads, replace main frame down directional control valve (Para 5-35).</p>	

Direct Support and General Support Maintenance (Cont)

Table 5-2. Direct Support/General Support Troubleshooting (CONT)

Malfunction	Test or Inspection	Corrective Action
LOAD HANDLING SYSTEM (LHS)		
6. MAIN FRAME DOES NOT LOAD (CONT).		
<p>The diagram illustrates the hydraulic system for the main frame. On the left, a 'MAIN MANIFOLD' is shown with a 'PORT TPMA' and a 'PRESSURE GAGE'. A 'HOSE 2917' is connected to the manifold. In the center, a side view of the truck chassis shows the 'RH SIDE' and 'LH SIDE' of the main frame. On the 'RH SIDE', hoses '2890', '2887', and '2666' are shown. On the 'LH SIDE', hoses '2588', '2888', and '2889' are shown. Arrows indicate the flow of hydraulic fluid from the manifold to the main frame cylinders.</p>		
WARNING		
<ul style="list-style-type: none"> • The LHS hydraulic system operates at oil pressures up to 1,725 psi (11 894 kPa). Never disconnect any hydraulic line or fitting without first dropping pressure to zero. Failure to comply may result in serious injury or death to personnel. • Fuel and oil are slippery and can cause falls. To avoid injury, wipe up spilled fuel or oil with rags. 		
NOTE		
<ul style="list-style-type: none"> • Shut off engine (TM 9-2320-279-10) to connect gage. • Hose 2917 is disconnected while installing and removing pressure gage. Hose 2917 must be connected during test. 		
Step 2.	Check hydraulic pressure at main manifold, port TPMA, with hoses 2888, 2887, 2588, 2666, 2889, and 2890 capped and LHS joystick held in LOAD position.	
	If 1,725 psi (11 894 kPa) is not present, replace LH (outboard) main frame cylinder manifold load control valve (Para 5-41).	

Direct Support and General Support Maintenance (Cont)

5-7. DIRECT/GENERAL SUPPORT TROUBLESHOOTING PROCEDURES (CONT).

Table 5-2. Direct Support/General Support Troubleshooting (CONT)

Malfunction	Test or Inspection	Corrective Action
LOAD HANDLING SYSTEM (LHS)		
6. MAIN FRAME DOES NOT LOAD (CONT).		
<u>WARNING</u>		
<ul style="list-style-type: none"> • The LHS hydraulic system operates at oil pressures up to 1,725 psi (11 894 kPa). Never disconnect any hydraulic line or fitting without first dropping pressure to zero. Failure to comply may result in serious injury or death to personnel. • Fuel and oil are slippery and can cause falls. To avoid injury, wipe up spilled fuel or oil with rags. 		
<u>NOTE</u>		
<ul style="list-style-type: none"> • Shut off engine (TM 9-2320-279-10) to connect gage. • Hose 2917 is disconnected while installing and removing pressure gage. Hose 2917 must be connected during test. 		
<p>Step 3. Check pressure at RH main frame cylinder manifold, port T, when attempting to load.</p>		
<p style="padding-left: 40px;">If more than 0 psi (0 kPa) is present, repair RH main frame cylinder manifold (Para 5-39).</p>		

Direct Support and General Support Maintenance (Cont)

Table 5-2. Direct Support/General Support Troubleshooting (CONT)

Malfunction	Test or Inspection	Corrective Action
LOAD HANDLING SYSTEM (LHS)		
6. MAIN FRAME DOES NOT LOAD (CONT).		
WARNING		
<ul style="list-style-type: none"> • The LHS hydraulic system operates at oil pressures up to 1,725 psi (11 894 kPa). Never disconnect any hydraulic line or fitting without first dropping pressure to zero. Failure to comply may result in serious injury or death to personnel. • Fuel and oil are slippery and can cause falls. To avoid injury, wipe up spilled fuel or oil with rags. 		
NOTE		
<ul style="list-style-type: none"> • Shut off engine (TM 9-2320-279-10) to connect gage. • Hose 2917 is disconnected while installing and removing pressure gage. Hose 2917 must be connected during test. 		
Step 4.	Check hydraulic pressure at LH main frame cylinder manifold, port T, when attempting to load.	If more than 0 psi (0 kPa) is present, repair LH main frame cylinder manifold (Para 5-39).

Direct Support and General Support Maintenance (Cont)

5-7. DIRECT/GENERAL SUPPORT TROUBLESHOOTING PROCEDURES (CONT).

Table 5-2. Direct Support/General Support Troubleshooting (CONT)

Malfunction	Test or Inspection	Corrective Action
LOAD HANDLING SYSTEM (LHS)		
6. MAIN FRAME DOES NOT LOAD (CONT).		
<p>The diagram illustrates the hydraulic system for the Load Handling System (LHS). On the left, a detailed view of the main manifold is shown, featuring a 'PORT TPMA' (Test Point Manifold Assembly) and a 'PRESSURE GAGE' connected to the system. A 'HOSE 2917' is also shown connected to the manifold. On the right, a side view of the truck chassis is shown, with a hose extending from the chassis to the manifold assembly.</p>		
<u>WARNING</u>		
<ul style="list-style-type: none"> • The LHS hydraulic system operates at oil pressures up to 1,725 psi (11 894 kPa). Never disconnect any hydraulic line or fitting without first dropping pressure to zero. Failure to comply may result in serious injury or death to personnel. • Fuel and oil are slippery and can cause falls. To avoid injury, wipe up spilled fuel or oil with rags. 		
<u>NOTE</u>		
<ul style="list-style-type: none"> • Shut off engine (TM 9-2320-279-10) to connect gage. • Hose 2917 is disconnected while installing and removing pressure gage. Hose 2917 must be connected during test. 		
<p>Step 5. Check hydraulic pressure at main manifold, port TPMA, when attempting to load.</p>		
<p style="padding-left: 40px;">If more than 1,375 psi (9 480 kPa) is present, replace RH (inboard) main frame cylinder manifold load control valve (Para 5-41).</p>		

Direct Support and General Support Maintenance (Cont)

Table 5-2. Direct Support/General Support Troubleshooting (CONT)

Malfunction	Test or Inspection	Corrective Action
LOAD HANDLING SYSTEM (LHS)		
6. MAIN FRAME DOES NOT LOAD (CONT).		
<p>The diagram illustrates the hydraulic testing setup. On the left, a truck is shown with a hose connected to a manifold. Labels point to 'QUICK DISCONNECTS' and 'HOSE 2917'. On the right, a detailed view of the manifold shows 'LH MAIN CYLINDER MANIFOLD', 'ADAPTER HOSE', 'PORT VA', 'HOSE 2888', and 'OUT'. Below this, a 'FLOWMETER' is connected to the 'IN' port, and a 'LOAD VALVE' is shown on the front panel.</p>		
WARNING		
<ul style="list-style-type: none"> • The LHS hydraulic system operates at oil pressures up to 1,725 psi (11 894 kPa). Never disconnect any hydraulic line or fitting without first dropping pressure to zero. Failure to comply may result in serious injury or death to personnel. • Fuel and oil are slippery and can cause falls. To avoid injury, wipe up spilled fuel or oil with rags. 		
NOTE		
<ul style="list-style-type: none"> • Shut off engine (TM 9-2320-279-10) to connect flowmeter. • Hose 2917 is disconnected while installing and removing the pressure gage. Hose 2917 must be connected during test. 		
Step 6.	Check flow at LH main frame cylinder manifold, port VA, with LHS in transit position while holding joystick in LOAD position.	
If more than 0 gpm (0 lpm) is present, replace LH main frame cylinder (Para 5-40).		

Direct Support and General Support Maintenance (Cont)

5-7. DIRECT/GENERAL SUPPORT TROUBLESHOOTING PROCEDURES (CONT).

Table 5-2. Direct Support/General Support Troubleshooting (CONT)

Malfunction	Test or Inspection	Corrective Action
LOAD HANDLING SYSTEM (LHS)		
6. MAIN FRAME DOES NOT LOAD (CONT).		
<u>WARNING</u>		
<ul style="list-style-type: none"> • The LHS hydraulic system operates at oil pressures up to 1,725 psi (11 894 kPa). Never disconnect any hydraulic line or fitting without first dropping pressure to zero. Failure to comply may result in serious injury or death to personnel. • Fuel and oil are slippery and can cause falls. To avoid injury, wipe up spilled fuel or oil with rags. 		
<u>NOTE</u>		
<ul style="list-style-type: none"> • Shut off engine (TM 9-2320-279-10) to connect gage. • Hose 2917 is disconnected while installing and removing pressure gage. Hose 2917 must be connected during test. 		
Step 7.	Check flow at RH main frame cylinder manifold, port VA with LHS in transit position while holding joystick in LOAD position.	
If more than 0 gpm (0 lpm) is present, replace RH main frame cylinder (Para 5-37).		

Direct Support and General Support Maintenance (Cont)

Table 5-2. Direct Support/General Support Troubleshooting (CONT)

Malfunction	Test or Inspection	Corrective Action
LOAD HANDLING SYSTEM (LHS)		
6. MAIN FRAME DOES NOT LOAD (CONT).		
<p>The diagram illustrates the operator's control panel and the vehicle's Load Handling System (LHS). On the left, a detailed view of the control panel shows a steering wheel removed for clarity, a hydraulic selector switch, and an engine switch. On the right, a side view of the vehicle shows the LHS mounted on the rear. Labels include 'HYDRAULIC SELECTOR SWITCH', 'STEERING WHEEL SHOWN REMOVED FOR CLARITY', 'ENGINE SWITCH', and 'LHS'.</p>		
Step 8. Operate main frame, check of proper loading.		
If main frame does not load, fault not corrected. Notify supervisor.		

Direct Support and General Support Maintenance (Cont)

5-7. DIRECT/GENERAL SUPPORT TROUBLESHOOTING PROCEDURES (CONT).

Table 5-2. Direct Support/General Support Troubleshooting (CONT)

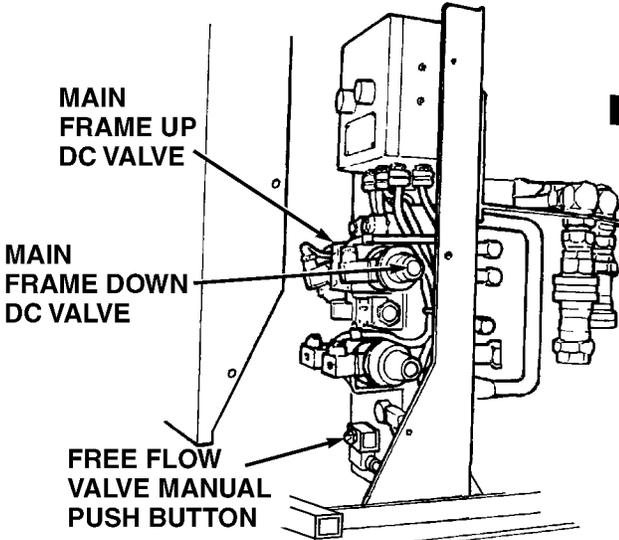
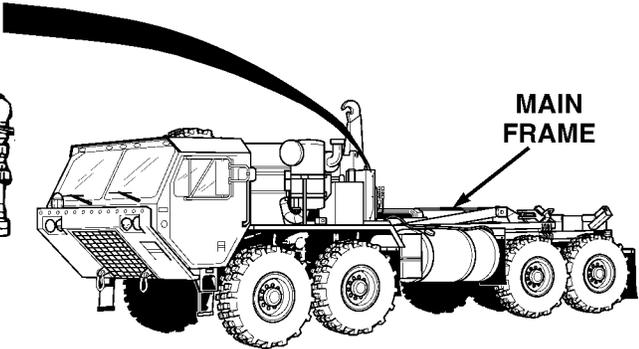
Malfunction	Test or Inspection	Corrective Action
LOAD HANDLING SYSTEM (LHS)		
7. MAIN FRAME DOES NOT UNLOAD.		
NOTE		
<ul style="list-style-type: none"> • For Fault 7 engine must be running, PTO engaged, and hydraulic selector switch in MAN M.F. position. • Raise hook-arm until LHS NO TRANSIT light is on. 		
 <p>Diagram showing hydraulic control valves. Labels include: MAIN FRAME UP DC VALVE, MAIN FRAME DOWN DC VALVE, and FREE FLOW VALVE MANUAL PUSH BUTTON.</p>	 <p>Diagram of a truck with a hook arm. Label: MAIN FRAME.</p>	
NOTE		
Ensure button is pushed past free play to engage.		
Step 1.	Operate main frame using main frame up directional control valve manual push button and free flow valve manual push button.	
	If hook arm unloads, replace main frame up directional control valve (Para 5-41).	

Direct Support and General Support Maintenance (Cont)

Table 5-2. Direct Support/General Support Troubleshooting (CONT)

Malfunction	Test or Inspection	Corrective Action
LOAD HANDLING SYSTEM (LHS)		
7. MAIN FRAME DOES NOT UNLOAD (CONT).		
WARNING		
<ul style="list-style-type: none"> • The LHS hydraulic system operates at oil pressures up to 1,725 psi (11 894 kPa). Never disconnect any hydraulic line or fitting without first dropping pressure to zero. Failure to comply may result in serious injury or death to personnel. • Fuel and oil are slippery and can cause falls. To avoid injury, wipe up spilled fuel or oil with rags. 		
NOTE		
<ul style="list-style-type: none"> • Shut off engine (TM 9-2320-279-10) to connect gage. • Hose 2917 is disconnected while installing and removing pressure gage. Hose 2917 must be connected during test. 		
Step 2.	Check hydraulic pressure at main manifold, port TPMB, with hoses 2888, 2887, 2588, 2666, 2889, and 2890 capped and LHS joystick held in UNLOAD position.	
If less than 1,725 psi (11 894 kPa) is present, replace RH (inboard) main frame cylinder load control valve (Para 5-41).		

Direct Support and General Support Maintenance (Cont)

5-7. DIRECT/GENERAL SUPPORT TROUBLESHOOTING PROCEDURES (CONT).

Table 5-2. Direct Support/General Support Troubleshooting (CONT)

Malfunction	Test or Inspection	Corrective Action
LOAD HANDLING SYSTEM (LHS)		
7. MAIN FRAME DOES NOT UNLOAD (CONT).		
WARNING		
<ul style="list-style-type: none"> • The LHS hydraulic system operates at oil pressures up to 1,725 psi (11 894 kPa). Never disconnect any hydraulic line or fitting without first dropping pressure to zero. Failure to comply may result in serious injury or death to personnel. • Fuel and oil are slippery and can cause falls. To avoid injury, wipe up spilled fuel or oil with rags. 		
NOTE		
<ul style="list-style-type: none"> • Shut off engine (TM 9-2320-279-10) to connect gage. • Hose 2917 is disconnected while installing and removing pressure gage. Hose 2917 must be connected during test. 		
Step 3.	<p>Check pressure at RH main frame cylinder manifold, port T, when attempting to unload.</p> <p>If more than 0 psi (0 kPa) is present, relief valve is faulty. Repair RH main frame cylinder manifold (Para 5-39).</p>	

Direct Support and General Support Maintenance (Cont)

Table 5-2. Direct Support/General Support Troubleshooting (CONT)

Malfunction	Test or Inspection	Corrective Action
LOAD HANDLING SYSTEM (LHS)		
7. MAIN FRAME DOES NOT UNLOAD (CONT).		
<u>WARNING</u>		
<ul style="list-style-type: none"> • The LHS hydraulic system operates at oil pressures up to 1,725 psi (11 894 kPa). Never disconnect any hydraulic line or fitting without first dropping pressure to zero. Failure to comply may result in serious injury or death to personnel. • Fuel and oil are slippery and can cause falls. To avoid injury, wipe up spilled fuel or oil with rags. 		
<u>NOTE</u>		
<ul style="list-style-type: none"> • Shut off engine (TM 9-2320-279-10) to connect gage. • Hose 2917 is disconnected while installing and removing pressure gage. Hose 2917 must be connected during test. 		
Step 4.	Check pressure at LH main frame cylinder manifold, port T, when attempting to unload.	If more than 0 psi (0 kPa) is present, relief valve is faulty. Repair LH main frame cylinder manifold (Para 5-39).

Direct Support and General Support Maintenance (Cont)

5-7. DIRECT/GENERAL SUPPORT TROUBLESHOOTING PROCEDURES (CONT).

Table 5-2. Direct Support/General Support Troubleshooting (CONT)

Malfunction Test or Inspection	Corrective Action
LOAD HANDLING SYSTEM (LHS)	
7. MAIN FRAME DOES NOT UNLOAD (CONT).	
<u>WARNING</u>	
<ul style="list-style-type: none"> • The LHS hydraulic system operates at oil pressures up to 1,725 psi (11 894 kPa). Never disconnect any hydraulic line or fitting without first dropping pressure to zero. Failure to comply may result in serious injury or death to personnel. • Fuel and oil are slippery and can cause falls. To avoid injury, wipe up spilled fuel or oil with rags. 	
<u>NOTE</u>	
<ul style="list-style-type: none"> • Shut off engine (TM 9-2320-279-10) to connect gage. • Hose 2917 is disconnected while installing and removing pressure gage. Hose 2917 must be connected during test. 	
<p>Step 5. Check pressure at cylinder main manifold, port TPMB, when attempting to unload.</p>	<p>If more than 1,375 psi (9 480 kPa) is present, replace LH (outboard) load control valve (Para 5-41).</p>

Direct Support and General Support Maintenance (Cont)

Table 5-2. Direct Support/General Support Troubleshooting (CONT)

Malfunction	Test or Inspection	Corrective Action
LOAD HANDLING SYSTEM (LHS)		
7. MAIN FRAME DOES NOT UNLOAD (CONT).		
WARNING		
<ul style="list-style-type: none"> • The LHS hydraulic system operates at oil pressures up to 1,725 psi (11 894 kPa). Never disconnect any hydraulic line or fitting without first dropping pressure to zero. Failure to comply may result in serious injury or death to personnel. • Fuel and oil are slippery and can cause falls. To avoid injury, wipe up spilled fuel or oil with rags. 		
NOTE		
<ul style="list-style-type: none"> • Shut off engine (TM 9-2320-279-10) to connect gage. • Hose 2917 is disconnected while installing and removing pressure gage. Hose 2917 must be connected during test. 		
Step 6.	Check flow at LH main frame cylinder manifold, port VB, with LHS in transit position while holding joystick in UNLOAD position. Attempt to unload main frame completely.	
	If more than 0 gpm (0 lpm) is present with stationary cylinder, replace LH main frame cylinder (Para 5-40).	

Direct Support and General Support Maintenance (Cont)

5-7. DIRECT/GENERAL SUPPORT TROUBLESHOOTING PROCEDURES (CONT).

Table 5-2. Direct Support/General Support Troubleshooting (CONT)

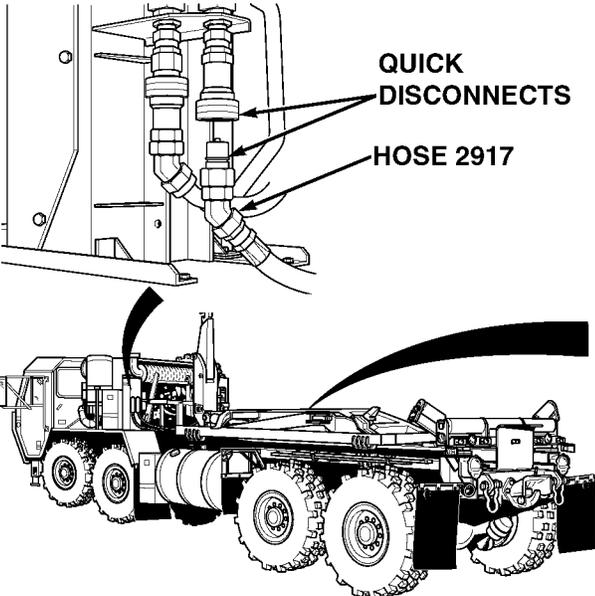
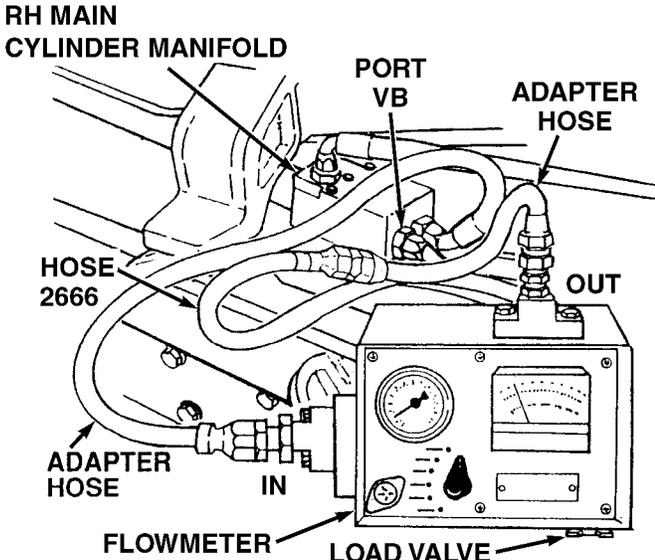
Malfunction Test or Inspection	Corrective Action
LOAD HANDLING SYSTEM (LHS)	
7. MAIN FRAME DOES NOT UNLOAD (CONT).	
 <p>QUICK DISCONNECTS HOSE 2917</p>	 <p>RH MAIN CYLINDER MANIFOLD PORT VB ADAPTER HOSE HOSE 2666 IN FLOWMETER LOAD VALVE OUT</p>
WARNING	
<ul style="list-style-type: none"> The LHS hydraulic system operates at oil pressures up to 1,725 psi (11 894 kPa). Never disconnect any hydraulic line or fitting without first dropping pressure to zero. Failure to comply may result in serious injury or death to personnel. Fuel and oil are slippery and can cause falls. To avoid injury, wipe up spilled fuel or oil with rags. 	
NOTE	
<ul style="list-style-type: none"> Shut off engine (TM 9-2320-279-10) to connect gage. Hose 2917 is disconnected while installing and removing flowmeter. Hose 2917 must be connected during test. 	
Step 7.	<p>Check flow at RH main frame cylinder manifold, port VB, with LHS in transit position while holding joystick in UNLOAD position. Attempt to unload main frame completely.</p> <p>If more than 0 gpm (0 lpm) is present with stationary cylinder, replace RH main frame cylinder (Para 5-40).</p>

Direct Support and General Support Maintenance (Cont)

Table 5-2. Direct Support/General Support Troubleshooting (CONT)

Malfunction	Test or Inspection	Corrective Action
LOAD HANDLING SYSTEM (LHS)		
7. MAIN FRAME DOES NOT UNLOAD (CONT).		
Step 8. Operate main frame, check for proper unload.		
If main frame does not unload, fault not corrected. Notify supervisor.		

Direct Support and General Support Maintenance (Cont)

5-7. DIRECT/GENERAL SUPPORT TROUBLESHOOTING PROCEDURES (CONT).

Table 5-2. Direct Support/General Support Troubleshooting (CONT)

Malfunction Test or Inspection	Corrective Action
LOAD HANDLING SYSTEM (LHS)	
8. MAIN FRAME DOES NOT OPERATE.	
<p>The diagram illustrates the hydraulic system for the Load Handling System (LHS) on a truck. It shows a central truck chassis with hydraulic lines extending to the right-hand (RH) and left-hand (LH) sides. On the left, a detailed view of the main manifold includes a pressure gage, a port TPMB, and hose 2917. On the RH side, hoses 2890, 2887, and 2666 are shown. On the LH side, hoses 2588, 2888, and 2889 are shown. Arrows indicate the flow of hydraulic fluid from the manifold to the various components.</p>	
WARNING	
<ul style="list-style-type: none"> • The LHS hydraulic system operates at oil pressures up to 1,725 psi (11 894 kPa). Never disconnect any hydraulic line or fitting without first dropping pressure to zero. Failure to comply may result in serious injury or death to personnel. • Fuel and oil are slippery and can cause falls. To avoid injury, wipe up spilled fuel or oil with rags. 	
NOTE	
<ul style="list-style-type: none"> • Shut off engine (TM 9-2320-279-10) to connect gage. • Hose 2917 is disconnected while installing and removing pressure gage. Hose 2917 must be connected during test. 	
Step 1.	Check pressure at main manifold, port TPMB, with LHS in transit position, hoses 2888, 2887, 2588, 2666, 2889, and 2890 capped and joystick held in LOAD position.
If pressure is less than 1,725 psi (11 894 kPa), replace transit valve (Para 5-32).	

Direct Support and General Support Maintenance (Cont)

Table 5-2. Direct Support/General Support Troubleshooting (CONT)

Malfunction	Test or Inspection	Corrective Action
LOAD HANDLING SYSTEM (LHS)		
8. MAIN FRAME DOES NOT OPERATE (CONT).		
<u>WARNING</u>		
<ul style="list-style-type: none"> • The LHS hydraulic system operates at oil pressures up to 1,725 psi (11 894 kPa). Never disconnect any hydraulic line or fitting without first dropping pressure to zero. Failure to comply may result in serious injury or death to personnel. • Fuel and oil are slippery and can cause falls. To avoid injury, wipe up spilled fuel or oil with rags. • Compressed air used for cleaning purposes will not exceed 30 psi (207 kPa). Use only with effective chip guard and personal protective equipment (goggles/shield, gloves, etc.). Failure to comply may result in injury or death to personnel. 		
<u>NOTE</u>		
<p>Hose 2917 is disconnected while installing and removing pressure gage. Hose 2917 must be connected during test.</p>		
<p>Step 2. Check velocity fuses in both LH and RH main frame cylinder manifolds.</p>		
<p style="padding-left: 40px;">If air cannot be blown through velocity fuse, replace velocity fuse (Para 5-39).</p>		

Direct Support and General Support Maintenance (Cont)

5-7. DIRECT/GENERAL SUPPORT TROUBLESHOOTING PROCEDURES (CONT).

Table 5-2. Direct Support/General Support Troubleshooting (CONT)

Malfunction	Test or Inspection	Corrective Action
LOAD HANDLING SYSTEM (LHS)		
8. MAIN FRAME DOES NOT OPERATE (CONT).		
<u>WARNING</u>		
<ul style="list-style-type: none"> • The LHS hydraulic system operates at oil pressures up to 1,725 psi (11 894 kPa). Never disconnect any hydraulic line or fitting without first dropping pressure to zero. Failure to comply may result in serious injury or death to personnel. • Fuel and oil are slippery and can cause falls. To avoid injury, wipe up spilled fuel or oil with rags. 		
<u>NOTE</u>		
<ul style="list-style-type: none"> • Shut off engine (TM 9-2320-279-10) to connect gage. • Hose 2917 is disconnected while installing and removing flowmeter. Hose 2917 must be connected during test. 		
Step 3.	Check flow at RH main frame cylinder manifold, port VA, with LHS in transit position while holding joystick in LOAD position.	
If more than 0 gpm (0 lpm) is present, replace RH main frame cylinder (Para 5-40).		

Direct Support and General Support Maintenance (Cont)

Table 5-2. Direct Support/General Support Troubleshooting (CONT)

Malfunction	Test or Inspection	Corrective Action
LOAD HANDLING SYSTEM (LHS)		
8. MAIN FRAME DOES NOT OPERATE (CONT).		
WARNING		
<ul style="list-style-type: none"> The LHS hydraulic system operates at oil pressures up to 1,725 psi (11 894 kPa). Never disconnect any hydraulic line or fitting without first dropping pressure to zero. Failure to comply may result in serious injury or death to personnel. Fuel and oil are slippery and can cause falls. To avoid injury, wipe up spilled fuel or oil with rags. 		
NOTE		
<ul style="list-style-type: none"> Shut off engine (TM 9-22320-279-10) to connect flowmeter. Hose 2917 is disconnected while installing and removing the flowmeter. Hose 2917 must be connected during test. 		
Step 4.	Check flow at LH main frame cylinder manifold port VA, with LHS in transit position while holding joystick in LOAD position.	
If more than 0 gpm (0 lpm) is present, replace LH main frame cylinder (Para 5-40).		

Direct Support and General Support Maintenance (Cont)

5-7. DIRECT/GENERAL SUPPORT TROUBLESHOOTING PROCEDURES (CONT).

Table 5-2. Direct Support/General Support Troubleshooting (CONT)

Malfunction	Test or Inspection	Corrective Action
LOAD HANDLING SYSTEM (LHS)		
8. MAIN FRAME DOES NOT OPERATE (CONT).		
<u>WARNING</u>		
<p>Main frame and hook arm have a combined weight of 2,100 lbs. (953 kg). Hook arm cylinders weigh 210 lbs. (95 kg) each. Attach suitable lifting device prior to removal or installation to prevent possible injury or death to personnel.</p>		
<u>CAUTION</u>		
<p>Blocks supporting main frame can fall when main frame is supported by a lifting device. Have soldier prevent block from falling, or damage to LHS could occur.</p>		
Step 5.	Check operation of main cylinders with rod lug ends disconnected from main frame.	
	If one cylinder does not move, replace faulty main frame cylinder (Para 5-40).	
	If both cylinders operate, fault not corrected. Notify supervisor.	

Direct Support and General Support Maintenance (Cont)

Table 5-2. Direct Support/General Support Troubleshooting (CONT)

Malfunction	Test or Inspection	Corrective Action
LOAD HANDLING SYSTEM (LHS)		
8. MAIN FRAME DOES NOT OPERATE (CONT).		
<p>The diagram illustrates the operator's cab and the Load Handling System (LHS) of a vehicle. On the left, a detailed view of the cab interior shows the hydraulic selector switch, engine switch, and steering wheel (noted as removed for clarity). A joystick is also shown. On the right, an external view of the vehicle shows the LHS mechanism. A curved arrow points from the joystick in the cab to the LHS on the vehicle.</p>		
<p>Step 6. Operate LHS, check main frame for proper operation.</p> <p style="padding-left: 40px;">If main frame does not operate, fault not corrected. Notify supervisor.</p>		

Direct Support and General Support Maintenance (Cont)

5-7. DIRECT/GENERAL SUPPORT TROUBLESHOOTING PROCEDURES (CONT).

Table 5-2. Direct Support/General Support Troubleshooting (CONT)

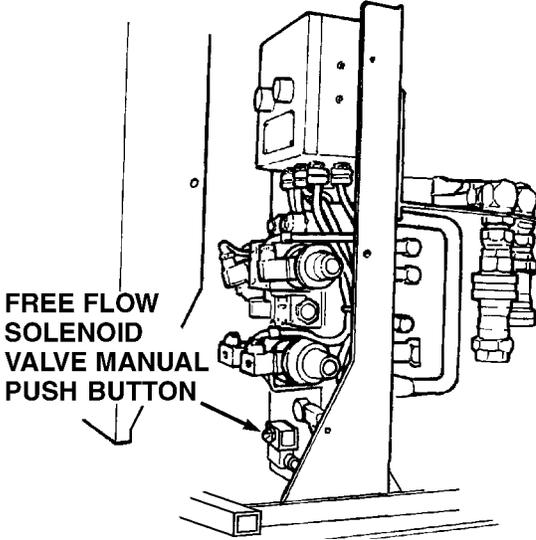
Malfunction	Test or Inspection	Corrective Action
LOAD HANDLING SYSTEM (LHS)		
9. LHS DOES NOT OPERATE OR OPERATES SLOWLY.		
		
NOTE		
Only remove center screw on engine side of LHS main junction box cover.		
Step 1.	Check operation of free flow solenoid valve manual push button.	<p>If manual push button cannot be pushed in, replace free flow solenoid valve (Para 5-34).</p> <p>If manual push button can be pushed in, go to Step 2. of this Fault.</p>
Step 2.	Check pressure at main manifold, port TPP, with LHS in transit position and joystick held in LOAD position.	<p>If pressure is less than 1,725 psi (11 894 kPa) adjust and replace main manifold relief valve (Para 5-33).</p>

Direct Support and General Support Maintenance (Cont)

Table 5-2. Direct Support/General Support Troubleshooting (CONT)

Malfunction	Test or Inspection	Corrective Action
LOAD HANDLING SYSTEM (LHS)		
9. LHS DOES NOT OPERATE OR OPERATES SLOWLY (CONT).		
Step 3. Check operation of LHS.		
If LHS does not operate or operates slowly, fault not corrected. Notify supervisor.		

Direct Support and General Support Maintenance (Cont)

5-7. DIRECT/GENERAL SUPPORT TROUBLESHOOTING PROCEDURES (CONT).

Table 5-2. Direct Support/General Support Troubleshooting (CONT)

Malfunction	Test or Inspection	Corrective Action
LOAD HANDLING SYSTEM (LHS)		
10. LOSS OF MAIN FRAME LOAD HOLDING.		
<p>The diagram illustrates the truck's load handling system (LHS) and its connection to the main frame. On the left, a close-up view of the operator's control panel shows the 'HYDRAULIC SELECTOR SWITCH' and the 'ENGINE SWITCH'. A line connects this panel to the main truck chassis. The truck is shown from a side-rear perspective, with the 'MAIN FRAME' extending from the chassis to the rear. At the rear, the 'LHS HOOK' is attached to a 'STEEL TUBE', which is supported by a 'JACK STAND' positioned under the truck's rear axle area.</p>		
<u>WARNING</u>		
All personnel must stand clear during lifting operations. A swinging or swaying load may cause injury or death to personnel.		
<u>NOTE</u>		
Lift truck only enough to lift truck's weight off suspension. Do not lift tires off the ground.		
Step 1.	Check operation of main frame. Will main frame hold a load from dropping in the direction of loading.	If main frame does not hold weight off vehicle suspension, go to Step 6. of this Fault.

Direct Support and General Support Maintenance (Cont)

Table 5-2. Direct Support/General Support Troubleshooting (CONT)

Malfunction	Test or Inspection	Corrective Action
LOAD HANDLING SYSTEM (LHS)		
10. LOSS OF MAIN FRAME LOAD HOLDING (CONT).		
<p>The diagram illustrates the hydraulic system components for the Load Handling System (LHS). On the left, a detailed view of the main manifold assembly is shown, including a pressure gage, a port TPT (Test Point), and a hose labeled 2917. On the right, a side view of the truck chassis is shown with the hook arm raised, indicating the system's application in a lifting operation.</p>		
<u>WARNING</u>		
<ul style="list-style-type: none"> • The LHS hydraulic system operates at oil pressures up to 1,725 psi (11 894 kPa). Never disconnect any hydraulic line or fitting without first dropping pressure to zero. Failure to comply may result in serious injury or death to personnel. • Fuel and oil are slippery and can cause falls. To avoid injury, wipe up spilled fuel or oil with rags. • All personnel must stand clear during lifting operations. A swinging or swaying load may cause injury or death to personnel. 		
Step 2.	Check pressure at TPT, with hose 2917 disconnected, hook arm up and main frame half way up and loaded.	If more than 0 psi (0 kPa) is present, replace LH (outboard) main frame cylinder manifold load control valve (Para 5-41).

Direct Support and General Support Maintenance (Cont)

5-7. DIRECT/GENERAL SUPPORT TROUBLESHOOTING PROCEDURES (CONT).

Table 5-2. Direct Support/General Support Troubleshooting (CONT)

Malfunction	Test or Inspection	Corrective Action
LOAD HANDLING SYSTEM (LHS)		
10. LOSS OF MAIN FRAME LOAD HOLDING (CONT).		
<p>The diagram illustrates the hydraulic testing setup. On the left, a truck is shown with a hose connected to its hydraulic system. A detailed view of the truck's hydraulic lines shows 'QUICK DISCONNECTS' and 'HOSE 2917'. On the right, a 'FLOWMETER' is connected to the 'IN' port of a 'LOAD VALVE'. The flowmeter is also connected to 'HOSE 2888', which leads to the 'LH MAIN CYLINDER MANIFOLD'. From the manifold, an 'ADAPTER HOSE' connects to 'PORT VA'. Another 'ADAPTER HOSE' connects to the 'OUT' port of the load valve. Labels include: QUICK DISCONNECTS, HOSE 2917, LH MAIN CYLINDER MANIFOLD, ADAPTER HOSE, PORT VA, HOSE 2888, ADAPTER HOSE, OUT, FLOWMETER, IN, and LOAD VALVE.</p>		
<u>WARNING</u>		
<ul style="list-style-type: none"> • The LHS hydraulic system operates at oil pressures up to 1,725 psi (11 894 kPa). Never disconnect any hydraulic line or fitting without first dropping pressure to zero. Failure to comply may result in serious injury or death to personnel. • Fuel and oil are slippery and can cause falls. To avoid injury, wipe up spilled fuel or oil with rags. 		
<u>NOTE</u>		
<ul style="list-style-type: none"> • Shut off engine (TM 9-2320-279-10) to connect flowmeter. • Hose 2917 is disconnected while installing and removing flowmeter. Hose 2917 must be connected during test. 		
Step 3.	Check flow at LH main manifold, port VA, with LHS in transit position while holding joystick in LOAD position.	
If more than 0 gpm (0 lpm) is present, replace LH main frame cylinder (Para 5-40).		

Direct Support and General Support Maintenance (Cont)

Table 5-2. Direct Support/General Support Troubleshooting (CONT)

Malfunction	Test or Inspection	Corrective Action
LOAD HANDLING SYSTEM (LHS)		
10. LOSS OF MAIN FRAME LOAD HOLDING (CONT).		
<u>WARNING</u>		
<ul style="list-style-type: none"> • The LHS hydraulic system operates at oil pressures up to 1,725 psi (11 894 kPa). Never disconnect any hydraulic line or fitting without first dropping pressure to zero. Failure to comply may result in serious injury or death to personnel. • Fuel and oil are slippery and can cause falls. To avoid injury, wipe up spilled fuel or oil with rags. 		
<u>NOTE</u>		
<ul style="list-style-type: none"> • Shut off engine (TM 9-2320-279-10) to connect flowmeter. • Hose 2917 is disconnected while installing and removing flowmeter. Hose 2917 must be connected during test. 		
Step 4.	Check flow at RH main manifold, port VA, with LHS in transit position while holding joystick in LOAD position.	
If more than 0 gpm (0 lpm) is present, replace RH main frame cylinder (Para 5-40).		

Direct Support and General Support Maintenance (Cont)

5-7. DIRECT/GENERAL SUPPORT TROUBLESHOOTING PROCEDURES (CONT).

Table 5-2. Direct Support/General Support Troubleshooting (CONT)

Malfunction	Test or Inspection	Corrective Action
LOAD HANDLING SYSTEM (LHS)		
10. LOSS OF MAIN FRAME LOAD HOLDING (CONT).		
<p>The diagram illustrates the truck's load handling system (LHS) and its controls. On the left, a close-up of the operator's station shows the HYDRAULIC SELECTOR SWITCH and the ENGINE SWITCH. On the right, a side view of the truck shows the HOOK ARM and LHS HOOK positioned over a 500 POUND LOAD.</p>		
<u>WARNING</u>		
All personnel must stand clear during lifting operations. A swinging or shifting load may cause injury or death to personnel.		
Step 5. Operate main frame. Will it hold a load from dropping in the direction of unloading.		
If main frame does not hold load, fault not corrected. Notify supervisor.		

Direct Support and General Support Maintenance (Cont)

Table 5-2. Direct Support/General Support Troubleshooting (CONT)

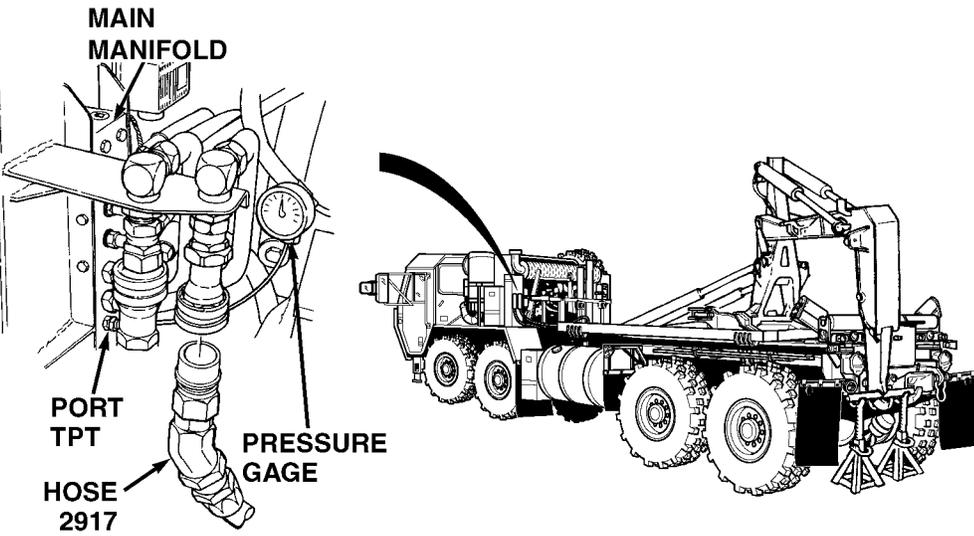
Malfunction	Test or Inspection	Corrective Action
LOAD HANDLING SYSTEM (LHS)		
10. LOSS OF MAIN FRAME LOAD HOLDING (CONT).		
		
<u>WARNING</u>		
<p>All personnel must stand clear during lifting operations. A swinging or shifting load may cause injury or death to personnel.</p>		
Step 6.	<p>Check pressure at TPT with hose 2917 disconnected and LHS raising truck enough to take truck weight off vehicle suspension.</p>	<p>If more than 0 psi (0 kPa) is present, replace RH (inboard) main frame cylinder load control valve (Para 5-41).</p>

Direct Support and General Support Maintenance (Cont)

5-7. DIRECT/GENERAL SUPPORT TROUBLESHOOTING PROCEDURES (CONT).

Table 5-2. Direct Support/General Support Troubleshooting (CONT)

Malfunction

Test or Inspection

Corrective Action

LOAD HANDLING SYSTEM (LHS)

10. LOSS OF MAIN FRAME LOAD HOLDING (CONT).

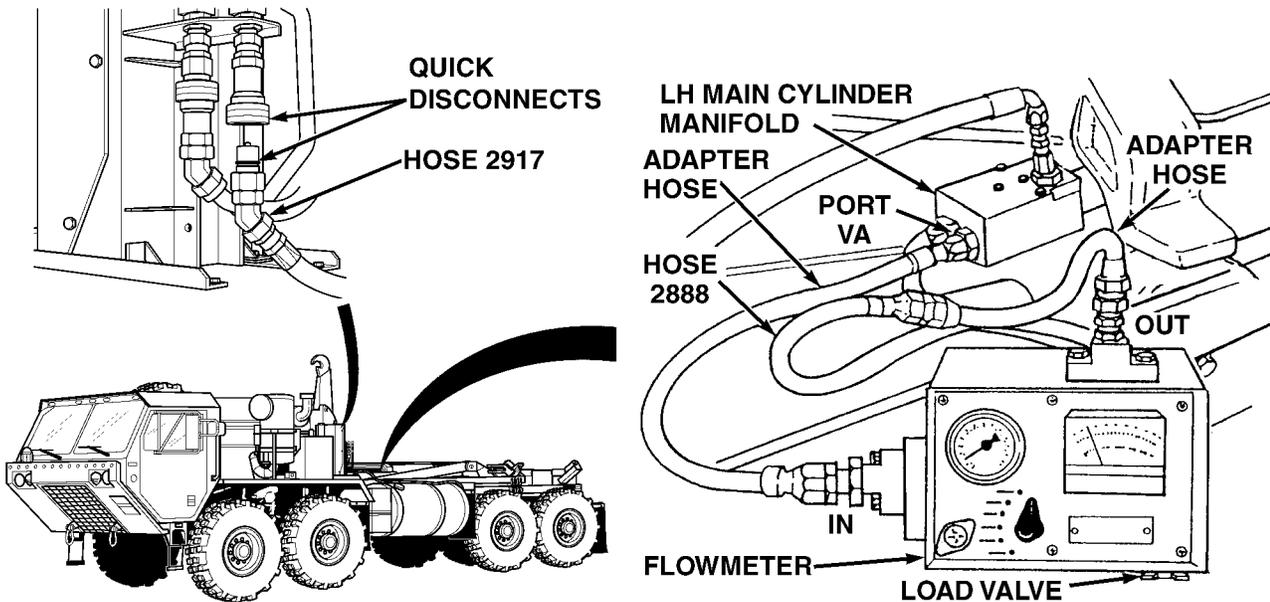

WARNING

- The LHS hydraulic system operates at oil pressures up to 1,725 psi (11 894 kPa). Never disconnect any hydraulic line or fitting without first dropping pressure to zero. Failure to comply may result in serious injury or death to personnel.
- Fuel and oil are slippery and can cause falls. To avoid injury, wipe up spilled fuel or oil with rags.

NOTE

- Shut off engine (TM 9-2320-279-10) to connect flowmeter.
- Hose 2917 is disconnected while installing and removing flowmeter. Hose 2917 must be connected during test.

Step 7. Check flow at LH main frame cylinder manifold, port VB, with main frame down completely while holding joystick in LOAD position.

If more than 0 gpm (0 lpm) is present, replace LH main frame cylinder (Para 5-40).

Direct Support and General Support Maintenance (Cont)

Table 5-2. Direct Support/General Support Troubleshooting (CONT)

Malfunction	Test or Inspection	Corrective Action
LOAD HANDLING SYSTEM (LHS)		
10. LOSS OF MAIN FRAME LOAD HOLDING (CONT).		
WARNING		
<ul style="list-style-type: none"> • The LHS hydraulic system operates at oil pressures up to 1,725 psi (11 894 kPa). Never disconnect any hydraulic line or fitting without first dropping pressure to zero. Failure to comply may result in serious injury or death to personnel. • Fuel and oil are slippery and can cause falls. To avoid injury, wipe up spilled fuel or oil with rags. 		
NOTE		
<ul style="list-style-type: none"> • Shut off engine (TM 9-2320-279-10) to connect flowmeter. • Hose 2917 is disconnected while installing and removing flowmeter. Hose 2917 must be connected during test. 		
Step 8.	Check flow at RH main frame cylinder manifold, port VA, with main frame down completely while holding joystick in LOAD position.	
	If more than 0 gpm (0 lpm) is measured, replace RH main frame cylinder (Para 5-40).	
	If 0 gpm (0 lpm) is measured, replace load control valve (Para 5-41).	

Direct Support and General Support Maintenance (Cont)

5-7. DIRECT/GENERAL SUPPORT TROUBLESHOOTING PROCEDURES (CONT).

Table 5-2. Direct Support/General Support Troubleshooting (CONT)

Malfunction	Test or Inspection	Corrective Action
LOAD HANDLING SYSTEM (LHS)		
10. LOSS OF MAIN FRAME LOAD HOLDING (CONT).		
<p>The diagram illustrates the truck's load handling system (LHS) and its control interface. On the left, a close-up view of the operator's control panel shows the 'HYDRAULIC SELECTOR SWITCH' and the 'ENGINE SWITCH'. On the right, a side view of the truck shows the 'MAIN FRAME' extending from the chassis, supporting an 'LHS HOOK' and a 'STEEL TUBE'. A 'JACK STAND' is positioned under the steel tube to support the load. Arrows point from the labels to the corresponding parts in the diagram.</p>		
<u>WARNING</u>		
<p>All personnel must stand clear during lifting operations. A swinging or shifting load may cause injury or death to personnel.</p>		
Step 9.	Check operation of main frame in the direction of loading.	<p>If main frame does not hold weight off vehicle suspension, fault not corrected. Notify supervisor.</p>

Direct Support and General Support Maintenance (Cont)

Table 5-2. Direct Support/General Support Troubleshooting (CONT)

Malfunction	Test or Inspection	Corrective Action
LOAD HANDLING SYSTEM (LHS)		
11. LHS HOOK ARM DISENGAGES FROM FLATRACK WHILE UNLOADING.		
NOTE		
The 1/8 in. (3.175 mm) measurement is for the bottom of the hook bar only.		
Step 1. Check hook bar wear.		
If wear at lower back side of hook bar is greater than 1/4 in. (6.35 mm) or greater than 1/8 in. (3.175 mm) at bottom of hook bar, repair flatrack hook bar. Refer to TM 9-3990-206-14&P and go to Step 3. of this Fault.		

Direct Support and General Support Maintenance (Cont)

5-7. DIRECT/GENERAL SUPPORT TROUBLESHOOTING PROCEDURES (CONT).

Table 5-2. Direct Support/General Support Troubleshooting (CONT)

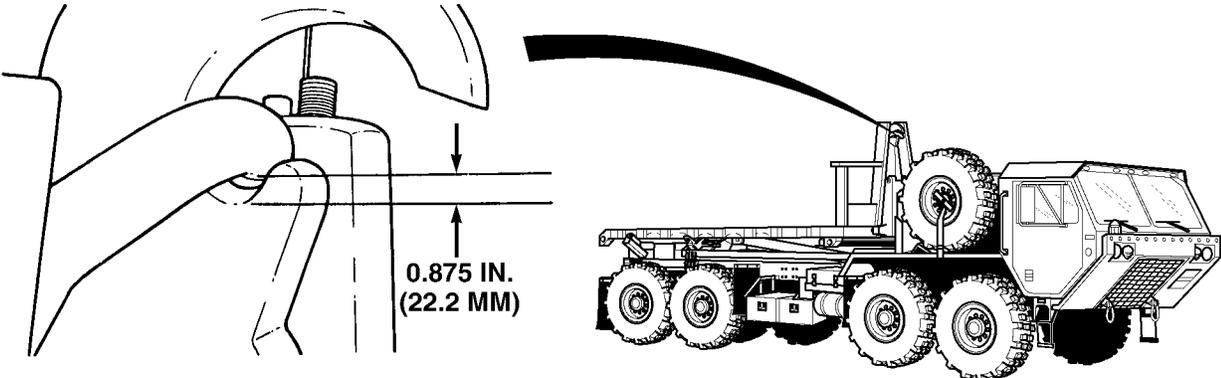
Malfunction	Test or Inspection	Corrective Action
LOAD HANDLING SYSTEM (LHS)		
11. LHS HOOK ARM DISENGAGES FROM FLATRACK WHILE UNLOADING (CONT).		
		
NOTE		
Clearance given is for a hook bar with or without any wear.		
Step 2. Check clearance between LHS hook arm and flatrack hook bar.		
If clearance is less than 0.875 in. (22.2 mm), fault not corrected. Notify supervisor.		
If clearance is greater than 0.875 in. (22.2 mm) go to Step 3. of this Fault.		

Direct Support and General Support Maintenance (Cont)

Table 5-2. Direct Support/General Support Troubleshooting (CONT)

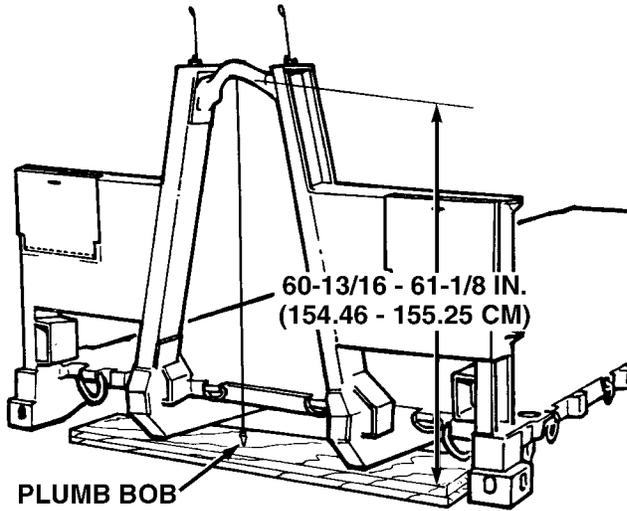
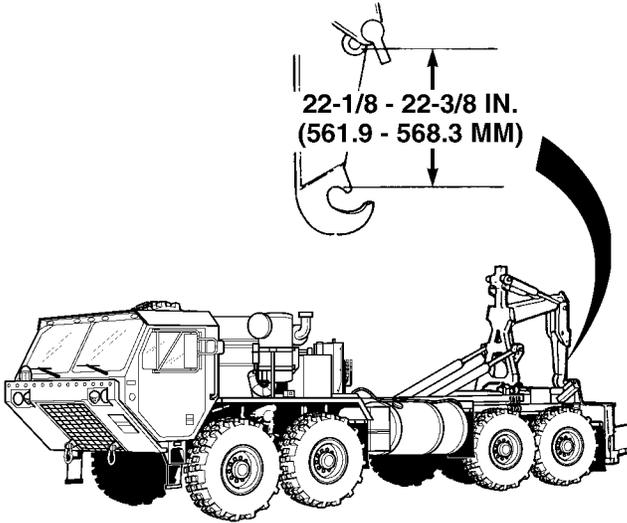
Malfunction	Test or Inspection	Corrective Action
LOAD HANDLING SYSTEM (LHS)		
11. LHS HOOK ARM DISENGAGES FROM FLATRACK WHILE UNLOADING (CONT).		
		
NOTE		
<ul style="list-style-type: none"> • Four (4) 2" x 12" x 6' boards are used under the front and rear of the flatrack to ensure the main rails will be at the same height. • Front boards will be used to aid in measuring the flatrack hook bar height. • Use of a level (3 ft. minimum [92 cm]) is required when leveling flatrack. • Flatrack hook bar height range is given for a hook bar with or without wear. • If lift hook does not swing toward truck, push lift hook toward truck and insert pin to hold in measurement position. 		
Step 3.	Level flatrack, check flatrack hook bar height.	
<p style="padding-left: 40px;">If measurement is not between 60-13/16 and 61-1/8 in. (154.469 and 155.25 cm), repair flatrack hook bar. Refer to TM 9-3990-206-14&P.</p>		
Step 4.	Remove quick pin and pin from hook, allow hook to swing toward truck. Check hook arm length.	
<p style="padding-left: 40px;">If hook arm measurement is not between 22-1/8 and 22-3/8 in. (561.9 to 568.3 mm), replace hook arm. Refer to Para 5-22.</p>		
Step 5.	Operate LHS and check for proper unload function.	
<p style="padding-left: 40px;">If flatrack does not unload correctly, fault not corrected. Notify supervisor.</p>		

Direct Support and General Support Maintenance (Cont)

Section IV. Direct Support/General Support Maintenance Introduction

5-8. LOAD HANDLING SYSTEM (LHS) MAINTENANCE INTRODUCTION.

This section contains maintenance instructions for repairing, replacing, installing, and servicing the Load Handling System (LHS) components as authorized by the Maintenance Allocation Chart (MAC) at the Direct Support Maintenance level.

5-9. GENERAL REMOVAL INSTRUCTIONS.

a. Work Required. Remove parts if repair or replacement is required. Do not disassemble a component any further than needed.

b. Preparation. Before removal of any electrical, hydraulic, or component ensure system component is not energized or pressurized. Disconnect battery ground cable. Relieve hydraulic system pressure. Before removal of fasteners (nuts, locknut) remove any paint on threads to prevent binding of fastener.

c. Identification. To ease assembly and installation, tag and mark shims, connectors, wires, and mating ends of lines before disconnecting them. Identify similar parts to ensure correct assembly.

5-10. GENERAL DISASSEMBLY INSTRUCTIONS.

CAUTION

Self-locking fasteners that are loosened must be replaced, not tightened.

a. Cleanliness. Work area must be as clean as possible to prevent contamination to components.

b. Locking Parts. Replace all lockwashers, cotter pins, and locknuts at time of reassembly.

c. Expendable Parts. All gaskets, packings, and seals removed during repair must be discarded and replaced with new parts.

d. Removing Seals. Be sure all traces of oil, gaskets, and sealants are removed from components. When possible, use wood or plastic probes and scrapers to prevent damage to machined surfaces.

CAUTION

Do not use tape to close off oil openings. Sticky surface of tape can mix with oil and cause hydraulic system malfunctions.

e. Parts Protection. To keep dust, dirt, moisture, and other objects out of internal parts of systems, or components, cap or tape over all open tubes, hoses, fittings, air lines, and component openings as soon as part is removed. Wrap all removed parts in clean paper or dip parts in preservation oil.

Direct Support and General Support Maintenance (Cont)

WARNING

- Drycleaning solvent (P-D-680) is TOXIC and flammable. Wear protective goggles, face shield, and gloves; use only in a well-ventilated area; avoid contact with skin, eyes, and clothes; and do not breathe vapors. Keep away from heat or flame. Never smoke when using solvent. The flashpoint for Type III Drycleaning Solvent is 200°F (93°C). Failure to do so may result in injury or death to personnel.
- If personnel become dizzy while using cleaning solvent, immediately get fresh air and medical help. If solvent contacts skin or clothes, flush with cold water. If solvent contacts eyes, immediately flush eyes with water and get immediate medical attention.
- Never use fuel to clean parts. Fuel is highly flammable. Serious injury to personnel could result if fuel ignites during cleaning.

f. Cleaning Solvents. Use only approved cleaning solvents to clean parts. Drycleaning solvent, P-D-680 (Item 18, Appendix F), is commonly used. Always work in a well-ventilated area.

WARNING

Compressed air used for cleaning purposes will not exceed 30 psi (207 kPa). Use only with effective chip guarding and personal protective equipment (goggles/shield, gloves, etc.). Failure to comply may result in injury to personnel.

g. Removing Deposits. Soak parts in drycleaning solvent and wash away deposits by flushing or spraying. When necessary, brush with a soft bristle brush (not wire) moistened in solvent. Use compressed air to dry parts, except bearings, after cleaning. Bearings must drip and air dry.

h. Tools. Do not use wire brushes, abrasive wheels, or compounds to clean parts unless specifically approved in the detailed procedures. Parts may be scratched or altered, and may weaken a highly stressed part.

CAUTION

Do not clean lubricant seals, rubber hoses, or electrical components with solvent.

i. Rubber Parts. Do not clean preformed packings or rubber parts in drycleaning solvent. Wipe parts clean with a dry, lint-free cloth.

5-11. GENERAL CLEANING INSTRUCTIONS.

WARNING

Environmental friendly high pressure washing creates hazardous noise levels and severe burn potential. Eye, skin, and ear protection is required. Failure to comply may result in injury to personnel.

a. Exterior Parts. Pressure wash all exterior parts thoroughly before removing. This will make inspection and disassembly easier.

Direct Support and General Support Maintenance (Cont)

5-11. GENERAL CLEANING INSTRUCTIONS (CONT).

WARNING

Solvents used with a spray gun must be used in a spray booth with a filter. Face shield must be used by personnel operating spray gun. Failure to comply may result in injury to personnel.

b. LHS Assembly. Use a spray gun and solvent for cleaning exterior of LHS assembly. Allow solvent to remain on item surface for 10 minutes before rinsing. Rinse with hot water under 80 to 120 pounds of pressure if available. An ordinary garden hose with nozzle may be used if other equipment is not available. Rinse thoroughly.

WARNING

To prevent corrosion, parts should be dipped in rust preventive within two hours of degreasing.

c. Degreasing Machine. A degreasing machine may be used to remove heavy grease and oil from metal parts.

d. Passages. After degreasing, check all oil passages and cavities for dirt or blockage before coating with rust preventive. Run a thin, flexible wire through oil passages to make sure they are not clogged. Use a pressure spray gun and drycleaning solvent to clean dirty passages.

e. Electrical Parts. Electrical parts; such as coils, junction blocks, and switches, should not be soaked or sprayed with cleaning solutions. Clean these parts with a clean, lint-free cloth moistened with drycleaning solvent.

WARNING

- Drycleaning solvent (P-D-680) is TOXIC and flammable. Wear protective goggles, face shield, and gloves; use only in a well-ventilated area; avoid contact with skin, eyes, and clothes and do not breathe vapors. Keep away from heat or flame. Never smoke when using solvent. The flashpoint for Type III Drycleaning Solvent is 200°F (93°C). Failure to do so may result in injury or death to personnel.
- If personnel become dizzy while using cleaning solvent, immediately get fresh air and medical help. If solvent contacts skin or clothes, flush with cold water. If solvent contacts eyes, immediately flush eyes with water and get immediate medical attention.

CAUTION

- Never use gasoline or other petroleum based products to clean or preserve hydraulic system parts.

f. Hydraulic System. When cleaning hydraulic system parts use drycleaning solvent, P-D-680. Clean and dry parts thoroughly to make sure no residue remains. If a coating preservative is required before assembly, apply a light film of preservative oil. If petroleum-free solvents are not available, use the same hydraulic fluid as used in the truck's hydraulic system.

Direct Support and General Support Maintenance (Cont)

5-12. GENERAL INSPECTION INSTRUCTIONS.

- a. Cleaning.** Clean all parts before inspection. Check for defects such as physical distortion, wear, cracks, and pitting.
- b. Sealing Surfaces.** Inspect all surfaces in contact with gaskets, packings, or seals for nicks and burrs. If any defect is found, remove it before assembly.
- c. Tubing, Hoses, and Fittings.** Inspect all hose surfaces for broken or frayed fabric. Check for breaks caused by sharp kinks or contact with other parts of the truck. Inspect fittings, tubing, mating surfaces, and threads for nicks, cracks, scratches, and other damage. Replace any defective part. After assembly and during initial truck operation periods, check for leaks.
- d. Electrical Parts.** Inspect all wiring harnesses for broken, chafed, or burned wiring. Inspect all terminal connectors for loose connections and broken parts.
- e. Metal Parts.** Visually inspect all castings and weldments for cracks. Parts that carry a great load should receive magnetic particle inspection. Critical non-ferrous parts may be inspected with fluorescent penetrant.

5-13. GENERAL REPAIR INSTRUCTIONS.

- a. Exterior Parts.** Chassis and exterior painted parts may be resurfaced when paint is damaged or where parts have been repaired.

NOTE

Polished or machined steel parts not protected by cadmium, tin, copper, or other plating or surface treatments require protection. Bare metal surfaces must be free of moisture when protective coating is applied.

- b. Protecting Parts.** Protect bare steel surfaces from rust when not actually undergoing repair work. Dip parts in, or spray them with, corrosion preventive compound. Aluminum parts may require protection in atmospheres having a high salt content.
- c. Screws, Nuts, and Fittings.** Replace any screw, nut, or fitting with damaged threads. Inspect tapped holes for thread damage. If cross-threading is evident, retap the hole for the next oversize screw or stud. If the retapping will weaken the part, or if the cost of the part makes retapping impractical, replace the part. Chasing the threads with proper size tap or die may be adequate.
- d. Stud Installation.** When installing studs, use a proper driver. A worn stud driver may damage the end thread. Then a chasing die must be used before a nut can be screwed on. This procedure will remove cadmium plating and allow corrosion. Before installing a stud, inspect the hole for chips. Blow out foreign matter and start stud by hand. Before final insertion, coat thread with a film of antiseize compound. Install stud to proper "setting height," which is the total projecting length.
- e. Dents.** Straighten minor body dents by bumping with a soft-faced hammer while using a wooden block backing.
- f. Sheet Metal Repair.** Repair minor skin cracks by installing patches.

Direct Support and General Support Maintenance (Cont)

5-14. GENERAL ASSEMBLY INSTRUCTIONS.

a. Preparation. Remove protective grease coatings from new parts before installation.

b. Preformed Packing Installation. Lubricate all preformed packings with a thin coat of light mineral oil before installing. To install a preformed packing, first clean the groove, then stretch packing and place into position. Place component on flat surface and uniformly press packing into position. Ensure preformed packings are not nicked or torn during assembly.

CAUTION

Use sealing compound sparingly and only on male threads. Do not apply compound on first two threads to avoid contamination of system from compound. Do not apply compound to hose connections or fittings with preformed packings. Damage to equipment may result.

c. Pipe Joints and Fittings. Use sealing compound sealant or adhesive as indicated in each maintenance task. Refer to Para 5-15 for general tightening procedure.

d. Oil Seals. Coat oil seals evenly with oil or grease before installing. Install oil seals with seal lip facing toward lubricant, applying an even force to outer edge of seal. If oil seals are to be installed over keyed or splined shafts, use a guide to prevent sharp edge of keyway or splines from cutting the leather or neoprene seal. Construct guides of very thin gage sheet metal and shape to the required diameter. Make certain guide edges are not sharp and are bent slightly inward so they do not cut the seal.

WARNING

On direct contact, uncured silicone sealant irritates eyes. In case of contact, flush eyes with water and seek medical attention. In case of skin contact, wipe off and flush with water.

e. Silicone Sealant. Silicone sealant is often used instead of a gasket to seal mating parts. The mating parts must be clean, dry, and free of oil or grease for proper adhesion. After silicone sealant has been applied, the mating parts must be assembled immediately. Silicone sealant starts to set-up in 15 minutes and takes 24 hours to completely set. Excess silicone sealant should be wiped off after assembling the mating parts.

f. Gaskets. Remove all traces of previous gasket and sealant before installing new gasket. Coat both sides of gasket with sealant to provide added sealing.

Direct Support and General Support Maintenance (Cont)

5-15. GENERAL INSTALLATION INSTRUCTIONS.

a. Preparation. When unpacking items, remove all packing material, barrier paper, tape, plastic bags, protective caps, and protective grease coatings. Handle and store removed components carefully.

CAUTION

Use sealing compound sparingly and only on male threads. Do not apply compound on first two threads to avoid contamination of system from compound. Do not apply compound to hose connections or fittings with preformed packings. Damage to equipment may result.

b. Sealing Compounds. Use sealing compounds as required in each maintenance task.

c. Torquing. Tighten bolts, screws, washers, hoses, and fittings as required in Appendix J or in each maintenance task.

d. Identification Tags. Put hoses, tubes, lines, and electrical wiring in place by matching identification tags and markings on equipment.

e. Hoses and Wiring. After installing hoses and wiring ensure that they do not contact moving part or component edges. Secure in place, out of way with cable ties and cushion clips.

f. Hose and Fitting Tightening Procedure.**NOTE**

Tighten hoses and fittings as required in Appendix J or in each maintenance task. If a torque wrench and crow'sfoot are not available or cannot be used, use the following procedure.

- (1) Install hose nut (1) on fitting (2).

NOTE

When turning effort increases, hose nut seat is in contact with adapter seat.

- (2) Tighten hose nut (1) until seated on fitting (2).

NOTE

Alignment marks allow the mechanic to count the number of flats the hose nut has rotated during tightening.

- (3) Scribe alignment mark on hose nut (1) and fitting (2).
- (4) Tighten hose nut (1) until mark on hose nut has rotated correct number of flats (Refer to Table 5-3).

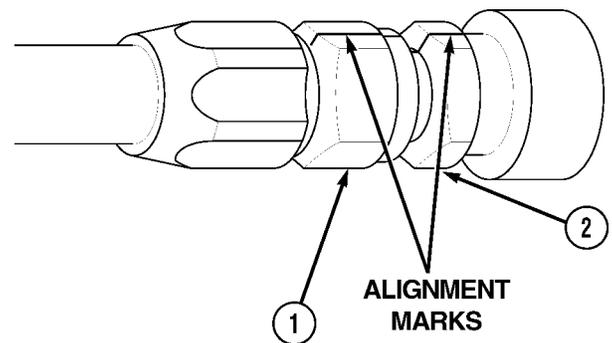

Direct Support and General Support Maintenance (Cont)

5-15. GENERAL ASSEMBLY INSTRUCTIONS (CONT).

Table 5-3. Recommended Flats Rotation.

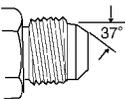
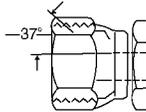
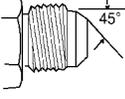
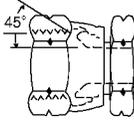
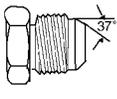
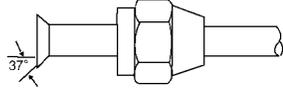
						
	MALE HALF	FEMALE HALF	MALE HALF	FEMALE HALF	MALE HALF	FEMALE HALF
Dash No.	JIC 37 Degree Flared Hose and Fitting Machined Seat		SAE 45 Degree Flared Hose and Fitting Machined Seat		JIC 37 Degree Flared Tube	
-4	1 1/2 - 1 3/4		1 - 1 1/4		2 1/4 - 2 3/4	
-5	1 - 1 1/2		1 - 1 1/4		2 1/4 - 2 3/4	
-6	1 - 1 1/2		3/4 - 1		2 1/4 - 2 3/4	
-8	1 1/4 - 1 3/4		1 - 1 1/4		2 1/4 - 2 3/4	
-10	1 1/4 - 1 3/4		1 - 1 1/4		2 - 2 1/2	
-12	1 - 1 1/2		1 - 1 1/4		2 - 2 1/2	
-16	3/4 - 1		-----		2 1/4 - 2 3/4	
-20	1/2 - 3/4		-----		1 1/4 - 2 3/4	
-24	1/2 - 3/4		-----		3/4 - 1 1/4	
-32	3/4		-----		1 - 1 1/4	

g. Pipe Thread Tightening Procedures.

WARNING

Adhesives, solvents, and sealing compounds can burn easily, can give off harmful vapors and are harmful to skin and clothing. To avoid injury or death, keep away from open fire and use in a well-ventilated area. If adhesive, solvent, or sealing compound gets on skin or clothing, wash immediately with soap and water.

CAUTION

Use sealing compound sparingly and only on male threads. Do not apply compound on first two threads to avoid contamination of system from compound. Do not apply compound to hose connections or fittings with preformed packings. Damage to equipment may result.

- (1) Coat threads of male fitting with sealing compound, sealant, or adhesive as indicated in each maintenance task.
- (2) Position male fitting on female fitting finger-tight.
- (3) Scribe alignment mark on both fittings.

CAUTION

- It may be necessary to tighten fitting slightly more or less than 2 1/2 turns to match position noted prior to removal. Do not loosen fitting to arrive at proper position or a leak may occur.
 - Over-tightening may cause pipe fitting to deform and damage to the joining fitting, flange or component.
- (4) Tighten male fitting 2 1/2 (3 maximum) full turns past hand-tight position.

Direct Support and General Support Maintenance (Cont)

h. Fastener Tightening Sequence Procedures.

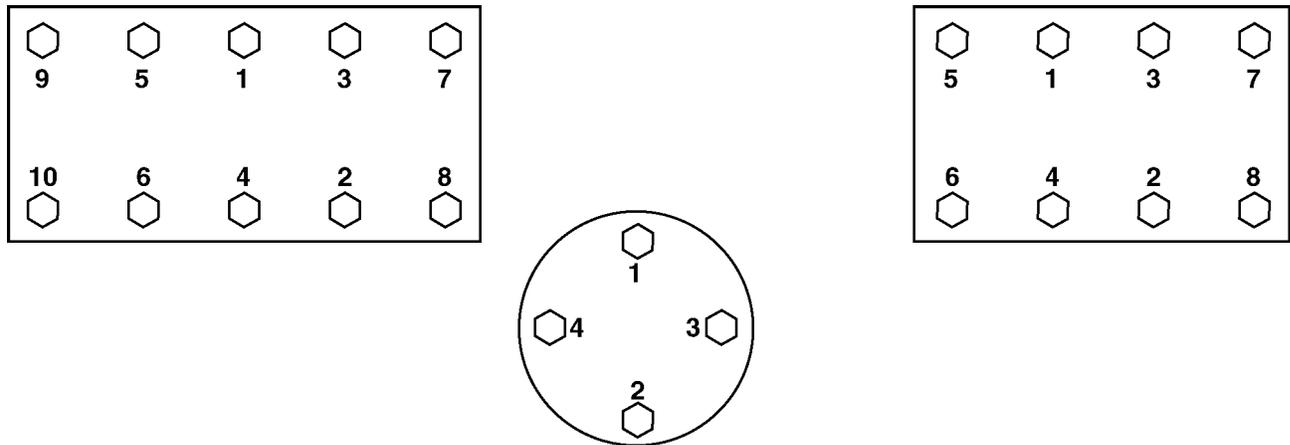

Figure 5-1. General Tightening Sequences.

NOTE

If a component has a critical tightening sequence it will be illustrated in that particular task; otherwise, use the general sequence charts provided (Figure 5-1).

- (1) Installation Torque.
 - (a) Tighten nuts twice in a criss-cross pattern using a torque wrench. The first time nut is torqued apply approximately 75 percent of the final torque value.
 - (b) Repeat the sequence a second time until 100 percent of the final torque value has been obtained for each nut.
- (2) Checking Torque.

NOTE

When one or more screws are loose, check torque for all bolts on the component.

- (3) Tighten nuts in a criss-cross pattern using a torque wrench. Apply 100 percent of the final torque value.

5-16. PREPARATION FOR STORAGE OR SHIPMENT INTRODUCTION.

Refer to (TM 9-2320-279-20) for introduction to preparation for storage and shipment.

5-17. PREPARATION FOR STORAGE OR SHIPMENT.

Refer to (TM 9-2320-279-20) for preparation for storage and shipment.

5-18. STORAGE MAINTENANCE PROCEDURES.

Refer to (TM 9-2320-279-20) for preparation for storage and shipment.

Direct Support and General Support Maintenance (Cont)

Section V. Direct Support/General Support Maintenance Procedures

5-19. LOADING HANDLING SYSTEM (LHS) MAIN WIRE HARNESS REPLACEMENT.										
This task covers:										
a. Removal	b. Installation	c. Follow-on Maintenance								
INITIAL SETUP										
<i>Models</i> M1120	<i>Personnel Required</i> MOS 63W, Wheel vehicle repairer (2)									
<i>Test Equipment</i> None	<i>References</i> None									
<i>Special Tools</i> Tool Kit, General Mechanic's, Item 32, Appendix B Tool Kit, Electric, Item 31, Appendix B Lifting Device, Minimum Capacity 2500 lbs. (1135 kg) Wooden Block (2), Appendix H	<i>Equipment Condition</i> <table border="0"> <tr> <td><i>TM or Para</i></td> <td><i>Condition Description</i></td> </tr> <tr> <td>TM 9-2320-279-10</td> <td>Engine OFF</td> </tr> <tr> <td>TM 9-2320-279-10</td> <td>Wheels chocked</td> </tr> <tr> <td>Para 2-9</td> <td>Hydraulic selector switch in OFF position</td> </tr> </table>		<i>TM or Para</i>	<i>Condition Description</i>	TM 9-2320-279-10	Engine OFF	TM 9-2320-279-10	Wheels chocked	Para 2-9	Hydraulic selector switch in OFF position
<i>TM or Para</i>	<i>Condition Description</i>									
TM 9-2320-279-10	Engine OFF									
TM 9-2320-279-10	Wheels chocked									
Para 2-9	Hydraulic selector switch in OFF position									
<i>Supplies</i> Cable Ties, Item 4, Appendix F Sealing Compound, Item 17, Appendix F Tape, Electrical, Item 20, Appendix F Locknut (4), Item 6, Appendix K Lockwasher (4), Item 16, Appendix K	<i>Special Environmental Conditions</i> None									
	<i>General Safety Instructions</i> None									

Direct Support and General Support Maintenance (Cont)

a. Removal.

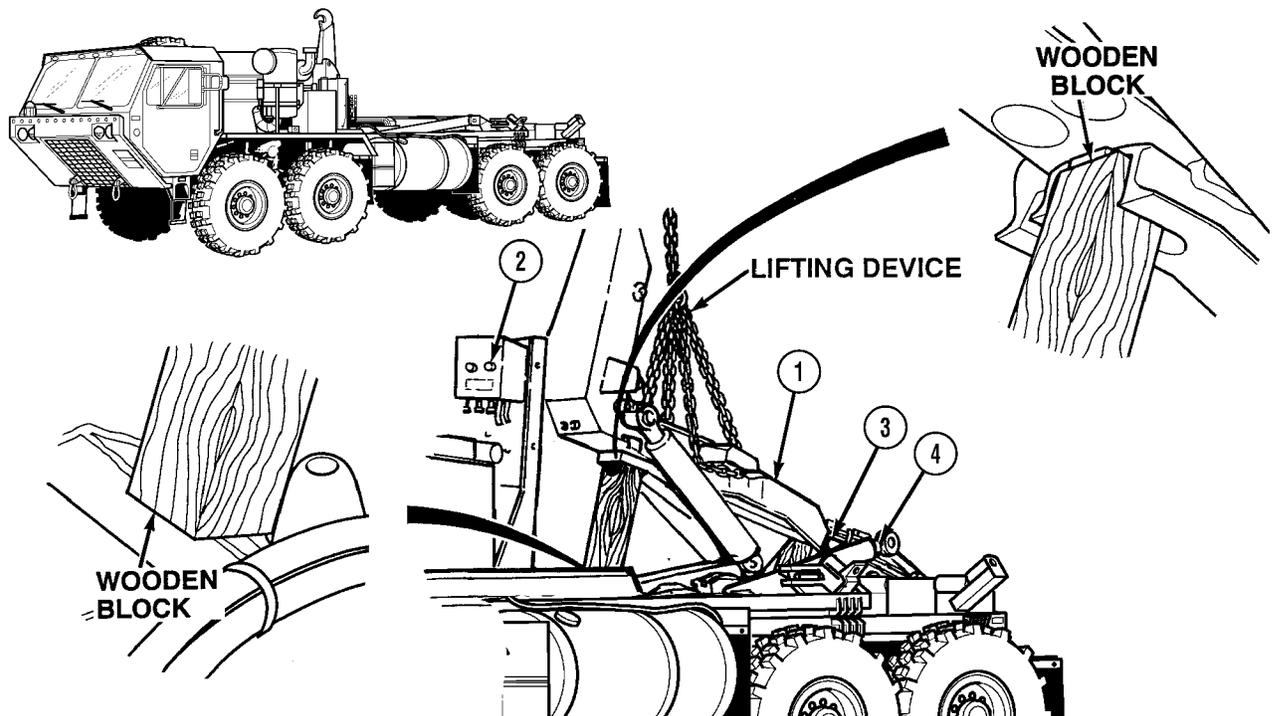
**WARNING**

Main frame weighs 2,500 lbs. (1 135 kg). Attach suitable lifting device prior to removal to prevent possible injury to personnel

- (1) Attach lifting device to main frame (1).
- (2) Turn ENGINE switch to ON position.
- (3) With the aid of an assistant, push safe lowering button (2) while using lifting device to lift main frame (1) until hook arm pivot pin (3) is above main cylinder (4).
- (4) Turn ENGINE switch to OFF position.
- (5) Block main frame (1) up in two places with wooden blocks and remove lifting device from main frame (1).

Direct Support and General Support Maintenance (Cont)

5-19. LOAD HANDLING SYSTEM (LHS) MAIN WIRE HARNESS REPLACEMENT (CONT).

- (6) Disconnect LHS main wire harness connector (5) from LHS junction box (6) at MC87 connector.

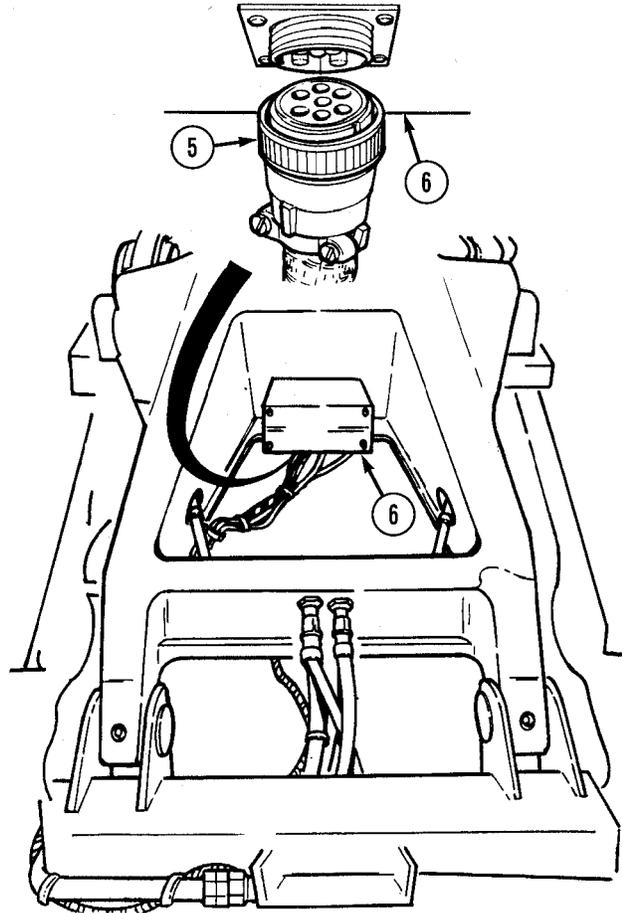

NOTE

Tag all wires prior to removal.

- (7) Loosen two screws (7) and remove nut (8) from LHS main wire harness connector (5).
- (8) Remove seven wires (9) with terminals (10) from LHS main wire harness connector (5) and tape wires together using electrical tape.

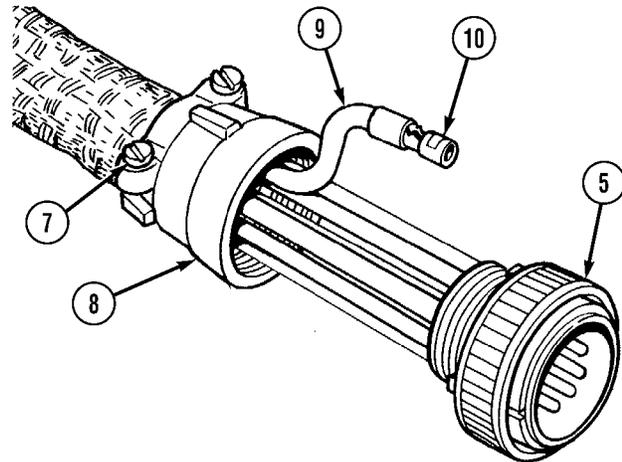

Direct Support and General Support Maintenance (Cont)

- (9) Remove LHS main wire harness (11) from main frame tubes (12), hoses (13), and left compression frame tube (14) where attached with cable ties.

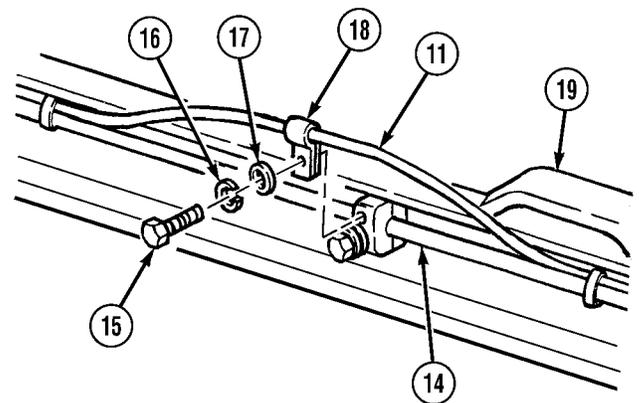
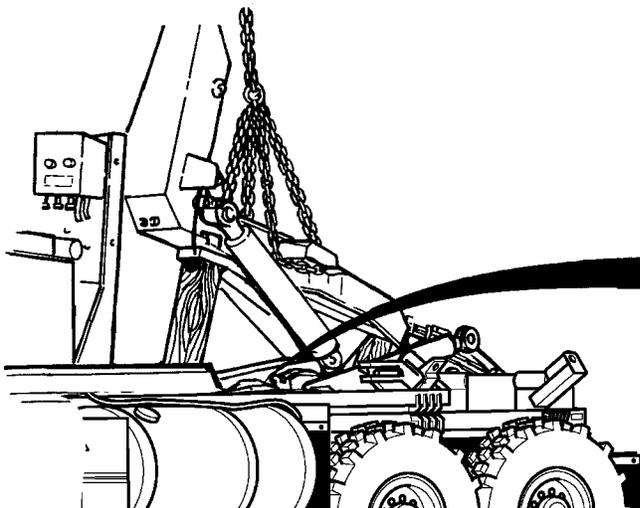
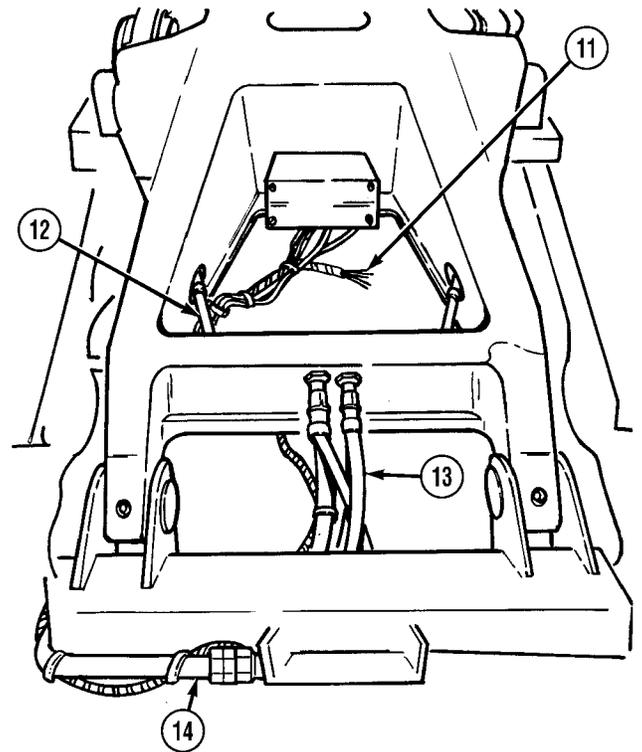

- (10) Remove four screws (15), four lockwashers (16), four washers (17), four cushion clips (18), and LHS main wire harness (11) from compression frame tube (14) at inside of left compression frame rail (19). Discard lockwashers.

Direct Support and General Support Maintenance (Cont)

5-19. LOAD HANDLING SYSTEM (LHS) MAIN WIRE HARNESS REPLACEMENT (CONT).

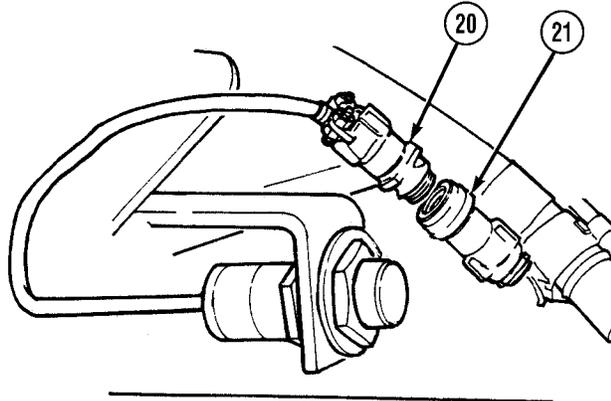
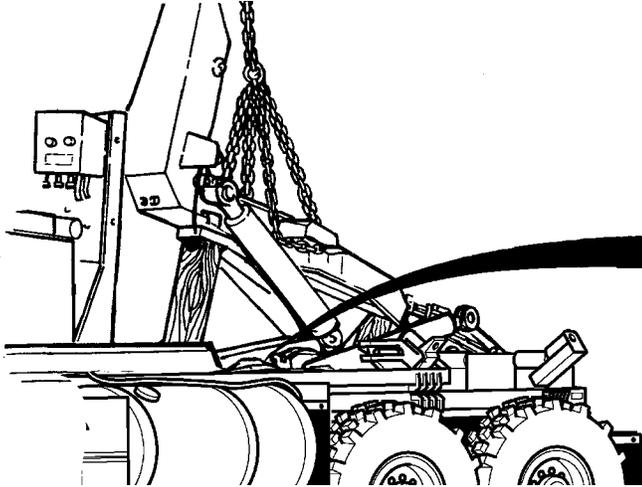

(11) Disconnect proximity switch (hook arm down) connector (20) from MC88 connector (21).

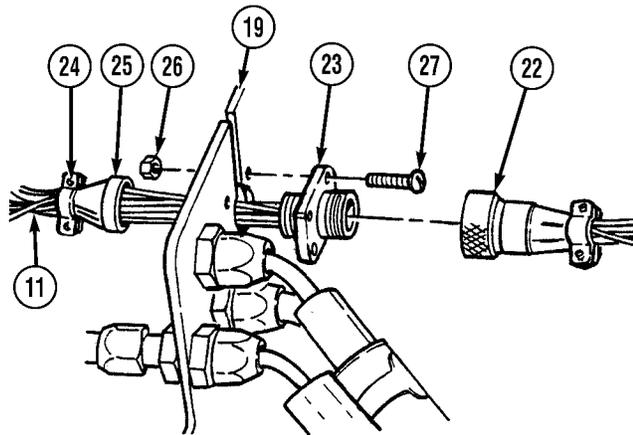
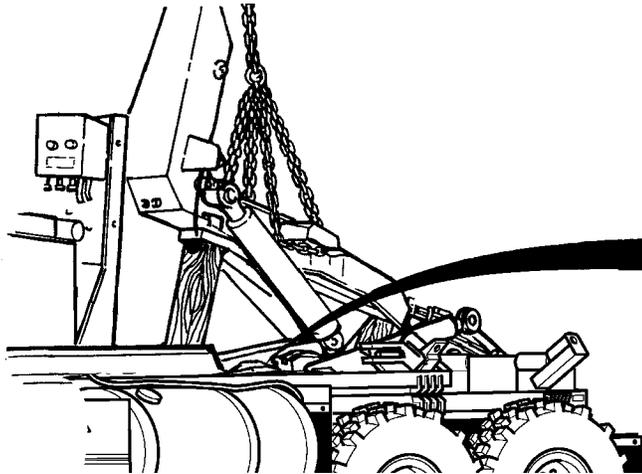

- (12) Remove MC86 connector (22) from bulkhead connector (23).
- (13) Loosen two screws (24) and remove nut (25) from bulkhead connector (23).
- (14) Remove four locknuts (26) and screws (27) from bulkhead connector (23) and compression frame (19). Discard locknuts.
- (15) Lift bulkhead connector (23) up through slot in compression frame (19) and remove LHS main wire harness (11) from truck.

Direct Support and General Support Maintenance (Cont)

b. Installation.

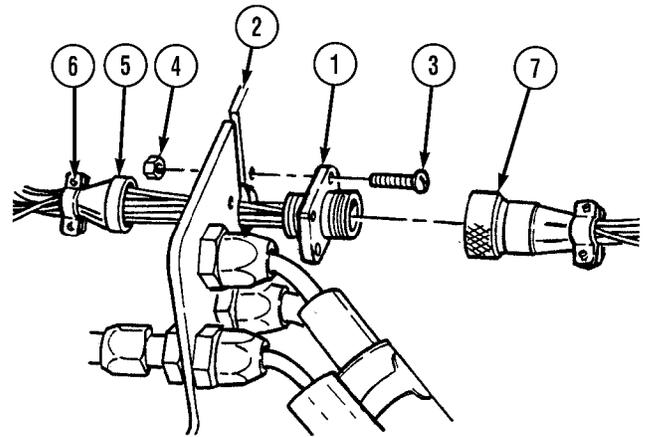
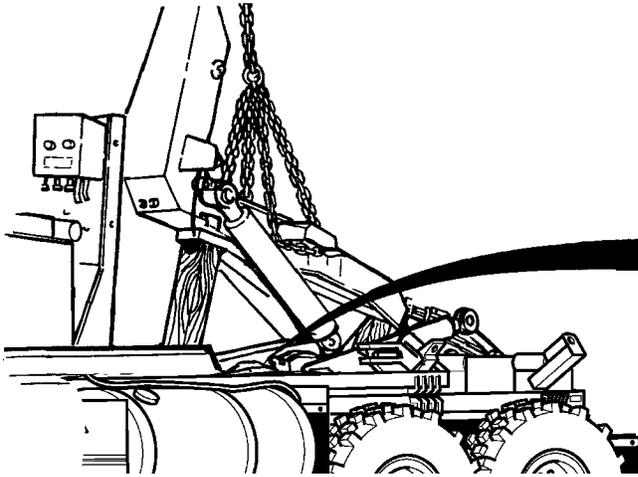

- (1) Install bulkhead connector (1) in compression frame (2) with four screws (3) and locknuts (4).
- (2) Install nut (5) on bulkhead connector (1) and tighten two screws (6).
- (3) Install connector (7) on bulkhead connector (1).

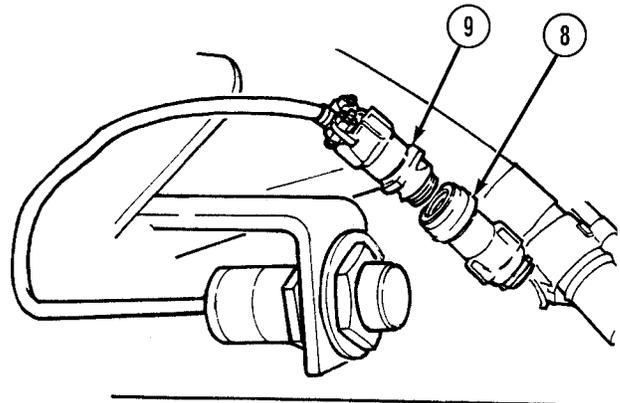
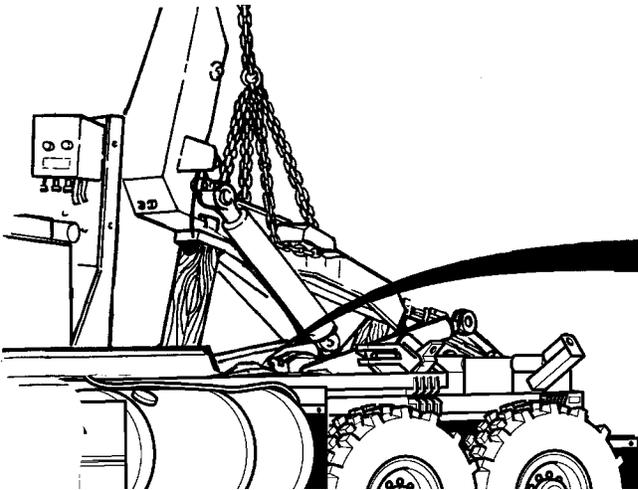

- (4) Connect MC88 connector (8) to proximity switch (hook arm down) connector (9).

Direct Support and General Support Maintenance (Cont)

5-19. LOAD HANDLING SYSTEM (LHS) MAIN WIRE HARNESS REPLACEMENT (CONT).

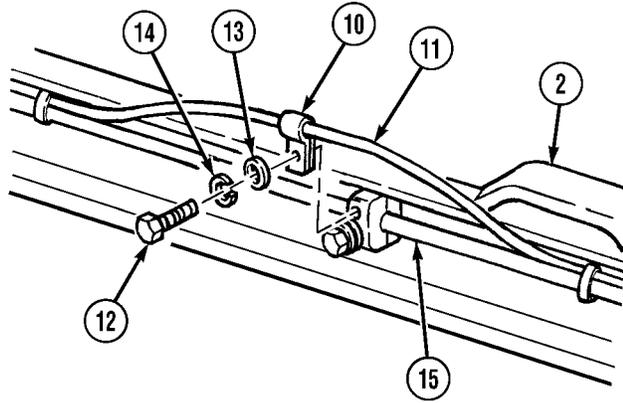
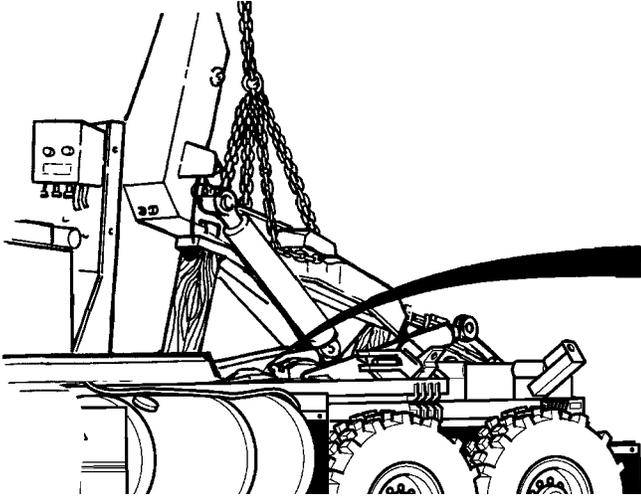

- (5) Install four cushion clips (10) on main wire harness (11).

WARNING

Adhesives, solvents, and sealing compounds can burn easily, give off harmful vapors, and are harmful to skin and clothing. To avoid injury or death, keep away from open fire and use in a well-ventilated area. If adhesive, solvent, or sealing compound gets on skin or clothing, wash immediately with soap and water.

NOTE

Do not apply sealing compound to upper screw, until cushion clips have been installed.

- (6) Apply sealing compound to threads of screws (12).
- (7) Install four cushion clips (10) with four washers (13), four lockwashers (14), and four screws (12) to compression frame tube (15) at inside of left compression frame rail (2).
- (8) Using cable ties, attach LHS main wire harness (11) to compression frame tube (15).
- (9) Using cable ties, attach LHS main wire harness (11) to main frame hoses (16) and main frame tubes (17).

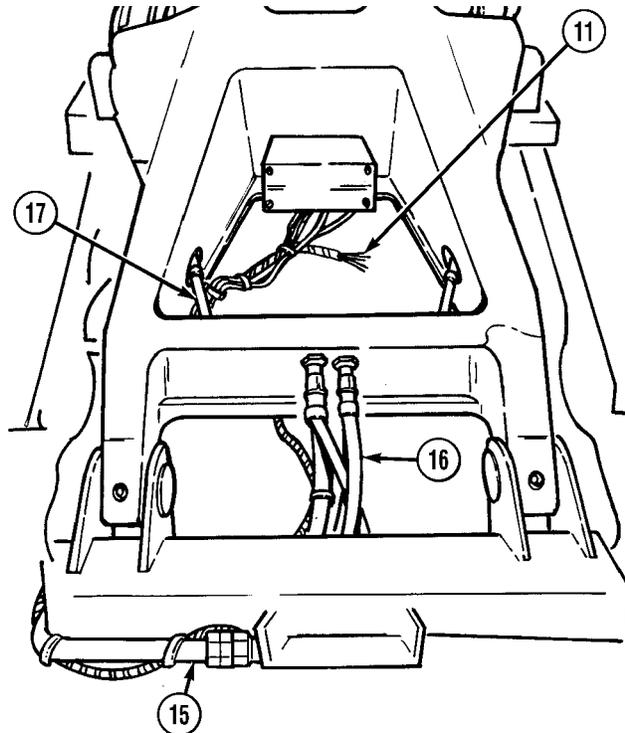

Direct Support and General Support Maintenance (Cont)

- (10) Install seven terminals (18) with wires (19) in LHS main wire harness connector MC87 (20) in the following positions:

Wire	Position
1461	A
1435	B
1435	C
1469	D
1466	E
1470	F
1475	G

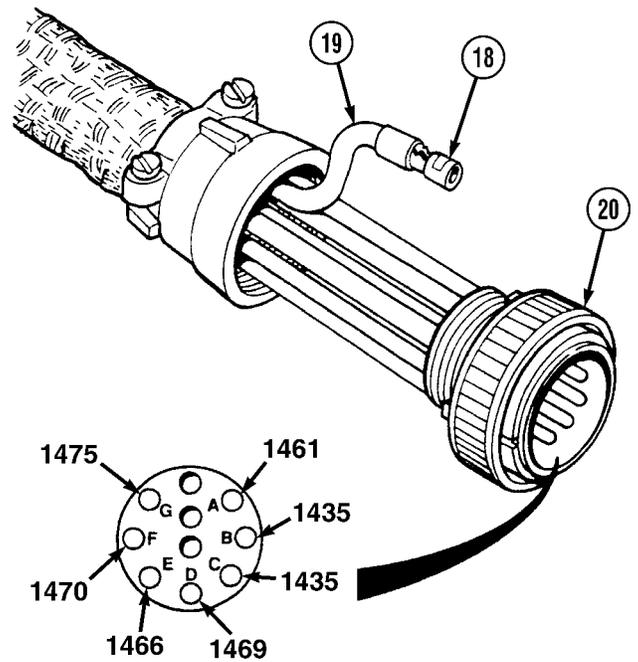

- (11) Install nut (21) on LHS main wire harness connector (20) and tighten two screws (22) on nut.

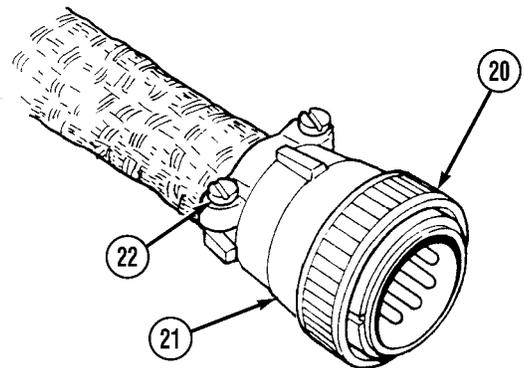

Direct Support and General Support Maintenance (Cont)

5-19. LOAD HANDLING SYSTEM (LHS) MAIN WIRE HARNESS REPLACEMENT (CONT).

- (12) Connect LHS main wire harness MC87 connector (20) to LHS junction box (23).

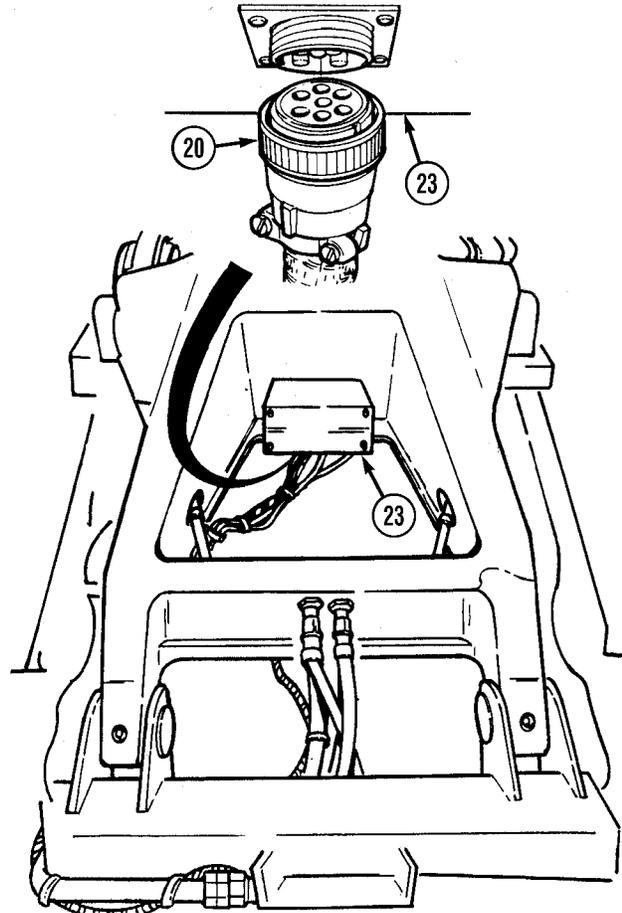

Direct Support and General Support Maintenance (Cont)

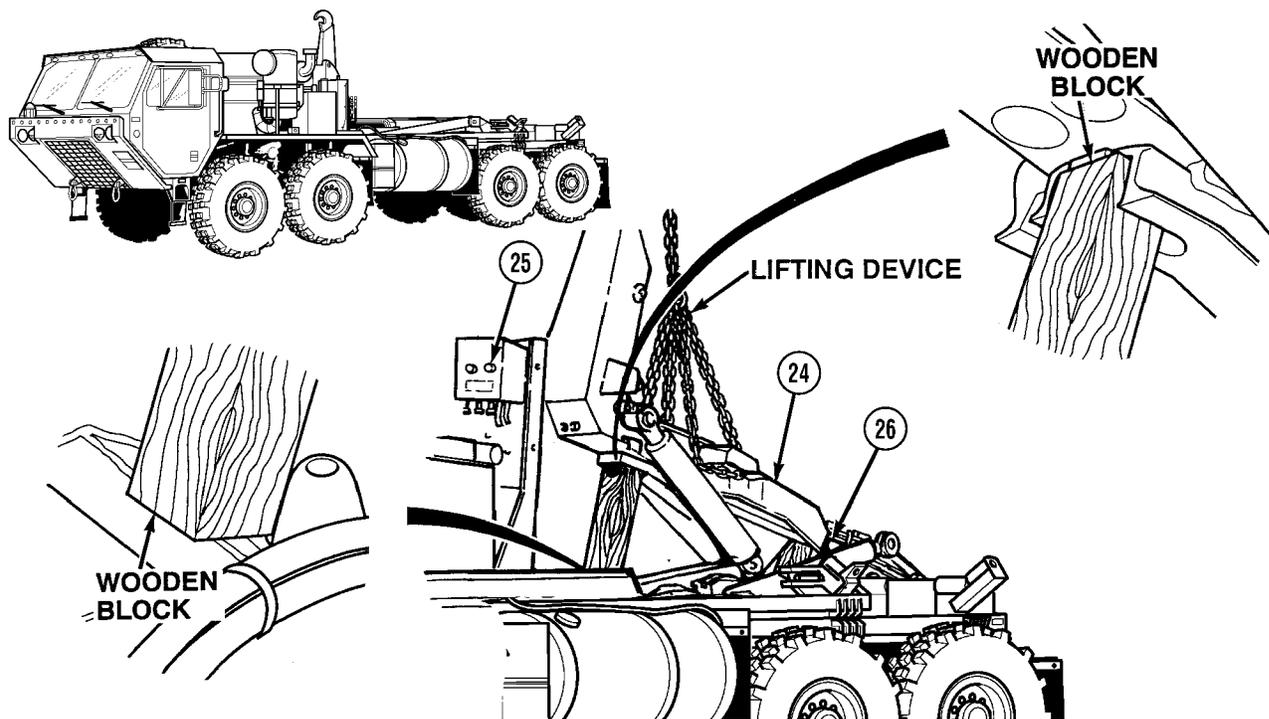
**WARNING**

Main frame weighs 2,500 lbs. (1 135 kg). Attach suitable lifting device prior to installation to prevent possible injury to personnel.

- (13) Attach lifting device to main frame (24).
- (14) Turn ENGINE switch to ON position.
- (15) With the aid of an assistant, push main frame safe lowering button (25) to lift main frame (24) and remove wooden block.
- (16) With the aid of an assistant, push safe lowering button (26) to lower main frame (24) to transit position.
- (17) Turn ENGINE switch to OFF position.

c. Follow-on Maintenance. Remove wheel chocks (TM 9-2320-279-10).

END OF TASK

Direct Support and General Support Maintenance (Cont)

5-20. REVERSE ALARM WIRING HARNESS REPLACEMENT.		
This task covers:		
a. Removal	b. Installation	c. Follow-on Maintenance
INITIAL SETUP		
<i>Models</i> M1120	<i>References</i> None	
<i>Test Equipment</i> None	<i>Equipment Condition</i> TM or Para	<i>Condition Description</i> TM 9-2320-279-10 Engine OFF TM 9-2320-279-10 Wheels chocked
<i>Special Tools</i> Tool Kit, General Mechanic's, Item 32, Appendix B	<i>Special Environmental Conditions</i> None	
<i>Supplies</i> Cable Ties, Item 4, Appendix F	<i>General Safety Instructions</i> None	
<i>Personnel Required</i> MOS 63W, Wheel vehicle repairer		

a. Removal.

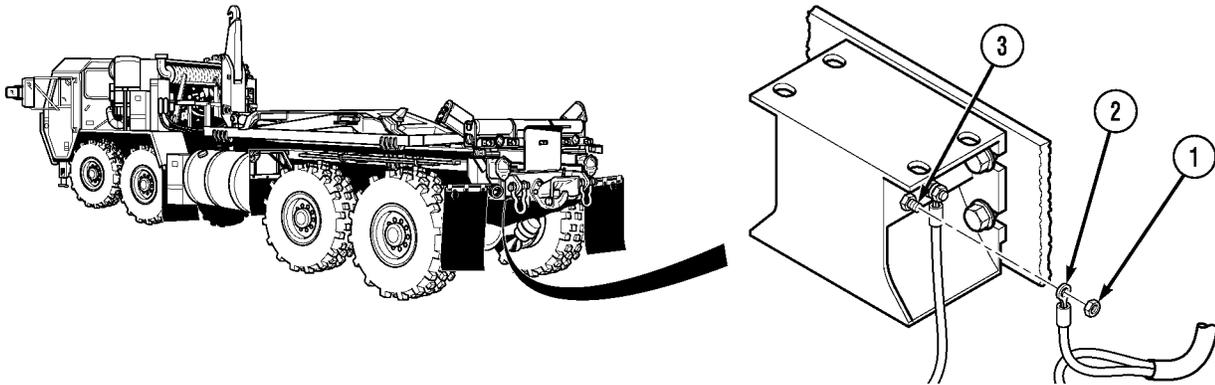

(1) Remove locknut (1) and wire 1665A (2) from positive reverse alarm terminal (3).

Direct Support and General Support Maintenance (Cont)

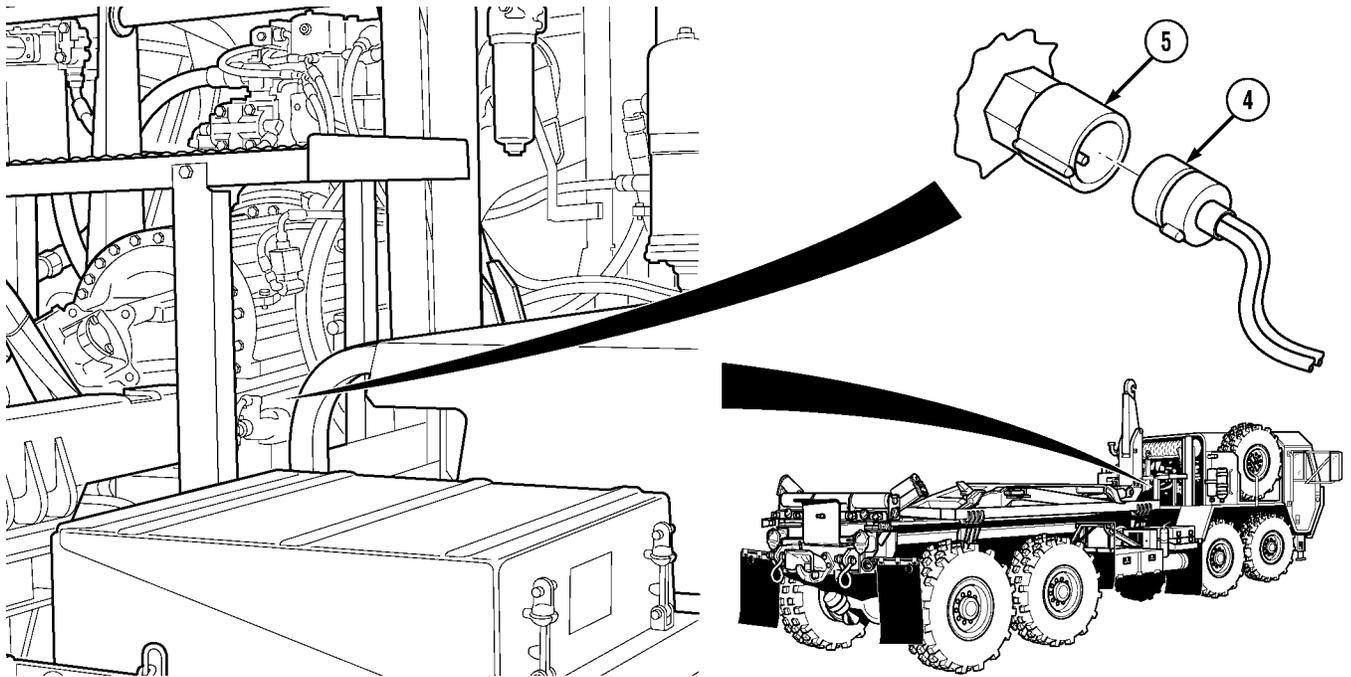

(2) Disconnect reverse alarm switch connector (4) from reverse alarm switch (5).

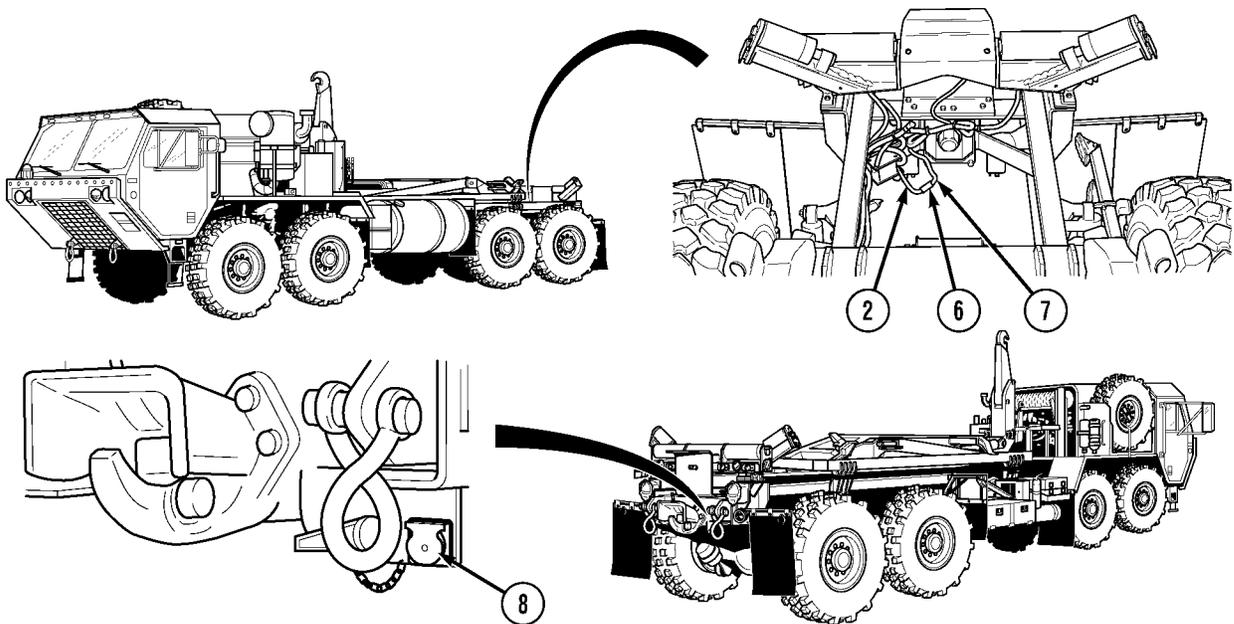

(3) Cut wire 1665 (2) at butt connector (6) in wire 665 (7) from military connector (8).

Direct Support and General Support Maintenance (Cont)

5-20. REVERSAL ALARM WIRING HARNESS REPLACEMENT (CONT).

NOTE

- Remove cable ties as needed.
 - Remove cable clamps as needed.
- (4) Remove reverse alarm wiring harness (9).

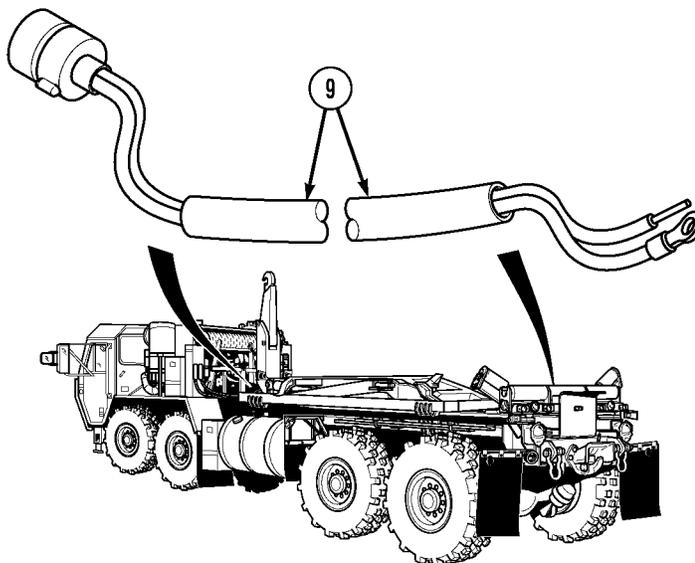

b. Installation.

NOTE

- Install cable clamps as needed.
 - Install cable ties as needed.
- (1) Install reverse alarm wiring harness (1).

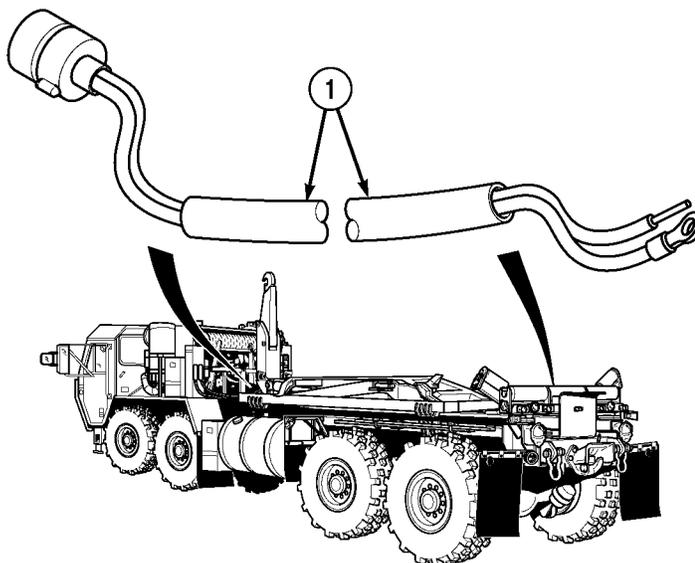

Direct Support and General Support Maintenance (Cont)

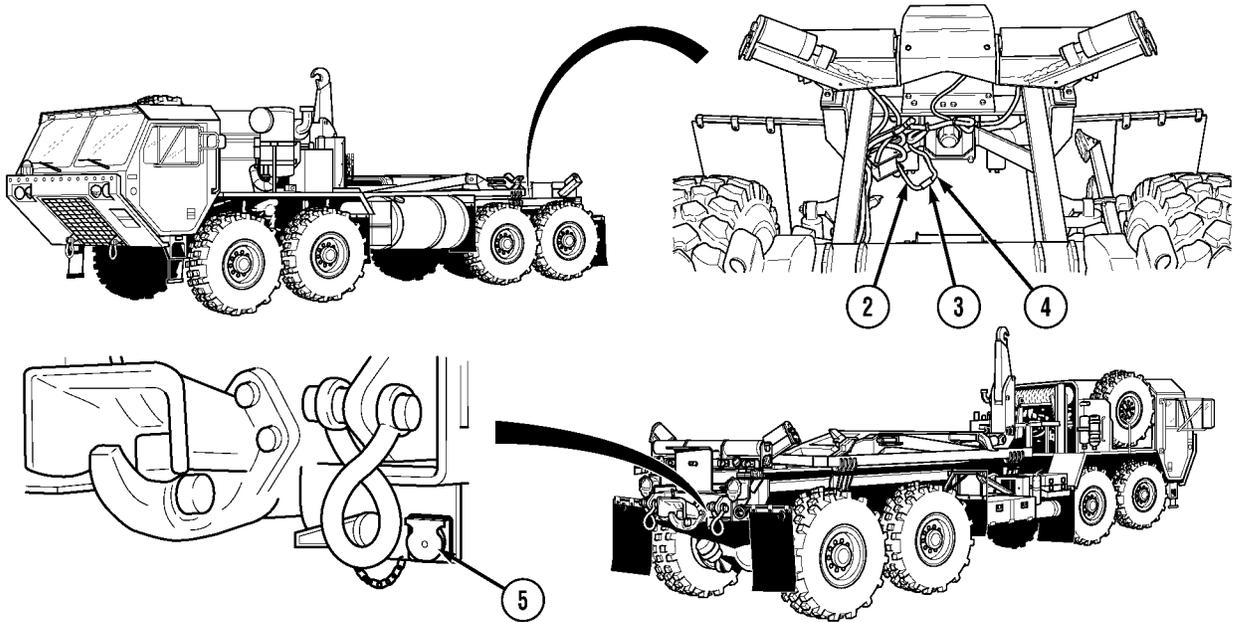

(2) Install wire 1665 (2) with butt connector (3) in wire 665 (4) from military connector (5).

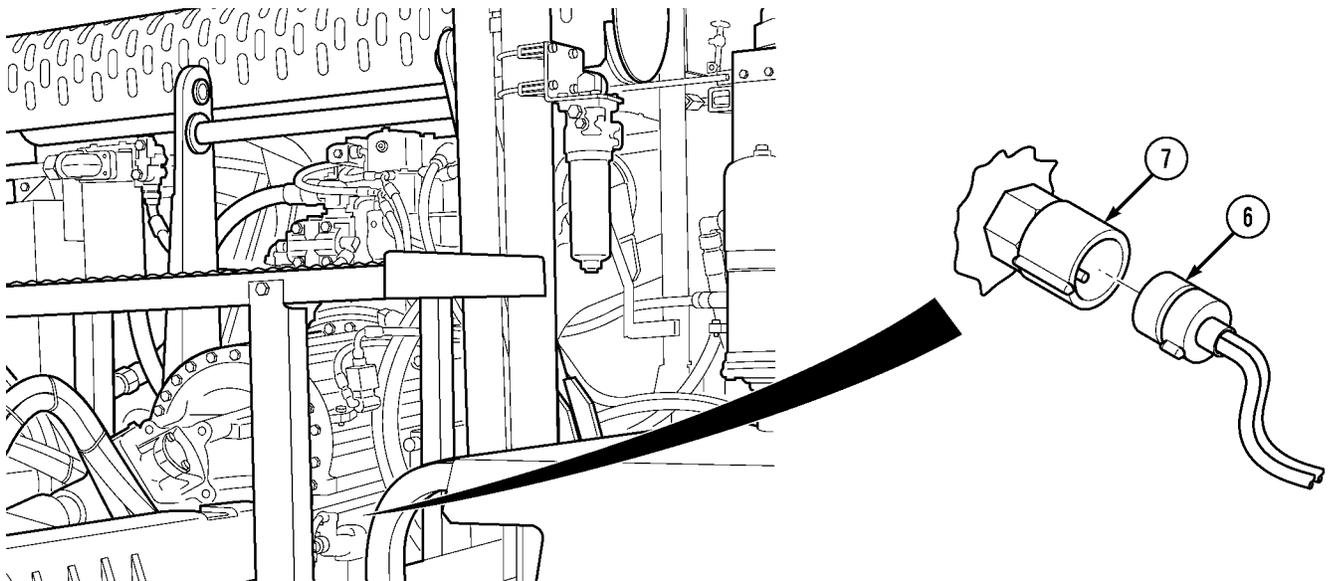

(3) Install reverse alarm switch connector (6) in reverse alarm switch (7).

Direct Support and General Support Maintenance (Cont)

5-20. REVERSAL ALARM WIRING HARNESS REPLACEMENT (CONT).

- (4) Install wire 1665A (2) and locknut (8) on positive reverse alarm terminal (9).

c. Follow-on Maintenance. Remove wheel chocks (TM 9-2320-279-10).

END OF TASK

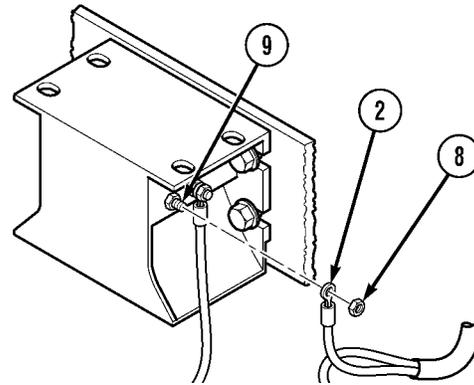

Direct Support and General Support Maintenance (Cont)

5-21. LOAD HANDLING SYSTEM (LHS) RUBBER BUMPER REPLACEMENT.								
This task covers:								
a. Removal	b. Installation	c. Follow-on Maintenance						
INITIAL SETUP								
<i>Models</i> M1120	<i>References</i> None							
<i>Test Equipment</i> None	<i>Equipment Condition</i> <table border="0"> <tr> <td><i>TM or Para</i></td> <td><i>Condition Description</i></td> </tr> <tr> <td>TM 9-2320-279-10</td> <td>Engine OFF</td> </tr> <tr> <td>TM 9-2320-279-10</td> <td>Wheels chocked</td> </tr> </table>		<i>TM or Para</i>	<i>Condition Description</i>	TM 9-2320-279-10	Engine OFF	TM 9-2320-279-10	Wheels chocked
<i>TM or Para</i>	<i>Condition Description</i>							
TM 9-2320-279-10	Engine OFF							
TM 9-2320-279-10	Wheels chocked							
<i>Special Tools</i> Tool Kit, General Mechanic's, Item 32, Appendix B	<i>Special Environmental Conditions</i> None							
<i>Supplies</i> Sealing Compound, Item 16, Appendix F Locknut (2), Item 5, Appendix K Lockwasher (2), Item 14, Appendix K Lockwasher (2), Item 20, Appendix K	<i>General Safety Instructions</i> None							
<i>Personnel Required</i> MOS 63W, Wheel vehicle repairer								

a. Removal.

- (1) Remove locknut (1) and rubber bumper (2) from compression frame (3). Discard Locknut.

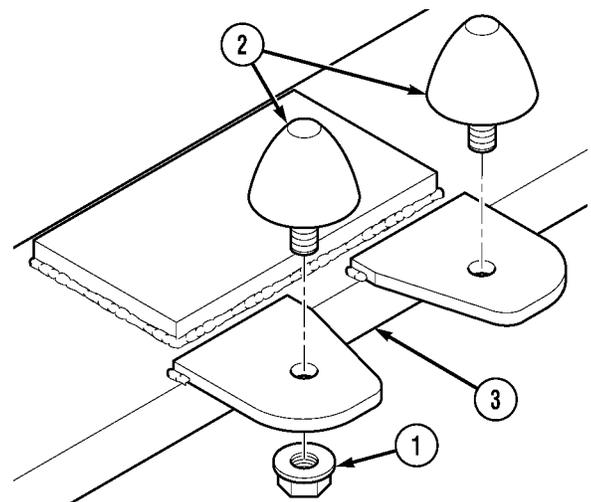

Direct Support and General Support Maintenance (Cont)

5-21. LOAD HANDLING SYSTEM (LHS) RUBBER BUMPER REPLACEMENT (CONT).

b. Installation.

WARNING

Adhesives, solvents, and sealing compounds can burn easily, give off harmful vapors, and are harmful to skin and clothing. To avoid injury or death, keep away from open fire and use in a well-ventilated area. If adhesive, solvent, or sealing compound gets on skin or clothing, wash immediately with soap and water.

NOTE

Compression frame rubber bumpers shown. Installation procedure is the same for all rubber bumpers.

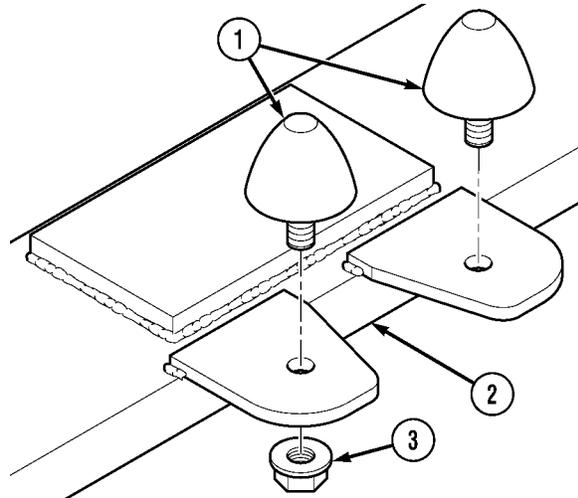

- (1) Coat threads of rubber bumpers (1) with sealing compound.
- (2) Install rubber bumpers (1) in compression frame (2).
- (3) Install locknut (3) on rubber bumpers (1).

c. Follow-on Maintenance. Remove wheel chocks (TM 9-2320-279-10).

END OF TASK

Direct Support and General Support Maintenance (Cont)

5-22. LOAD HANDLING SYSTEM (LHS) HOOK REPLACEMENT.		
This task covers:		
a. Removal	b. Installation	c. Follow-on Maintenance
INITIAL SETUP		
<i>Models</i> M1120	<i>Personnel Required</i> MOS 63W, Wheel vehicle repairer	
<i>Test Equipment</i> None	<i>References</i> None	
<i>Special Tools</i> Tool Kit, General Mechanic's, Item 32, Appendix B Lifting Device, Minimum Capacity 200 lbs. (91 kg)	<i>Equipment Condition</i>	
	<i>TM or Para</i>	<i>Condition Description</i>
	TM 9-2320-279-10	Engine OFF
	TM 9-2320-279-10	Wheels chocked
<i>Supplies</i> Compound, Antiseize, Item 6, Appendix F Pin, Cotter, Item 32, Appendix K	<i>Special Environmental Conditions</i> None	
	<i>General Safety Instructions</i> None	

Direct Support and General Support Maintenance (Cont)

5-22. LOAD HANDLING SYSTEM (LHS) HOOK REPLACMENT (CONT).

a. Removal.

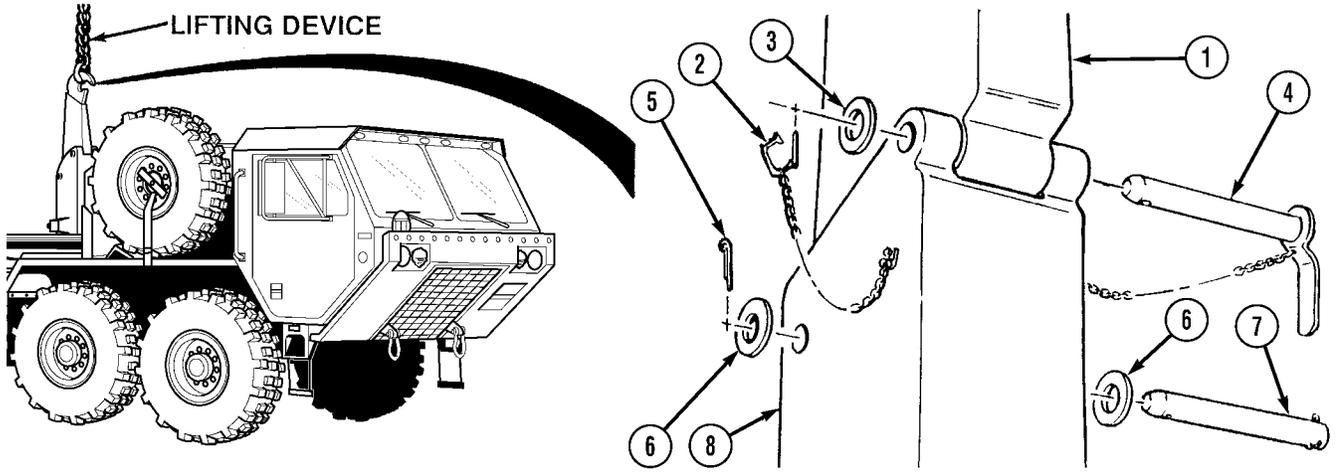

WARNING

Lift hook weighs 200 lbs. (91 kg). Attach suitable lifting device prior to removal to prevent possible injury to personnel.

- (1) Attach lifting device to support lift hook (1).
- (2) Remove snapper pin (2), washer (3), and retaining pin (4).
- (3) Remove cotter pin (5), two washers (6), pivot pin (7), and lift hook (1) from hook arm (8). Discard cotter pin.
- (4) Remove lifting device from lift hook (1).

b. Installation.

WARNING

Lift hook weighs 200 lbs. (91 kg). Attach suitable lifting device prior to installation to prevent possible injury to personnel.

- (1) Attach lifting device to lift hook (1).

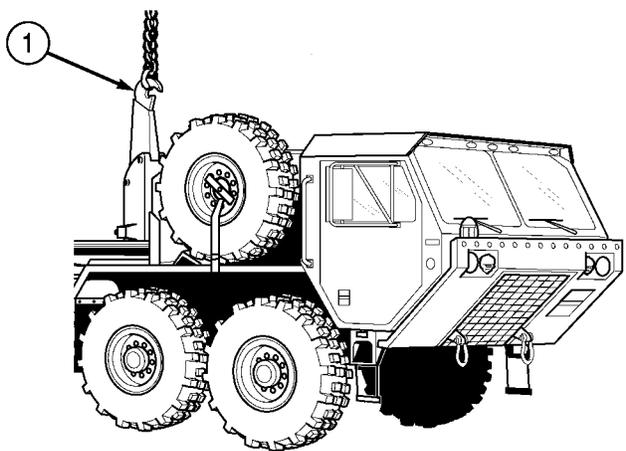

Direct Support and General Support Maintenance (Cont)

WARNING

Adhesives, solvents, and sealing compounds can burn easily, can give off harmful vapors, and are harmful to skin and clothing. To avoid injury or death, keep away from open fire and use in a wellventilated area. If adhesive, solvent, or sealing compound gets on skin or clothing, wash immediately with soap and water.

- (2) Apply antiseize compound to pivot pin (2).
- (3) Using lifting device, install lift hook (1) on hook arm (3) with pivot pin (2), two washers (4), and cotter pin (5).
- (4) Apply antiseize compound to retaining pin (6).
- (5) Install retaining pin (6), washer (7), and snapper pin (8) on lift hook (1).
- (6) Remove lifting device from lift hook (1).

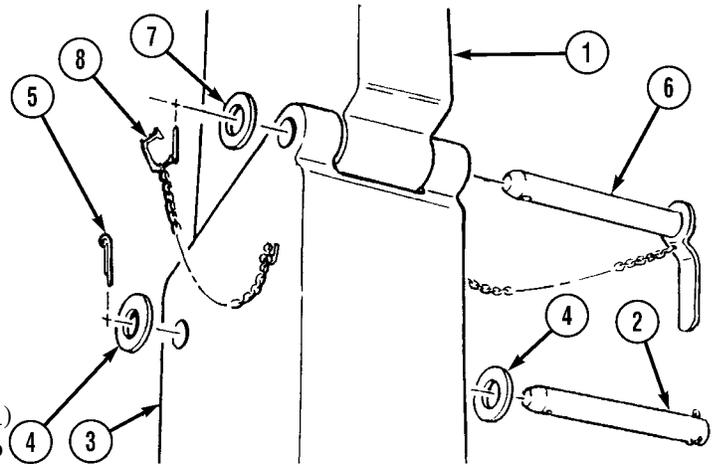

c. Follow-on Maintenance. Remove wheel chocks (TM 9-2320-279-10).

END OF TASK

Direct Support and General Support Maintenance (Cont)

5-23. LOAD HANDLING SYSTEM (LHS) HOOK ARM REPAIR.	
This task covers:	
a. Removal	c. Cleaning/Inspection
b. Disassembly	d. Assembly
	e. Installation
	f. Follow-on Maintenance
INITIAL SETUP	
<i>Models</i>	<i>Personnel Required</i>
M1120	MOS 63W, Wheel vehicle repairer
<i>Test Equipment</i>	<i>References</i>
None	TC 9-237
<i>Special Tools</i>	<i>Equipment Condition</i>
Tool Kit, General Mechanic's, Item 32, Appendix B	<i>TM or Para</i> <i>Condition Description</i>
Gloves, Chemical Oil Protective, Item 11, Appendix B	TM 9-2320-279-10 Engine OFF
Goggles, Industrial, Item 12, Appendix B	TM 9-2320-279-10 Wheels chocked
Pliers, Retaining Ring, Item 19, Appendix B	Para 5-22 LHS hook removed
Wrench, Combination, 2-1/8 in., Item 43, Appendix B	Para 5-37 LHS Hook arm cylinders removed
LHS Bushing Remover, Appendix H	<i>Special Environmental Conditions</i>
LHS Bushing Remover/Installer (Large), Appendix H	None
LHS Bushing Remover/Installer (Small), Appendix H	<i>General Safety Instructions</i>
LHS Lead Screw, Appendix H	None
LHS Washer, Appendix H	
Lifting Device, Minimum Capacity 1,100 lbs. (499 kg)	
Wood Block (2), Appendix H	
<i>Supplies</i>	
Cloth, Cleaning, Item 5, Appendix F	
Grease, General Purpose, Item 8, Appendix F	
Solvent, Drycleaning, Item 18, Appendix F	
Locknut (2), Item 5, Appendix K	
Ring, Retaining (2), Item 41, Appendix K	
Seal (4), Item 44, Appendix K	

Direct Support and General Support Maintenance (Cont)

a. Removal.

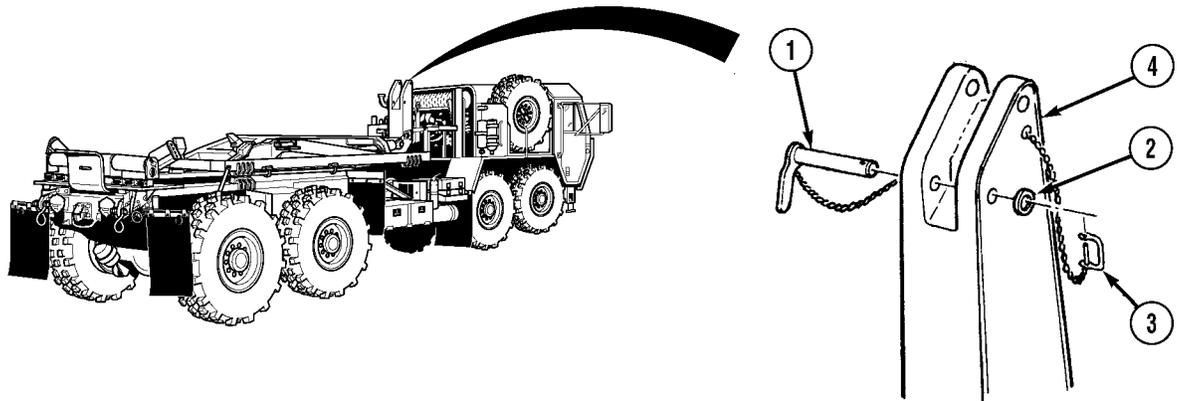

- (1) Install pivot pin (1), washer (2), and snapper pin (3) in hook arm (4).

WARNING

Hook arm weighs 1,100 lbs. (499 kg). Attach suitable lifting device prior to removal to prevent possible injury to personnel.

- (2) Attach lifting device to hook arm (4).

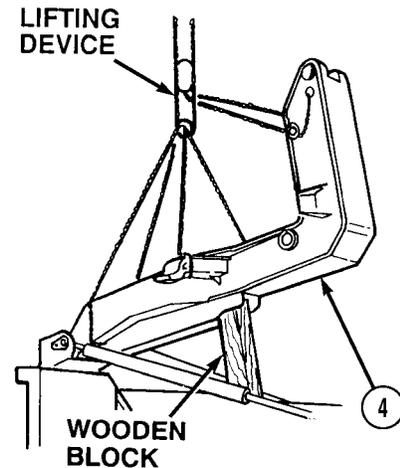

WARNING

Use care when removing retaining rings. Retaining rings are under tension and can act as projectiles when released causing injury to personnel.

- (3) Using lifting device, support hook arm (4) and remove two retaining rings (5), pivot pins (6), and shims (7) from hook arm and main frame (8). Discard retaining rings.
- (4) Using lifting device, remove hook arm (4) from main frame (8).
- (5) Remove lifting device from hook arm (4).

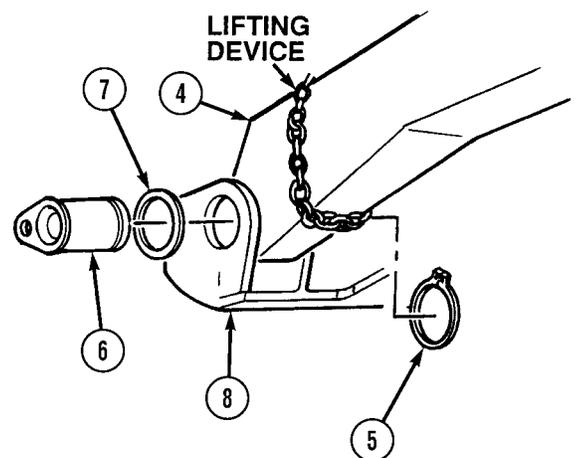

Direct Support and General Support Maintenance (Cont)

5-23. LOAD HANDLING SYSTEM (LHS) HOOK ARM REPAIR (CONT).

b. Disassembly.

WARNING

- Unsafe welding practices can cause serious injury from fire, explosions, or harmful agents. Allow only authorized personnel to weld or cut metals, and follow safety precautions in TC 9-237. Protective clothing and goggles must be worn, adequate protective equipment used, a suitable fire extinguisher kept nearby, and requirements of TC 9-237 strictly followed.
- CARC paint contains isocyanate (HDI) which is highly irritating to skin and respiratory system. High concentrations of HDI can produce symptoms of itching and reddening of skin, a burning sensation in throat and nose, and watering of the eyes. In extreme concentrations, HDI can cause cough, shortness of breath, pain during respiration, increased sputum production, and chest tightness. The following precautions must be taken whenever using CARC paint:
 - ALWAYS use air line respirators when using CARC paint unless air sampling shows exposure to be below standards. Use chemical cartridge respirator if air sampling is below standards.
 - DO NOT let skin or eyes come in contact with CARC paint. Always wear protective equipment (gloves, ventilation mask, safety goggles, etc.).
 - DO NOT use CARC paint without adequate ventilation.
 - NEVER weld or cut CARC-coated materials.
 - DO NOT grind or sand painted equipment without high-efficiency air-purifying respirators in use.
 - BE AWARE of CARC paint exposure symptoms; symptoms can occur a few days after initial exposure. Seek medical help immediately if symptoms are detected.

NOTE

If hook arm retaining pin or snapper pin replacement is necessary, grind chain tack weld smooth on hook arm surface and tack weld pin chain at same location.

- (1) Remove two locknuts (1) and rubber bumpers (2) from hook arm (3). Discard locknuts.

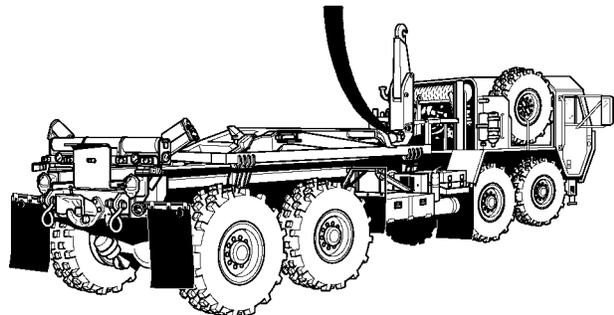
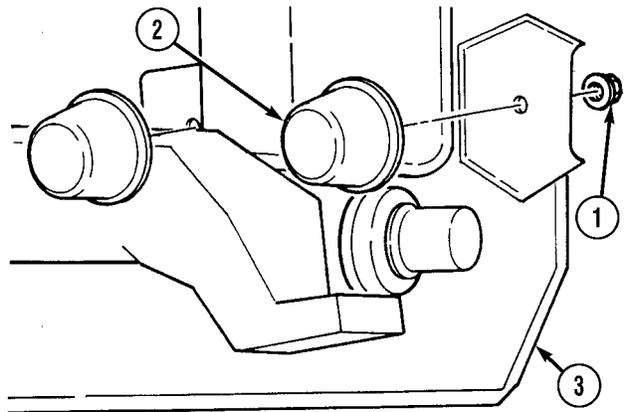

Direct Support and General Support Maintenance (Cont)**NOTE**

Seals are removed by prying out.

- (2) Remove four seals (4) from hook arm (3). Discard seals.
- (3) Remove two lube fittings (5) from hook arm (3).

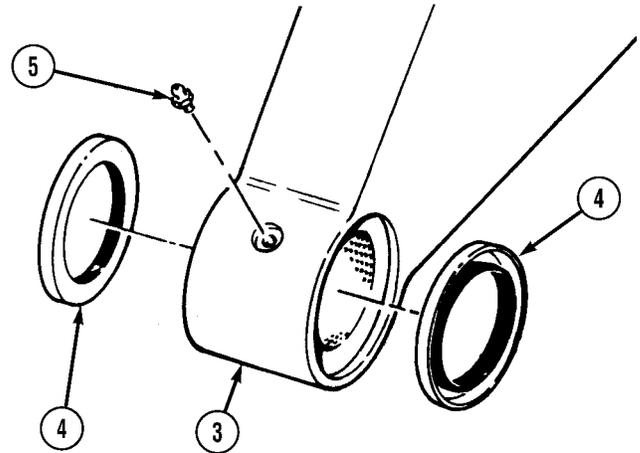

- (4) Using hook arm and main frame bushing removal/installation tool (six pieces), remove two bushings (6) from hook arm (3) as shown.

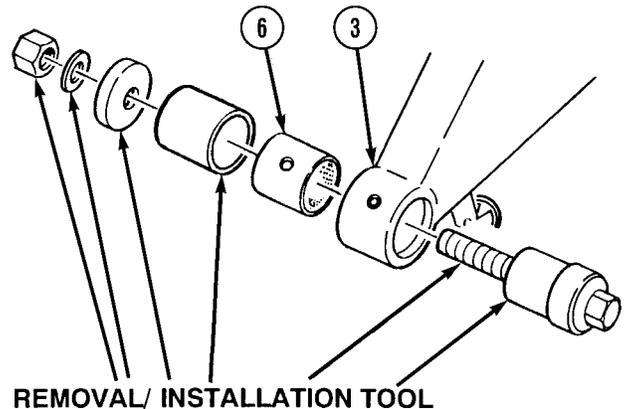
**c. Cleaning/Inspection.****WARNING**

- Drycleaning solvent (P-D-680) is TOXIC and flammable. Wear protective goggles, face shield, and gloves; use only in a well-ventilated area; avoid contact with skin, eyes, and clothes; and do not breathe vapors. Keep away from heat or flame. Never smoke when using solvent. The flashpoint for Type III Drycleaning Solvent is 200°F (93°C). Failure to do so may result in injury or death to personnel.
- If personnel become dizzy while using cleaning solvent, immediately get fresh air and medical help. If solvent contacts skin or clothes, flush with cold water. If solvent contacts eyes, immediately flush eyes with water and get immediate medical attention.

- (1) Clean metal surfaces with drycleaning solvent (P-D-680) (Item 18, Appendix F) and wipe seals and bushings with a clean cloth.
- (2) Inspect hook arm for cracked welds and damage. Replace or repair as necessary.
- (3) Inspect bushing for wear. Replace bushing if pivot pin has worn through bushing surface and metal is showing through.
- (4) Wipe rubber bumpers with a clean cloth; do not use drycleaning solvent. Replace rubber bumpers if rubber part is cracking, crumbling, or loose from threaded metal base.

Direct Support and General Support Maintenance (Cont)

5-23. LOAD HANDLING SYSTEM (LHS) HOOK ARM REPAIR (CONT).

d. Assembly.

NOTE

- Apply light coat of grease to outer surface of bushings prior to installation.
 - Apply light coat of grease to threads of removal/installation tool prior to use.
- (1) Using hook arm and main frame bushing removal/installation tool (use five of six pieces), aline lube hole in bushing (1) with lube fitting hole in hook arm (2) and install two bushings in hook arm as shown.

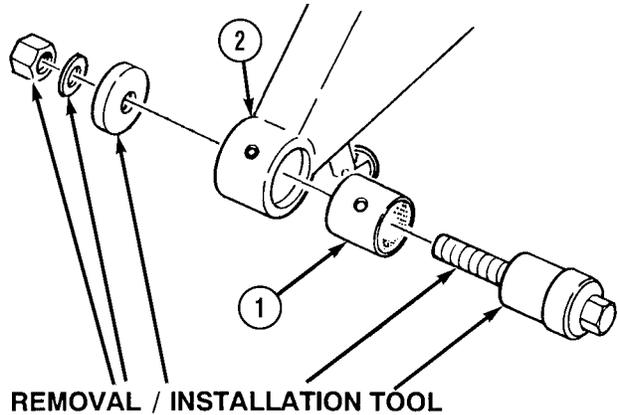

NOTE

If lube fitting hole is restricted by bushing, go to step (4) of removal.

- (2) Check lube fitting hole in hook arm (2) for restrictions.
- (3) Install two lube fittings (3) in hook arm (2).

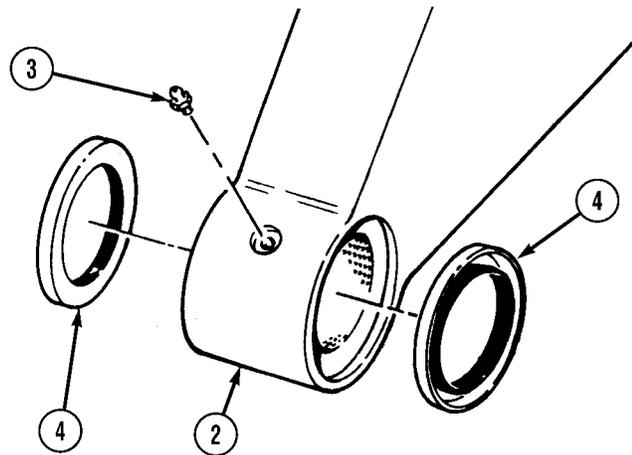

NOTE

Apply light coat of grease to outer edges of seals prior to installation.

- (4) Install four seals (4) in hook arm (2).
- (5) Install two rubber bumpers (5) on hook arm (2) with two locknuts (6).

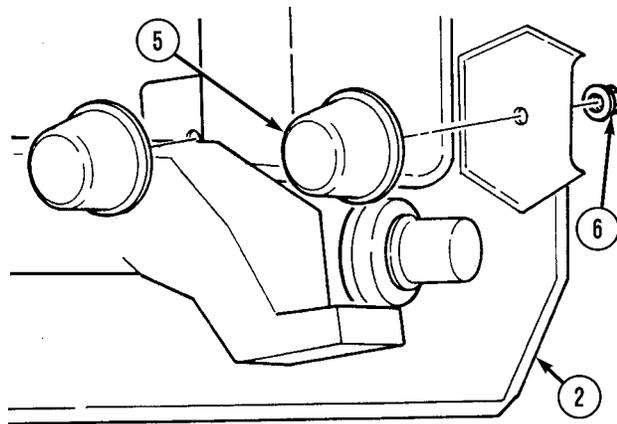

Direct Support and General Support Maintenance (Cont)

e. Installation.

WARNING

- Hook arm weighs 1,100 lbs. (499 kg). Attach suitable lifting device prior to installation to prevent possible injury to personnel.
 - Ensure hook arm is supported with wooden blocks during installation to prevent possible injury to personnel.
- (1) Attach lifting device to hook arm (1) and place hook arm in installation position on main frame (2).
 - (2) Apply light coat of grease to pivot pins (4).
 - (3) Install two shims (3) with pivot pins (4) on main frame (2) and hook arm (1).

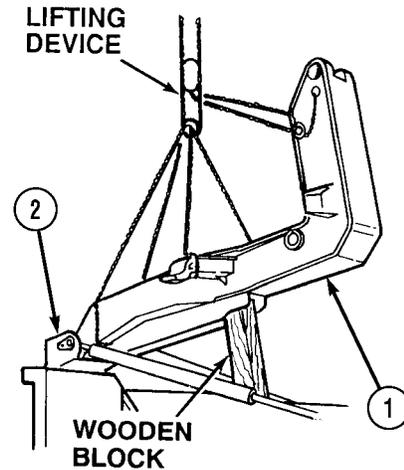

WARNING

Use care when installing retaining rings. Retaining rings are under tension and can act as projectiles when released causing injury to personnel.

- (4) Install two retaining rings (5) on pivot pins (4).
- (5) Remove lifting device from hook arm (1).
- (6) Remove snapper pin (6) from pivot pin (7).
- (7) Remove washer (8) and pivot pin (7).

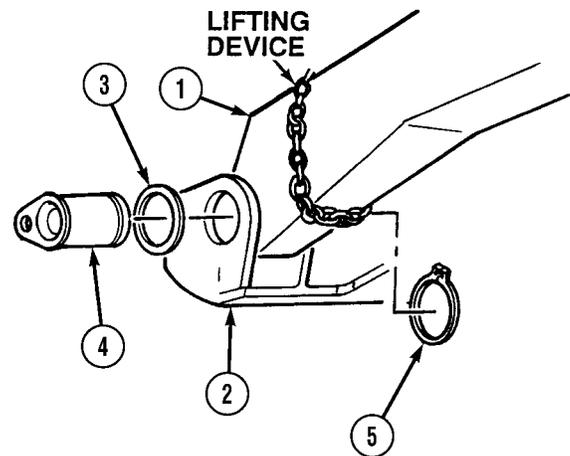

f. Follow-on Maintenance.

- (1) Install LHS hook arm cylinders (Para 5-37).
- (2) Install LHS hook (Para 5-22).
- (3) Remove wheel chocks (TM 9-2320-279-10).

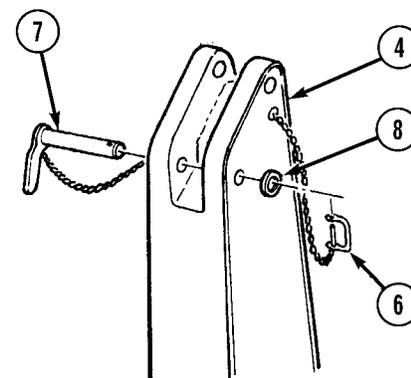

END OF TASK

Direct Support and General Support Maintenance (Cont)

5-24. LOAD HANDLING SYSTEM (LHS) MAIN FRAME REPAIR.	
This task covers:	
a. Removal	c. Cleaning/Inspection
b. Disassembly	d. Assembly
e. Installation	
f. Follow-on Maintenance	
INITIAL SETUP	
<i>Models</i>	<i>Personnel Required</i>
M1120	MOS 63W, Wheel vehicle repairer
<i>Test Equipment</i>	<i>References</i>
None	None
<i>Special Tools</i>	<i>Equipment Condition</i>
Tool Kit, General Mechanic's, Item 32, Appendix B	<i>TM or Para</i> <i>Condition Description</i>
Cap and Plug Set, Item 2, Appendix B	TM 9-2320-279-10 Engine OFF
Gloves, Chemical Oil Protective, Item 11, Appendix B	TM 9-2320-279-10 Wheels chocked
Goggles, Industrial, Item 12, Appendix B	TM 9-2320-279-20 Batteries disconnected
Pliers, Retaining Ring, Item 19, Appendix B	Para 5-23 LHS hook arm removed
Tape, Measuring, Item 25, Appendix B	Para 4-36 Proximity switch (hook arm up) removed
Wrench, Combination, 1-13/16 in., Item 41, Appendix B	Para 4-37 Proximity switch (main frame down) removed
LHS Bushing Remover, Appendix H	Para 5-25 Main frame tubes removed
LHS Bushing Remover/Installer (Large), Appendix H	Para 4-41 LHS junction box removed
LHS Bushing Remover/Installer (Small), Appendix H	<i>Special Environmental Conditions</i>
LHS Lead Screw, Appendix H	None
LHS Washer, Appendix H	<i>General Safety Instructions</i>
Wooden Blocks (2), Appendix H	None
Lifting Device, Minimum Capacity 1,100 lbs. (499 kg)	
<i>Supplies</i>	
Cable Ties, Item 4, Appendix F	
Grease, General Purpose, Item 8, Appendix F	
Solvent, Drycleaning, Item 18, Appendix F	
Tags, Identification, Item 19, Appendix F	
Lockwasher, Item 21, Appendix K	
Ring, Retaining (4), Item 41, Appendix K	
Seal, Item 44, Appendix K	

Direct Support and General Support Maintenance (Cont)

a. Removal.

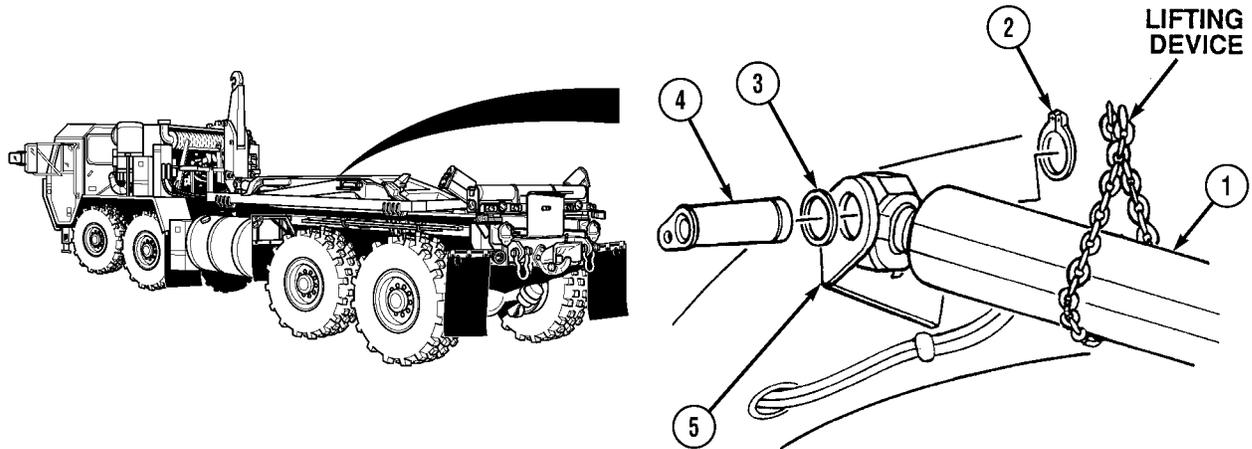

WARNING

Main frame cylinder weighs 325 lbs. (148 kg). Attach suitable lifting device prior to removal to prevent possible injury to personnel.

NOTE

Left and right main cylinders are removed the same way.

- (1) Attach lifting device to left main frame cylinder (1).

WARNING

Use care when removing retaining rings. Retaining rings are under tension and can act as projectiles when released causing injury to personnel.

- (2) Using lifting device, support left main frame cylinder (1) and remove retaining ring (2), shim (3), and pivot pin (4).
- (3) Lower left main frame cylinder (1) out of main frame (5).
- (4) Remove lifting device from left main frame cylinder (1).
- (5) Repeat Steps (1) through (4) for right main frame cylinder (1).

Direct Support and General Support Maintenance (Cont)

5-24. LOAD HANDLING SYSTEM (LHS) MAIN FRAME REPAIR (CONT).

- (6) Remove connector (6) from junction box (7).
- (7) Remove cable ties (8) from main harness (9).

WARNING

The LHS hydraulic system operates at oil pressures up to 1,725 psi (11 894 kPa). Never disconnect any hydraulic line or fitting without first dropping pressure to zero. Failure to comply may result in serious injury or death to personnel.

NOTE

- Tag and mark all hoses prior to removal.
 - Cap and plug all hoses and fittings after removal.
- (8) Remove hoses 2881 (10), 2882 (11), 2891 (12), and 2892 (13) from main frame bulkhead fittings (14).

WARNING

Main frame weighs 1,000 lbs. (454 kg). Attach suitable lifting device prior to removal to prevent possible injury to personnel.

- (9) Attach lifting device to main frame (5).
- (10) With the aid of another soldier, use lifting device and wooden blocks to support main frame (5).

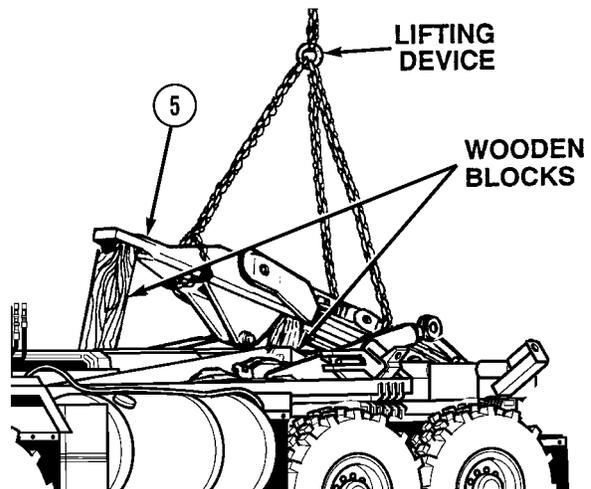
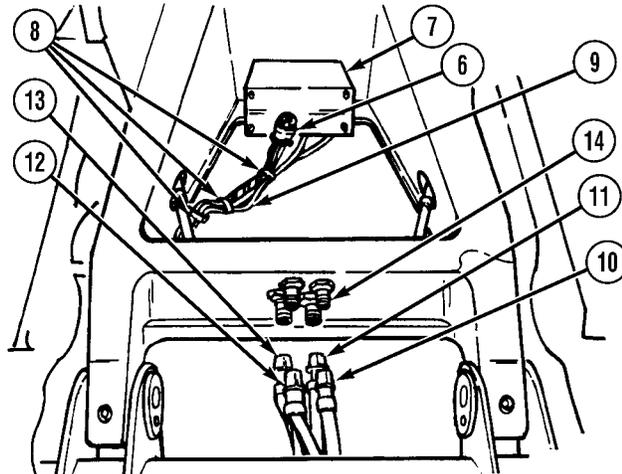

Direct Support and General Support Maintenance (Cont)

WARNING

Use care when removing retaining rings. Retaining rings are under tension and can act as projectiles when released causing injury to personnel.

- (11) With the aid of another soldier, remove two retaining rings (15), shims (16), and pivot pins (17) from main frame (5). Discard retaining rings.

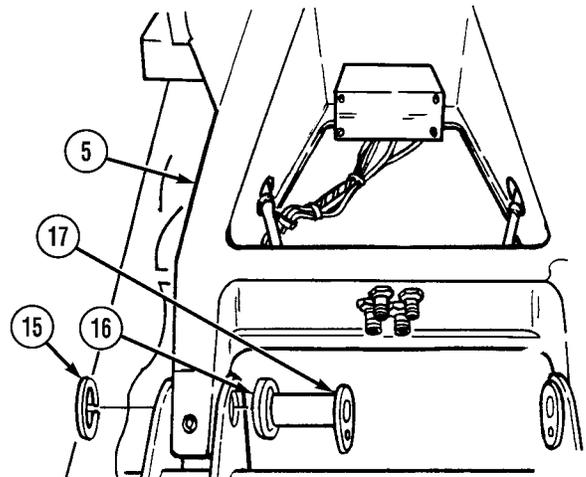

CAUTION

Do not allow wooden blocks supporting middle frame to fall when main frame is lifted, or damage to equipment may result.

- (12) With the aid of another soldier and using lifting device, remove main frame (5) from truck.
- (13) Remove lifting device from main frame (5).

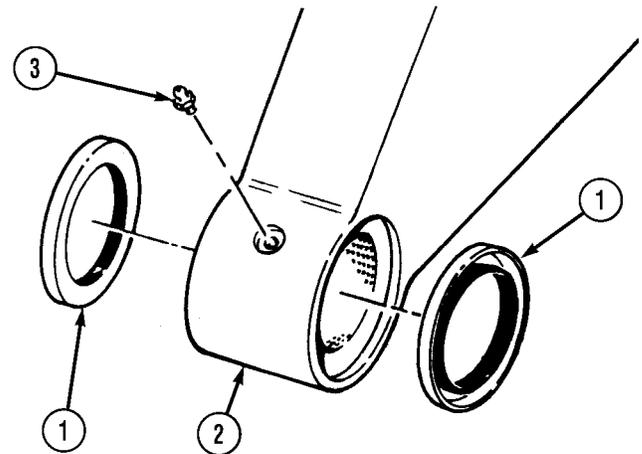

b. Disassembly.

NOTE

Seals are removed by prying out.

- (1) Remove four seals (1) from main frame (2). Discard seals.
- (2) Remove two lube fittings (3) from main frame (2).
- (3) Using removal/installation tool (six pieces), remove two bushings (4) from main frame (2) as shown.

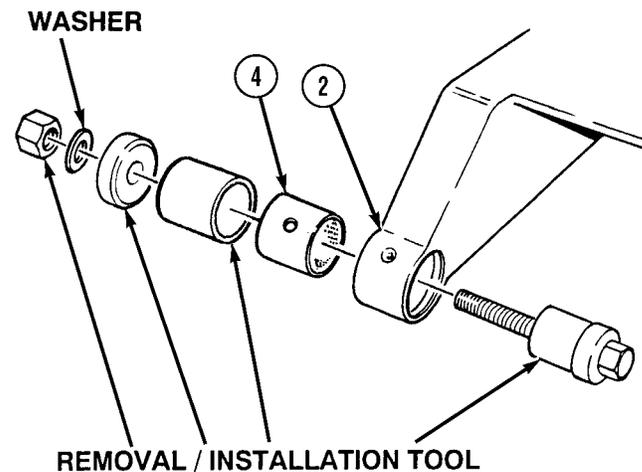

Direct Support and General Support Maintenance (Cont)

5-24. LOAD HANDLING SYSTEM (LHS) MAIN FRAME REPAIR (CONT).

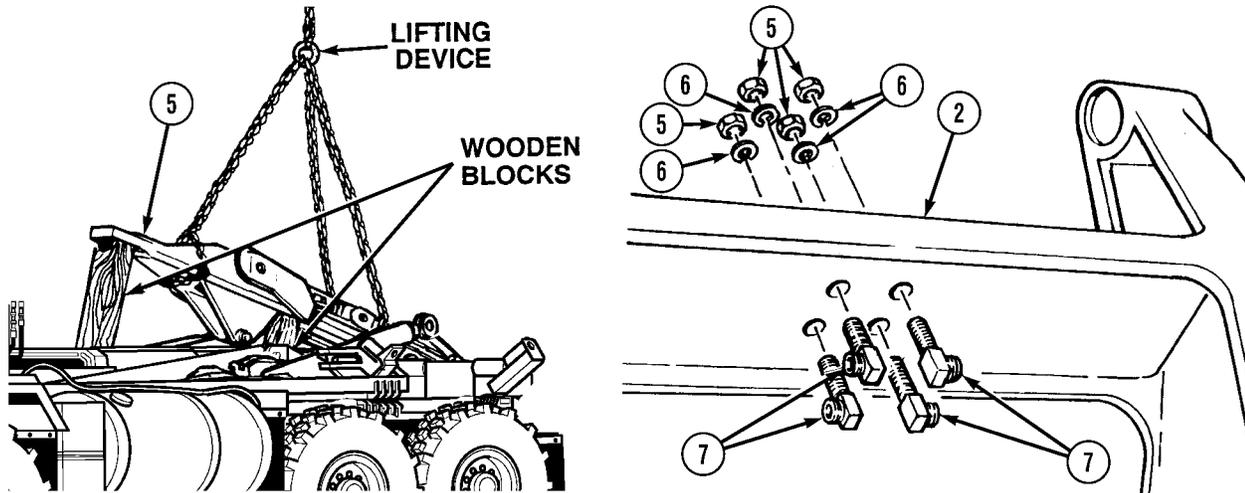

- (4) Remove four locknuts (5), lockwashers (6), and bulkhead fittings (7) from main frame (2). Discard locknuts.

c. Cleaning/Inspection.

WARNING

- Drycleaning solvent (P-D-680) is TOXIC and flammable. Wear protective goggles, face shield, and gloves; use only in a well-ventilated area; avoid contact with skin, eyes, and clothes; and do not breathe vapors. Keep away from heat or flame. Never smoke when using solvent. The flashpoint for Type III Drycleaning Solvent is 200° F (93° C). Failure to do so may result in injury or death to personnel.
- If personnel become dizzy while using cleaning solvent, immediately get fresh air and medical help. If solvent contacts skin or clothes, flush with cold water. If solvent contacts eyes, immediately flush eyes with water and get immediate medical attention.

- (1) Clean all metal surfaces with drycleaning solvent (P-D-680).
 (2) Inspect main frame for cracked welds or damage. Replace or repair as necessary.
 (3) Inspect bushing for wear. Replace if pivot pin has worn through bushing surface and metal is showing through.

Direct Support and General Support Maintenance (Cont)

d. Assembly.

- (1) Install four bulkhead fittings (1), lockwashers (2), and nuts (3) on main frame (4).

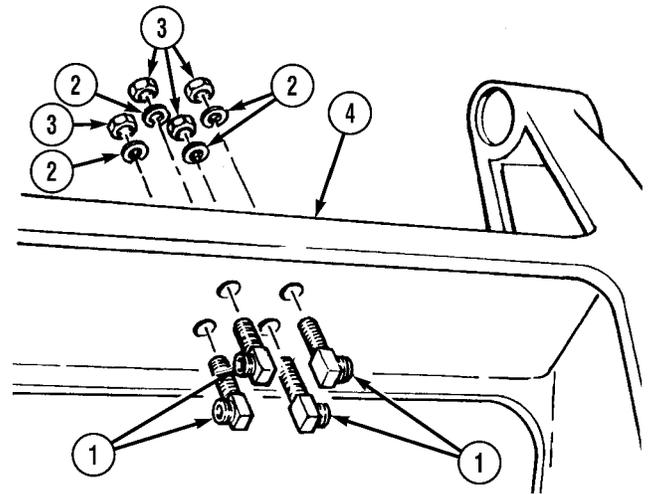

NOTE

- Apply light coat of grease to outer surface of bushings prior to installation.
 - Apply light coat of grease to threads of removal/installation tool prior to use.
- (2) Using hook arm and main frame bushing removal/installation tool, align lube hole in bushing (5) with lube fitting hole in main frame (4) and install two bushings (5) as shown.

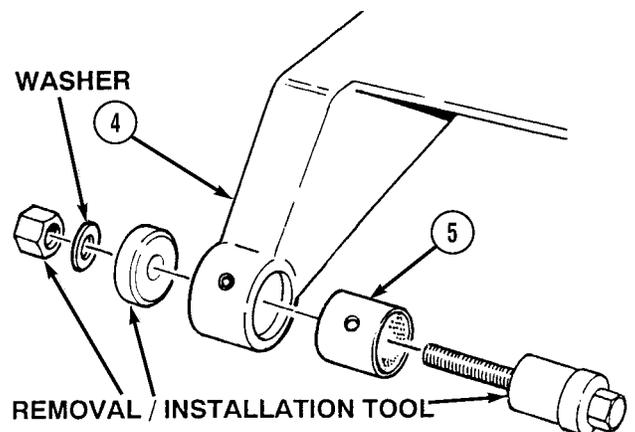

NOTE

If lube fitting hole is restricted by bushing go to step (3) of *b. Disassembly*.

- (3) Check lube fitting hole in hook arm for restrictions.

Direct Support and General Support Maintenance (Cont)

5-24. LOAD HANDLING SYSTEM (LHS) MAIN FRAME REPAIR (CONT).

NOTE

Apply light coat of grease to outer edges of seals prior to installation.

- (4) Install four seals (6) in main frame (4).
- (5) Install two lube fittings (7) in main frame (4).

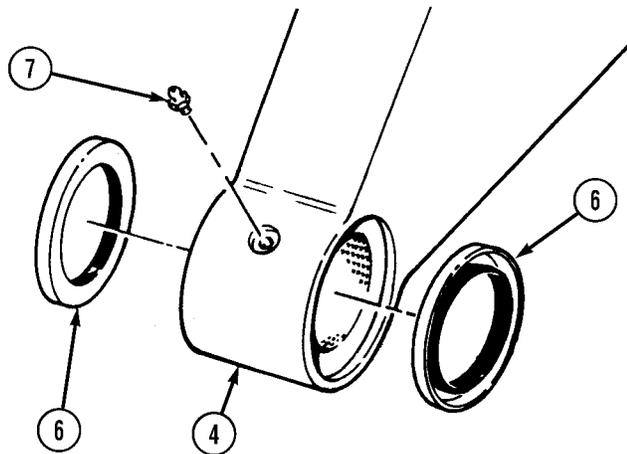

e. Installation.

WARNING

Main frame weighs 1,000 lbs. (454 kg). Attach suitable lifting device prior to installation to prevent possible injury to personnel.

- (1) Attach lifting device to main frame (1).
- (2) With the aid of another soldier and using lifting device, position main frame (1) on truck.

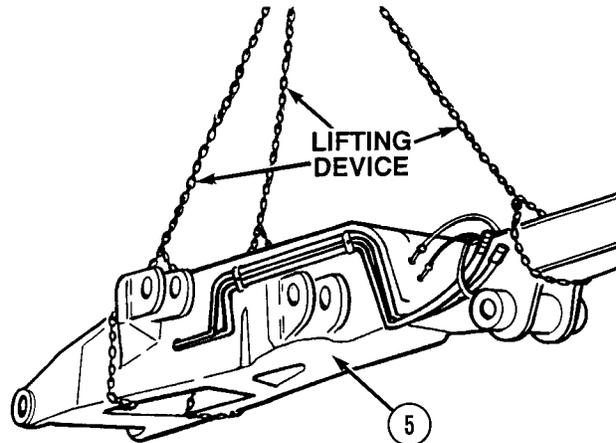

WARNING

Use care when installing retaining rings. Retaining rings are under tension and can act as projectiles when released causing injury to personnel.

NOTE

Coat pivot pin with grease prior to installation.

- (3) With the aid of another soldier, install two pivot pins (2), shims (3), and retaining rings (4) on main frame (1).
- (4) Block main frame (1) up in two places so that front of main frame is 30 to 35 in. (76 to 89 cm) above compression frame where rubber bumpers are mounted.

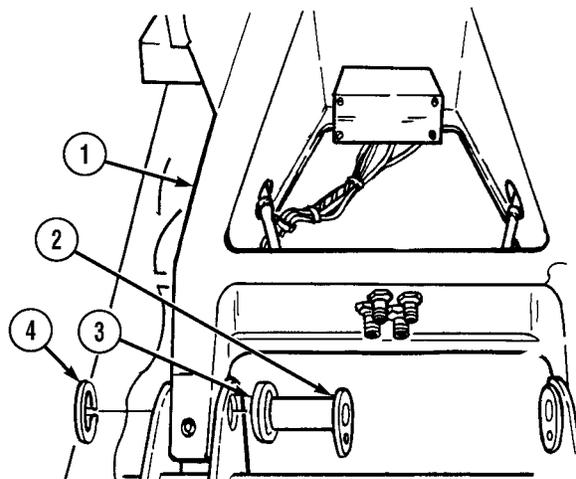

Direct Support and General Support Maintenance (Cont)

- (5) Remove lifting device from main frame (1).

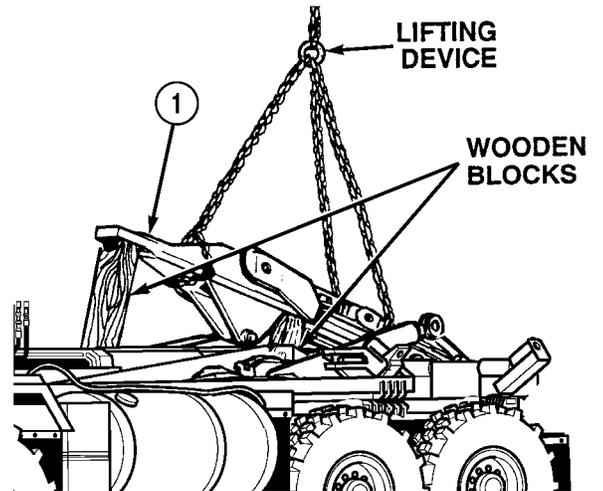

- (6) Install hoses 2881 (5), 2882 (6), 2891 (7), and 2892 (8) on main frame bulkhead fittings (9).
- (7) Install connector (10) on junction box (11).
- (8) Install cable ties (12) on main harness (13).

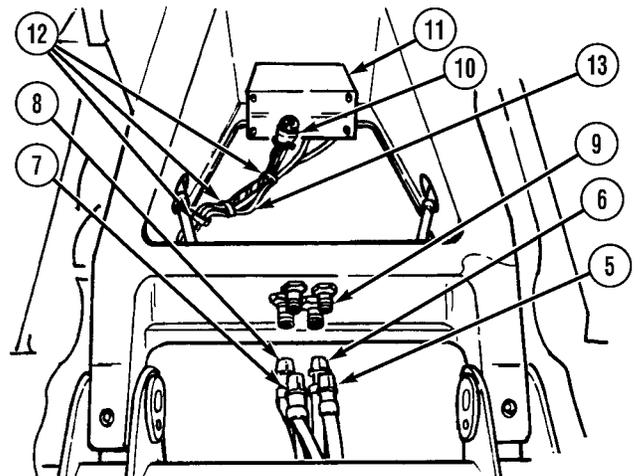

Direct Support and General Support Maintenance (Cont)

5-24. LOAD HANDLING SYSTEM (LHS) MAIN FRAME REPAIR (CONT).

WARNING

Main frame cylinders weigh 325 lbs. (148 kg). Attach suitable lifting device prior to installation to prevent possible injury to personnel.

- (9) Attach lifting device to left main frame cylinder (14).
- (10) Using lifting device, lift main frame cylinder (14) into installation position.

WARNING

Use care when installing retaining rings. Retaining rings are under tension and can act as projectiles when released causing injury to personnel.

- (11) Install pivot pin (15), shim (16), and retaining ring (17) on main frame (1) and main frame cylinder (14).
- (12) Remove lifting device from main frame cylinder (14).
- (13) Repeat Steps (8) through (11) for right main frame cylinder (14).

f. Follow-on Maintenance.

- (1) Install LHS junction box (Para 4-41).
- (2) Install main frame tubes (Para 5-25).
- (3) Install proximity switch (hook arm up) (Para 4-36).
- (4) Install proximity switch (main frame down) (Para 4-37).
- (5) Install hook arm (Para 5-23).
- (6) Connect batteries (TM 9-2320-279-20).
- (7) Remove wheel chocks (TM 9-2320-279-10).

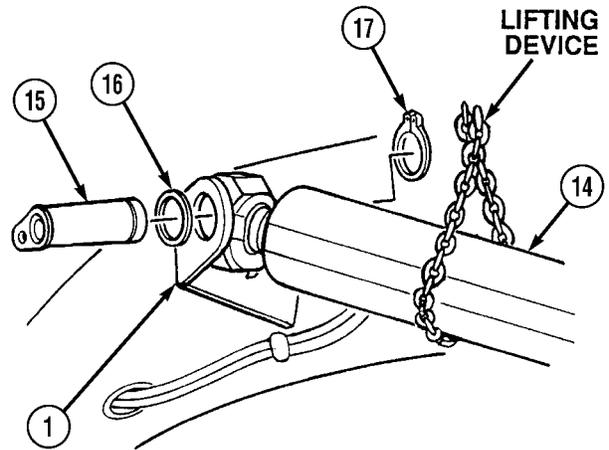

END OF TASK

Direct Support and General Support Maintenance (Cont)

5-25. LOAD HANDLING SYSTEM (LHS) MAIN FRAME TUBE REPLACEMENT.		
This task covers:		
a. Removal	b. Installation	c. Follow-on Maintenance
INITIAL SETUP		
<i>Models</i> M1120	<i>Personnel Required</i> MOS 63W, Wheel vehicle repairer	
<i>Test Equipment</i> None	<i>References</i> None	
<i>Special Tools</i> Tool Kit, General Mechanic's, Item 32, Appendix B Cap and Plug Set, Item 2, Appendix B Lifting Device, Minimum Capacity 2,100 lbs. (953 kg) Wooden Block (2), Appendix H	<i>Equipment Condition</i> <i>TM or Para</i> <i>Condition Description</i> TM 9-2320-279-10 Engine OFF TM 9-2320-279-10 Wheels chocked	
<i>Supplies</i> Cable Ties, Item 4, Appendix F Oil, Hydraulic, Item 12, Appendix F Tags, Identification, Item 19, Appendix F Lockwasher (4), Item 14, Appendix K Lockwasher (6), Item 17, Appendix K Lockwasher (6), Item 18, Appendix K Lockwasher (2), Item 20, Appendix K Packing, Preformed (2), Item 25, Appendix K Ring, Retaining, Item 41, Appendix K	<i>Special Environmental Conditions</i> None	
	<i>General Safety Instructions</i> None	

Direct Support and General Support Maintenance (Cont)

5-25. LOAD HANDLING SYSTEM (LHS) MAIN FRAME TUBE REPLACEMENT (CONT).

a. Removal.

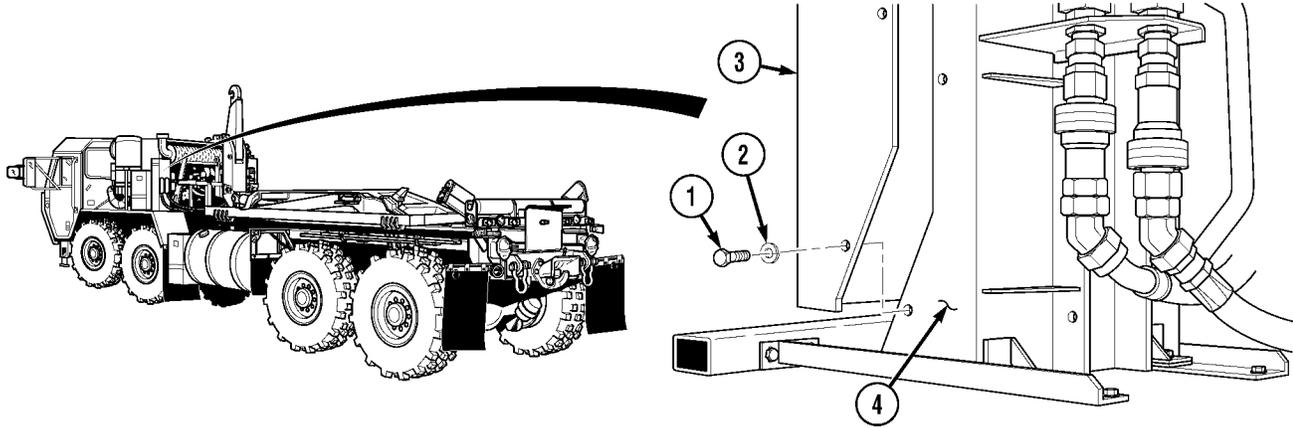

NOTE

Only remove center screw on engine side of LHS main junction box cover.

- (1) Remove four screws (1), lockwashers (2), and LHS main junction box cover (3) from bracket (4). Discard lockwashers.

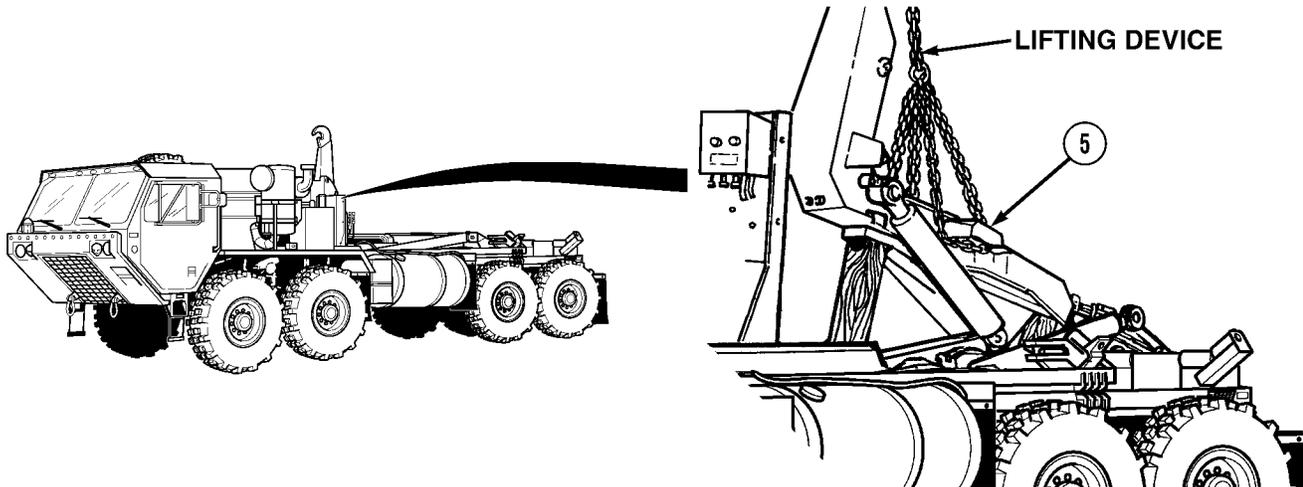

WARNING

Main frame and hook arm combined weight is 2,100 lbs. (953 kg). Hook arm cylinders weigh 210 lbs. (95 kg) each. Attach suitable lifting device prior to removal to prevent possible injury to personnel.

- (2) Attach lifting device to hook arm (5).

Direct Support and General Support Maintenance (Cont)

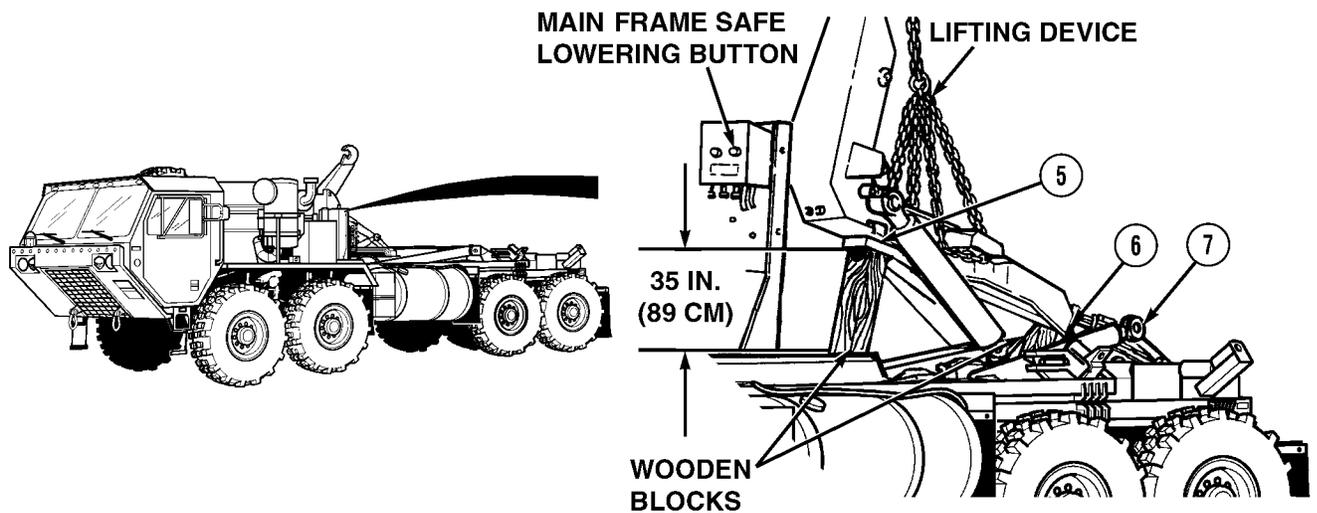
**NOTE**

Main frame tube should be blocked 35 in. (89 cm) above compression frame.

- (3) Turn ENGINE switch to ON position.

CAUTION

Do not allow wooden blocks supporting main frame to fall when main frame is lifted, or damage to equipment may result.

- (4) With the aid of another soldier, press main frame safe lowering button while using lifting device to raise main frame (5).
 (5) Raise main frame (5) hook arm pivot pin (6) above main frame cylinder (7). Block up main frame (5) in two places with wooden blocks.
 (6) Turn ENGINE switch to OFF position.
 (7) Remove lifting device from main frame (5).

Direct Support and General Support Maintenance (Cont)

5-25. LOAD HANDLING SYSTEM (LHS) MAIN FRAME TUBE REPLACEMENT (CONT).

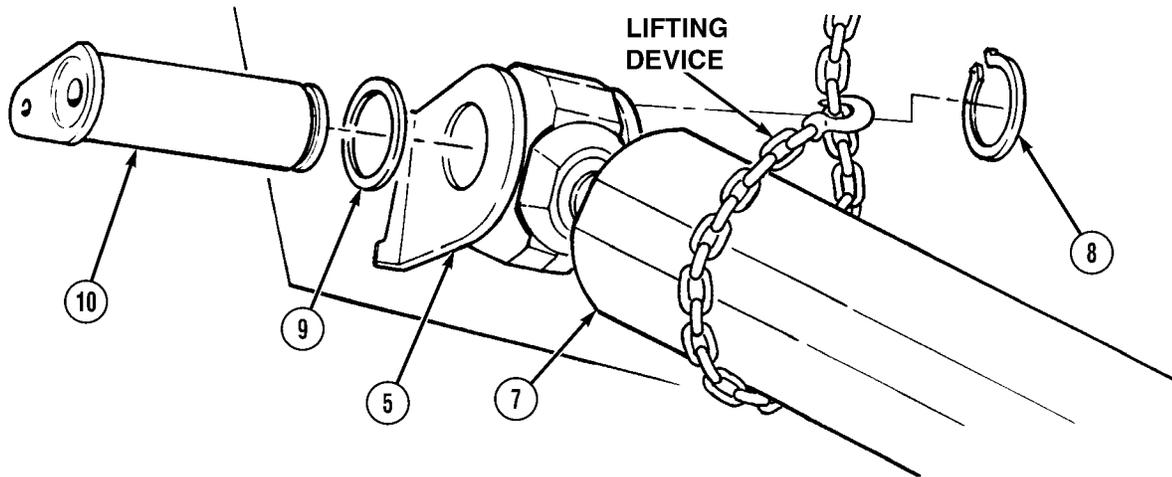

WARNING

Main frame cylinder weighs 325 lbs. (148 kg). Attach suitable lifting device prior to removal to prevent possible injury to personnel.

- (8) Attach lifting device to main frame cylinder (7).

WARNING

Use care when installing retaining rings. Retaining rings are under tension and can act as projectiles when released causing injury to personnel.

- (9) With the aid of another soldier, support main frame cylinder (7) using lifting device and remove retaining ring (8), shim (9), and main frame cylinder pivot pin (10). Lower main frame cylinder out of main frame (5). Discard retaining ring.
- (10) Remove lifting device from main frame cylinder (7).

Direct Support and General Support Maintenance (Cont)

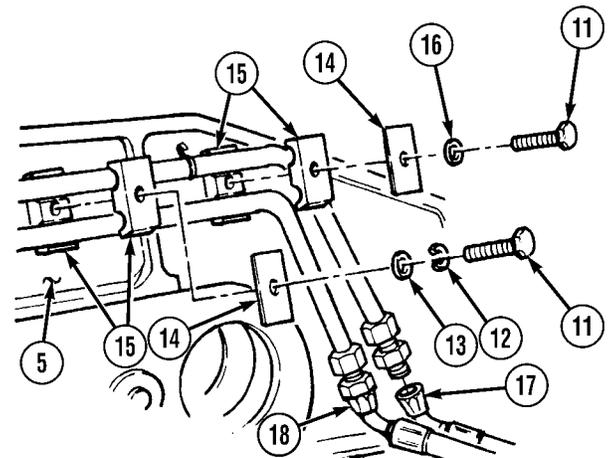
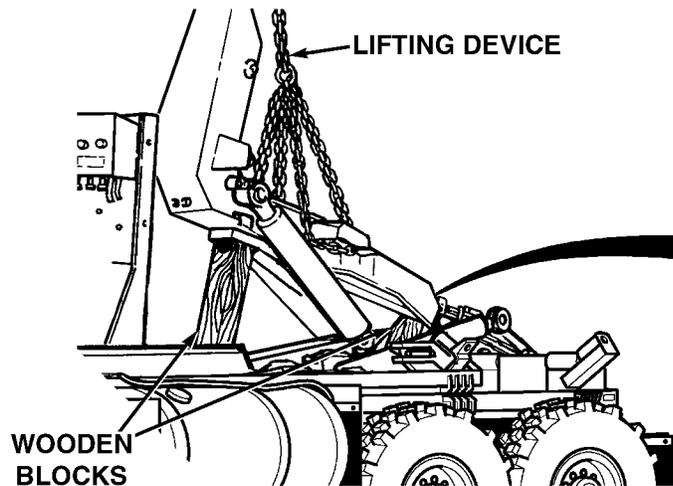

WARNING

The LHS hydraulic system operates at oil pressures up to 1,725 psi (11 894 kPa). Never disconnect any hydraulic line or fitting without first dropping pressure to zero. Failure to comply may result in serious injury or death to personnel.

NOTE

- Tag and mark all hoses prior to removal.
- Cap and plug hydraulic hoses and tubes after removal.
- Remove cable ties as required.

- (11) Remove two screws (11), lockwashers (12), washers (13), cover plates (14), and four clamps (15).
 (12) Remove screw (11), lockwasher (16), cover plate (14), two clamps (15), hose 2891 (17), and hose 2881 (18) from main frame (5).

NOTE

Step (13) applies to tubes on left side only.

- (13) Remove adapter (19), preformed packing (20), spacer (21), compression ring (22), and nut (23) from tube (24). Discard preformed packing.

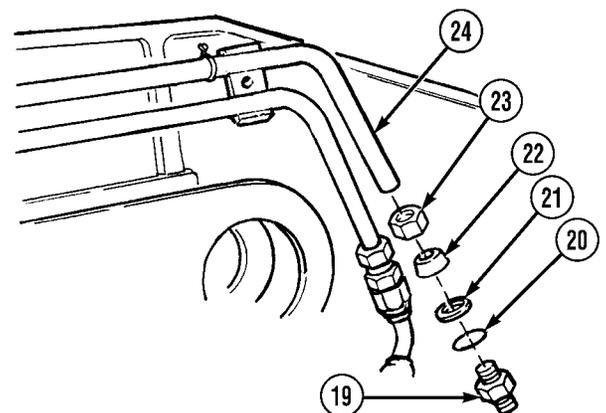

Direct Support and General Support Maintenance (Cont)

5-25. LOAD HANDLING SYSTEM (LHS) MAIN FRAME TUBE REPLACEMENT (CONT).

- (14) Remove two screws (25), lockwasher (26), and proximity switch (27) with clamp. Do not separate clamp halves.

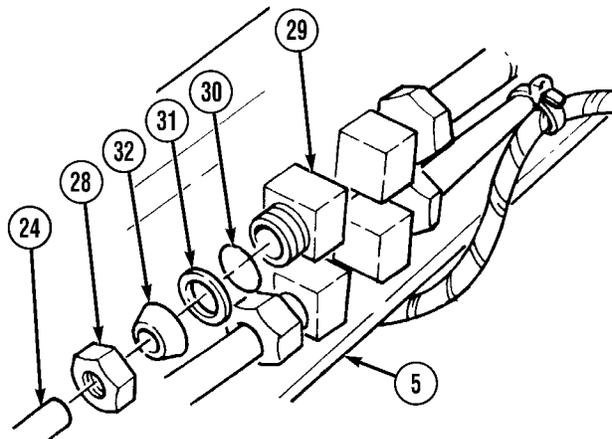
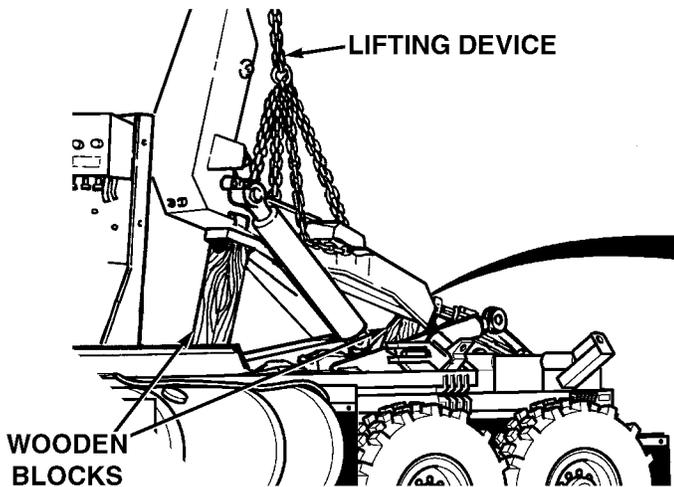
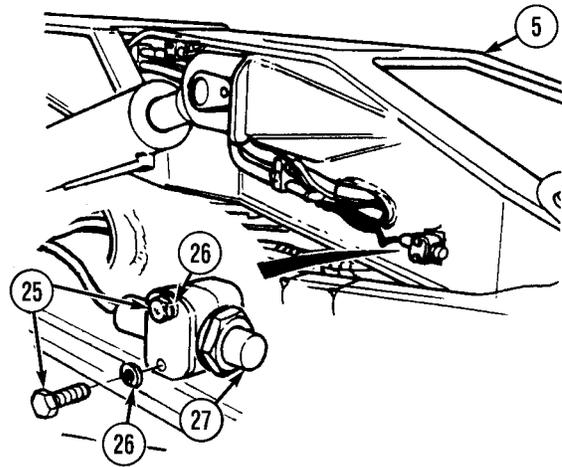

NOTE

Remove cable ties from tube as required.

- (15) Remove tube nut (28) from bulkhead (29) at inside rear of main frame (5).
 (16) Pull tube (24) from bulkhead (29), remove preformed packing (30), spacer (31), compression ring (32), and nut (28) from tube and remove tube from main frame (5). Discard preformed packing.

Direct Support and General Support Maintenance (Cont)

b. Installation.

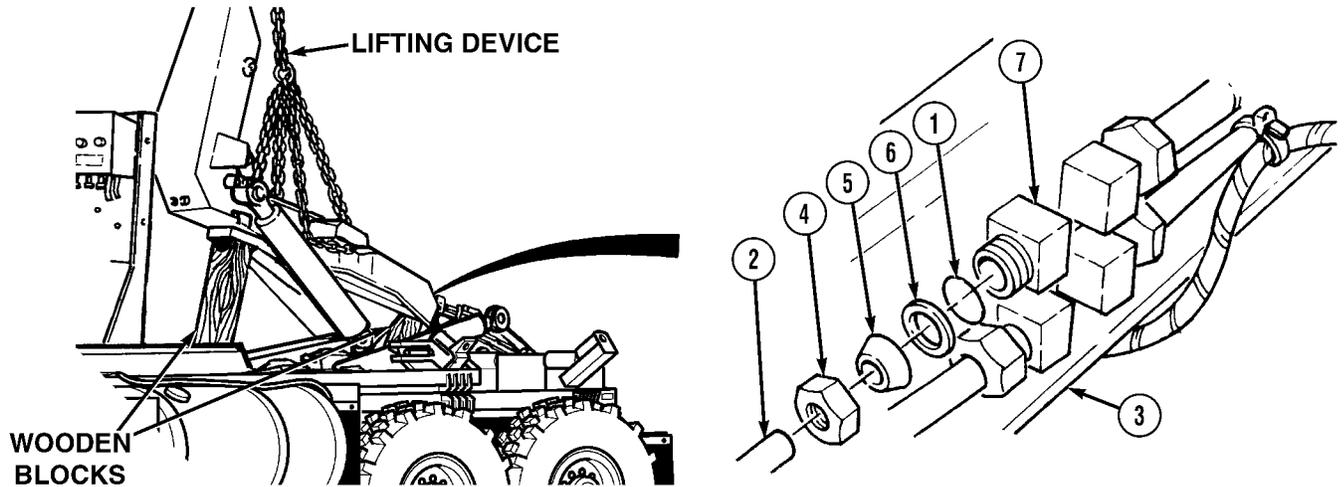

- (1) Apply hydraulic oil to preformed packing (1).
- (2) Position tube (2) through main frame (3) and install nut (4), compression ring (5), spacer (6), and preformed packing (1) on tube (2).

NOTE

Install cable ties as required to secure harness to tube.

- (3) Insert tube (2) into bulkhead (7) and install nut (4) on bulkhead.
- (4) Install proximity switch (8) with clamps using two screws (9) and lockwashers (10).

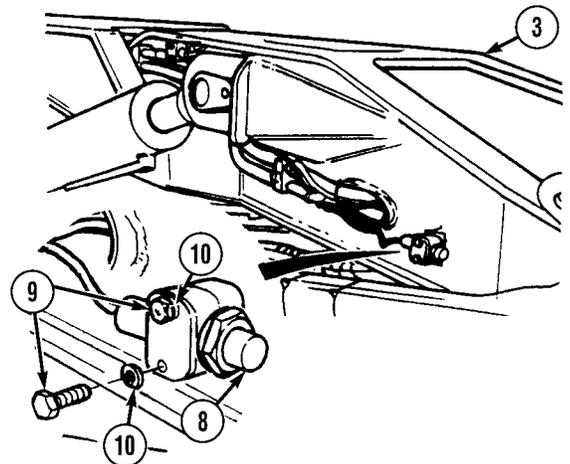

Direct Support and General Support Maintenance (Cont)

5-25. LOAD HANDLING SYSTEM (LHS) MAIN FRAME TUBE REPLACEMENT (CONT).

- (5) Apply hydraulic oil to preformed packing (11).
- (6) Install tube nut (12), compression ring (13), spacer (14), preformed packing (11), and adapter (15) on tube (2).

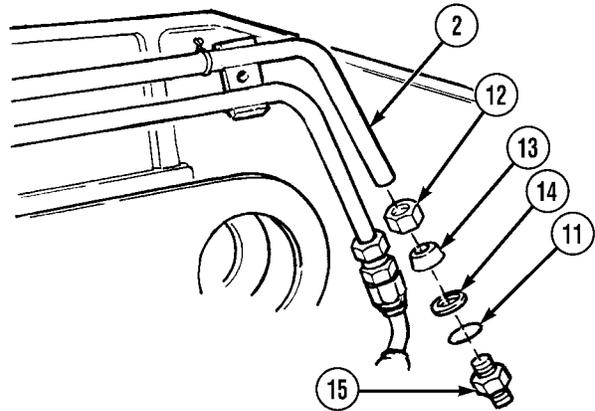

- (7) Install four clamps (16), two cover plates (17), washers (18), lockwashers (19), and screws (20).
- (8) Install hose 2891 (21), hose 2881 (22), two clamps (16), cover plate (17), lockwasher (18), and screw (20) on main frame (3).

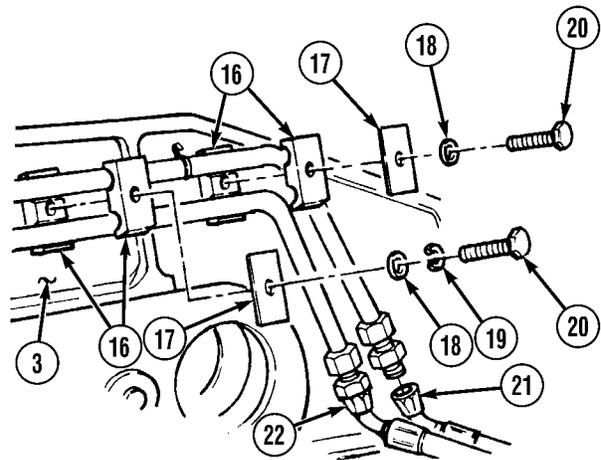

Direct Support and General Support Maintenance (Cont)

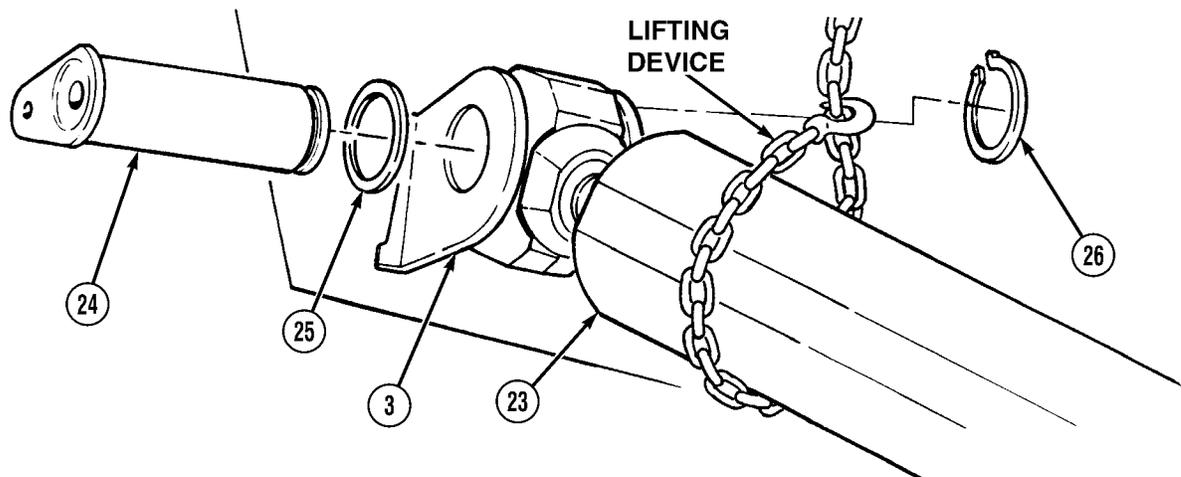
**WARNING**

Main frame cylinder weighs 325 lbs. (148 kg). Attach suitable lifting device prior to installation to prevent possible injury to personnel.

- (9) Attach lifting device to main frame cylinder (3).

WARNING

Use care when removing retaining rings. Retaining rings are under tension and can act as projectiles when released causing injury to personnel.

NOTE

It may be necessary to use soft faced hammer to aline cylinder rod end with clevis on main frame.

- (10) With the aid of another soldier and using lifting device, lift main frame cylinder (23) into main frame (3) and install pivot pin (24), shim (25), and retaining ring (26).
 (11) Remove lifting device from main frame cylinder (23).

Direct Support and General Support Maintenance (Cont)

5-25. LOAD HANDLING SYSTEM (LHS) MAIN FRAME TUBE REPLACEMENT (CONT).

WARNING

Main frame and hook arm combined weight is 2,100 lbs. (953 kg). Hook arm cylinders weigh 210 lbs. (95 kg) each. Attach suitable lifting device prior to installation to prevent possible injury to personnel.

(12) Attach lifting device to main frame (3).

CAUTION

Do not allow wooden blocks supporting main frame to fall when main frame is lifted, or damage to equipment may result.

- (13) With the aid of another soldier, press main frame safe lowering button while using lifting device to raise main frame (3).
- (14) Remove wooden blocks and then lower main frame (3).
- (15) Remove lifting device from main frame (3).
- (16) Install LHS control box cover (27), four lockwashers (28), and screws (29) on bracket (30).

c. Follow-on Maintenance Remove wheel chocks (TM 9-2320-279-10).

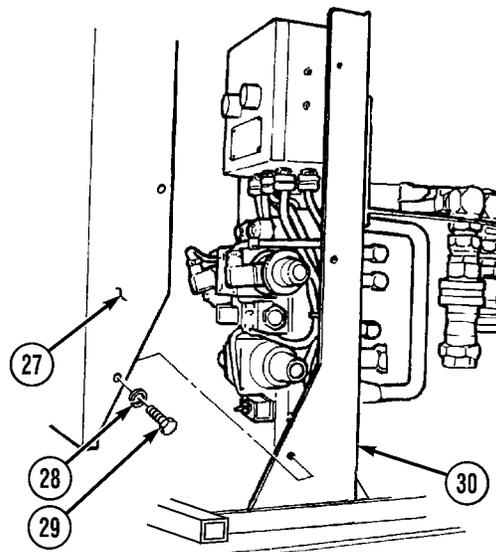
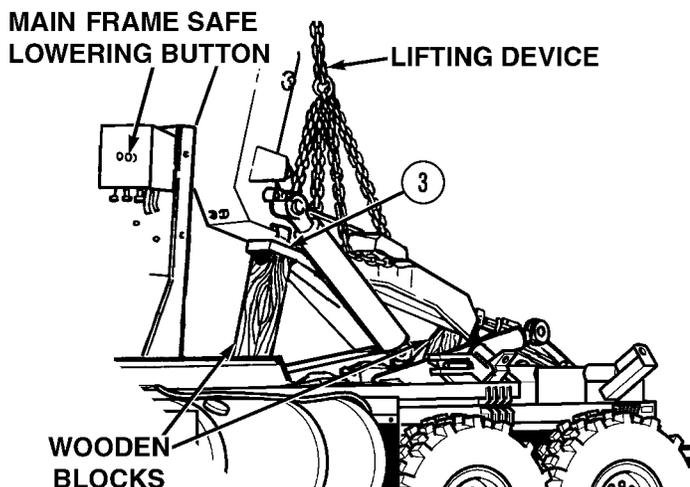

END OF TASK

Direct Support and General Support Maintenance (Cont)

5-26. LOAD HANDLING SYSTEM (LHS) COMPRESSION FRAME REPAIR.													
This task covers:													
a. Removal	c. Assembly												
b. Disassembly	d. Installation												
e. Follow-on Maintenance													
INITIAL SETUP													
<p><i>Models</i> M1120</p> <p><i>Test Equipment</i> None</p> <p><i>Special Tools</i> Tool Kit, General Mechanic's, Item 32, Appendix B Cap and Plug Set, Item 2, Appendix B Wrench, Combination 1-1/8 in., Item 37, Appendix B Wrench, Combination 1-1/4 in., Item 38, Appendix B Wrench, Combination 1-5/8 in., Item 40, Appendix B Wrench, Combination, 1-13/16 in., Item 41, Appendix B Wrench Set, Socket 3/4 in. Drive, Item 45, Appendix B Wrench, Torque (0-600 lb-ft. [0-814 N•m]), Item 49, Appendix B Lifting Device, Minimum Capacity 800 lbs. (363 kg)</p> <p><i>Supplies</i> Oil, Hydraulic, Item 12, Appendix F Sealing Compound, Item 16, Appendix F Tags, Identification, Item 19, Appendix F Locknut (6), Item 3, Appendix K Locknut (2), Item 5, Appendix K Locknut (6), Item 9, Appendix K Lockwasher (8), Item 17, Appendix K Lockwasher (3), Item 20, Appendix K Lockwasher (6), Item 21, Appendix K</p>	<p><i>Supplies - Continued</i> Lockwasher (16), Item 22, Appendix K Washer, Spring (48), Item 46, Appendix K Packing, Preformed (4), Item 26, Appendix K Packing, Preformed (2), Item 27, Appendix K</p> <p><i>Personnel Required</i> MOS 63W, Wheel vehicle repairer</p> <p><i>References</i> None</p> <p><i>Equipment Condition</i></p> <table border="0"> <thead> <tr> <th style="text-align: left;"><i>TM or Para</i></th> <th style="text-align: left;"><i>Condition Description</i></th> </tr> </thead> <tbody> <tr> <td>TM 9-2320-279-10</td> <td>Engine OFF</td> </tr> <tr> <td>TM 9-2320-279-10</td> <td>Wheels chocked</td> </tr> <tr> <td>Para 5-19</td> <td>LHS main wire harness removed</td> </tr> <tr> <td>Para 5-24</td> <td>LHS main frame removed</td> </tr> <tr> <td>Para 5-40</td> <td>LHS main cylinders removed</td> </tr> </tbody> </table> <p><i>Special Environmental Conditions</i> None</p> <p><i>General Safety Instructions</i> None</p>	<i>TM or Para</i>	<i>Condition Description</i>	TM 9-2320-279-10	Engine OFF	TM 9-2320-279-10	Wheels chocked	Para 5-19	LHS main wire harness removed	Para 5-24	LHS main frame removed	Para 5-40	LHS main cylinders removed
<i>TM or Para</i>	<i>Condition Description</i>												
TM 9-2320-279-10	Engine OFF												
TM 9-2320-279-10	Wheels chocked												
Para 5-19	LHS main wire harness removed												
Para 5-24	LHS main frame removed												
Para 5-40	LHS main cylinders removed												

Direct Support and General Support Maintenance (Cont)

5-26. LOAD HANDLING SYSTEM (LHS) COMPRESSION FRAME REPAIR (CONT).

a. Removal.

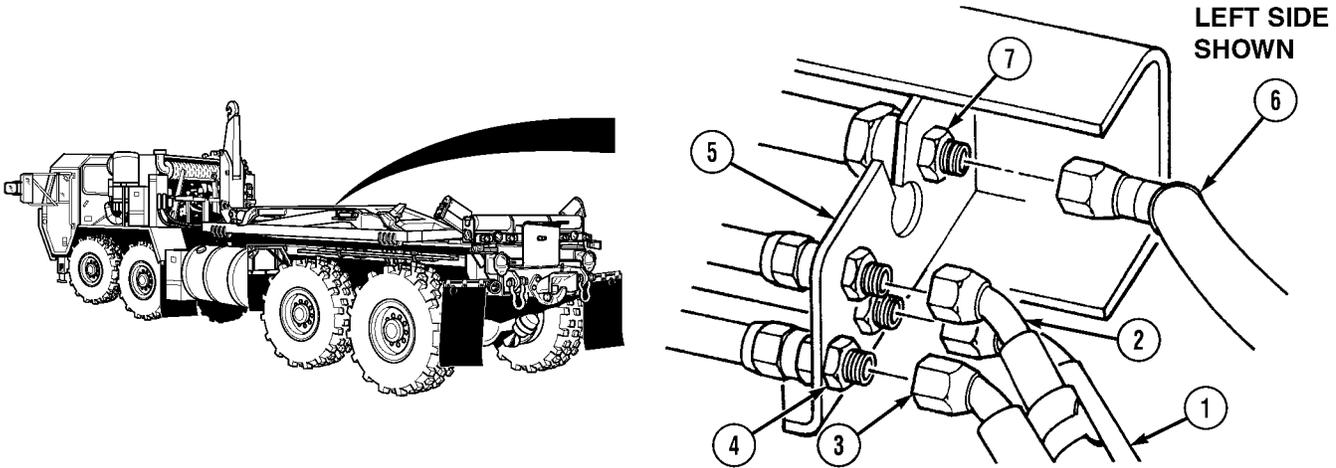

WARNING

The LHS hydraulic system operates at oil pressures up to 1,725 psi (11 894 kPa). Never disconnect any hydraulic line or fitting without first dropping pressure to zero. Failure to comply may result in serious injury or death to personnel.

NOTE

- Tag and mark all hoses prior to removal.
- Left side and right side procedures are the same. Left side is shown. Disconnect hoses 2588, 2888, 2889, and 2892 on the right side.
- Cap and plug all hoses and tubes prior to removal.

- (1) Disconnect hoses 2887 (1), 2666 (2), and 2890 (3) from three adapters (4) at front of compression frame (5).
- (2) Disconnect hose 2891 (6) from adapter (7) at front of compression frame (5).

Direct Support and General Support Maintenance (Cont)

WARNING

Compression frame weighs 800 lbs. (363 kg). Attach suitable lifting device prior to removal to prevent possible injury to personnel.

NOTE

Left and right side screws are removed the same way. Left side shown.

- (3) Attach lifting device to compression frame (5).
- (4) Remove three front screws (8), washers (9), 24 spring washers (10), and three locknuts (11) from compression frame (5) and truck. Discard spring washers and locknuts.
- (5) Remove three rear locknuts (12) and screws (13) from compression frame (5) and truck. Discard locknuts.
- (6) Repeat Steps (4) through (5) for right side.
- (7) Using lifting device, lift compression frame (5) off truck.
- (8) Remove eight compression frame spacers (14).
- (9) Remove lifting device from compression frame (5).

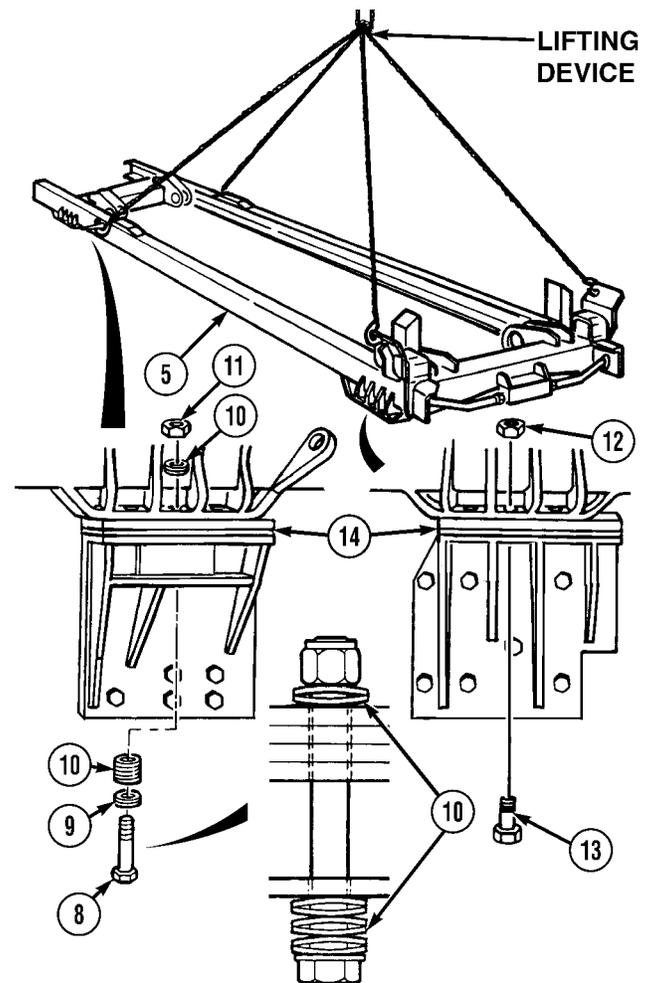

b. Disassembly.

NOTE

Left and right side clamps are removed the same way. Left side shown.

- (1) Remove eight screws (1) and lockwashers (2), sixteen washers (3), four cover plates (4), and eight tube clamp halves (5) from left side compression frame tube (6). Discard lockwashers.

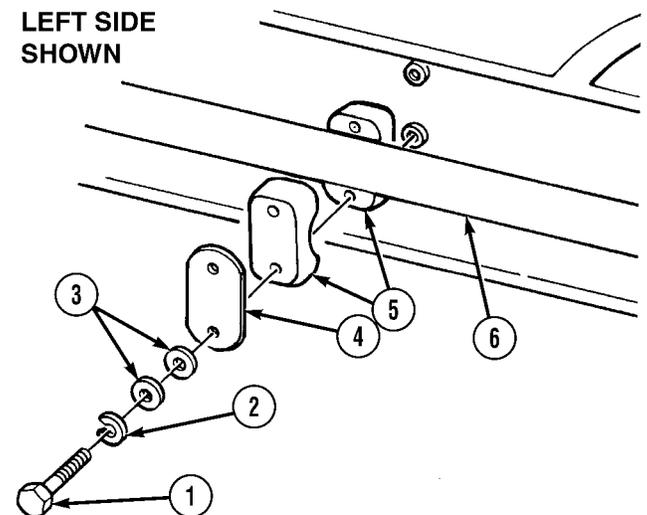

Direct Support and General Support Maintenance (Cont)

5-26. COMPRESSION FRAME REPAIR (CONT).

NOTE

- Tag and mark all hoses prior to removal.
 - Left side and right side procedures are the same. Left side is shown.
 - Cap and plug all hoses and tubes after removal.
 - Disconnect hoses 2588, 2888, and 2889 on the right side.
- (2) Disconnect hoses 2887 (7), 2666 (8), and 2890 (9) from three adapters (10) at front of compression frame (11).
 - (3) Remove three nuts (12), lockwashers (13), and adapters (10) from compression frame (11). Discard lockwashers.
 - (4) Remove three screws (14), lockwashers (15), and washers (16) from diverter manifold (17). Discard lockwashers.
 - (5) Remove two nuts (18) and compression frame tubes (6) from diverter manifold (17).
 - (6) Remove two fittings (19) and preformed packings (20) from diverter manifold (17). Discard preformed packings.
 - (7) Remove two preformed packings (21), spacers (22), compression rings (23), and nuts (18) from compression frame tubes (6). Discard preformed packings.

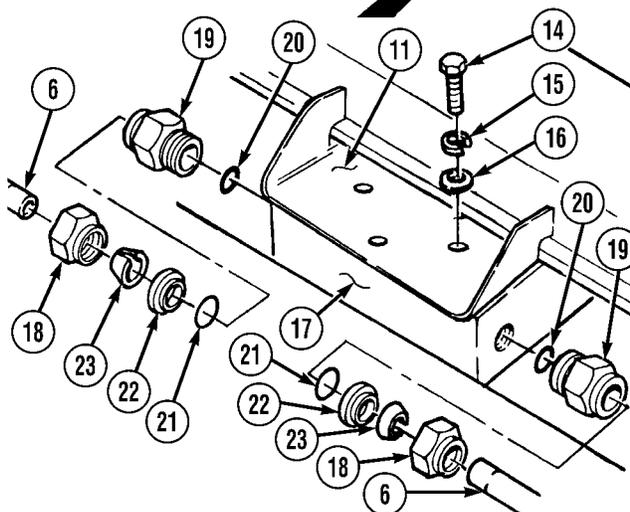
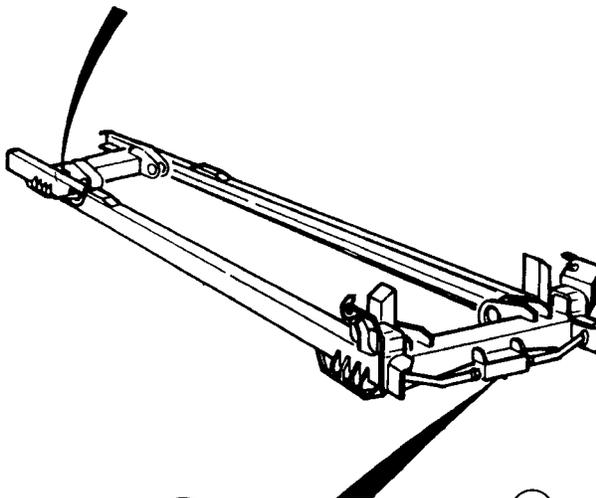
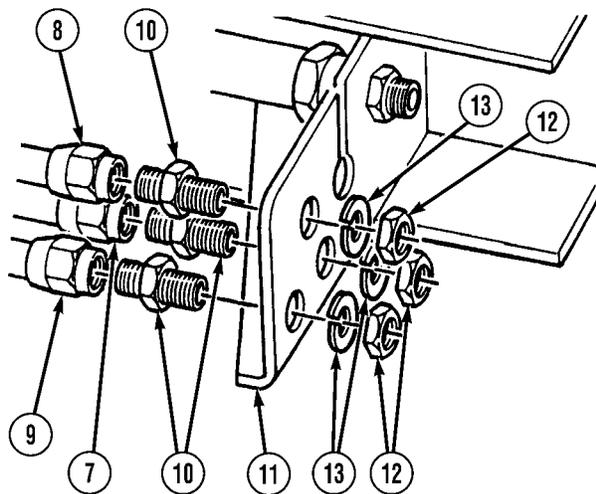

Direct Support and General Support Maintenance (Cont)

- (8) Remove left side compression frame nut (24) and left side compression frame tube (6) from bulkhead union (25).
- (9) Remove preformed packing (26), spacer (27), compression ring (28), and nut (24) from left side compression frame tube (6). Discard preformed packing.
- (10) Remove nut (29) and bulkhead union (25) from compression frame (11).
- (11) Repeats steps (1) through (10) for right side.

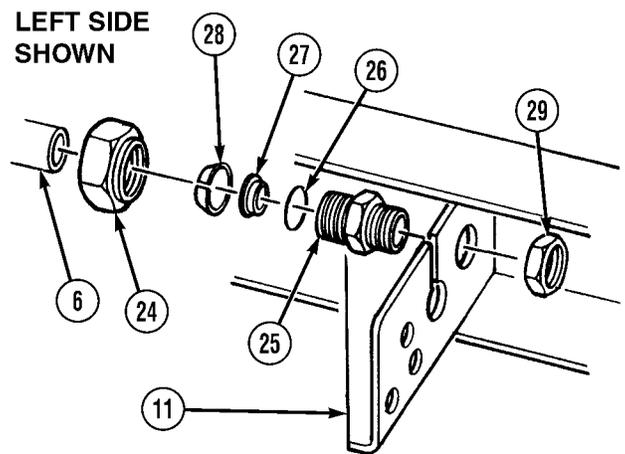

- (12) Remove locknut (30) and three rubber bumpers (31) from compression frame (11). Discard locknut.

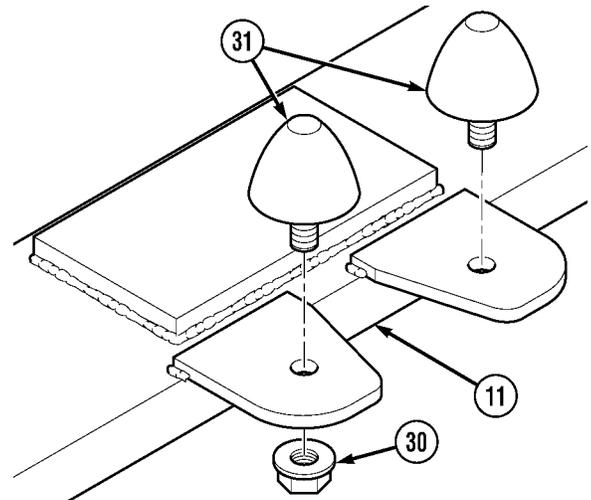

Direct Support and General Support Maintenance (Cont)

5-26. COMPRESSION FRAME REPAIR (CONT).

c. Assembly.

WARNING

Adhesives, solvents, and sealing compounds can burn easily, can give off harmful vapors, and are harmful to skin and clothing. To avoid injury or death, keep away from open fire and use in a well-ventilated area. If adhesive, solvent, or sealing compound gets on skin or clothing, wash immediately with soap and water.

- (1) Coat threads of three rubber bumpers (1) with sealing compound.
- (2) Install three rubber bumpers (1) in compression frame (2).
- (3) Install locknut (3) on rubber bumper (1).
- (4) Install bulkhead union (4) with nut (5) in compression frame (2).

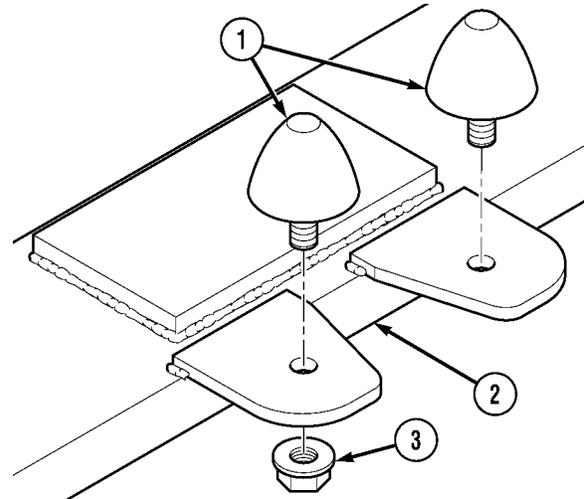

CAUTION

Ensure correct preformed packing is installed on fitting or damage to packing will result.

- (5) Apply hydraulic oil to preformed packing (6).
- (6) Install nut (7), compression ring (8), spacer (9), and preformed packing (6) on left side compression frame tube (10).
- (7) Install left side compression frame tube (10) in bulkhead union (4) and slide preformed packing (6) with spacer (9) and compression ring (8) into bulkhead union (4).
- (8) Install nut (7) on bulkhead union (4).

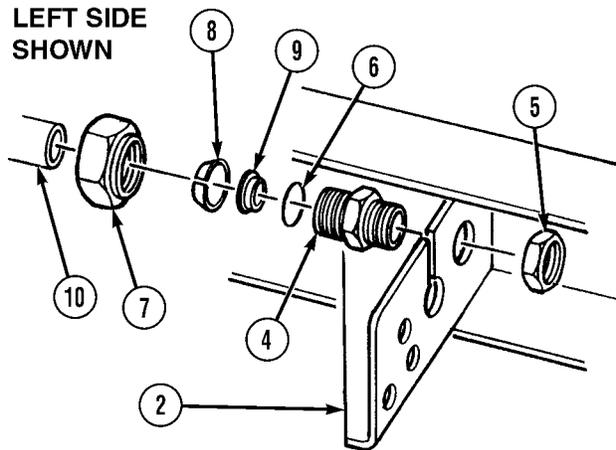

Direct Support and General Support Maintenance (Cont)

- (9) Apply hydraulic oil to two preformed packings (11).
- (10) Install two nuts (12), compression rings (13), spacers (14), and preformed packings (11) on compression frame tubes (10).

CAUTION

Ensure correct preformed packing is installed on fitting or damage to packing will result.

- (11) Apply hydraulic oil to two preformed packings (15) and install on fittings (16).

- (12) Install two fittings (16) on diverter manifold (17).
- (13) Install two compression frame tubes (10) in diverter manifold (17).
- (14) Install diverter manifold (17) on compression frame (2) with three washers (18), lockwashers (19), and screws (20).

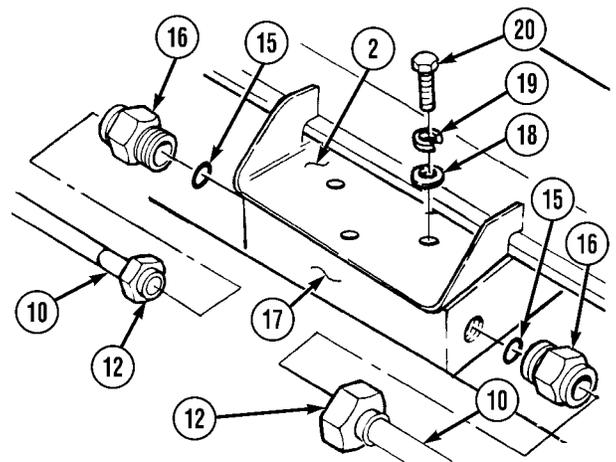
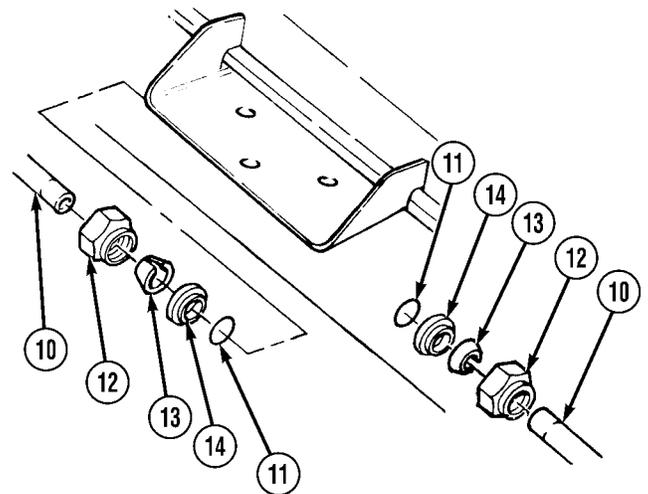

Direct Support and General Support Maintenance (Cont)

5-26. COMPRESSION FRAME REPAIR (CONT).

NOTE

Repeat Steps (15) and (16) for right side hoses 2588, 2888 and 2889.

- (15) Install three adapters (21) at front of compression frame (2) with three lockwashers (22) and nuts (23).
- (16) Install hoses 2887 (24), 2666 (25), and 2890 (26) on three adapters (21).

WARNING

Adhesives, solvents, and sealing compounds can burn easily, can give off harmful vapors, and are harmful to skin and clothing. To avoid injury or death, keep away from open fire and use in a well-ventilated area. If adhesive, solvent, or sealing compound gets on skin or clothing, wash immediately with soap and water.

- (17) Apply sealing compound to threads of screws (27).
- (18) Install eight tube clamp halves (28) and four cover plates (29) on left side compression frame tube (10) with sixteen washers (30), eight lockwashers (31), and screws (27).

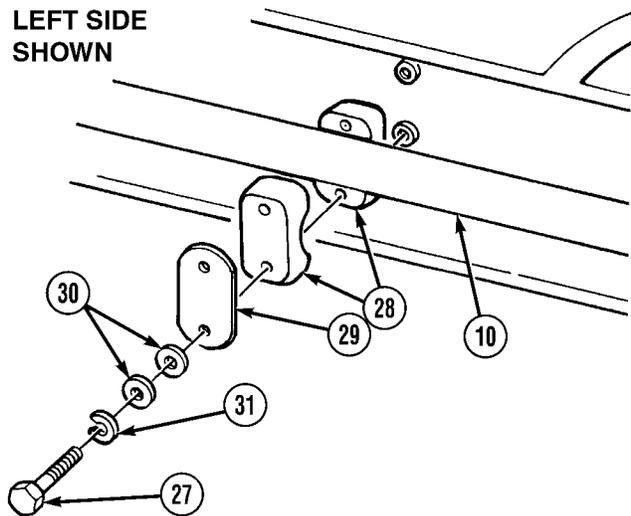
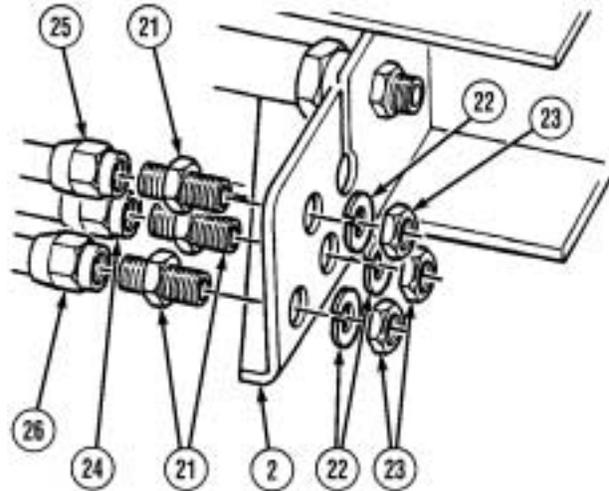

Direct Support and General Support Maintenance (Cont)

d. Installation.

WARNING

Compression frame weighs 800 lbs. (363 kg). Attach suitable lifting device prior to removal to prevent possible injury to personnel.

- (1) Attach lifting device to compression frame (1).
- (2) Install eight compression frame spacers (2).
- (3) Using lifting device, lower compression frame (1) onto truck and position for installation.

NOTE

Left and right side screws are installed the same way. Left side is shown.

- (4) Position three screws (3) and locknuts (4) on each side of compression frame (1) and truck.

WARNING

Adhesives, solvents, and sealing compounds can burn easily, can give off harmful vapors, and are harmful to skin and clothing. To avoid injury or death, keep away from open fire and use in a well-ventilated area. If adhesive, solvent, or sealing compound gets on skin or clothing, wash immediately with soap and water.

NOTE

Install spring washers in pairs with no two pairs in the same direction.

- (5) Apply sealing compound on threads of three screws (5).
- (6) Install washer (6) and six spring washers (7) on three screws (5).
- (7) Position three front screws (5) with washers (6) and spring washers (7) up through truck and compression frame (1), and then install two spring washers (7) and locknut (8) on screw (5).
- (8) Repeat steps (4) through (7) for right side.
- (9) Tighten locknuts (8) to 75 lb-ft. (102 N•m).
- (10) Tighten locknuts (4) to 410 lb-ft. (556 N•m).
- (11) Repeat steps (8) and (9) for right side.
- (12) Remove lifting device from compression frame (1).

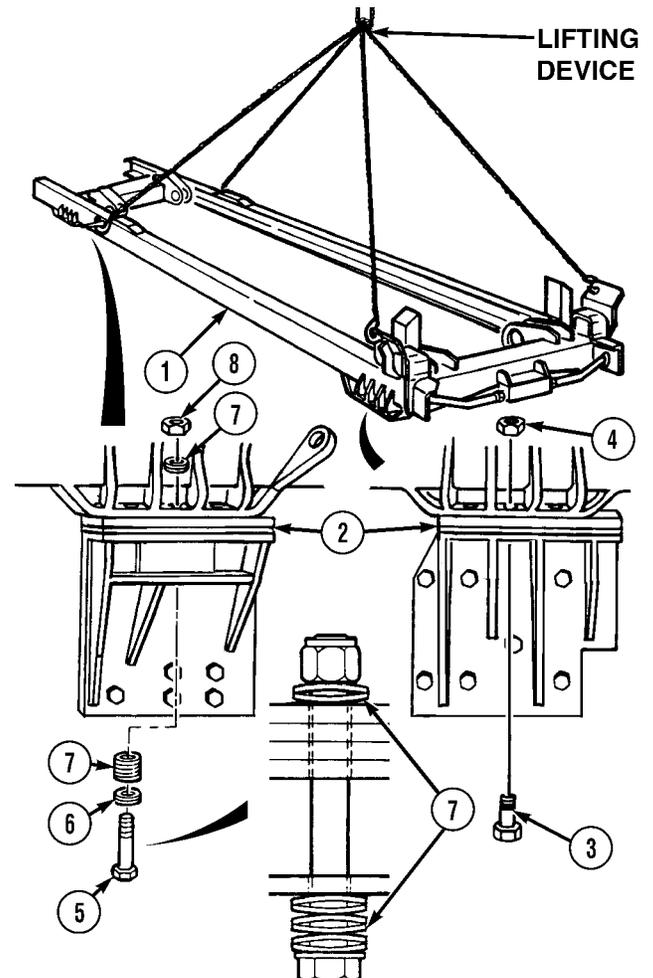

Direct Support and General Support Maintenance (Cont)

5-26. COMPRESSION FRAME REPAIR (CONT).

- (13) Install hose 2891 (9) on bulkhead union (10).
- (14) Install hoses 2887 (11), 2666 (12), and 2890 (13) on three adapters (14) at front of compression frame (1).

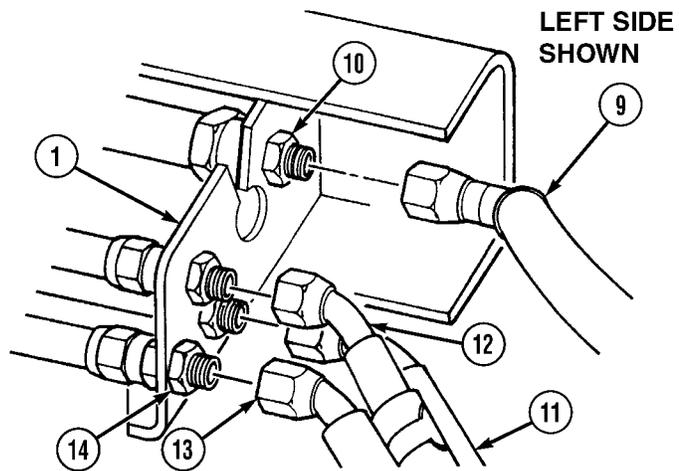

e. Follow-on Maintenance.

- (1) Install main frame (Para 5-24).
- (2) Install LHS main wire harness (Para 5-19).
- (3) Install LHS main cylinders (Para 5-40).
- (4) Remove wheel chocks (TM 9-2320-279-10).

END OF TASK

Direct Support and General Support Maintenance (Cont)

5-27. LOAD HANDLING SYSTEM (LHS) MOUNTING BRACKET REPLACEMENT.

This task covers:

- | | |
|---|--|
| a. Rear Mounting Bracket Removal | e. Right Front Mounting Bracket Removal |
| b. Rear Mounting Bracket Installation | f. Right Front Mounting Bracket Installation |
| c. Left Front Mounting Bracket Removal | g. Follow-on Maintenance |
| d. Left Front Mounting Bracket Installation | |

INITIAL SETUP

Models

M1120

References

None

Test Equipment

None

Equipment Condition

<i>TM or Para</i>	<i>Condition Description</i>
TM 9-2320-279-10	Engine OFF
TM 9-2320-279-10	Wheels chocked
Para 5-26	Compression frame removed

Special Tools

Tool Kit, General Mechanic's, Item 32, Appendix B

Special Environmental Conditions

None

Supplies

Locknut (27) Item 1, Appendix K

General Safety Instructions

None

Personnel Required

MOS 63W, Wheel vehicle repairer

Direct Support and General Support Maintenance (Cont)

5-27. LOAD HANDLING SYSTEM (LHS) MOUNTING BRACKET REPLACEMENT (CONT).

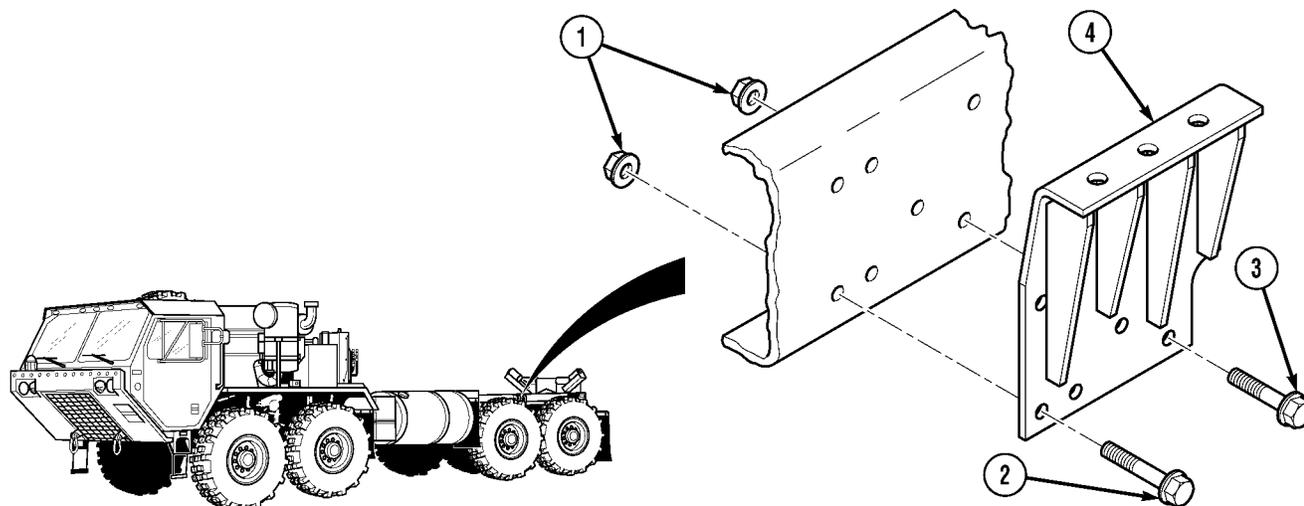

a. Rear Mounting Bracket Removal.

NOTE

Both rear mounting brackets are removed the same way, rear left is shown.

- (1) Remove seven locknuts (1), four 2.75 in. (70 mm) screws (2), three 2.50 in. (63.5 mm) screws (3), and rear mounting bracket (4). Discard locknuts.

b. Rear Mounting Bracket Installation.

- (1) Install rear mounting bracket (4) with four 2.75 in. (70 mm) screws (2), three 2.50 in. (63.5 mm) screws (3), and seven locknuts (1).
- (2) Tighten locknuts.

Direct Support and General Support Maintenance (Cont)

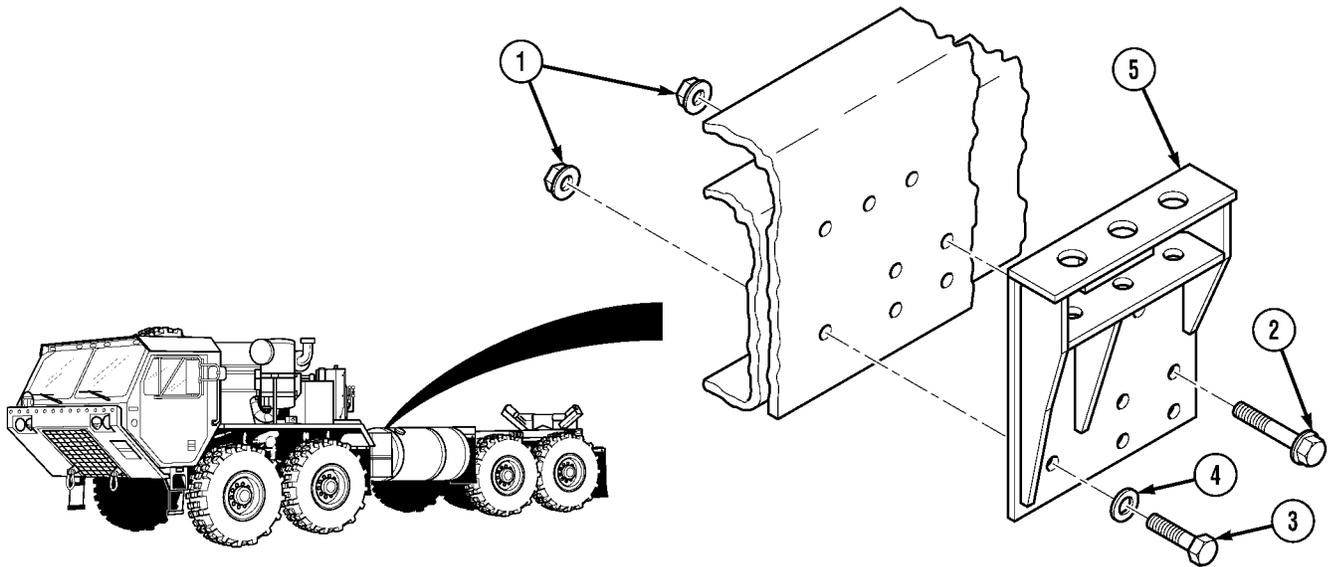

c. Left Front Mounting Bracket Removal.

- (1) Remove eight locknuts (1), four 2.75 in. (70 mm) screws (2), four 2 in. (51 mm) screws (3), four washers (4), and left front mounting bracket (5).

d. Left Front Mounting Bracket Installation.

- (1) Install left front mounting bracket (5) with four 2 in. (51 mm) screws (3), four washers (4), four 2.75 in. (70 mm) screws (2), and eight locknuts (1).
- (2) Tighten locknuts.

Direct Support and General Support Maintenance (Cont)

5-27. LOAD HANDLING SYSTEM (LHS) MOUNTING BRACKET REPLACEMENT (CONT).

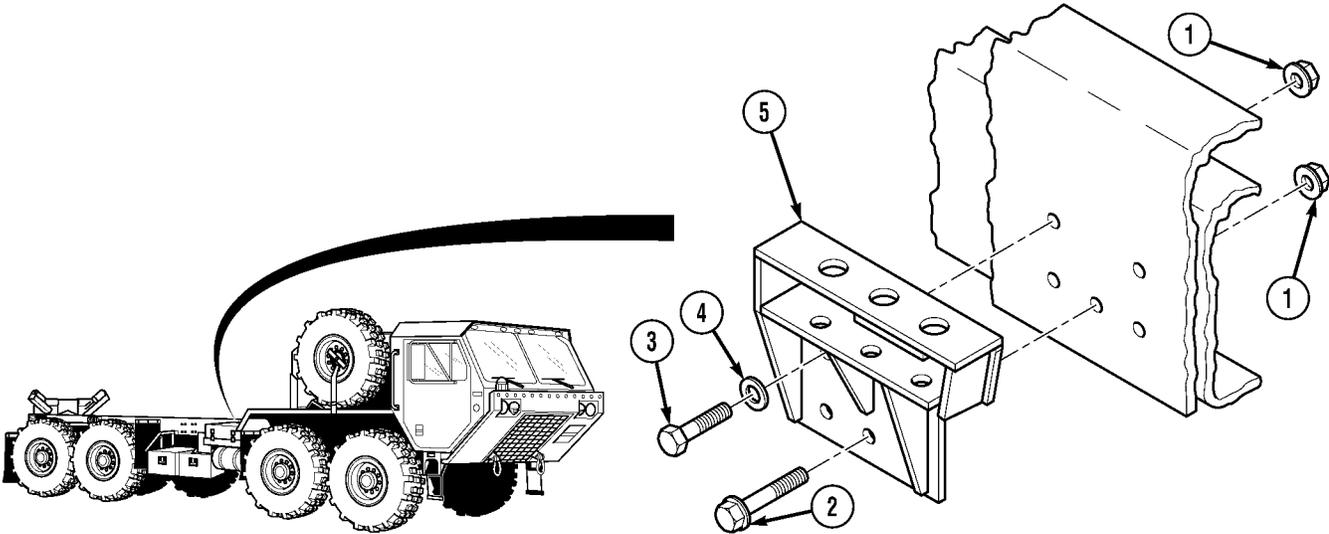

e. Right Front Mounting Bracket Removal.

- (1) Remove five locknuts (1), three screws (2), two screws (3), two washers (4), and right front mounting bracket (5).

f. Right Front Mounting Bracket Installation.

- (1) Install right front mounting bracket (5), three screws (2), two washers (4), two screws (3), and five locknuts (1).
- (2) Tighten locknuts.

g. Follow-on Maintenance.

- (1) Install compression frame (Para 5-26).
- (2) Remove wheel chocks (TM 9-2320-279-10).

END OF TASK

Organizational Maintenance Instructions (Cont)

5-27.1 LOAD HANDLING SYSTEM (LHS) REAR ROLLER ASSEMBLY MOUNTING BRACKET REPLACEMENT.

This task covers:

- a. Rear Mounting Bracket Removal
- b. Rear Mounting Bracket Installation
- c. Follow-on Maintenance

INITIAL SETUP

Models

M1120

Test Equipment

None

Special Tools

Tool Kit, General Mechanic's Automotive, Item 33, Appendix B

Supplies

Locknut (27), Item 1, Appendix K

Personnel Required

MOS 63W, Wheel vehicle repairer

References

None

Equipment Condition

TM or Para

Condition Description

TM 9-2320-279-10 Engine OFF

TM 9-2320-279-10 Wheels chocked

TM 9-2320-279-20 Rear mud flap removed

TM 9-2320-279-20 Rear composite light removed

Para 4-43 Rear marker light assembly removed

Para 4-48 Rear roller assembly removed

Special Environmental Conditions

None

General Safety Instructions

None

Organizational Maintenance Instructions (Cont)

5-27.1 LOAD HANDLING SYSTEM (LHS) REAR ROLLER ASSEMBLY MOUNTING BRACKET REPLACEMENT (CONT).

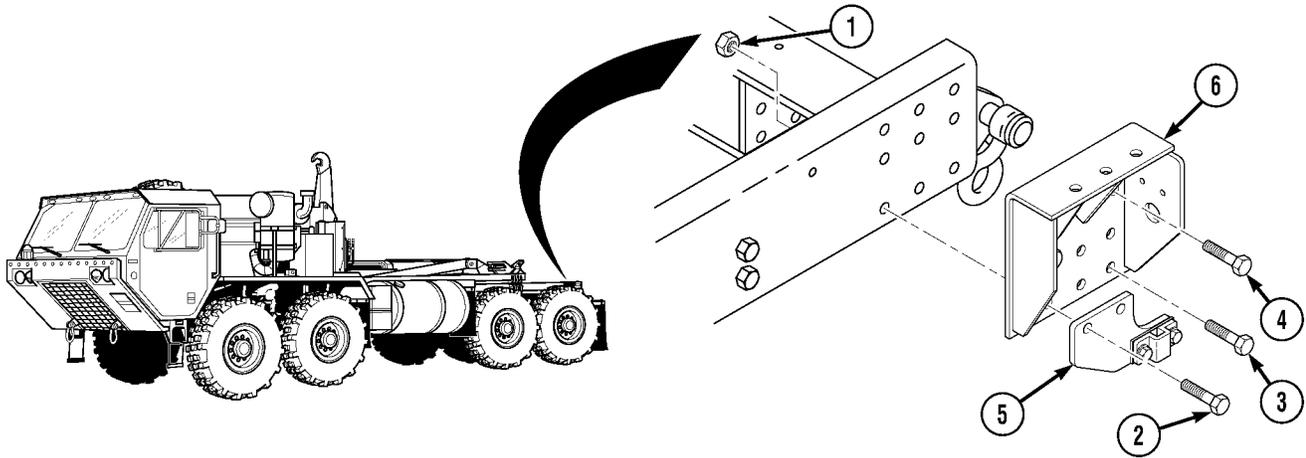

a. Rear Mounting Bracket Removal.

NOTE

Both rear mounting brackets are removed the same way. Left side is shown.

- (1) Remove nine locknuts (1), screw (2), five screws (3), three screws (4), mud flap bracket (5), and rear mounting bracket (6). Discard locknuts.

b. Rear Mounting Bracket Installation.

- (1) Install rear mounting bracket (6) and mud flap bracket (5) with three screws (4), five screws (3), screw (2), and nine locknuts (1).
- (2) Tighten locknuts (1).

c. Follow-on Maintenance.

- (1) Install rear roller assembly (Para 4-48).
- (2) Install rear marker light assembly (Para 4-43).
- (3) Install rear composite lights (TM 9-2320-279-20).
- (4) Remove wheel chocks (TM 9-2320-279-10).
- (5) Install rear mud flaps (TM 9-2320-279-20).

END OF TASK

Direct Support and General Support Maintenance (Cont)

5-28. LOAD HANDLING SYSTEM (LHS) MAIN FRAME NOSE SUPPORT REPLACEMENT.	
This task covers:	
a. Removal	b. Installation
c. Follow-on Maintenance	
INITIAL SETUP	
<i>Models</i> M1120	<i>References</i> None
<i>Test Equipment</i> None	<i>Equipment Condition</i> <i>TM or Para</i> <i>Condition Description</i> TM 9-2320-279-10 Engine OFF TM 9-2320-279-10 Wheels chocked Para 2-9 Main frame up
<i>Special Tools</i> Tool Kit, General Mechanic's, Item 32, Appendix B	<i>Special Environmental Conditions</i> None
<i>Supplies</i> Locknut (8) Item 1, Appendix K	<i>General Safety Instructions</i> None
<i>Personnel Required</i> MOS 63W, Wheel vehicle repairer	

a. Removal.

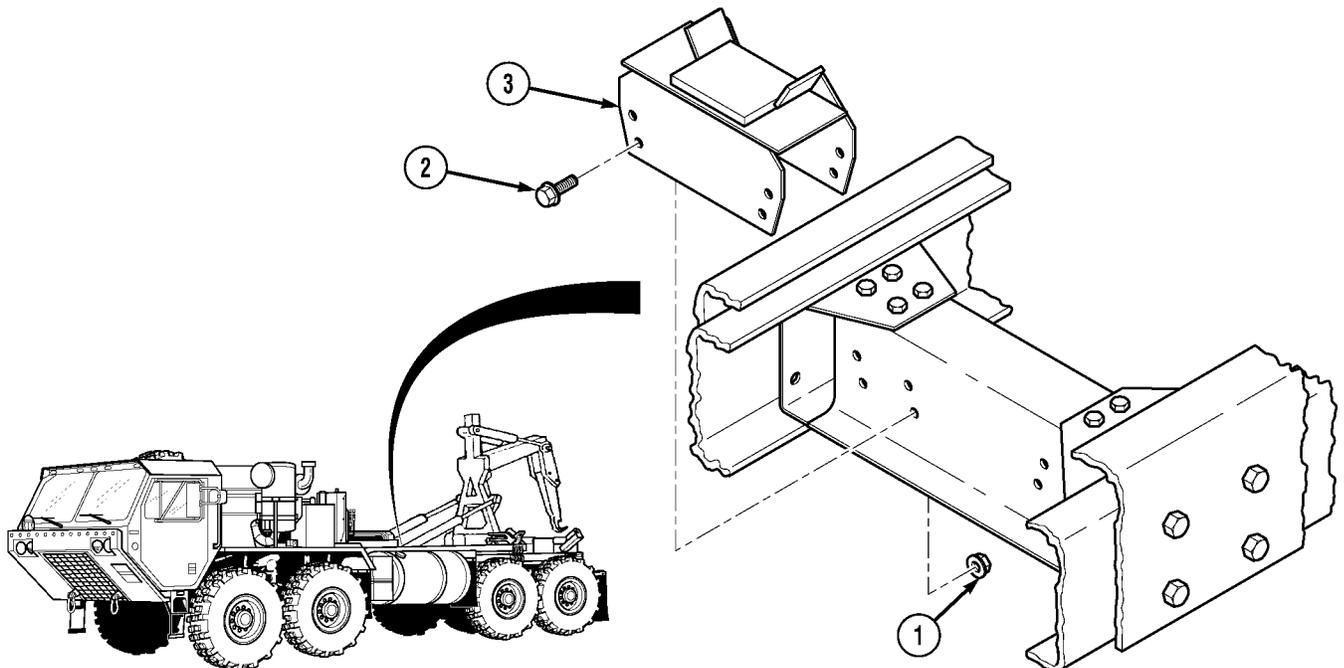

(1) Remove eight locknuts (1), capscrews (2), and main frame nose support (3). Discard locknuts.

Direct Support and General Support Maintenance (Cont)

5-28. LOAD HANDLING SYSTEM (LHS) MAIN FRAME NOSE SUPPORT REPLACEMENT (CONT).

b. Installation.

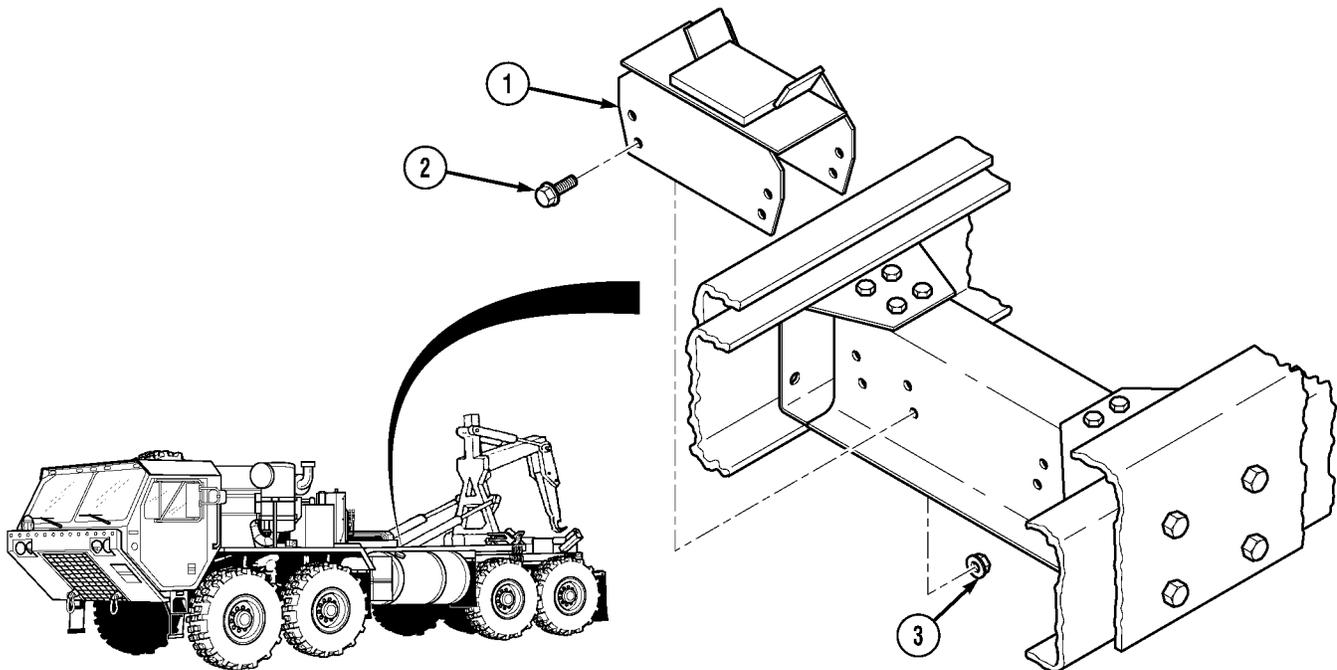

(1) Install main frame nose support (1), eight cap screws (2), and locknuts (3). Tighten locknuts.

c. Follow-on Maintenance.

- (1) Stow LHS (Para 2-9).
- (2) Remove wheel chocks (TM 9-2320-279-10).

END OF TASK

Organizational Maintenance Instructions (Cont)

5-28.1 CONTAINER HANDLING UNIT (CHU) SLIDER ARM ASSEMBLY REPAIR.

This task covers:

- | | | |
|----------------|------------------------|--------------------------|
| a. Removal | c. Cleaning/Inspection | e. Installation |
| b. Disassembly | d. Assembly | f. Follow-on Maintenance |

INITIAL SETUP

Models

M1120

Test Equipment

None

Special Tools

Tool Kit, General Mechanic's: Automotive, Item 33, Appendix B
 Compressor Unit, Air, Item 2.2, Appendix B
 Gloves, Chemical Oil Protective, Item 11, Appendix B
 Goggles, Industrial, Item 12, Appendix B
 Gun, Air Blow, Item 12.1, Appendix B
 Pliers, Retaining Ring, Item 19, Appendix B
 Lifting Device, Minimum Capacity 240 lbs. (109 kg)

Supplies

Adhesive, Item 1, Appendix F
 Grease, Item 8, Appendix F
 Sealing Compound, Item 15.1, Appendix F
 Sealing Compound, Item 16, Appendix F
 Preformed Packing, Item 30.1, Appendix K

Supplies (cont)

Preformed Packing, Item 30.2, Appendix K
 Seal, Item 42.1, Appendix K
 Seal, Item 43.1, Appendix K

Personnel Required

MOS 63S, Heavy wheel vehicle mechanic (2)

References

None

Equipment Condition

<i>TM or Para</i>	<i>Condition Description</i>
TM 9-2320-279-10	Engine OFF
TM 9-2320-279-10	Wheels chocked
Para 4-53.2	Slider/pivot removed
Para 4-53.4	Pin bracket assembly removed
Para 4-48	Horizontal roller removed

Special Environmental Conditions

None

General Safety Instructions

None

Organizational Maintenance Instructions (Cont)

5-28.1 CONTAINER HANDLING UNIT (CHU) SLIDER ARM ASSEMBLY REPAIR (CONT).

a. Removal.

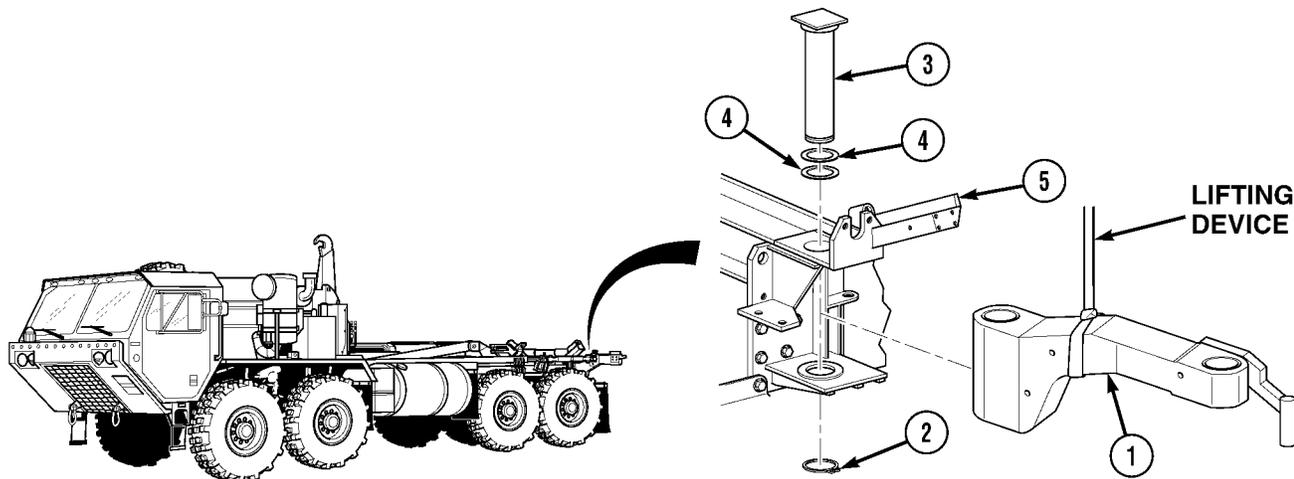

WARNING

Arm assembly weighs 240 lbs. (109 kg). Attach suitable lifting device to prevent possible injury to personnel.

NOTE

There are two arm assemblies. Both are removed the same way. Right side is shown.

- (1) Attach lifting device to arm assembly (1).

NOTE

Note quantity of shims prior to removal.

- (2) Remove retaining ring (2), pivot pin (3), and shim(s) (4) from rear roller bracket (5) and arm assembly (1).
- (3) Soldier A and Soldier B remove arm assembly (1) from rear roller bracket (5).
- (4) Position arm assembly (1) on clean work surface and remove lifting device.

b. Disassembly.

- (1) Remove seal (1), thrust washer (2), and preformed packing (3) from large end of arm assembly (4). Discard seal and preformed packing.

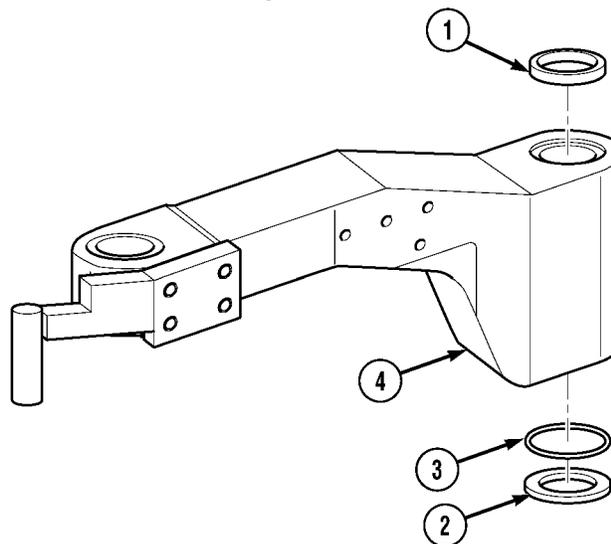

Organizational Maintenance Instructions (Cont)

- (2) Remove seal (5), preformed packing (6), and thrust washer (7) from small end of arm assembly (4). Discard seal and preformed packing.

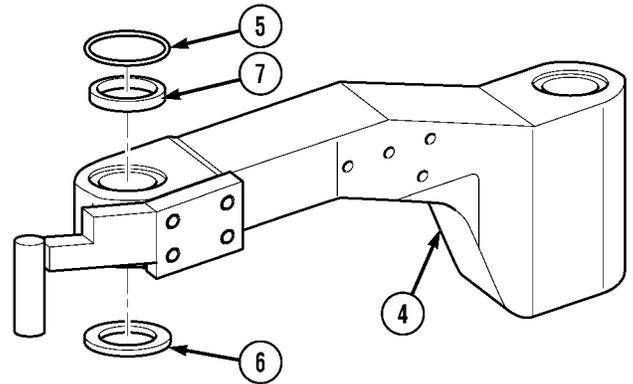

NOTE

Note quantity of shim(s) for assembly.

- (3) Remove four screws (8) and handle (9) from arm assembly (4).
 (4) Remove grease fitting (10) and grease fitting (11) from arm assembly (4).

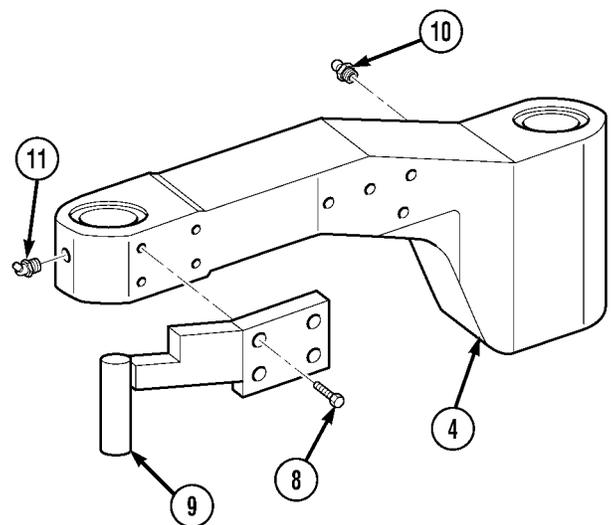

c. Cleaning/Inspection.

WARNING

- Drycleaning Solvent (P-D-680) is TOXIC and flammable. Wear protective goggles, face shield, and gloves; use only in a well-ventilated area; avoid contact with skin, eyes, and clothes; and do not breathe vapors. Keep away from heat or flame. Never smoke when using solvent. The flashpoint for Type III Drycleaning Solvent is 200°F (93°C). Failure to do so may result in injury or death to personnel.
- If personnel become dizzy while using cleaning solvent, immediately get fresh air and medical help. If solvent contacts skin or clothes, flush with cold water. If solvent contacts eyes, immediately flush eyes with water and get immediate medical attention.

- (1) Clean all metal parts with drycleaning solvent.

Organizational Maintenance Instructions (Cont)

5-28.1 CONTAINER HANDLING UNIT (CHU) SLIDER ARM ASSEMBLY REPAIR (CONT).**WARNING**

Compressed air used for cleaning purposes shall not exceed 30 psi (207 kPa). Use only with effective chip guarding and personal protective equipment (goggles/shield, gloves, etc.), or injury to personnel may result.

- (2) Dry parts with compressed air.
- (3) Inspect parts for breaks, cracks, burrs, and sharp edges. Look for unusual signs of wear on arm.
- (4) Insert thrust washers. Make sure yellow coating is visible over entire wear surface (or thrust washers are not less than 0.0795 in. [0.202 cm] thick). If yellow coating is worn, replace with new thrust washers.
- (5) Replace all damaged parts.

d. Assembly.

- (1) Install grease fitting (1) and grease fitting (2) in arm assembly (3).

WARNING

Adhesives, solvents, and sealing compounds can burn easily, can give off harmful vapors, and are harmful to skin and clothing. To avoid injury or death, keep away from open fire and use in well-ventilated area. If adhesive, solvent, or sealing compound gets on skin or clothing, wash immediately with soap and water.

- (2) Apply sealing compound to threads of four screws (4).

NOTE

Install quantity of shim(s) as noted during disassembly.

- (3) Install handle (5) and four screws (4) on arm assembly (3).

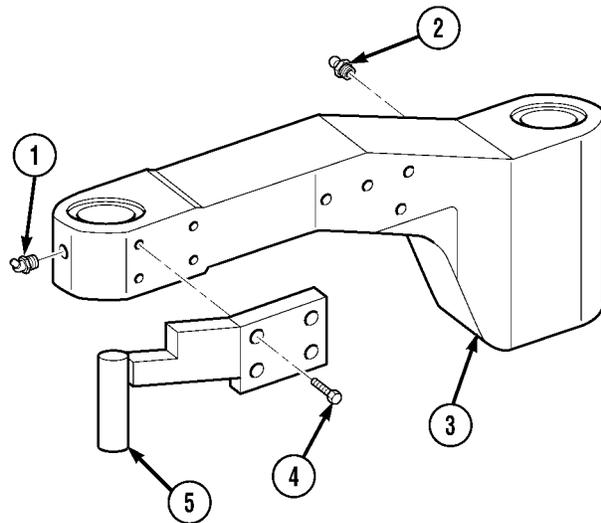

Organizational Maintenance Instructions (Cont)

WARNING

Adhesives, solvents, and sealing compounds can burn easily, can give off harmful vapors, and are harmful to skin and clothing. To avoid injury or death, keep away from open fire and use in well-ventilated area. If adhesive, solvent, or sealing compound gets on skin or clothing, wash immediately with soap and water.

NOTE

Sealing compound is applied to metallic side of thrust washer (6).

- (4) Apply sealing compound (Loctite 680) to thrust washer (6).
- (5) Apply adhesive (Loctite 409) to six points in recessed groove for preformed packing (7).

NOTE

Thrust washer is properly installed with metallic side to arm assembly.

- (6) Install thrust washer (6), preformed packing (7), and seal (8) in arm assembly (3).

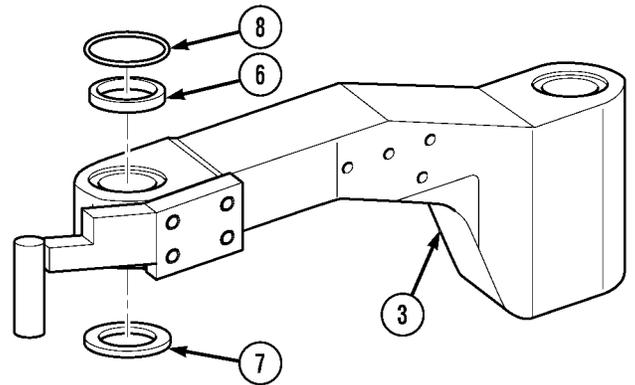

WARNING

Adhesives, solvents, and sealing compounds can burn easily, can give off harmful vapors, and are harmful to skin and clothing. To avoid injury or death, keep away from open fire and use in well-ventilated area. If adhesive, solvent, or sealing compound gets on skin or clothing, wash immediately with soap and water.

NOTE

Sealing compound is applied to metallic side of thrust washer (9).

- (7) Apply sealing compound (Loctite 680) to thrust washer (9).
- (8) Apply adhesive (Loctite 409) to six points in recessed groove for preformed packing (10).

NOTE

Thrust washer is properly installed with metallic side to arm assembly.

- (9) Install preformed packing (10), thrust washer (9), and seal (11) on arm assembly (3).

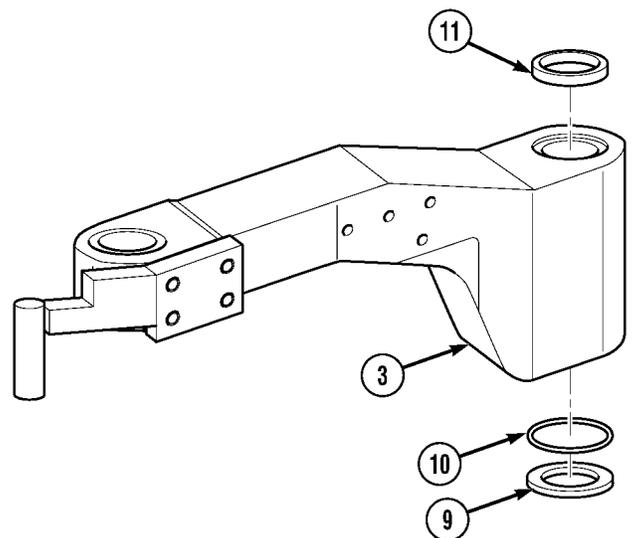

Organizational Maintenance Instructions (Cont)

5-28.1 CONTAINER HANDLING UNIT (CHU) SLIDER ARM ASSEMBLY REPAIR (CONT).

e. Installation.

- (1) Apply grease to face of thrust washer, seal, bore in arm assembly (1), and bores and thrust face of rear roller bracket (2).

WARNING

Arm assembly weighs 240 lbs. (109 kg). Attach suitable lifting device to prevent possible injury to personnel.

- (2) Attach lifting device to arm assembly (1).

CAUTION

Make sure not to damage bottom of preformed packing during arm installation.

- (3) Soldier A and Soldier B position large end of arm assembly (1) in rear roller bracket (2).

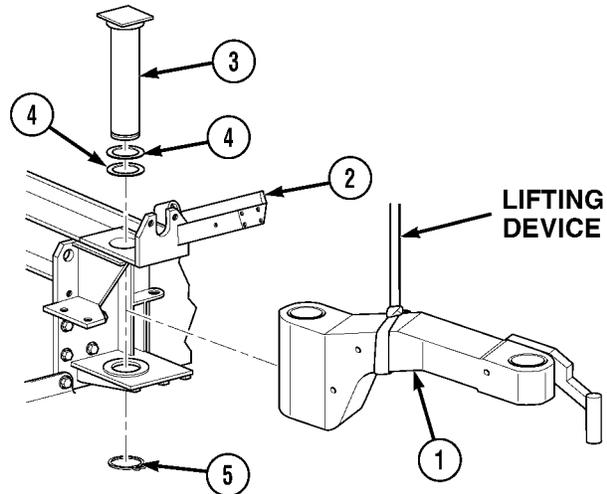

WARNING

Use care when installing snap and retaining rings. Snap and retaining rings are under spring tension and can act as projectiles when released and could cause severe eye injury.

NOTE

Install amount of shim(s) as noted prior to removal.

- (4) Apply grease to outer surface of pivot pin (3) and install pivot pin, shim(s) (4), and retaining ring (5) in arm assembly (1) and rear roller bracket (2).
- (5) Remove lifting device from arm assembly (1).

f. Follow-on Maintenance.

- (1) Install horizontal roller (Para 4-48).
- (2) Install pin bracket assembly (Para 4-53.4).
- (3) Install slider/pivot assembly (Para 4-53.2).
- (4) Lubricate slider arm (Para 3-2).
- (5) Remove wheel chocks (TM 9-2320-279-10).

END OF TASK

5-29. OVERVIEW (HYDRAULIC SYSTEM).

The hydraulic pump is driven by the power takeoff (PTO) mounted on the transmission. There is a PTO switch mounted in the cab to engage and disengage the PTO. The vehicle must be in neutral for proper operation of the LHS.

Direct Support and General Support Maintenance (Cont)

5-30. LOAD HANDLING SYSTEM (LHS) MAIN HYDRAULIC PRESSURE ADJUSTMENT.	
This task covers:	
a. Adjustment	b. Follow-on Maintenance
INITIAL SETUP	
<i>Models</i> M1120	<i>References</i> None
<i>Test Equipment</i> None	<i>Equipment Condition</i> <i>TM or Para</i> <i>Condition Description</i> TM 9-2320-279-10 Wheels chocked TM 9-2320-279-10 Engine OFF
<i>Special Tools</i> Tool Kit, General Mechanic's, Item 32, Appendix B Kit, Pressure Test, Item 13, Appendix B	<i>Special Environmental Conditions</i> None
<i>Supplies</i> Lockwasher (4), Item 18, Appendix K	<i>General Safety Instructions</i> None
<i>Personnel Required</i> MOS 63W, Wheel vehicle repairer	

a. Adjustment.

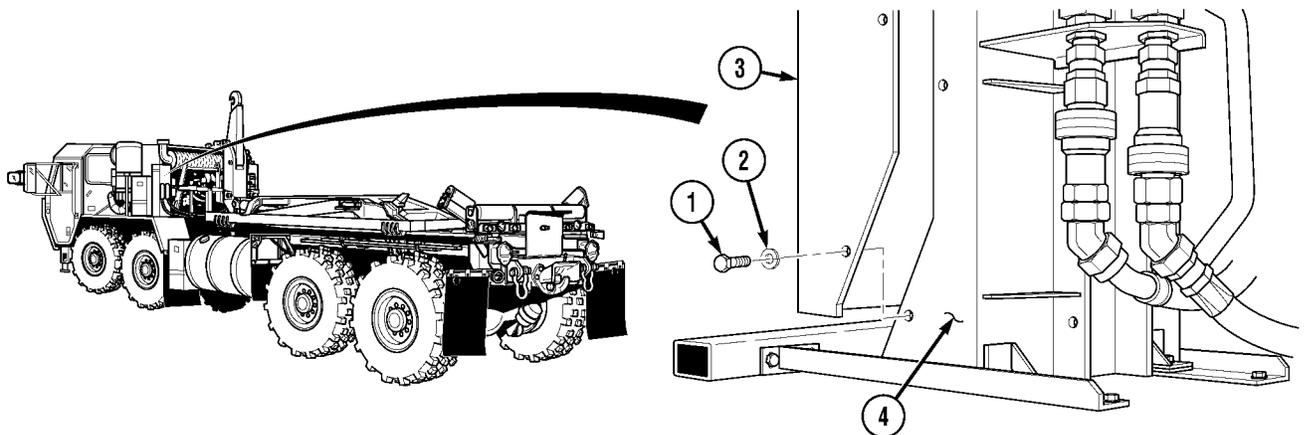

NOTE

Only remove center screw on engine side of LHS control box cover.

- (1) Remove four screws (1), lockwashers (2), and LHS control box cover (3) from bracket (4). Discard lockwasher.

Direct Support and General Support Maintenance (Cont)

5-30. LOAD HANDLING SYSTEM (LHS) MAIN HYDRAULIC PRESSURE ADJUSTMENT (CONT).

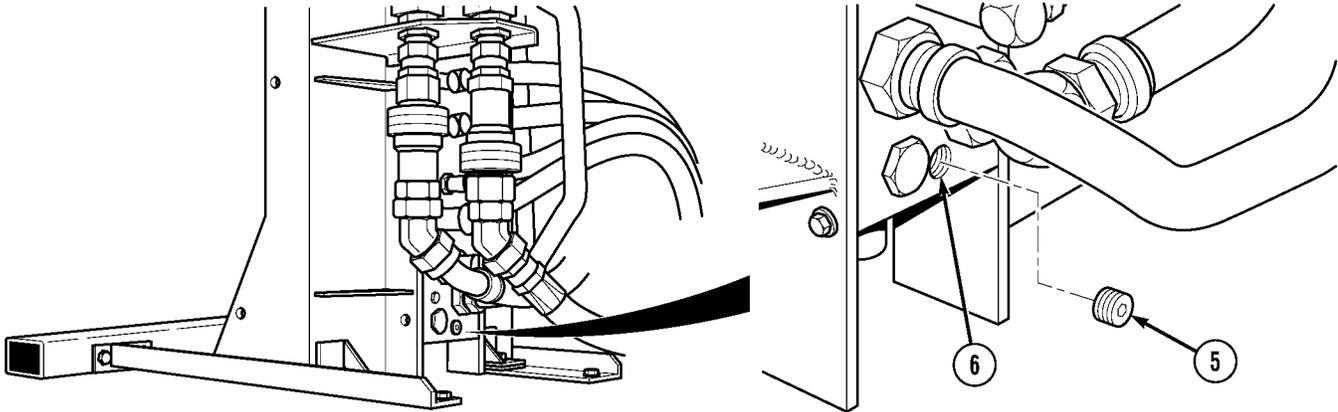

(2) Remove pipe plug (5) from port TPP (6).

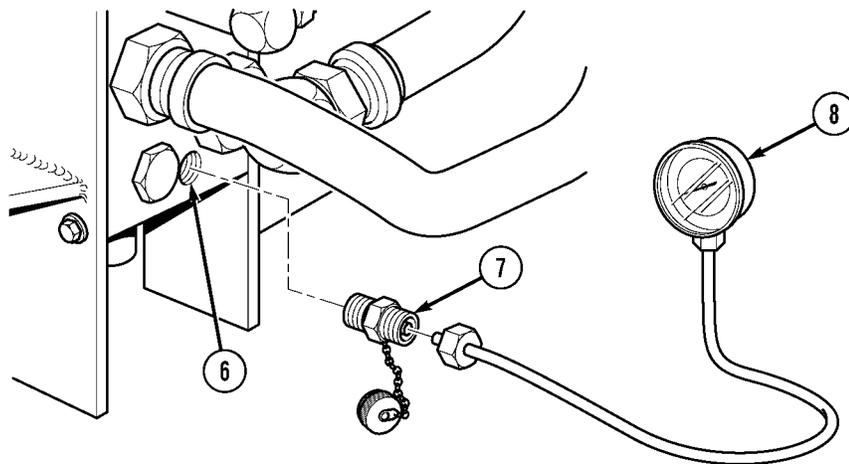

(3) Install pressure test fitting (7) on 0-2500 psi (0-17 237 kPa) pressure gage (8) in hydraulic manifold port TPP (6).

Direct Support and General Support Maintenance (Cont)

NOTE

- Hydraulic oil in reservoir must be 120°F (49°C) ±5° to obtain proper pressure reading for HEMTT LHS.
- Hydraulic oil in reservoir must be 105°F (41°C) ±5° to obtain proper pressure reading for HEMTT LHS with CHU.
- Engine must be at full throttle to obtain proper pressure reading on HEMTT LHS with CHU.

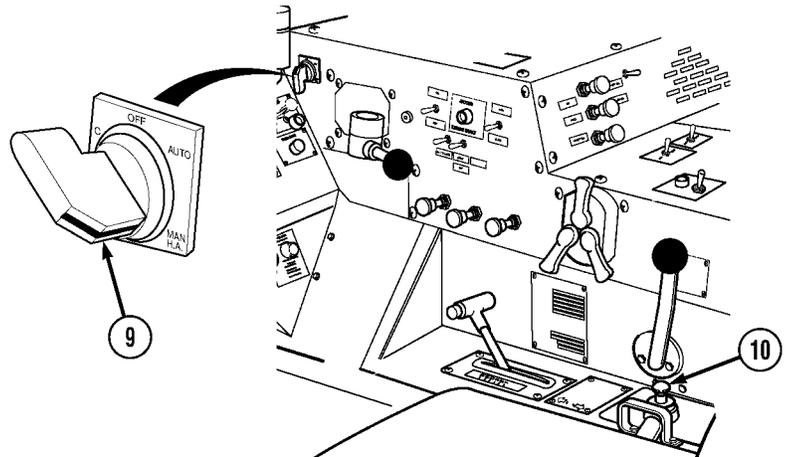

- (4) Soldier A, start engine (TM 9-2320-279-10), engage PTO (TM 9-2320-279-10), put hydraulic selector switch (9) in MAN H.A. (Para 2-9) and move joystick (10) to LOAD. Soldier B, record pressure reading.
- (5) Shut off engine (TM 9-2320-279-10).

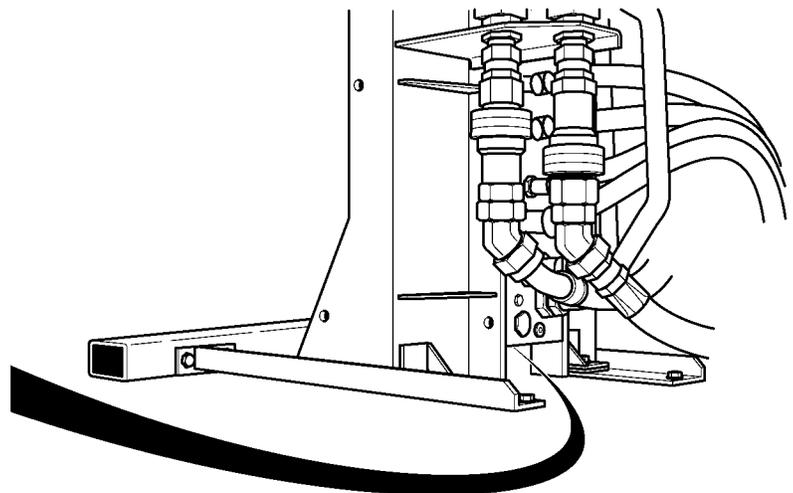
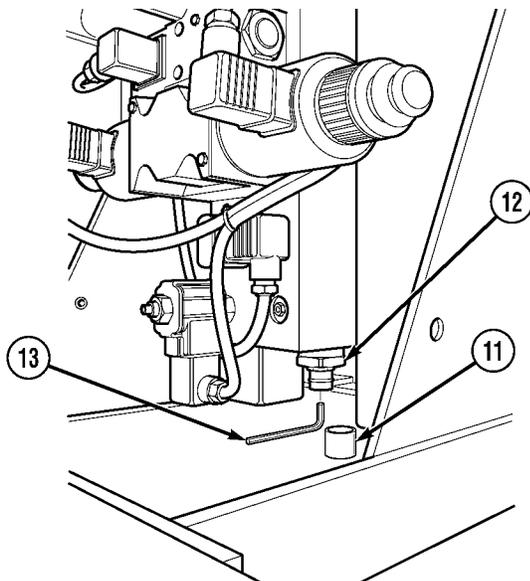

- (6) Remove cap (11).
- (7) Loosen jam nut (12).

NOTE

- Turn in to raise pressure, turn out to reduce pressure.
 - Use step (8) to adjust hydraulic pressure on HEMTT LHS. Use step (8.1) to adjust hydraulic pressure on HEMTT LHS with CHU.
- (8) Install 3/16 in. hex head wrench (13) and adjust pressure to 1,725 psi to 1,750 psi (11 894 kPa to 12 066 kPa).
 - (8.1) Install 3/16 in. hex head wrench (13) and adjust pressure to 2,350 psi ±25 psi (16 203 kPa ±172 kPa).
 - (9) Tighten jam nut (12).

Direct Support and General Support Maintenance (Cont)

5-30. LOAD HANDLING SYSTEM (LHS) MAIN HYDRAULIC PRESSURE ADJUSTMENT (CONT).

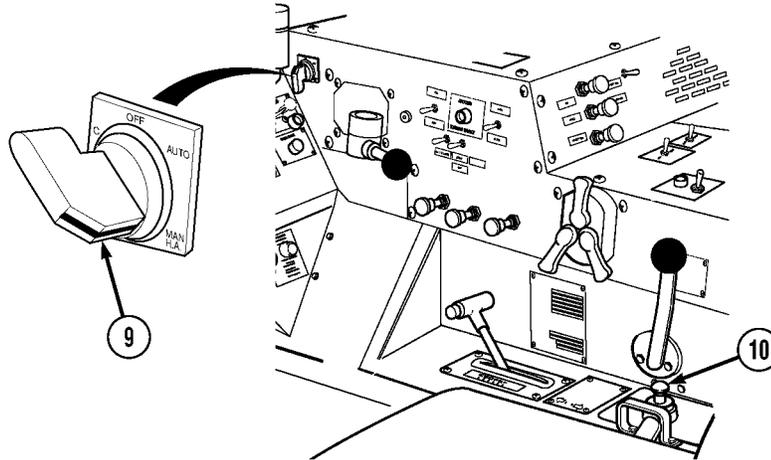

NOTE

- Hydraulic oil in reservoir must be 120°F (49°C) ±5° to obtain proper pressure reading for HEMTT LHS.
- Hydraulic oil in reservoir must be 105°F (41°C) ±5°.
- Engine must be at full throttle to obtain proper pressure reading on HEMTT LHS with CHU.

- (10) Soldier A, start engine (TM 9-2320-279-10), engage PTO (TM 9-2320-279-10), put hydraulic selector switch (9) in MAN H.A. (Para 2-9) and move joystick (10) to LOAD position. Soldier B, record pressure.
- (11) Shut off engine (TM 9-2320-279-10).
- (12) Repeat steps (7) thru (11) until pressure setting is correct.

Direct Support and General Support Maintenance (Cont)

5-30. LOAD HANDLING SYSTEM (LHS) MAIN HYDRAULIC PRESSURE ADJUSTMENT (CONT).

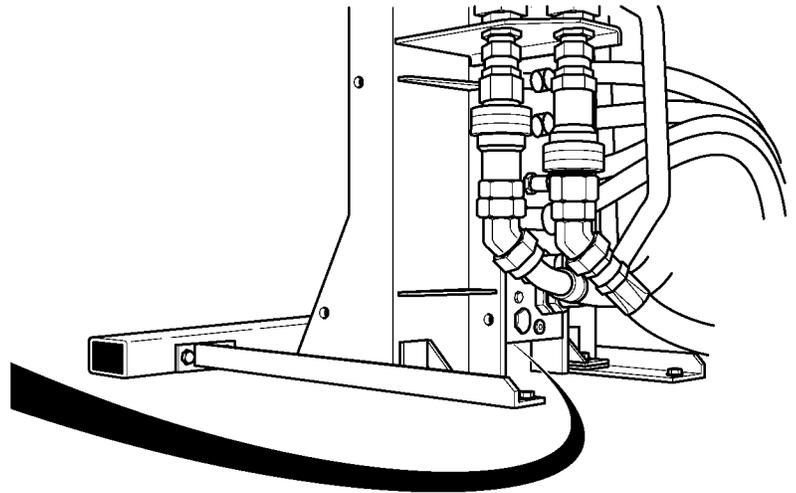
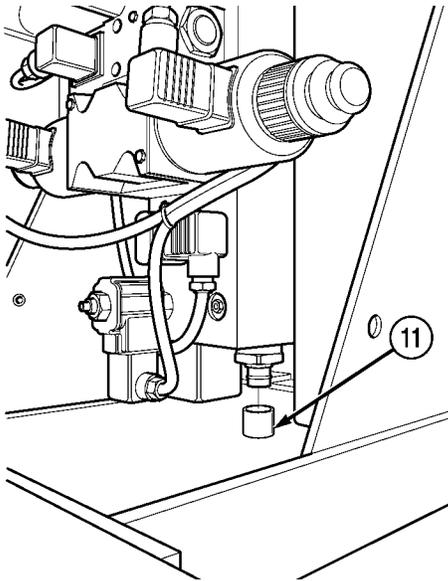

- (13) Install cap (11).
- (14) Disengage PTO (TM 9-2320-279-10) and put hydraulic selector switch (9) in OFF position (Para 2-9).

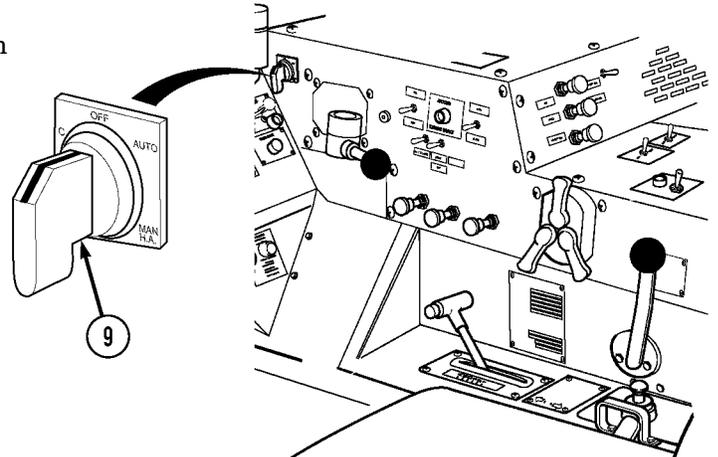

Direct Support and General Support Maintenance (Cont)

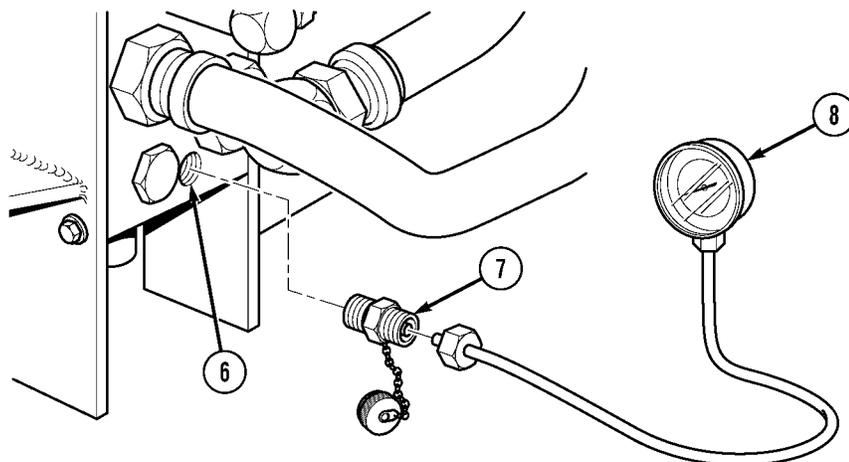

(15) Remove pressure gage (8) and pressure test fitting (7) from port TPP (6).

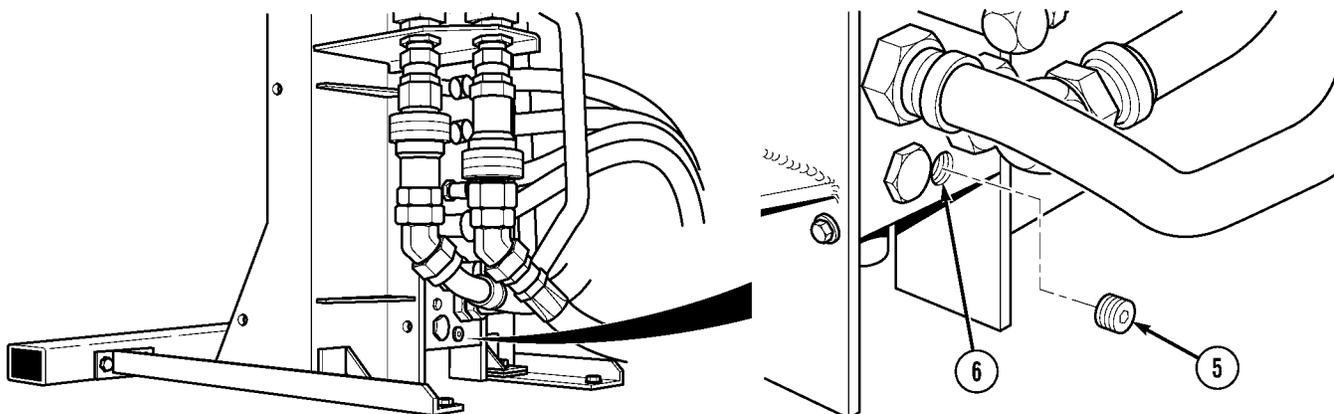

(16) Install pipe plug (5) into port TPP (6).

(17) Install LHS control box cover (3) on bracket (4) with four screws (1) and lockwashers (2).

b. Follow-on Maintenance. Remove wheel chocks (TM 9-2320-279-10).

END OF TASK

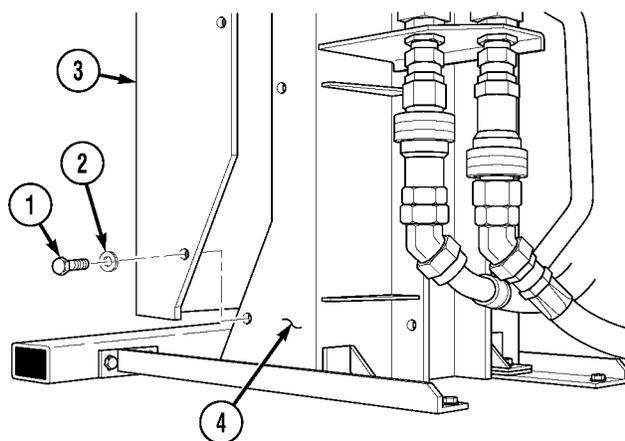

Direct Support and General Support Maintenance (Cont)

5-31. LOAD HANDLING SYSTEM (LHS) MAIN MANIFOLD/BRACKET REPLACEMENT.

This task covers:

- a. Removal
- b. Installation
- c. Follow-on Maintenance

INITIAL SETUP

Models

M1120

Test Equipment

None

Special Tools

Tool Kit, General Mechanic's, Item 32, Appendix B

Cap and Plug Set, Item 2, Appendix B

Pan, Drain 4 gal, Item 16, Appendix B

Torch, Propane, Item 34, Appendix B

Wrench Set, Socket 3/8 in. Drive, Item 44, Appendix B

Wrench, Torque (0-60 N•m), Item 47, Appendix B

Lifting Device, Minimum Capacity 150 lbs. (68 kg)

Supplies

Oil, Hydraulic, Item 12, Appendix F

Sealing Compound, Item 15, Appendix F

Tags, Identification, Item 19, Appendix F

Locknut (4), Item 4, Appendix K

Locknut, Item 6, Appendix K

Locknut (6), Item 11, Appendix K

Lockwasher (8), Item 12, Appendix K

Lockwasher (8), Item 20, Appendix K

Packing, Preformed (4), Item 28, Appendix K

Packing, Preformed (2), Item 29, Appendix K

Supplies - (Cont.)

Packing, Preformed (6), Item 30, Appendix K

Parts Kit, Seal, Item 31, Appendix K

Preformed Packing Kit, Item 36, Appendix K

Personnel Required

MOS 63W, Wheel vehicle repairer

References

None

Equipment Condition

<i>TM or Para</i>	<i>Condition Description</i>
TM 9-2320-279-10	Engine OFF
TM 9-2320-279-10	Wheels chocked
TM 9-2320-279-20	Batteries disconnected
Para 5-42	LHS main manifold load control valve removed.
Para 5-38	LHS check valve removed
Para 5-34	LHS main manifold relief valve removed
Para 5-35	LHS solenoid valve and coil removed.
Para 5-36	LHS directional control valve removed.
Para 5-33	LHS transit valve removed.

Special Environmental Conditions

None

General Safety Instructions

None

Direct Support and General Support Maintenance (Cont)

5-31. LOAD HANDLING SYSTEM (LHS) MAIN MANIFOLD/BRACKET REPLACEMENT (CONT).

a. Removal.

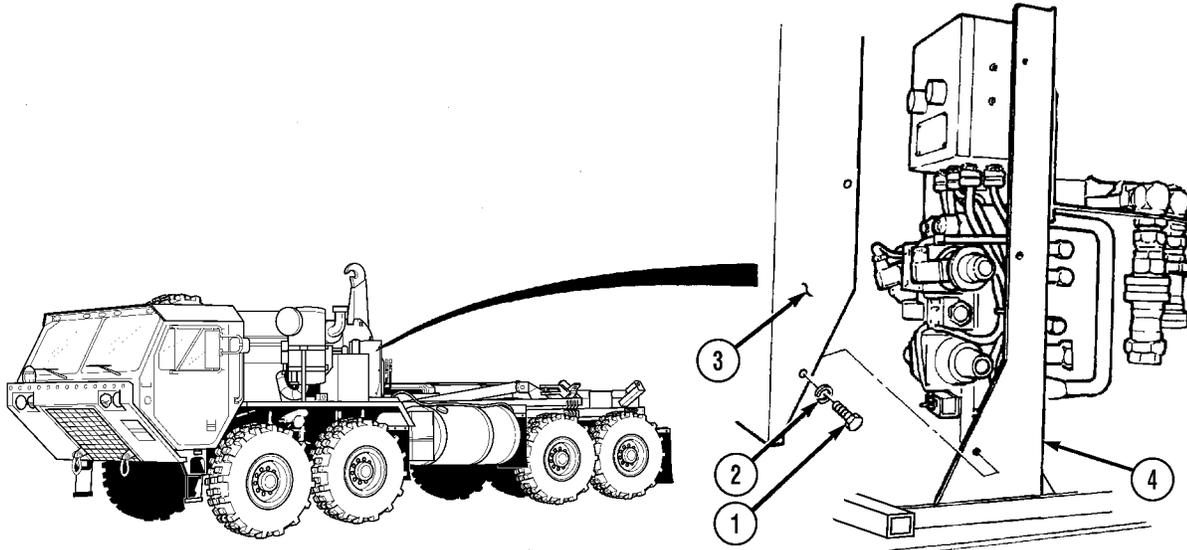

NOTE

Only remove center screw on engine side of LHS main junction box cover.

- (1) Remove four screws (1), lockwashers (2), and cover (3) from bracket (4). Discard lockwashers.

NOTE

Tag and mark wires prior to removal.

- (2) Disconnect MC82 connector (5) and MC85 connector (6) from LHS main junction box (7).
- (3) Position drain pan under bracket (4).

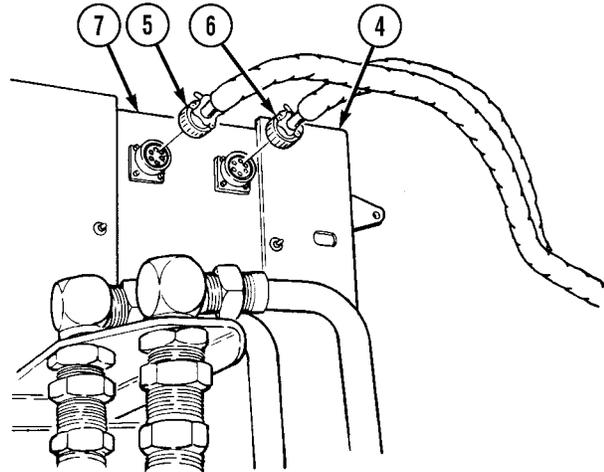

Direct Support and General Support Maintenance (Cont)

WARNING

The LHS hydraulic system operates at oil pressures up to 1,725 psi (11 894 kPa). Never disconnect any hydraulic line or fitting without first dropping pressure to zero. Failure to comply may result in serious injury or death to personnel.

NOTE

Cap and plug all hoses, tubes, and fittings after removal.

- (4) Remove couplings (8 and 9) from fittings (10 and 11).
- (5) Remove hose 2887 (12) and hose 2588 (13) from elbows (14 and 15).
- (6) Remove hose 2888 (16) and hose 2666 (17) from elbows (18 and 19).

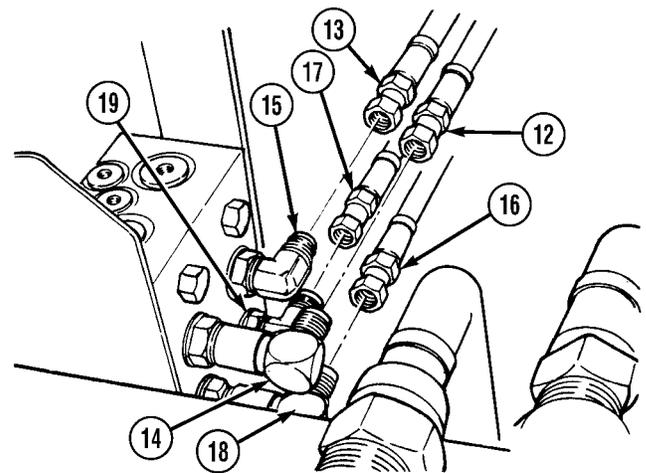
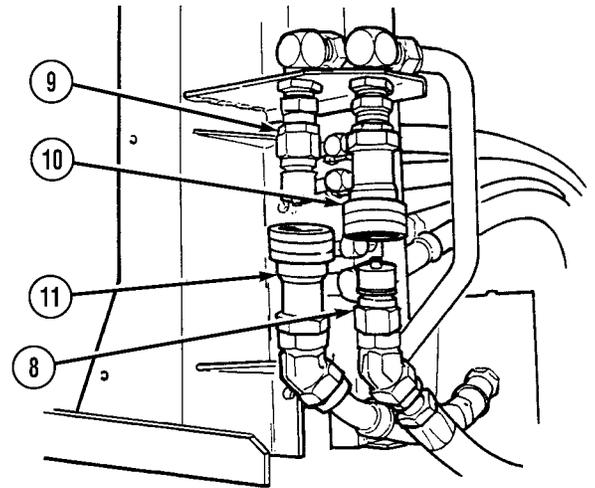

- (7) Remove hose 2890 (20) and hose 2889 (21) from elbows (22 and 23).
- (8) Remove hose 2892 (24) and hose 2891 (25) from elbows (26 and 27).

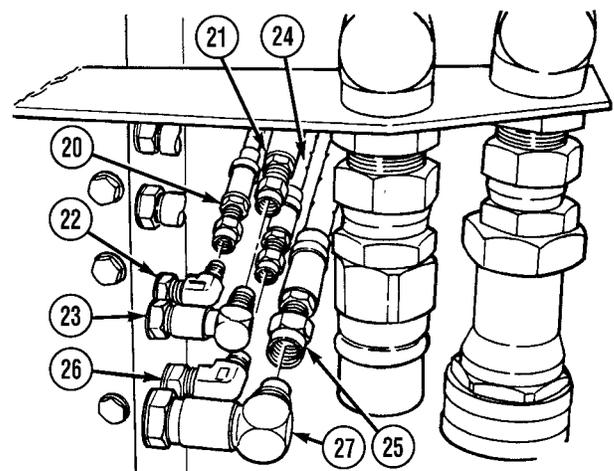

Direct Support and General Support Maintenance (Cont)

5-31. LOAD HANDLING SYSTEM (LHS) MAIN MANIFOLD/BRACKET REPLACEMENT (CONT).

- (9) Remove four locknuts (28) and two screws (29 and 30) from bracket assembly (4). Discard locknuts.

WARNING

Bracket weighs 120 lbs. (54 kg). Attach suitable lifting device prior to removal to prevent possible injury to personnel.

- (10) Attach lifting device to bracket (4).
- (11) Remove bracket (4) from fender (31).
- (12) Position bracket (4) on clean work surface.
- (13) Remove lifting device from bracket (4).

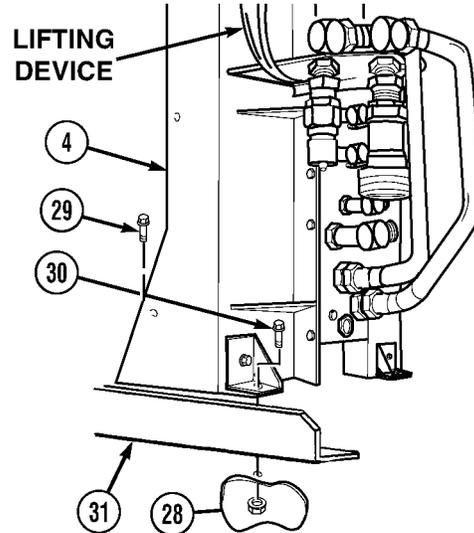

- (14) Remove two locknuts (32), screws (33), and brackets (34 and 35). Discard locknuts.
- (15) Remove oil tube (36) from fitting (37) and elbow (38).
- (16) Remove oil tube (39) from fitting (40) and elbow (41).

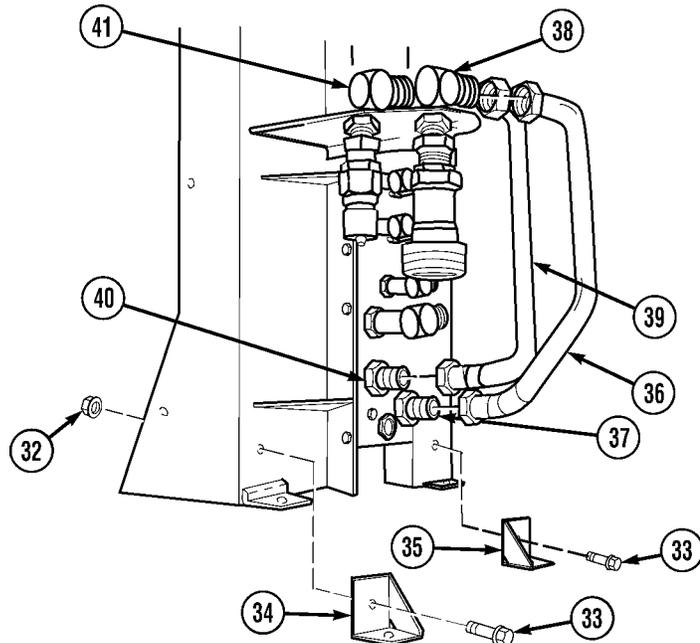

Direct Support and General Support Maintenance (Cont)

- (17) Remove couplings (42 and 43) and two preformed packings (44) from fittings (45). Discard preformed packings.
- (18) Remove two nuts (46), elbow (38), and elbow (41) from bracket (47).

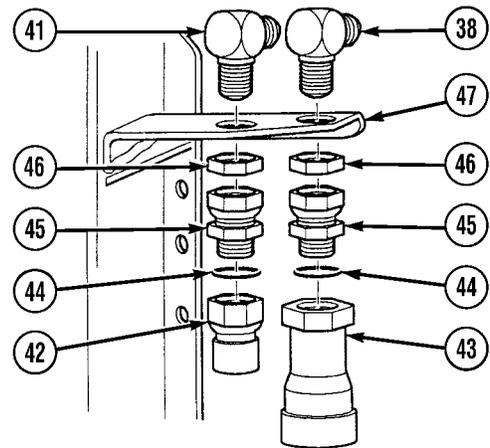

- (19) Loosen four screws (48) and remove cover (49) from LHS junction box (7).
- (20) Remove four locknuts (50), screws (51), and LHS junction box (7) from LHS manifold assembly (4). Discard locknuts.
- (21) Remove eight screws (52), lockwashers (53), and bracket (4) from hydraulic manifold (54). Discard lockwashers.
- (22) Heat screw (55) where installed to LHS manifold bracket assembly (4) with propane torch.

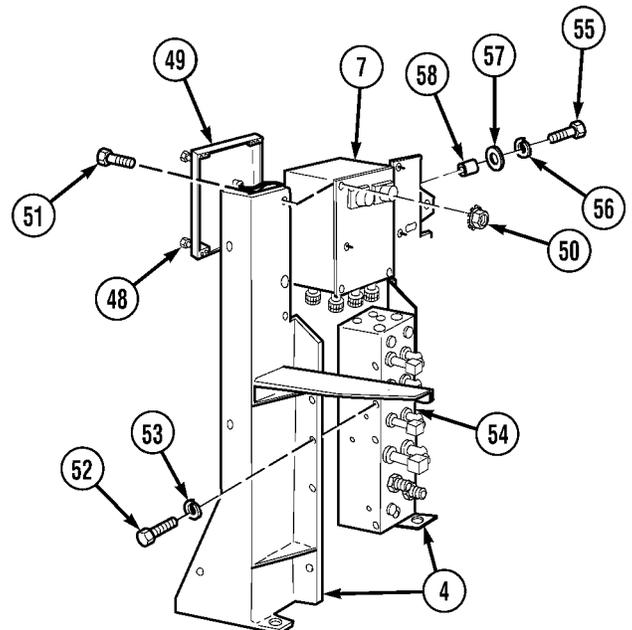

WARNING

Screws are extremely hot. Do not touch screws without protective gloves or severe burns to hands could result.

- (23) Remove two screws (55), lockwashers (56), washers (57), and spacers (58) from bracket (4). Discard lockwashers.

Direct Support and General Support Maintenance (Cont)

5-31. LOAD HANDLING SYSTEM (LHS) MAIN MANIFOLD/BACKET REPLACEMENT (CONT).

- (24) Remove switch (59) and preformed packings (60 and 61) from hydraulic manifold (54). Discard preformed packings.
- (25) Remove plug (62) and preformed packing (63) from hydraulic manifold (54). Discard preformed packing.
- (26) Remove two plugs (64) and preformed packings (65) from hydraulic manifold (54). Discard preformed packings.
- (27) Remove plug (66) and preformed packing (67) from hydraulic manifold (54). Discard preformed packing.

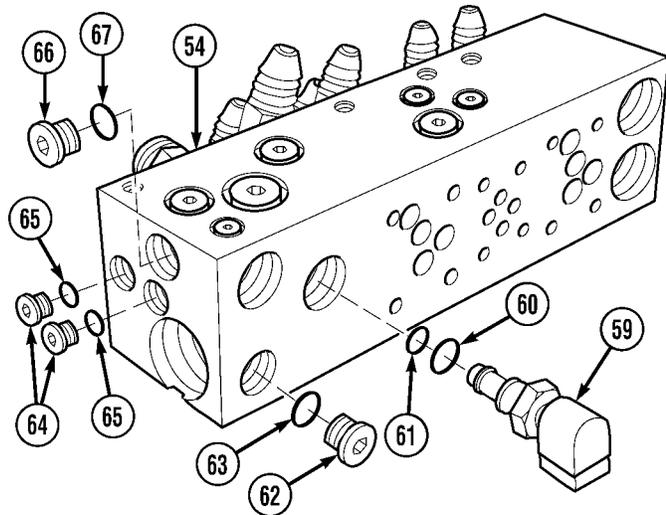

- (28) Remove plug (68) and preformed packing (69) from hydraulic manifold (54). Discard preformed packing.
- (29) Remove plug (70), check valve (71), and preformed packings (72, 73, and 74) from hydraulic manifold (54). Discard preformed packings.
- (30) Remove plug (64) and preformed packing (65) from hydraulic manifold (54). Discard preformed packing.
- (31) Remove plug (62) and preformed packing (63) from hydraulic manifold (54).

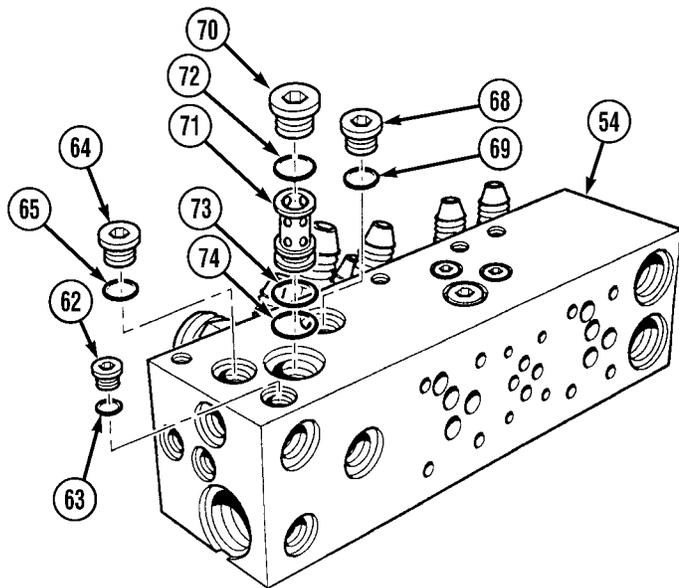

Direct Support and General Support Maintenance (Cont)

- (32) Remove plug (75) and preformed packing (76) from hydraulic manifold (54). Discard preformed packing.
- (33) Remove two plugs (62) and preformed packings (63) from hydraulic manifold (54). Discard preformed packings.
- (34) Remove orifice plug (77) from hydraulic manifold (54).

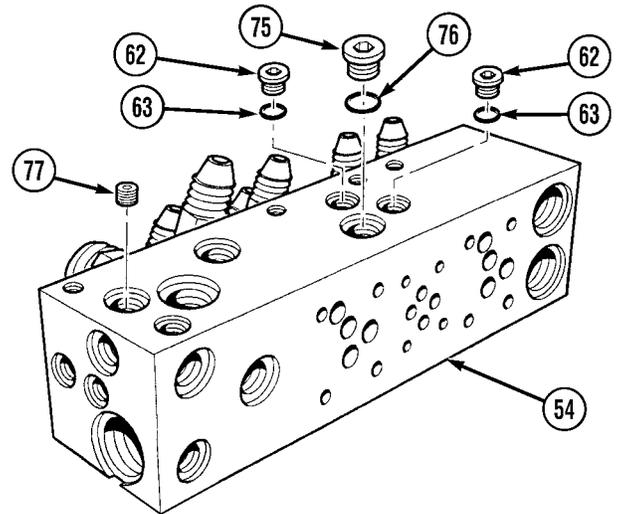

- (35) Loosen three nuts (78) and remove elbows (14, 18, and 23) and preformed packings (79) from hydraulic manifold (54). Discard preformed packings
- (36) Loosen three nuts (80) and remove elbows (15, 19, and 22) and preformed packings (79) from hydraulic manifold (54). Discard preformed packings.

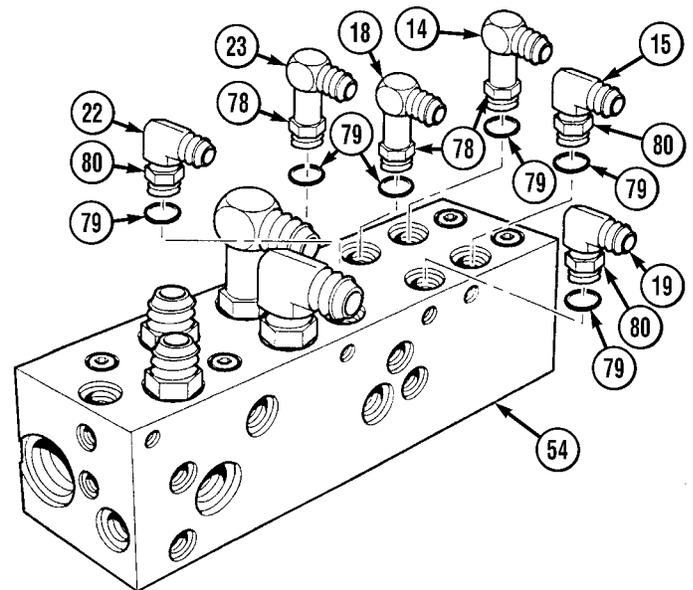

Direct Support and General Support Maintenance (Cont)

5-31. LOAD HANDLING SYSTEM (LHS) MAIN MANIFOLD/BRACKET REPLACEMENT (CONT).

- (37) Loosen nut (81) and remove elbow (27) and preformed packing (82) from hydraulic manifold (54). Discard preformed packing.
- (38) Loosen nut (83) and remove elbow (26) and preformed packing (82) from hydraulic manifold (54). Discard preformed packing.
- (39) Remove two fittings (84) and preformed packings (82) from hydraulic manifold (54). Discard preformed packings.

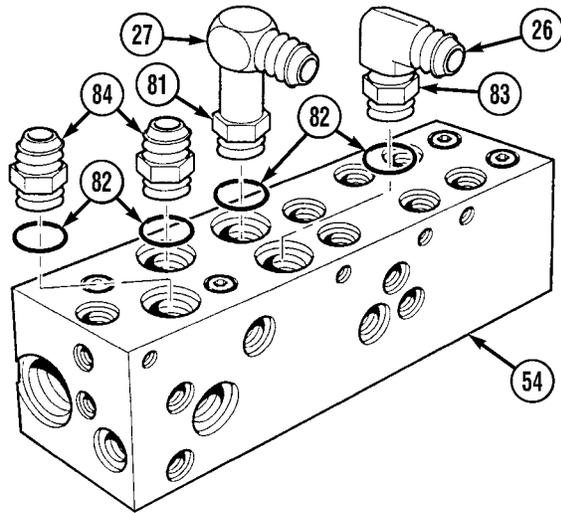

- (40) Remove four plugs (68) and preformed packings (69) from hydraulic manifold (54). Discard preformed packings.

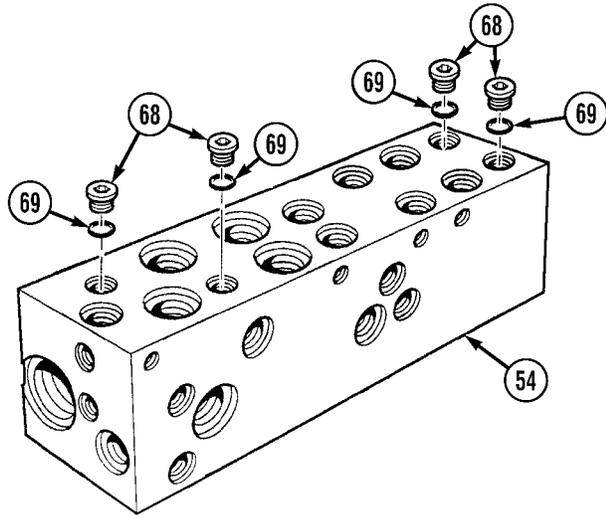

- (41) Remove plug (75) and preformed packing (76) from hydraulic manifold (54). Discard preformed packings.

Direct Support and General Support Maintenance (Cont)

- (42) Remove plug (68) and preformed packing (69) from hydraulic manifold (54). Discard preformed packing.
- (43) Remove plug (62) and preformed packing (63) from hydraulic manifold (54). Discard preformed packing.
- (44) Remove plug (64) and preformed packing (65) from hydraulic manifold (54). Discard preformed packing.

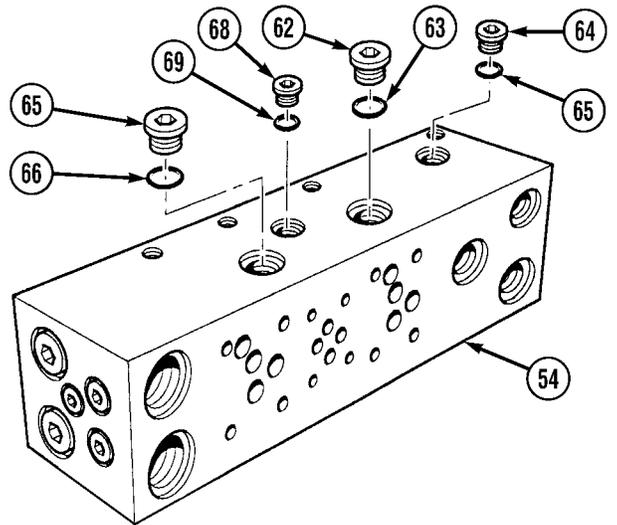

- (45) Remove two plugs (66) and preformed packings (67) from hydraulic manifold (54). Discard preformed packings.
- (46) Remove plug (64) and preformed packing (65) from hydraulic manifold (54). Discard preformed packing.
- (47) Remove two plugs (75) and preformed packings (76) from hydraulic manifold (54). Discard preformed packings.

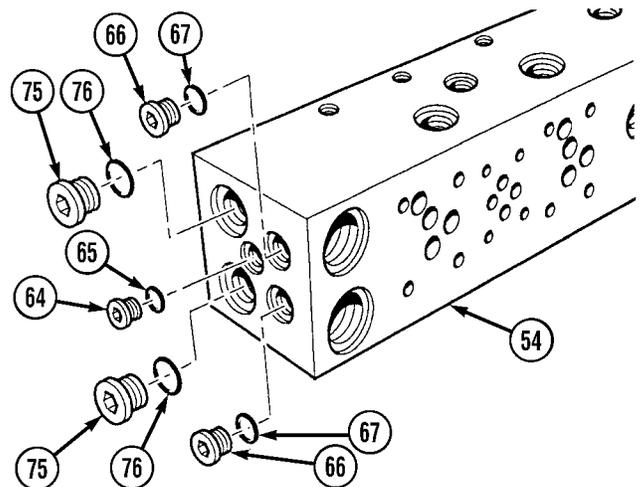

Direct Support and General Support Maintenance (Cont)

5-31. LOAD HANDLING SYSTEM (LHS) MAIN MANIFOLD/BRACKET REPLACEMENT (CONT).

b. Installation.

- (1) Apply hydraulic oil to two preformed packings (1).
- (2) Install two preformed packing (1) and plugs (2) on hydraulic manifold (3). Tighten to 15 lb-ft. (20 N•m).
- (3) Apply hydraulic oil to preformed packing (4).
- (4) Install preformed packing (4) and plug (5) on hydraulic manifold (3). Tighten to 8 lb-ft. (11 N•m).
- (5) Apply hydraulic oil to two preformed packings (6).
- (6) Install two preformed packings (6) and plugs (7) on hydraulic manifold (3). Tighten to 15 lb-ft. (20 N•m).

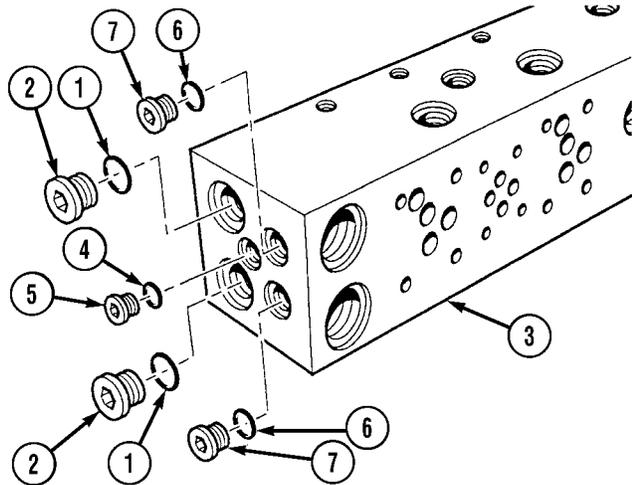

- (7) Apply hydraulic oil to preformed packing (1).
- (8) Install two preformed packings (1) and plugs (2) on hydraulic manifold (3). Tighten to 15 lb-ft. (20 N•m).
- (9) Apply hydraulic oil to preformed packing (4).
- (10) Install preformed packing (4) and plug (5) on hydraulic manifold (3). Tighten to 8 lb-ft. (11 N•m).
- (11) Apply hydraulic oil to preformed packing (8).
- (12) Install preformed packing (8) and plug (9) on hydraulic manifold (3). Tighten to 30 lb-ft. (41 N•m).
- (13) Apply hydraulic oil to preformed packing (4).
- (14) Apply hydraulic oil to preformed packing (10).
- (15) Install preformed packing (10) and plug (11) on hydraulic manifold (3). Tighten to 5 lb-ft. (7 N•m).

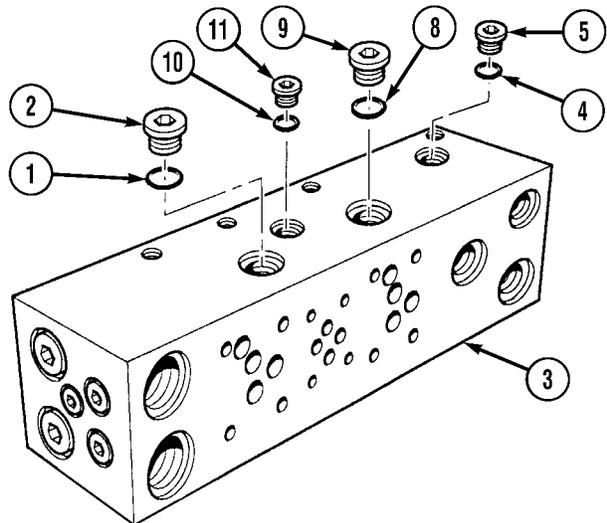

Direct Support and General Support Maintenance (Cont)

- (16) Apply hydraulic oil to four preformed packings (12).
- (17) Install four preformed packings (12) and plugs (13) on hydraulic manifold (3). Tighten to 11 lb-ft. (15 N•m).

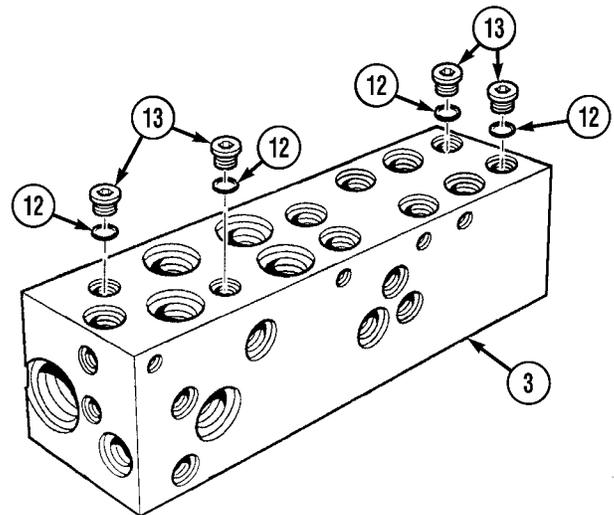

- (18) Apply hydraulic oil to two preformed packings (14).
- (19) Install two preformed packings (14) and fittings (15) on hydraulic manifold (3).
- (20) Apply hydraulic oil to preformed packing (14).
- (21) Install preformed packing (14) and elbow (16) on hydraulic manifold (3) and tighten nut (17).
- (22) Apply hydraulic oil to preformed packing (14).
- (23) Install preformed packing (14) and elbow (18) on hydraulic manifold (3) and tighten nut (19).

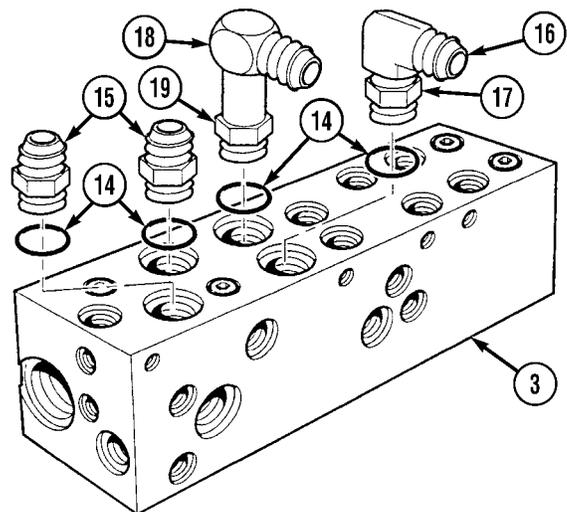

- (24) Apply hydraulic oil to three preformed packings (20).
- (25) Install three preformed packings (20) and elbows (21, 22, and 23) and tighten nuts (24).
- (26) Apply hydraulic oil to three preformed packings (20).
- (27) Install three preformed packings (20) and elbows (25, 26, and 27) and tighten nuts (28).

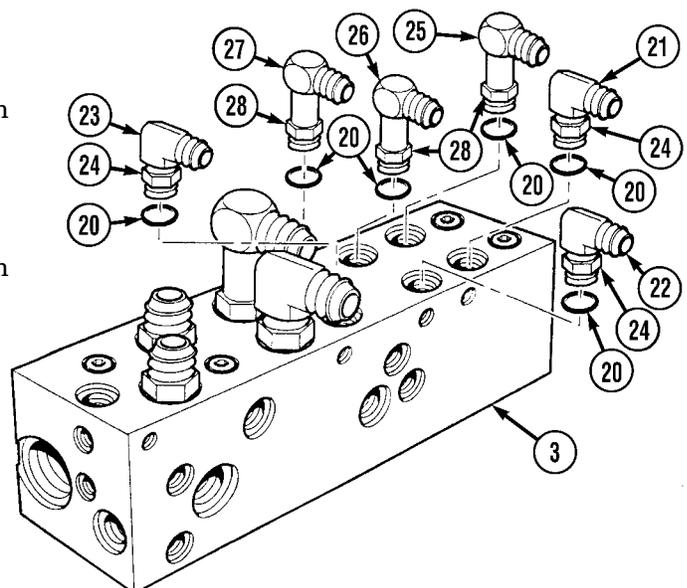

Direct Support and General Support Maintenance (Cont)

5-31. LOAD HANDLING SYSTEM (LHS) MAIN MANIFOLD/BRACKET REPLACEMENT (CONT).

- (28) Apply hydraulic oil to two preformed packings (10).
- (29) Install two preformed packings (10) and plugs (11) on hydraulic manifold (3). Tighten to 5 lb-ft. (7 N•m).
- (30) Apply hydraulic oil to preformed packing (1).
- (31) Install preformed packing (1) and plug (2) on hydraulic manifold (3). Tighten to 15 lb-ft. (20 N•m).
- (32) Install orifice plug (29) on hydraulic manifold (3).

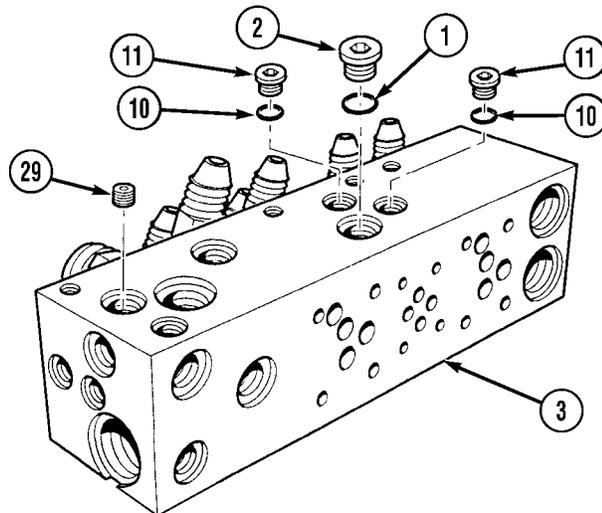

- (33) Apply hydraulic oil to preformed packing (10).
- (34) Install preformed packing (10) and plug (11) on hydraulic manifold (3). Tighten to 5 lb-ft. (7 N•m).
- (35) Apply hydraulic oil to preformed packing (4).
- (36) Install preformed packing (4) and plug (5) on hydraulic manifold (3). Tighten to 8 lb-ft. (11 N•m).
- (37) Apply hydraulic oil to preformed packings (30, 31, and 32).
- (38) Install preformed packings (30, 31, and 32), check valve (33), and plug (34) on hydraulic manifold (3). Tighten to 8 lb-ft. (11 N•m).
- (39) Apply hydraulic oil to preformed packing (12).
- (40) Install preformed packing (12) and plug (13) on hydraulic manifold.

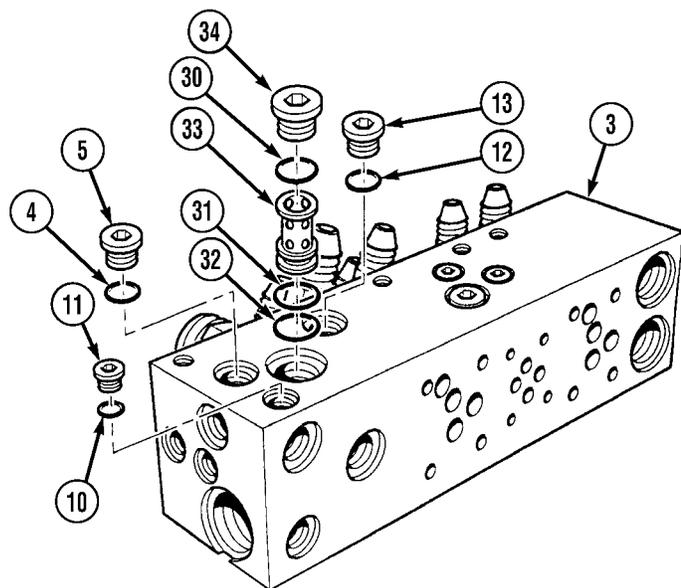

Direct Support and General Support Maintenance (Cont)

- (41) Apply hydraulic oil to preformed packing (8).
- (42) Install preformed packing (8) and plug (9) on hydraulic manifold (3). Tighten to 30 lb-ft. (41 N•m).
- (43) Apply hydraulic oil to two preformed packings (4).
- (44) Install two preformed packings (4) and plugs (5) on hydraulic manifold (3). Tighten to 8 lb-ft. (11 N•m).
- (45) Apply hydraulic oil to preformed packing (10).
- (46) Install preformed packing (10) and plug (11) on hydraulic manifold (3). Tighten to 5 lb-ft. (7 N•m).
- (47) Apply hydraulic oil to preformed packings (35 and 36).
- (48) Install preformed packings (35 and 36) and switch (37) on hydraulic manifold (3). Tighten to 20 lb-ft. (27 N•m).
- (49) Install hydraulic manifold (3) on left and right LHS main manifold bracket assembly (38) with eight lockwashers (39) and screws (40).

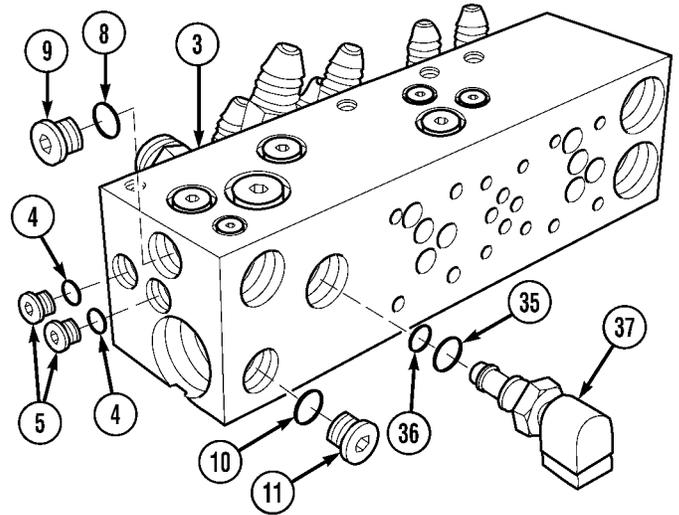

WARNING

Adhesives, solvents, and sealing compounds can burn easily, can give off harmful vapors and are harmful to skin and clothing. To avoid injury or death, keep away from open fire and use in a well-ventilated area. If adhesive, solvent, or sealing compound gets on skin or clothing, wash immediately with soap and water.

- (50) Coat threads of screws (45) with sealing compound.
- (51) Install two spacers (42), washers (43), lockwashers (44), and screws (45) on LHS main manifold bracket assembly (38). Tighten to 13 lb-ft. (17 N•m).
- (52) Install LHS main junction box (46) on bracket (38) with four locknuts (47) and screws (48). Tighten to 21 lb-in. (3 N•m).
- (53) Install junction box cover (49) on LHS main junction box (46) and tighten screws (50).

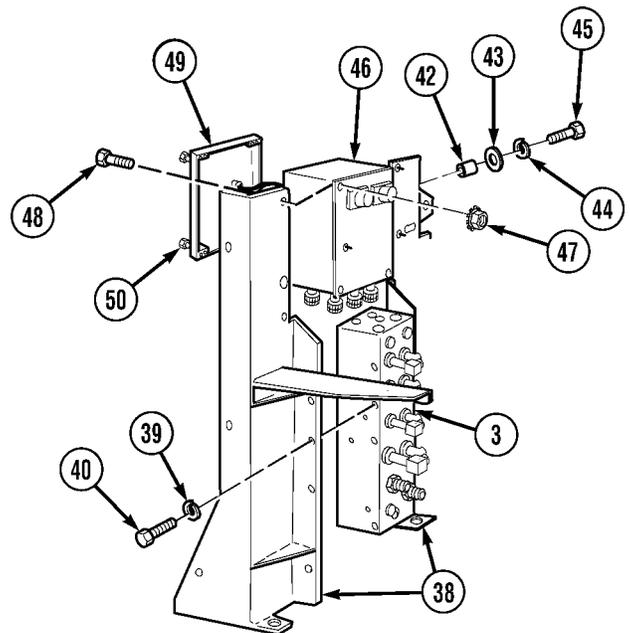

Direct Support and General Support Maintenance (Cont)

5-31. LOAD HANDLING SYSTEM (LHS) MAIN MANIFOLD/BRACKET REPLACEMENT (CONT).

- (54) Install elbows (51 and 52) on bracket (53) with nuts (54).
- (55) Apply hydraulic oil to two preformed packings (55).
- (56) Install two preformed packings (55), fittings (56), and couplings (57 and 58) on elbows (51 and 52).

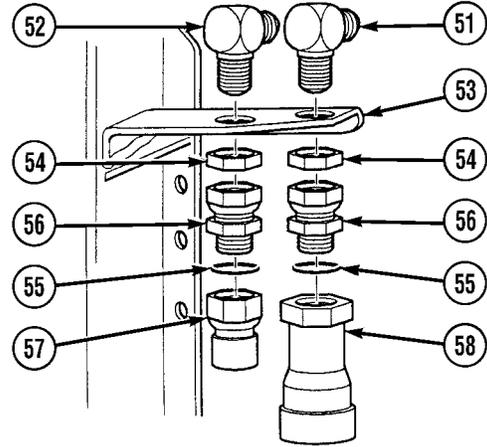

- (57) Install oil tube (59) on fitting (60) and elbow (52).
- (58) Install oil tube (61) on fitting (62) and elbow (51).
- (59) Install brackets (63 and 64) with screws (65) and two locknuts (66). Tighten to 23 lb-ft. (31 N•m).

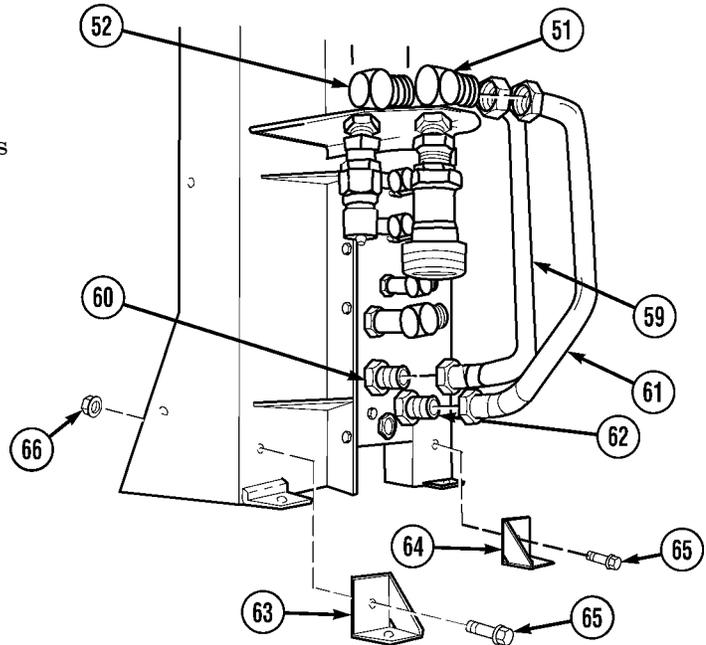

Direct Support and General Support Maintenance (Cont)

WARNING

Bracket weighs 120 lbs. (54 kg). Attach suitable lifting device prior to installation to prevent possible injury to personnel.

- (60) Attach lifting device to LHS main manifold bracket (38).
- (61) Position LHS main manifold bracket assembly (38) on mounting bracket (67).
- (62) Install two screws (68), screws (69) and four locknuts (70) on bracket (38) and fender (67). Tighten to 23 lb-ft. (31 N•m).
- (63) Remove lifting device from bracket (38).
- (64) Install hose 2892 (71) and hose 2891 (72) on elbows (73 and 74).
- (65) Install hose 2890 (75) and hose 2889 (76) on elbows (77 and 78).

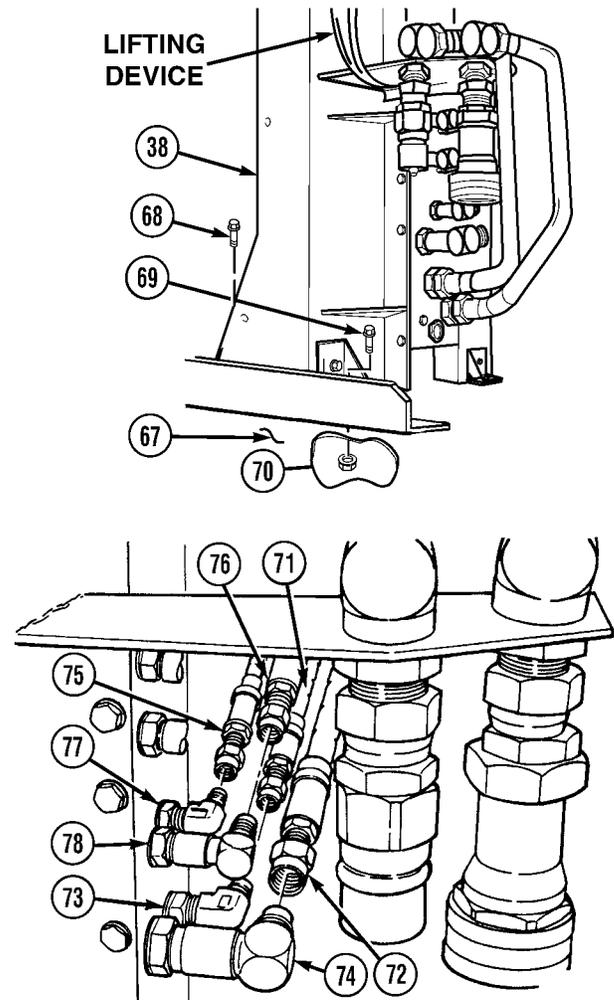

Direct Support and General Support Maintenance (Cont)

5-31. LOAD HANDLING SYSTEM (LHS) MAIN MANIFOLD/BRACKET REPLACEMENT (CONT).

- (66) Install hose 2888 (79) and hose 2588 (80) on elbows (81 and 82).
- (67) Install hose 2887 (83) and hose 2588 (84) on elbows (85 and 86).

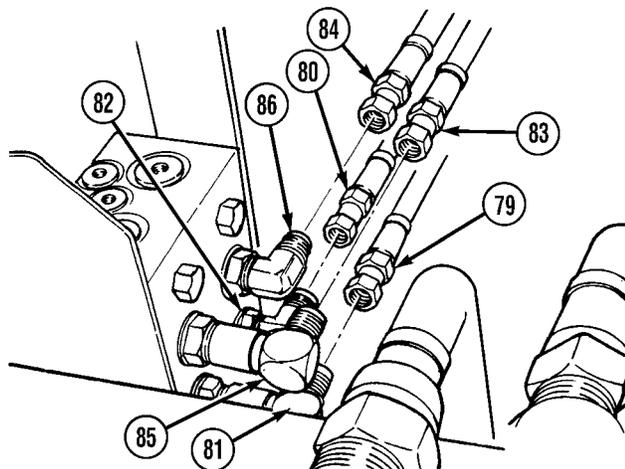

- (68) Install couplings (87 and 88) on fittings (89 and 90).

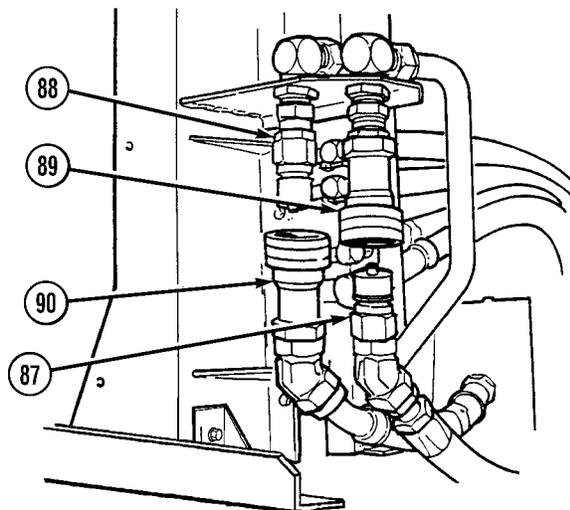

- (69) Connect MC82 connector (91) and MC85 connector (92) on LHS main junction box (46).

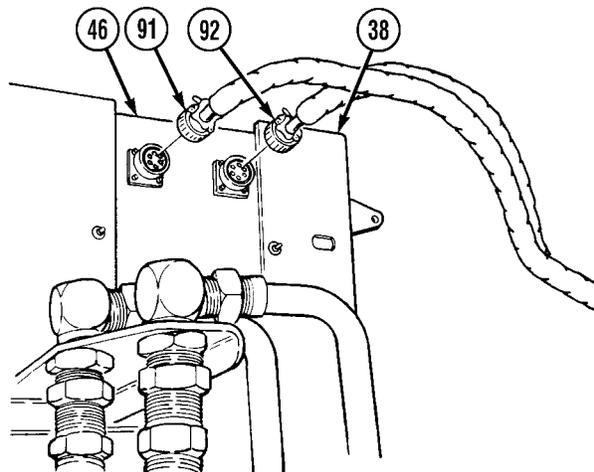

Direct Support and General Support Maintenance (Cont)

- (70) Install LHS control box cover (93), four lockwashers (94), and screws (95) on LHS main manifold bracket assembly (38).

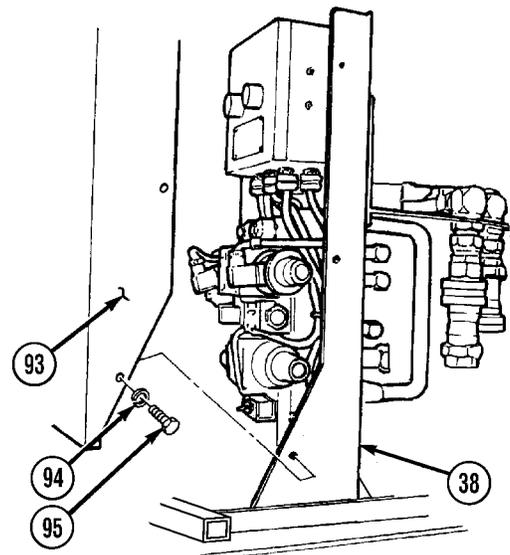
**c. Follow-on Maintenance.**

- (1) Install LHS transit valve (Para 5-32).
- (2) Install LHS directional control valve (Para 5-35).
- (3) Install LHS solenoid valve and coil (Para 5-34).
- (4) Install LHS main manifold relief valve (Para 5-33).
- (5) Install LHS check valve (Para 5-42).
- (6) Install LHS main manifold load control valve (Para 5-41).
- (7) Connect batteries (TM 9-2320-279-20).
- (8) Start engine (TM 9-2320-279-10).
- (9) Check for oil leaks (TM 9-2320-279-10).
- (10) Shut off engine (TM 9-2320-279-10).
- (11) Remove wheel chocks (TM 9-2320-279-10).

END OF TASK

Direct Support and General Support Maintenance (Cont)

5-32. LOAD HANDLING SYSTEM (LHS) TRANSIT VALVE REPLACEMENT.										
This task covers:										
a. Removal	b. Installation	c. Follow-on Maintenance								
INITIAL SETUP										
<i>Models</i> M1120	<i>Personnel Required</i> MOS 63W, Wheel vehicle repairer									
<i>Test Equipment</i> None	<i>References</i> None									
<i>Special Tools</i> Tool Kit, General Mechanic's, Item 32, Appendix B Pan, Drain 4 gal, Item 16, Appendix B	<i>Equipment Condition</i> <table border="0"> <thead> <tr> <th><i>TM or Para</i></th> <th><i>Condition Description</i></th> </tr> </thead> <tbody> <tr> <td>Para 2-9</td> <td>LHS in transit position</td> </tr> <tr> <td>TM 9-2320-279-10</td> <td>Engine OFF</td> </tr> <tr> <td>TM 9-2320-279-10</td> <td>Wheels chocked</td> </tr> </tbody> </table>		<i>TM or Para</i>	<i>Condition Description</i>	Para 2-9	LHS in transit position	TM 9-2320-279-10	Engine OFF	TM 9-2320-279-10	Wheels chocked
<i>TM or Para</i>	<i>Condition Description</i>									
Para 2-9	LHS in transit position									
TM 9-2320-279-10	Engine OFF									
TM 9-2320-279-10	Wheels chocked									
<i>Supplies</i> Oil, Hydraulic, Item 12, Appendix F Adhesive, Item 1, Appendix F Lockwasher (4), Item 17, Appendix K Preformed Packing Kit, Item 34, Appendix K	<i>Special Environmental Conditions</i> None									
	<i>General Safety Instructions</i> None									

Direct Support and General Support Maintenance (Cont)

a. Removal.

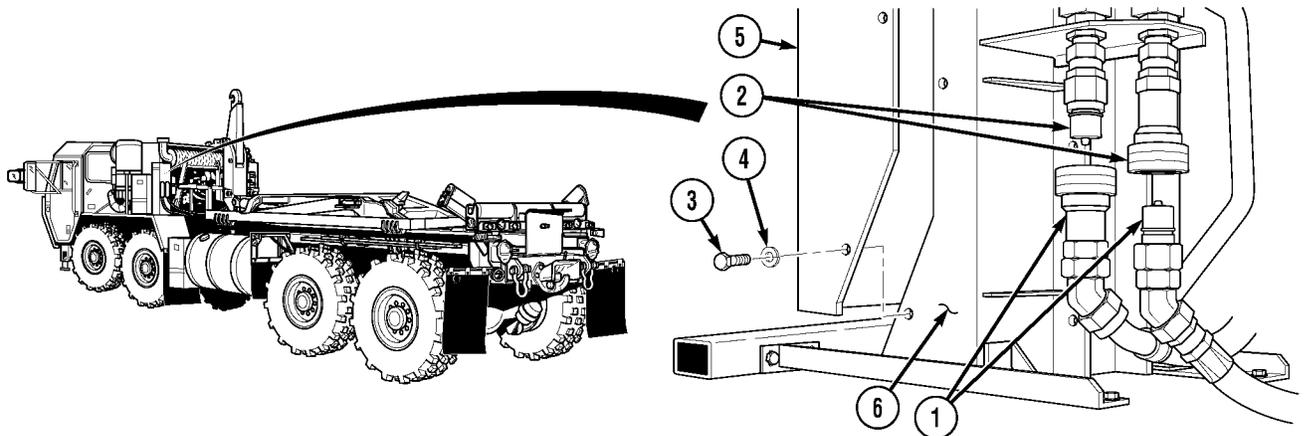

WARNING

The LHS hydraulic system operates at oil pressures up to 1,725 psi (11 894 kPa). Never disconnect any hydraulic line or fitting without first dropping pressure to zero. Failure to comply may result in serious injury or death to personnel.

- (1) Disconnect two hose quick disconnects (1) from LHS control box quick disconnects (2).

NOTE

Only remove center screw on engine side of LHS main junction box cover.

- (2) Remove four screws (3), lockwashers (4), and LHS main junction box cover (5) from bracket (6). Discard lockwashers.

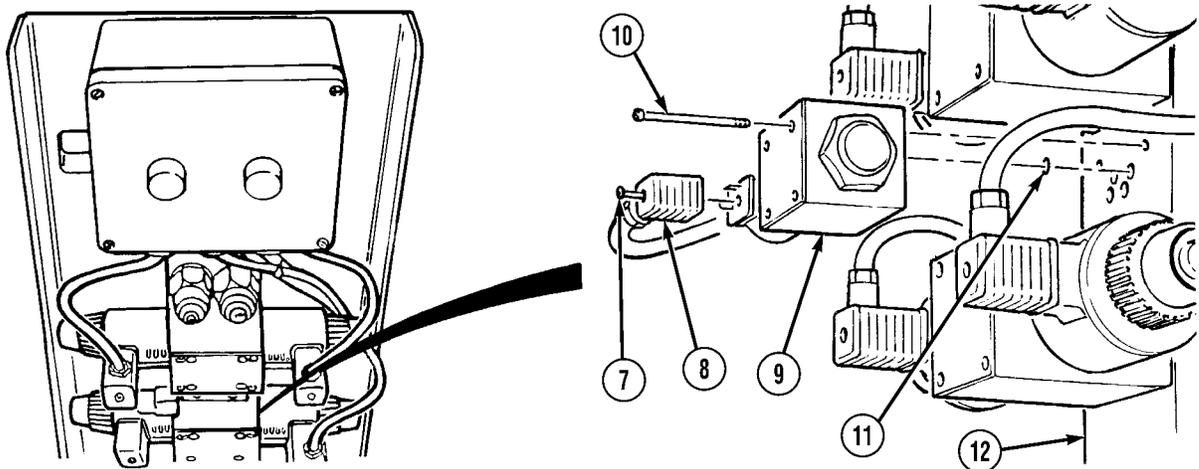

- (3) Loosen captive screw (7) and remove connector (8) from transit valve (9).
- (4) Position drain pan under transit valve (9).
- (5) Remove four screws (10), transit valve (9), and four preformed packings (11) from hydraulic manifold (12). Discard preformed packings.

Direct Support and General Support Maintenance (Cont)

5-32. LOAD HANDLING SYSTEM (LHS) TRANSIT VALVE REPLACEMENT (CONT).

b. Installation

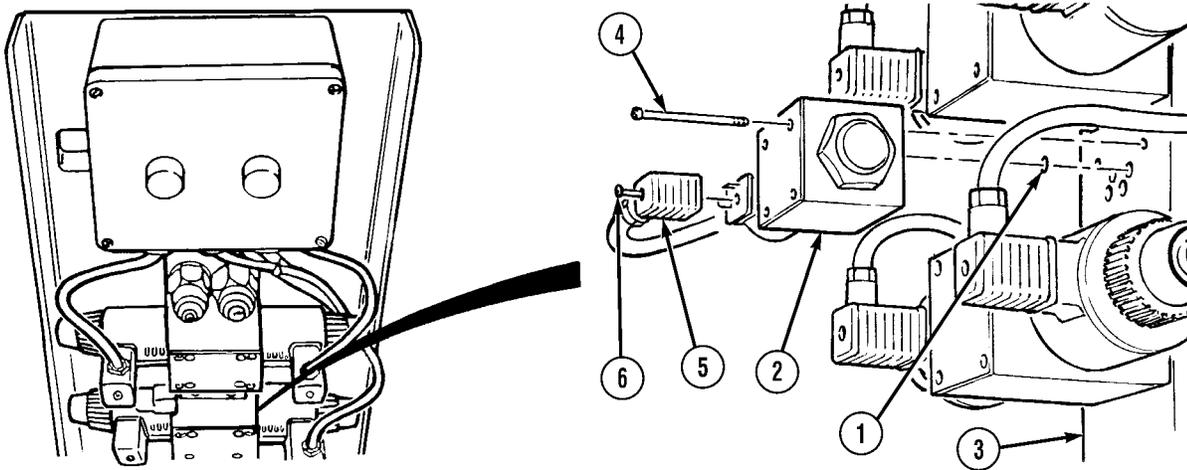

- (1) Apply hydraulic oil to four preformed packings (1).
- (2) Install four preformed packings (1) on transit valve (2).
- (3) Install transit valve (2) on hydraulic manifold (3) with four screws (4).
- (4) Install connector (5) on transit valve (2) and tighten screw (6).

WARNING

Adhesives, solvents, and sealing compound can burn easily, can give off harmful vapors, and are harmful to skin and clothing. To avoid injury or death, keep away from open fire and use in a well-ventilated area. If adhesive, solvent, or sealing compound gets on skin or clothing, wash immediately with soap and water.

- (5) Apply sealing compound to head of screw (6).
- (6) Install LHS control box cover (7) on bracket (8) with four lockwashers (9) and screws (10).
- (7) Connect two hose quick disconnects (11) on main junction box quick disconnects (12).

c. Follow-on Maintenance.

- (1) Start engine (TM 9-2320-279-10).
- (2) Operate LHS (Para 2-9).
- (3) Check for oil leaks (TM 9-2320-279-10).
- (4) Shut OFF engine (TM 9-2320-279-10).
- (5) Check hydraulic oil reservoir level (TM 9-2320-279-10).
- (6) Remove wheel chocks (TM 9-2320-279-10).

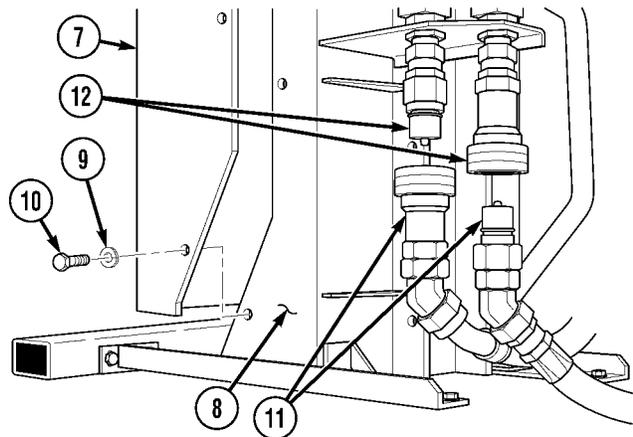

END OF TASK

Direct Support and General Support Maintenance (Cont)

5-33. LOAD HANDLING SYSTEM (LHS) MAIN MANIFOLD RELIEF VALVE REPLACEMENT.										
This task covers:										
a. Removal	b. Installation	c. Follow-on Maintenance								
INITIAL SETUP										
<i>Models</i> M1120	<i>Personnel Required</i> MOS 63W, Wheel vehicle repairer (2)									
<i>Test Equipment</i> None	<i>References</i> None									
<i>Special Tools</i> Tool Kit, General Mechanic's, Item 32, Appendix B Pan, Drain 4 gal, Item 16, Appendix B Wrench, Torque (0 to 175 lb-ft. [0-237 N•m]), Item 48, Appendix B Wooden Block (2), Appendix H	<i>Equipment Condition</i> <table border="0"> <tr> <td><i>TM or Para</i></td> <td><i>Condition Description</i></td> </tr> <tr> <td>Para 2-9</td> <td>LHS in transit position</td> </tr> <tr> <td>TM 9-2320-279-10</td> <td>Engine OFF</td> </tr> <tr> <td>TM 9-2320-279-10</td> <td>Wheels chocked</td> </tr> </table>		<i>TM or Para</i>	<i>Condition Description</i>	Para 2-9	LHS in transit position	TM 9-2320-279-10	Engine OFF	TM 9-2320-279-10	Wheels chocked
<i>TM or Para</i>	<i>Condition Description</i>									
Para 2-9	LHS in transit position									
TM 9-2320-279-10	Engine OFF									
TM 9-2320-279-10	Wheels chocked									
<i>Supplies</i> Oil, Hydraulic, Item 12, Appendix F Locknut (4), Item 11, Appendix K Lockwasher (4), Item 17, Appendix K Lockwasher (2), Item 20, Appendix K Preformed Packing Kit, Item 39, Appendix K	<i>Special Environmental Conditions</i> None									
	<i>General Safety Instructions</i> None									

Direct Support and General Support Maintenance (Cont)

5-33. LOAD HANDLING SYSTEM (LHS) MAIN MANIFOLD RELIEF VALVE REPLACEMENT (CONT).

a. Removal.

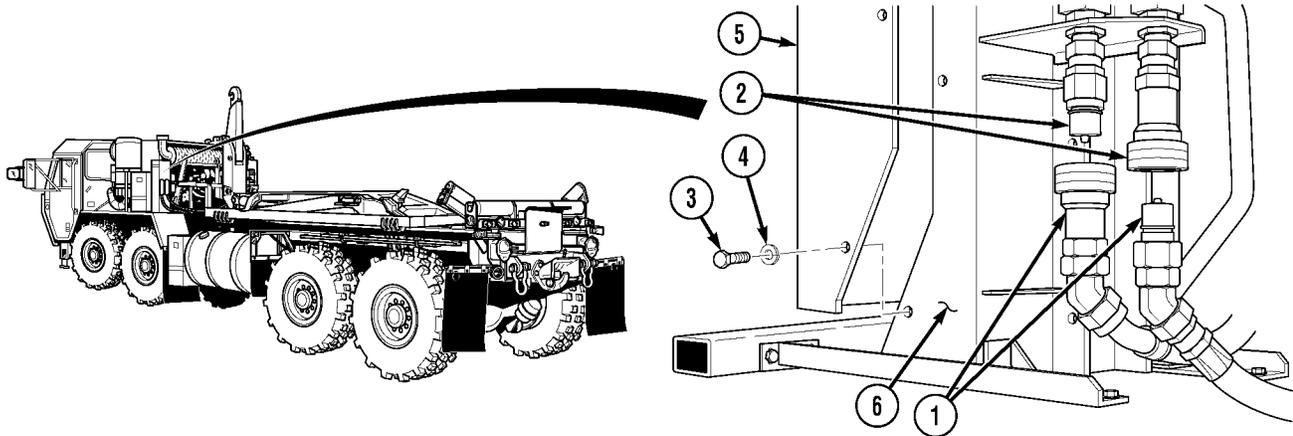

WARNING

The LHS hydraulic system operates at oil pressures up to 1,725 psi (11 894 kPa). Never disconnect any hydraulic line or fitting without first dropping pressure to zero. Failure to comply may result in serious injury or death to personnel.

- (1) Disconnect two hose quick disconnects (1) from main junction box quick disconnects (2).

NOTE

Only remove center screw on engine side of LHS control box cover.

- (2) Remove four screws (3), lockwashers (4), and LHS control box cover (5) from bracket (6). Discard lockwashers.

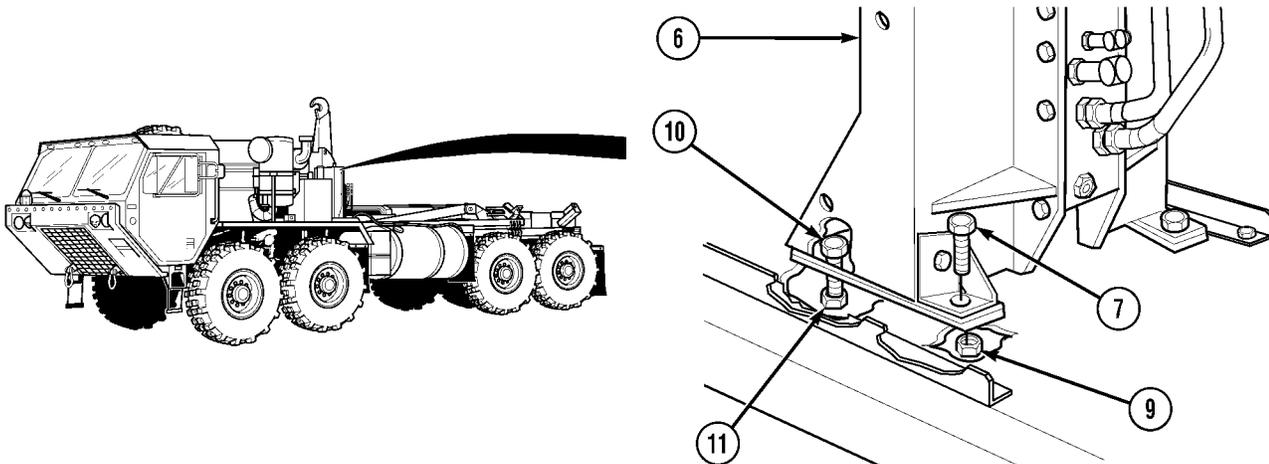

- (3) Remove two screws (7) and locknuts (9) from bracket (6). Discard locknuts.
- (4) Loosen two screws (10) and locknuts (11) on bracket (6) approximately six turns.

Direct Support and General Support Maintenance (Cont)

- (5) Push on top of bracket (6) towards front of truck enough to lift rear of bracket (6) approximately 2 in. (5.08 cm), and place two wooden blocks under bracket (6).
- (6) Position drain pan under relief valve (12).
- (7) Remove relief valve (12) from manifold (13).

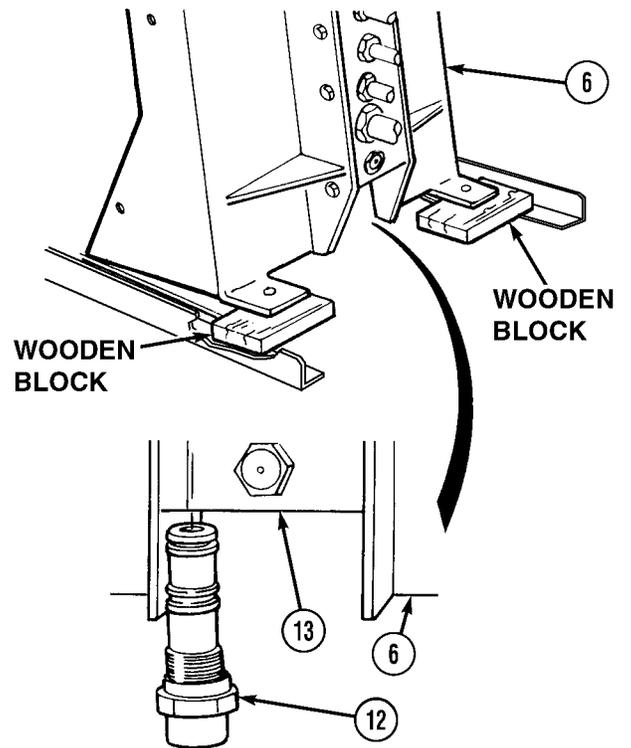

- (8) Remove two backup rings (14), preformed packing (15), two backup rings (16), preformed packing (17), and preformed packing (18) from relief valve (12). Discard backup rings and preformed packings.

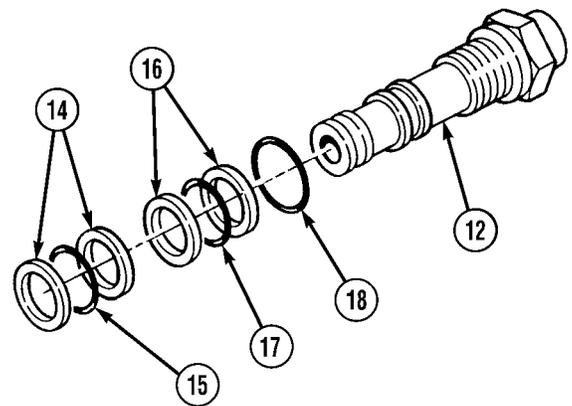

Direct Support and General Support Maintenance (Cont)

5-33. LOAD HANDLING SYSTEM (LHS) MAIN MANIFOLD RELIEF VALVE REPLACEMENT (CONT).

b. Installation.

- (1) Apply hydraulic oil to preformed packings (1 and 2) and two backup rings (3 and 4).
- (2) Install preformed packing (2), preformed packing (1), two backup rings (4), preformed packing (5), and two backup rings (3) on relief valve (6).

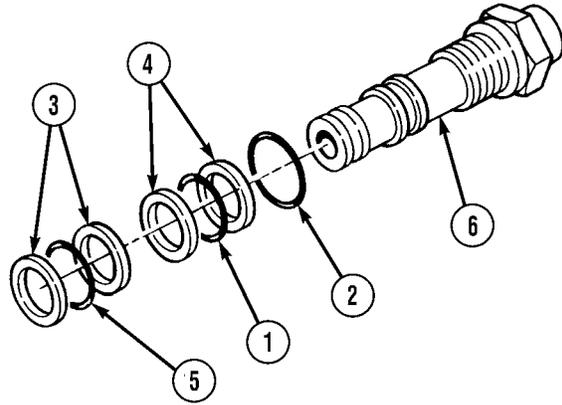

- (3) Install relief valve (6) in hydraulic manifold (7). Tighten relief valve to 65 lb-ft. (88 N•m).
- (4) Push on top of bracket (8) and remove two wooden blocks. Lower bracket (8).

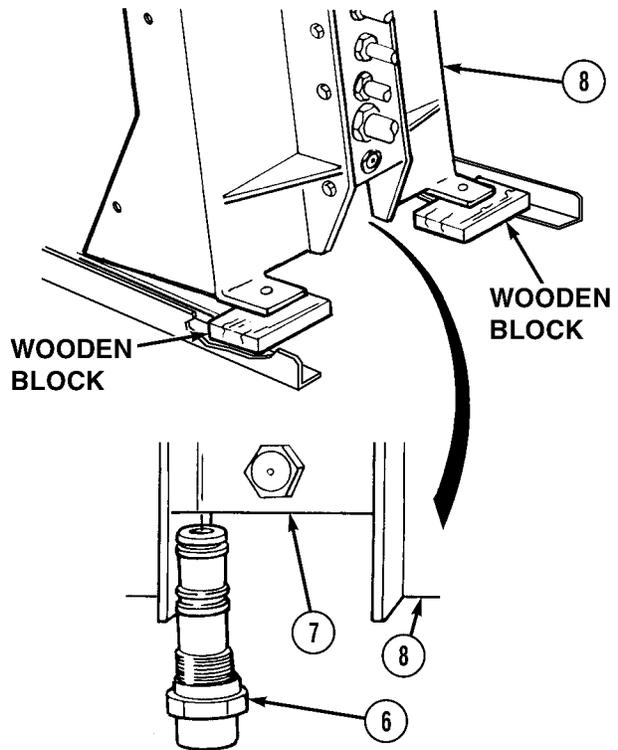

Direct Support and General Support Maintenance (Cont)

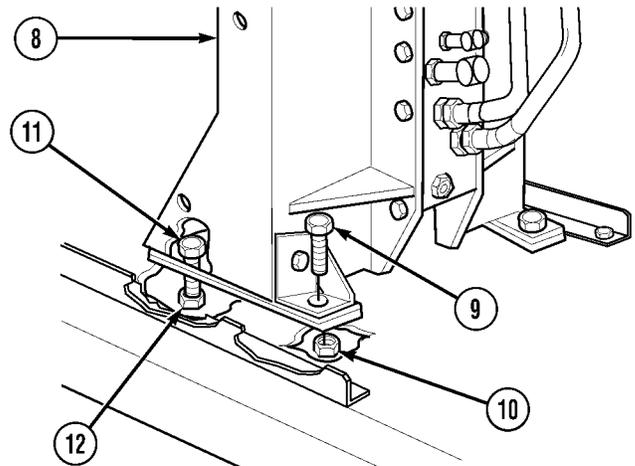
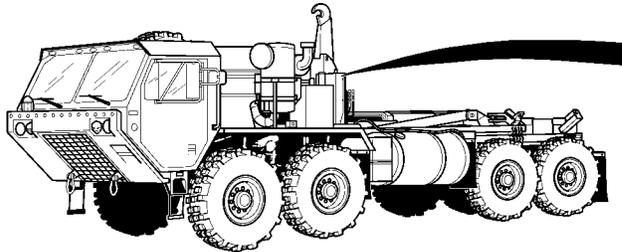

- (5) Install two screws (9) and locknuts (10) on bracket (8).
- (6) Remove two screws (11) and locknuts (12) from bracket (8). Discard locknuts.
- (7) Install two screws (11) and locknuts (12) on bracket (8).
- (8) Install LHS control box cover (13) on bracket (8) with four lockwashers (14) and screws (15).
- (9) Connect two hose quick disconnects (16) on control box quick disconnects (17).

c. Follow-on Maintenance.

- (1) Start engine (TM 9-2320-279-10).
- (2) Operate LHS (Para 2-9).
- (3) Check for leaks (TM 9-2320-279-10).
- (4) Shut OFF engine (TM 9-2320-279-10).
- (5) Check hydraulic oil reservoir level (TM 9-2320-279-20).
- (6) Remove wheel chocks (TM 9-2320-279-10).

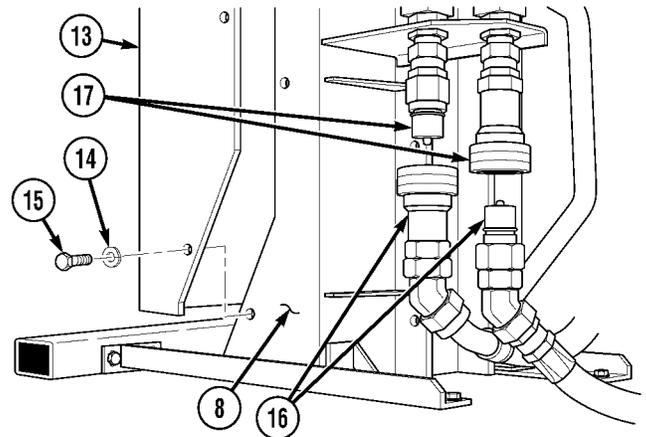
**END OF TASK**

Direct Support and General Support Maintenance (Cont)

<p>5-34. LOAD HANDLING SYSTEM (LHS) MAIN MANIFOLD SOLENOID VALVE AND COIL REPAIR.</p>										
<p>This task covers:</p>										
a. Removal	b. Installation	c. Follow-on Maintenance								
<p>INITIAL SETUP</p>										
<p><i>Models</i> M1120</p>	<p><i>Personnel Required</i> MOS 63W, Wheel vehicle repairer</p>									
<p><i>Test Equipment</i> None</p>	<p><i>References</i> None</p>									
<p><i>Special Tools</i> Tool Kit, General Mechanic's, Item 32, Appendix B Pan, Drain 4 gal, Item 16, Appendix B Wrench, Torque (0-175 lb-ft. [0-237 N•m]), Item 48, Appendix B</p>	<p><i>Equipment Condition</i></p> <table border="0"> <tr> <td style="text-align: center;"><i>TM or Para</i></td> <td style="text-align: center;"><i>Condition Description</i></td> </tr> <tr> <td style="text-align: center;">Para 2-9</td> <td style="text-align: center;">LHS in transit position</td> </tr> <tr> <td style="text-align: center;">TM 9-2320-279-10</td> <td style="text-align: center;">Engine OFF</td> </tr> <tr> <td style="text-align: center;">TM 9-2320-279-10</td> <td style="text-align: center;">Wheels chocked</td> </tr> </table>		<i>TM or Para</i>	<i>Condition Description</i>	Para 2-9	LHS in transit position	TM 9-2320-279-10	Engine OFF	TM 9-2320-279-10	Wheels chocked
<i>TM or Para</i>	<i>Condition Description</i>									
Para 2-9	LHS in transit position									
TM 9-2320-279-10	Engine OFF									
TM 9-2320-279-10	Wheels chocked									
<p><i>Supplies</i> Oil, Hydraulic, Item 12, Appendix F Sealing Compound, Item 18, Appendix F Lockwasher (4), Item 17, Appendix K Lockwasher (2), Item 20, Appendix K Preformed Packing Kit, Item 40, Appendix K</p>	<p><i>Special Environmental Conditions</i> None</p>									
	<p><i>General Safety Instructions</i> None</p>									

Direct Support and General Support Maintenance (Cont)

a. Removal.

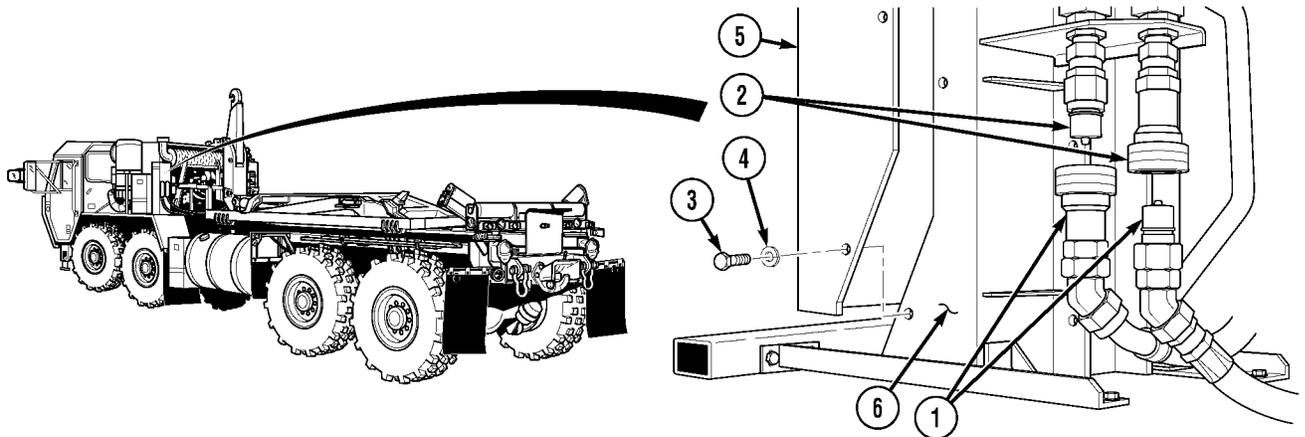

WARNING

The LHS hydraulic system operates at oil pressures up to 1,725 psi (11 894 kPa). Never disconnect any hydraulic line or fitting without first dropping pressure to zero. Failure to comply may result in serious injury or death to personnel.

- (1) Disconnect two hose quick disconnects (1) from main junction box quick disconnects (2).

NOTE

Only remove center screw on engine side of LHS junction box cover.

- (2) Remove four screws (3), lockwashers (4), and LHS main junction box cover (5) from bracket (6). Discard lockwashers.

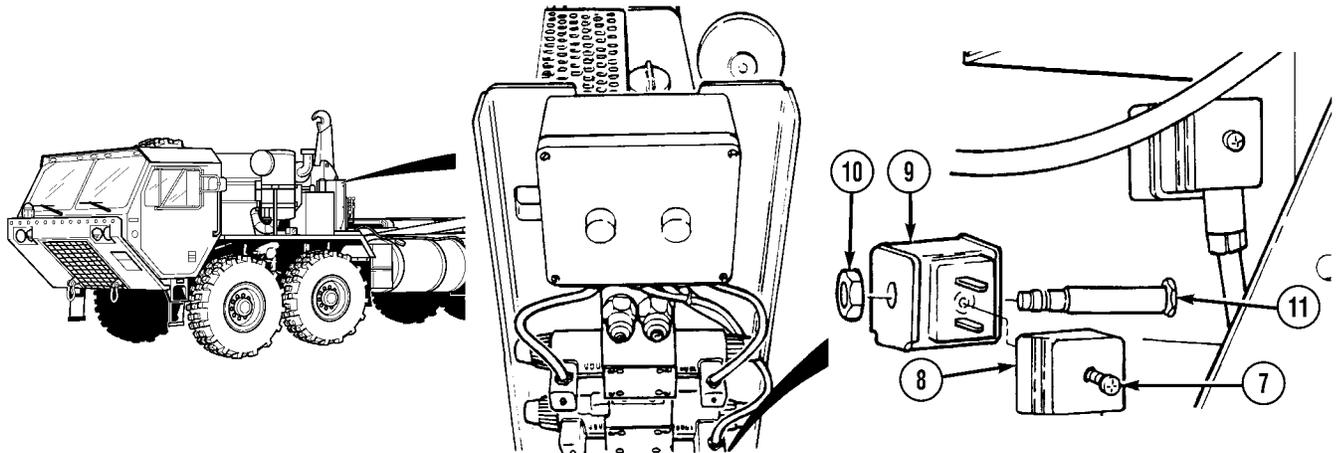

- (3) Loosen screw (7) and connector (8) from solenoid valve coil (9).

NOTE

Proceed to **b. Installation** step (4) if only replacing solenoid valve coil.

- (4) Remove nut (10) and solenoid valve coil (9) from solenoid valve (11).

Direct Support and General Support Maintenance (Cont)

5-34. LOAD HANDLING SYSTEM (LHS) MAIN MANIFOLD SOLENOID VALVE AND COIL REPAIR (CONT).

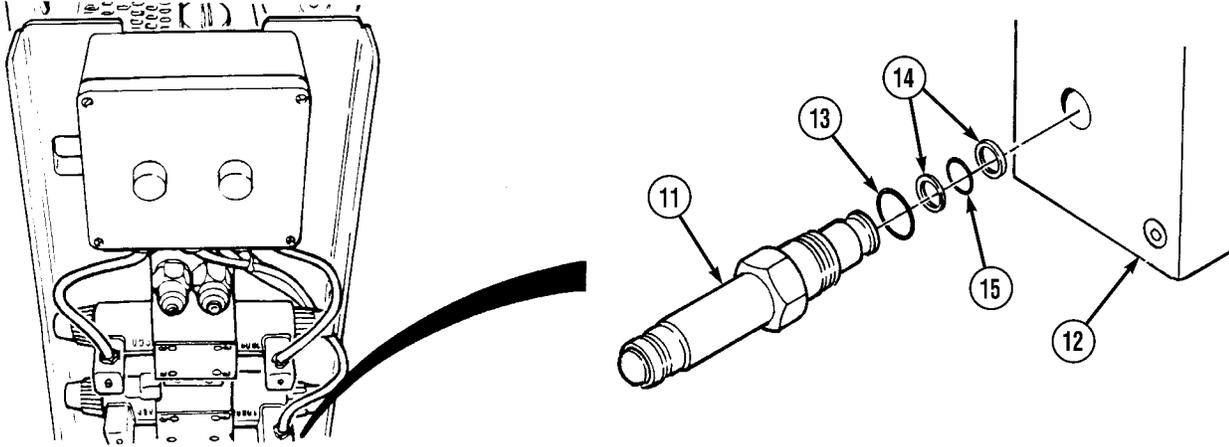

- (5) Position drain pan under solenoid valve (11).
- (6) Remove solenoid valve (11) from hydraulic manifold (12).
- (7) Remove preformed packing (13), two backup rings (14), and preformed packing (15) from solenoid valve (11). Discard preformed packings and backup rings.

b. Installation.

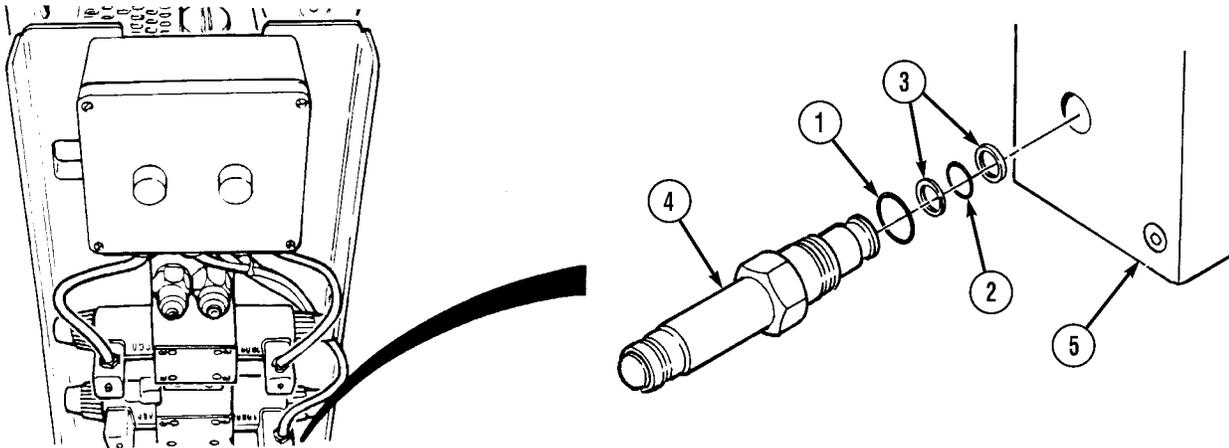

- (1) Coat preformed packings (1 and 2) and two backup rings (3) with hydraulic oil.
- (2) Install preformed packing (2), two backup rings (3), and preformed packing (1) on solenoid valve (4).
- (3) Install solenoid valve (11) in manifold (12) and tighten to 20 lb-ft. (27 N•m).

Direct Support and General Support Maintenance (Cont)

- (4) Install solenoid valve coil (6) on solenoid valve (4) with nut (7).
- (5) Install connector (8) on solenoid valve coil (6) with screw (9).

WARNING

Adhesives, solvents, and sealing compounds can burn easily, can give off harmful vapors, and are harmful to skin and clothing. To avoid injury or death, keep away from open fire and use in well-ventilated area. If adhesive, solvent, or sealing compound gets on skin or clothing, wash immediately with soap and water.

- (6) Apply sealing compound to the head of screw (13).
- (7) Install LHS main junction box cover (10) on bracket (11) with four lockwashers (12) and screws (13).
- (8) Connect two hose quick disconnects (14) on main junction box quick disconnects (15).

c. Follow-on Maintenance.

- (1) Start engine (TM 9-2320-279-10).
- (2) Operate LHS (Para 2-9).
- (3) Check for oil leaks (TM 9-2320-279-10).
- (4) Shut OFF engine (TM 9-2320-279-10).
- (5) Check hydraulic oil reservoir level (TM 9-2320-279-20).
- (6) Remove wheel chocks (TM 9-2320-279-10).

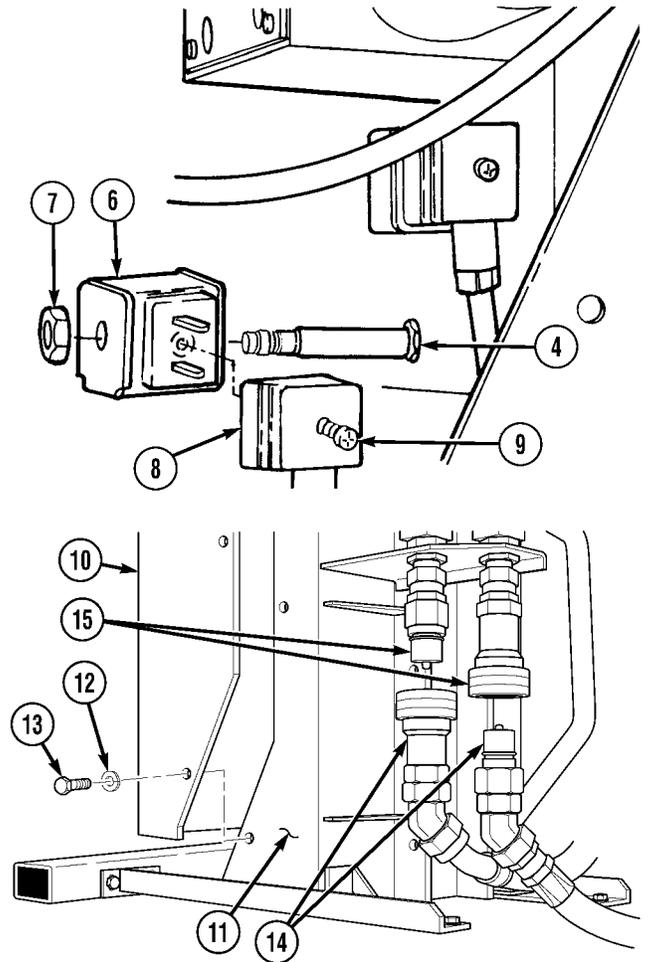
**END OF TASK**

Direct Support and General Support Maintenance (Cont)

<p>5-35. LOAD HANDLING SYSTEM (LHS) DIRECTIONAL CONTROL VALVE REPLACEMENT.</p>										
<p>This task covers:</p>										
a. Removal	b. Installation	c. Follow-on Maintenance								
<p>INITIAL SETUP</p>										
<p><i>Models</i> M1120</p>	<p><i>Personnel Required</i> MOS 63W, Wheel vehicle repairer</p>									
<p><i>Test Equipment</i> None</p>	<p><i>References</i> None</p>									
<p><i>Special Tools</i> Tool Kit, General Mechanic's, Item 32, Appendix B</p>	<p><i>Equipment Condition</i></p> <table border="0"> <tr> <td style="text-align: center;"><i>TM or Para</i></td> <td style="text-align: center;"><i>Condition Description</i></td> </tr> <tr> <td style="text-align: center;">Para 2-9</td> <td style="text-align: center;">LHS in transit position</td> </tr> <tr> <td style="text-align: center;">TM 9-2320-279-10</td> <td style="text-align: center;">Engine OFF</td> </tr> <tr> <td style="text-align: center;">TM 9-2320-279-10</td> <td style="text-align: center;">Wheels chocked</td> </tr> </table>		<i>TM or Para</i>	<i>Condition Description</i>	Para 2-9	LHS in transit position	TM 9-2320-279-10	Engine OFF	TM 9-2320-279-10	Wheels chocked
<i>TM or Para</i>	<i>Condition Description</i>									
Para 2-9	LHS in transit position									
TM 9-2320-279-10	Engine OFF									
TM 9-2320-279-10	Wheels chocked									
<p><i>Supplies</i> Oil, Hydraulic, Item 12, Appendix F Adhesive, Item 1, Appendix F Lockwasher (4), Item 17, Appendix K Preformed Packing Kit, Item 36, Appendix K</p>	<p><i>Special Environmental Conditions</i> None</p>									
	<p><i>General Safety Instructions</i> None</p>									

Direct Support and General Support Maintenance (Cont)

a. Removal.

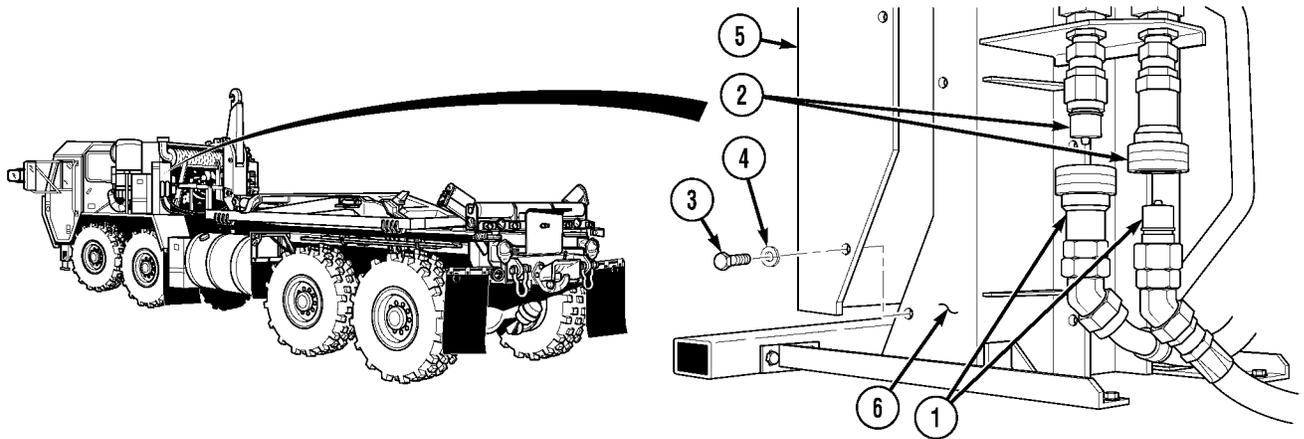

WARNING

The LHS hydraulic system operates at oil pressures up to 1,725 psi (11 894 kPa). Never disconnect any hydraulic line or fitting without first dropping pressure to zero. Failure to comply may result in serious injury or death to personnel.

- (1) Disconnect two hose quick disconnects (1) from main junction control box quick disconnects (2).

NOTE

Only remove center screw on engine side of LHS control box cover.

- (2) Remove four screws (3), lockwashers (4), and LHS control box cover (5) from bracket (6). Discard lockwashers.

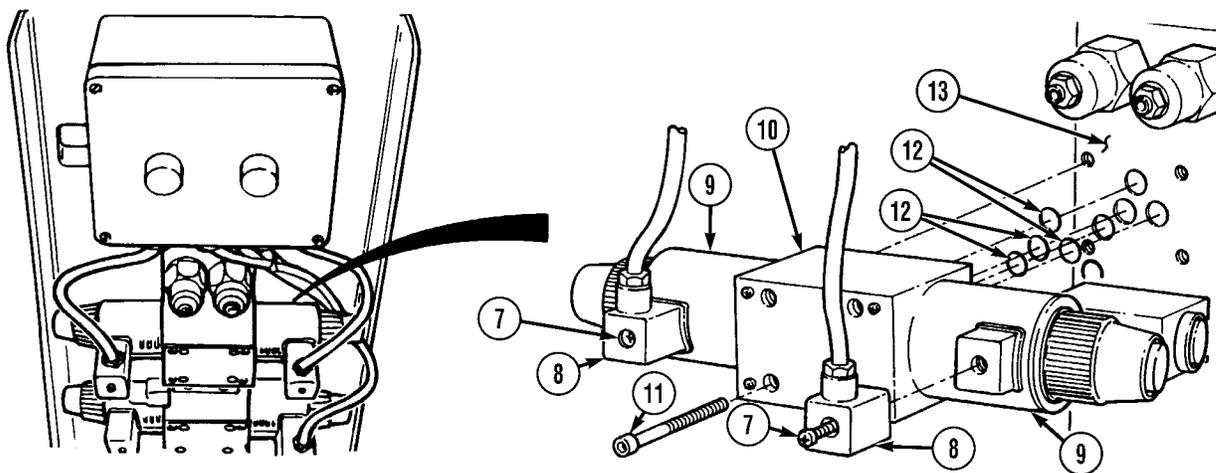

- (3) Loosen screw (7) and connector (8) from solenoid valve coil (9).
- (4) Position drain pan under directional control valve (10).
- (5) Remove four screws (11), directional control valve (10), and five preformed packings (12) from hydraulic manifold (13). Discard preformed packings.

Direct Support and General Support Maintenance (Cont)

5-35. LOAD HANDLING SYSTEM (LHS) DIRECTIONAL CONTROL VALVE REPLACEMENT (CONT).

b. Installation.

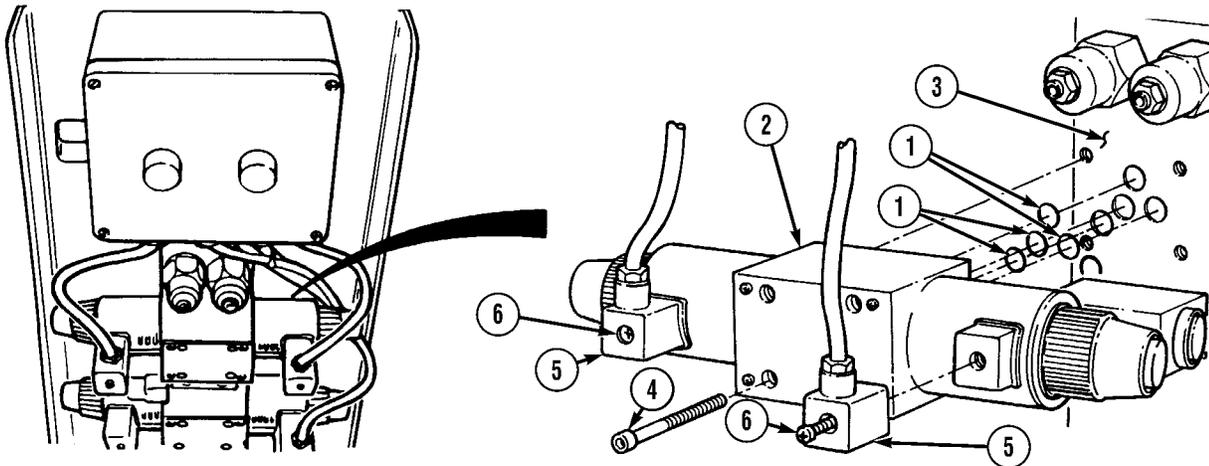

- (1) Apply hydraulic oil to five preformed packings (1).
- (2) Install five preformed packings (1) on directional control valve (2).
- (3) Install directional control valve (2) on hydraulic manifold (3) with four screws (4).
- (4) Install two connectors (5) with screws (6).

WARNING

Adhesives, solvents, and sealing compounds can burn easily, can give off harmful vapors, and are harmful to skin and clothing. To avoid injury or death, keep away from open fire and use in well-ventilated area. If adhesive, solvent, or sealing compound gets on skin or clothing, wash immediately with soap and water.

- (5) Apply sealing compound to heads of screws (6).
- (6) Install LHS control box cover (7) on bracket (8) with four lockwashers (9) and screws (10).
- (7) Connect two hose quick disconnects (11) on main junction box quick disconnects (12).

c. Follow-on Maintenance.

- (1) Start engine (TM 9-2320-279-10).
- (2) Operate LHS (Para 2-9).
- (3) Check for oil leaks (TM 9-2320-279-10).
- (4) Shut OFF engine (TM 9-2320-279-10).
- (5) Check hydraulic oil reservoir level (TM 9-2320-279-20).
- (6) Remove wheel chocks (TM 9-2320-279-10).

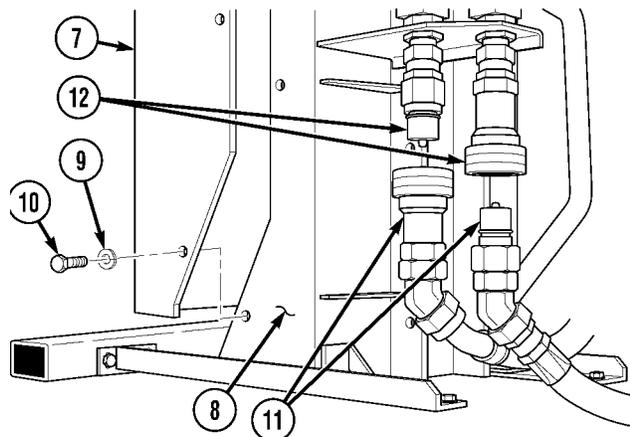

END OF TASK

Direct Support and General Support Maintenance (Cont)

5-36. LOAD HANDLING SYSTEM (LHS) HOOK ARM MANIFOLD REPAIR.

This task covers:

- | | | |
|----------------|------------------------|--------------------------|
| a. Removal | c. Cleaning/Inspection | e. Installation |
| b. Disassembly | d. Assembly | f. Follow-on Maintenance |

INITIAL SETUP

Models

M1120

Test Equipment

None

Special Tools

- Tool Kit, General Mechanic's, Item 32, Appendix B
- Cap and Plug Set, Item 2, Appendix B
- Gloves, Chemical Oil Protective, Item 11, Appendix B
- Goggles, Industrial, Item 12, Appendix B
- Pan, Drain 4 gal, Item 16, Appendix B
- Wrench, Combination, 1-1/4 in., Item 38, Appendix B
- Wooden Block (2), Appendix H
- Lifting Device, Minimum Capacity 2,500 lb. (1135 kg)

Supplies

- Oil, Hydraulic, Item 12, Appendix F
- Sealing Compound, Item 18, Appendix F
- Solvent, Drycleaning, Item 18, Appendix F
- Tags, Identification, Item 19, Appendix F
- Lockwasher (8), Item 13, Appendix K
- Lockwasher (4), Item 17, Appendix K

Supplies - Continued

- Preformed Packing Kit, Item 34, Appendix K
- Preformed Packing Kit, Item 38, Appendix K
- Preformed Packing Kit, Item 40, Appendix K

Personnel Required

MOS 63W, Wheel vehicle repairer

References

None

Equipment Condition

<i>TM or Para</i>	<i>Condition Description</i>
TM 9-2320-279-10	Engine OFF
TM 9-2320-279-10	Wheels chocked
Para 4-35	LHS manifold cover removed

Special Environmental Conditions

None

General Safety Instructions

None

Direct Support and General Support Maintenance (Cont)

5-36. LOAD HANDLING SYSTEM (LHS) HOOK ARM MANIFOLD REPAIR (CONT).

a. Removal.

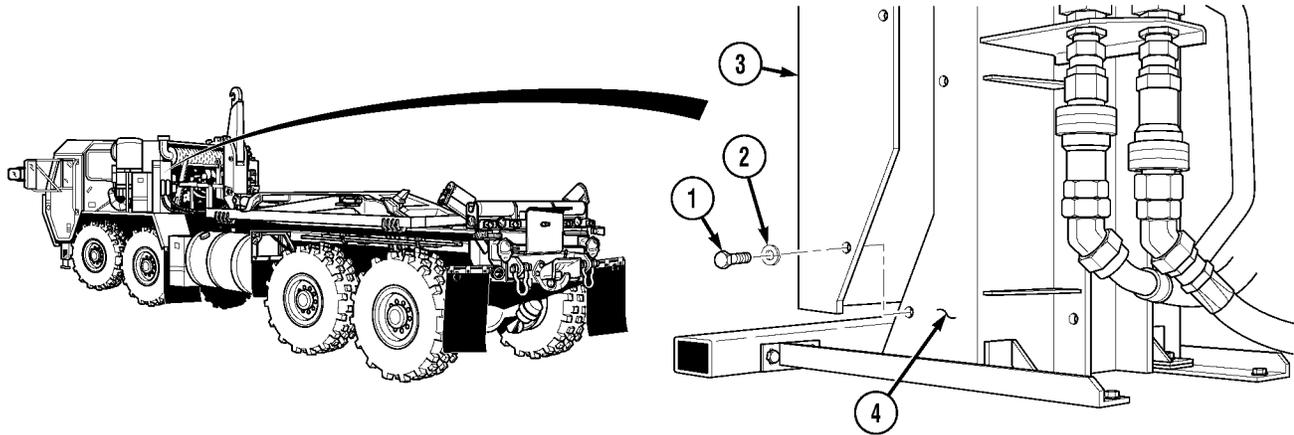

NOTE

Only remove center screw on engine side of LHS control box cover.

- (1) Remove four screws (1), lockwashers (2), and LHS control box cover (3) from bracket (4). Discard lockwashers.

Direct Support and General Support Maintenance (Cont)

STEERING WHEEL SHOWN
REMOVED FOR
CLARITY

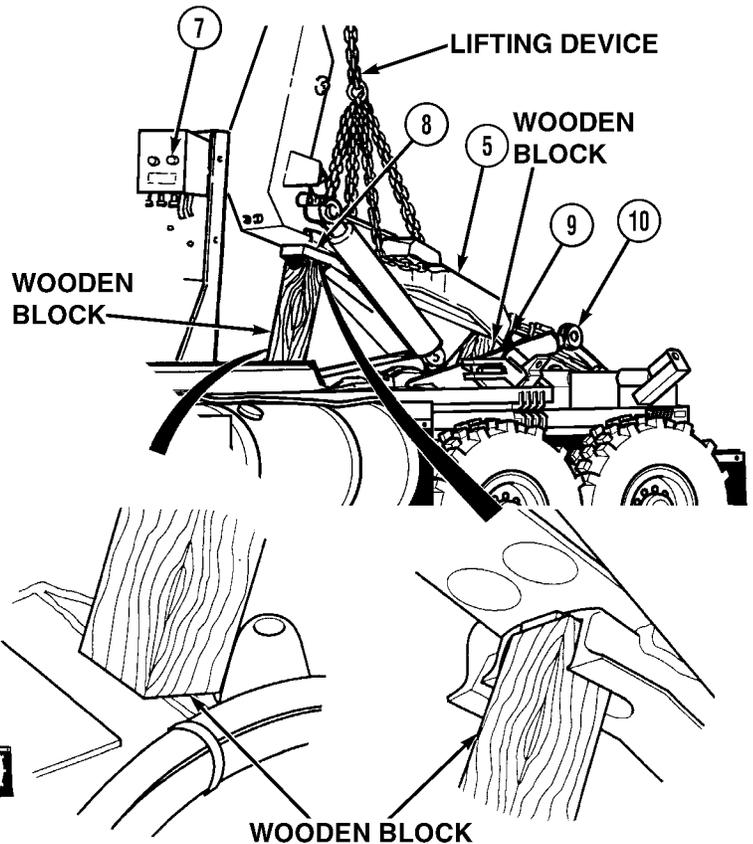
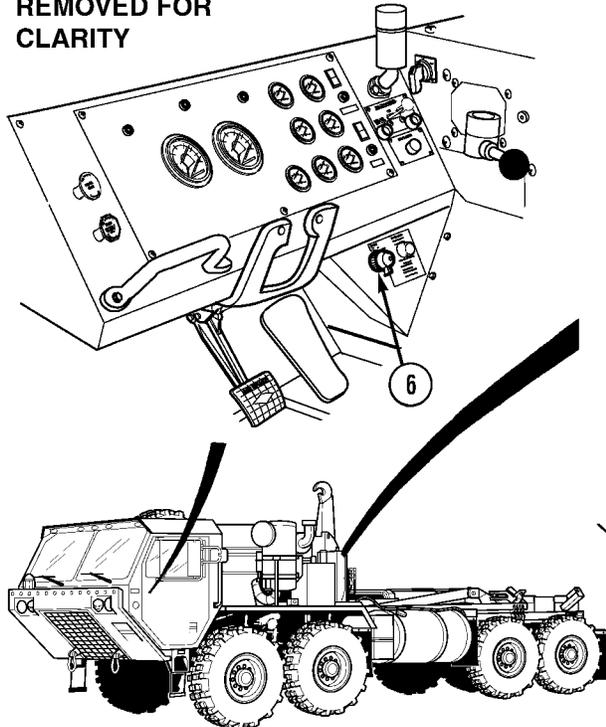

WARNING

Main frame and hook arm combined weight is 2,100 lbs. (953 kg). Attach suitable lifting device prior to removal to prevent possible injury to personnel.

NOTE

- There are two hook arm manifolds.
- Both manifolds are removed the same way. Left side shown.
- Remove cable ties as required.

- (2) Attach lifting device to hook arm (5).
- (3) Turn ENGINE switch (6) to ON position.
- (4) With the aid of another soldier, press main frame safe lowering button (7) while using lifting device to raise main frame (8) up until hook arm pivot pin (9) is above main frame cylinder (10) and block up main frame in two places.
- (5) Remove lifting device from hook arm (5).

Direct Support and General Support Maintenance (Cont)

5-36. LOAD HANDLING SYSTEM (LHS) HOOK ARM MANIFOLD REPAIR (CONT).

STEERING WHEEL SHOWN
REMOVED FOR
CLARITY

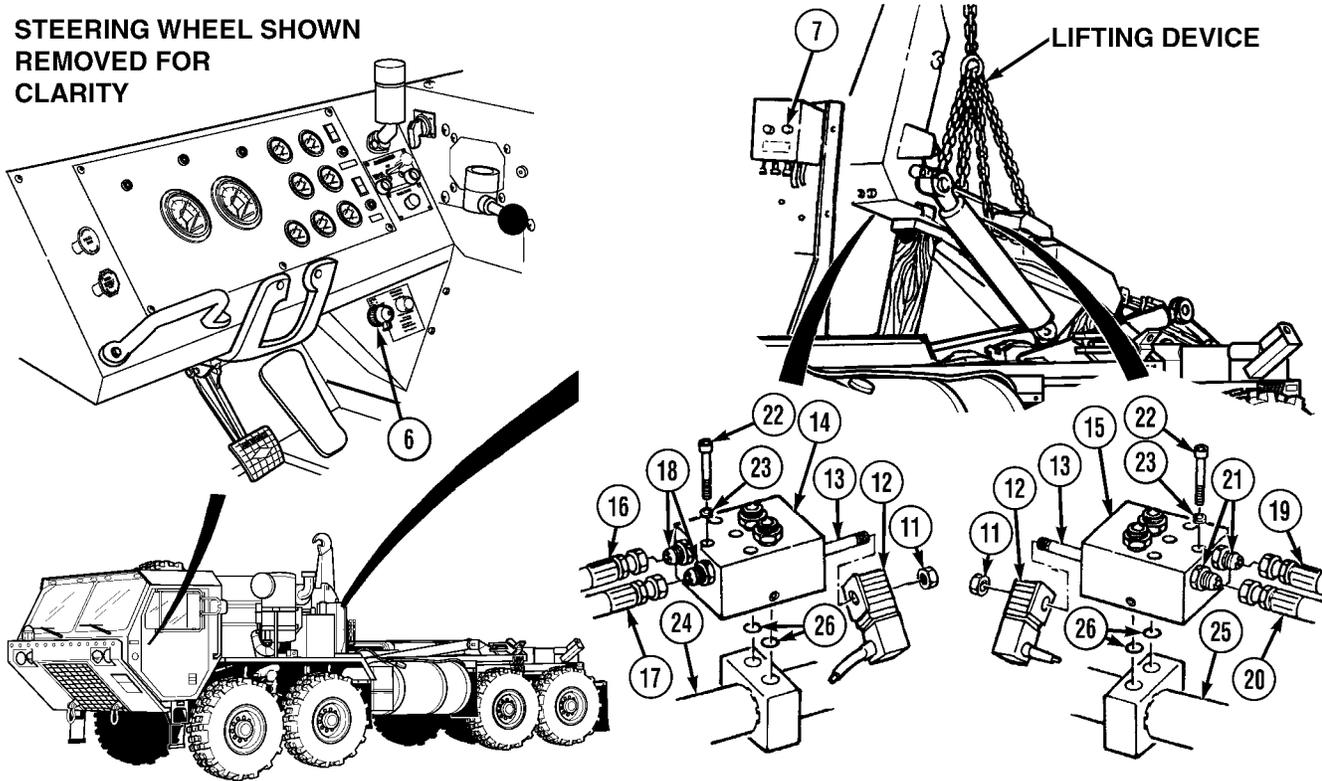

WARNING

The LHS hydraulic system operates at oil pressures up to 1,725 psi (11 894 kPa). Never disconnect any hydraulic line or fitting without first dropping pressure to zero. Failure to comply may result in serious injury or death to personnel.

- (6) Press main frame safe lowering button (7) to relieve hydraulic pressure.
- (7) Turn ENGINE switch (6) to OFF position.
- (8) Remove two nuts (11) and solenoid valve coils (12) from solenoid valves (13).
- (9) Position drain pan under left manifold (14) and right manifold (15).

NOTE

- Tag and mark hoses prior to removal.
 - Cap hydraulic hoses after disconnecting.
- (10) Remove hose 2881 (16) and hose 2891 (17) from two fittings (18) on left manifold (14).
 - (11) Remove hose 2882 (19) and hose 2892 (20) from two fittings (21) on right manifold (15).
 - (12) Remove eight screws (22), lockwashers (23), and left and right manifolds (14 and 15) from left and right cylinders (24 and 25). Discard lockwashers.
 - (13) Remove four preformed packings (26) from left and right manifolds (14 and 15). Discard preformed packings.

Direct Support and General Support Maintenance (Cont)

b. Disassembly.

NOTE

Note location and position of valves, adapters, and plugs prior to removal.

- (1) Remove two load control valves (1) from hook arm manifold (2).
- (2) Remove two backup rings (3), preformed packing (4), preformed packing (5), backup ring (6), and preformed packing (7) from each load control valve (1). Discard preformed packings and backup rings.

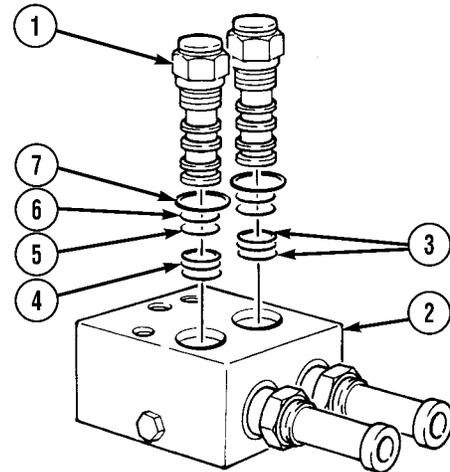

- (3) Remove two hex head plugs (8), adapters (9) and solenoid valves (10) from hook arm manifold (2).
- (4) Remove two preformed packings (11) from hex head plugs (8). Discard preformed packings.
- (5) Remove two preformed packings (12) from adapters (9). Discard preformed packings.
- (6) Remove two backup rings (13), preformed packing (14), and preformed packing (15) from each solenoid valve (10). Discard backup rings and preformed packing.

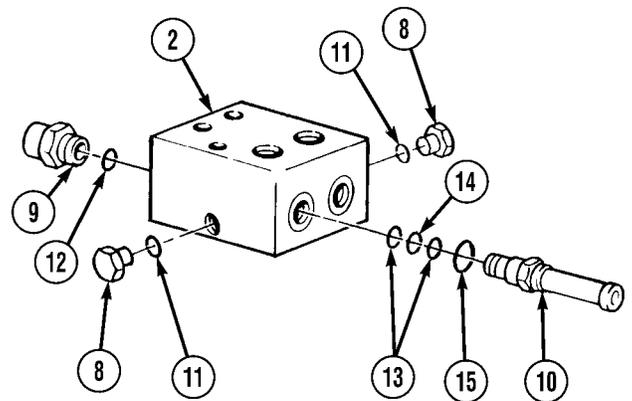

c. Cleaning/Inspection.

WARNING

- Drycleaning solvent (P-D-680) is TOXIC and flammable. Wear protective goggles, face shield, and gloves; use only in a well-ventilated area; avoid contact with skin, eyes, and clothes; and do not breathe vapors. Keep away from heat or flame. Never smoke when using solvent. The flashpoint for Type III Drycleaning Solvent is 200°F (93°C). Failure to do so may result in injury or death to personnel.
- If personnel become dizzy while using cleaning solvent, immediately get fresh air and medical help. If solvent contacts skin or clothes, flush with cold water. If solvent contacts eyes, immediately flush eyes with water and get immediate medical attention.

- (1) Clean hook arm manifold and components using drycleaning solvent.
- (2) Inspect for any foreign material in ports and remove as necessary.
- (3) Inspect for cracks, gouges, nicks, or stripped threads.
- (4) Replace all damaged parts.

Direct Support and General Support Maintenance (Cont)

5-36. LOAD HANDLING SYSTEM (LHS) HOOK ARM MANIFOLD REPAIR (CONT).

d. Assembly.

NOTE

Install plugs, adapters, and valves as noted prior to removal.

- (1) Apply hydraulic oil to two preformed packings (1) and two backup rings (3).
- (2) Install two preformed packings (2), preformed packing (1) and four backup rings (3) on two solenoid valves (4).
- (3) Apply hydraulic oil to two preformed packings (5).
- (4) Install two preformed packings (5) on hex head plugs (6).
- (5) Apply hydraulic oil to two preformed packings (7).
- (6) Install two preformed packings (7) on adapters (8).
- (7) Install two solenoid valves (4) in hook arm manifold (9).
- (8) Install two adapters (8) in hook arm manifold (9).
- (9) Install two hex head plugs (6) in hook arm manifold (9).
- (10) Apply hydraulic oil to two preformed packings (10), backup rings (11), preformed packings (12), preformed packing (13), and four backup rings (14).
- (11) Install two preformed packings (10), backup rings (11), preformed packings (12), preformed packing (13), and four backup rings (14) on two load control valves (15).
- (12) Install two load control valves (15) in hook arm manifold (9).

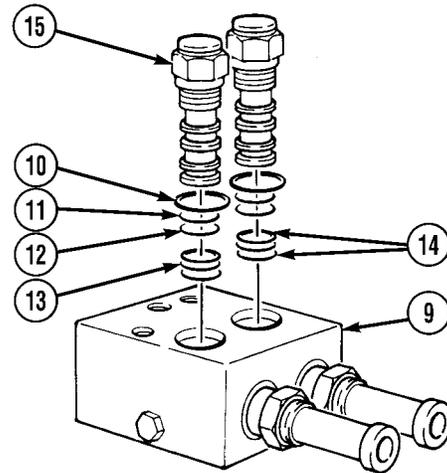
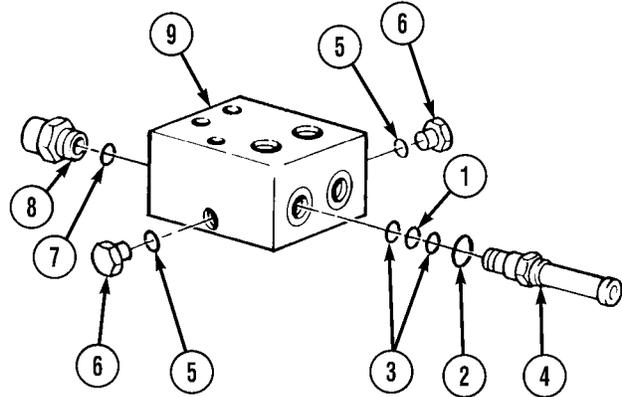

Direct Support and General Support Maintenance (Cont)

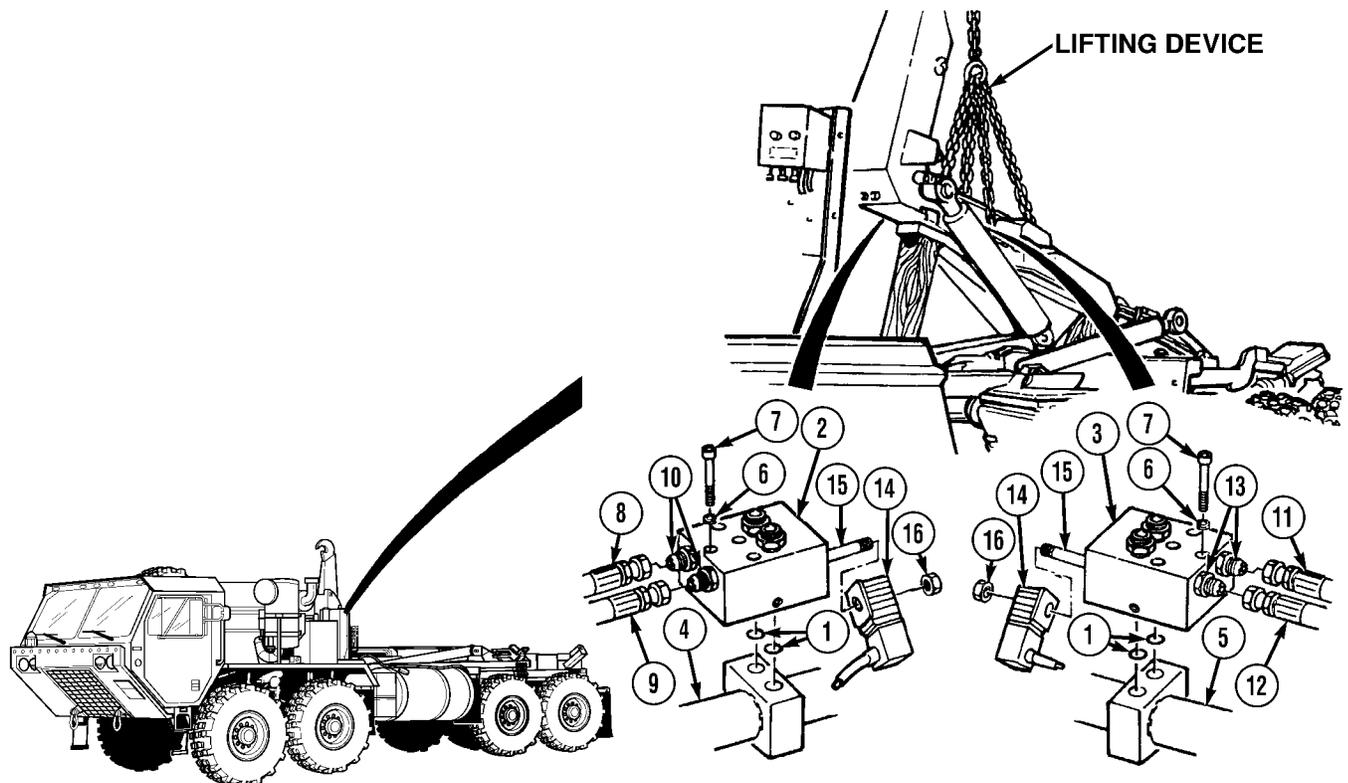
e. Installation.**NOTE**

Install cable ties as required.

- (1) Apply hydraulic oil to four preformed packings (1).
- (2) Install four preformed packings (1) on left and right hook arm manifolds (2 and 3).
- (3) Install left and right hook arm manifolds (2 and 3) on left and right cylinders (4 and 5) with eight lockwashers (6) and screws (7).

WARNING

Adhesives, solvents, and sealing compounds can burn easily, can give off harmful vapors, and are harmful to skin and clothing. To avoid injury or death, keep away from open fire and use in a well-ventilated area. If adhesive, solvent, or sealing compound gets on skin or clothing, wash immediately with soap and water.

- (4) Apply sealing compound in countersunk hole around head of eight screws (7).
- (5) Install hose 2881 (8) and hose 2891 (9) on two fittings (10) on left hook arm manifold (2).
- (6) Install hose 2882 (11) and 2892 (12) on two fittings (13) on right hook arm manifold (3).
- (7) Install two solenoid valve coils (14) on solenoid valves (15) with nuts (16).
- (8) Apply sealing compound to two nuts (16).

Direct Support and General Support Maintenance (Cont)

5-36. LOAD HANDLING SYSTEM (LHS) HOOK ARM MANIFOLD REPAIR (CONT).

STEERING WHEEL SHOWN
REMOVED FOR
CLARITY

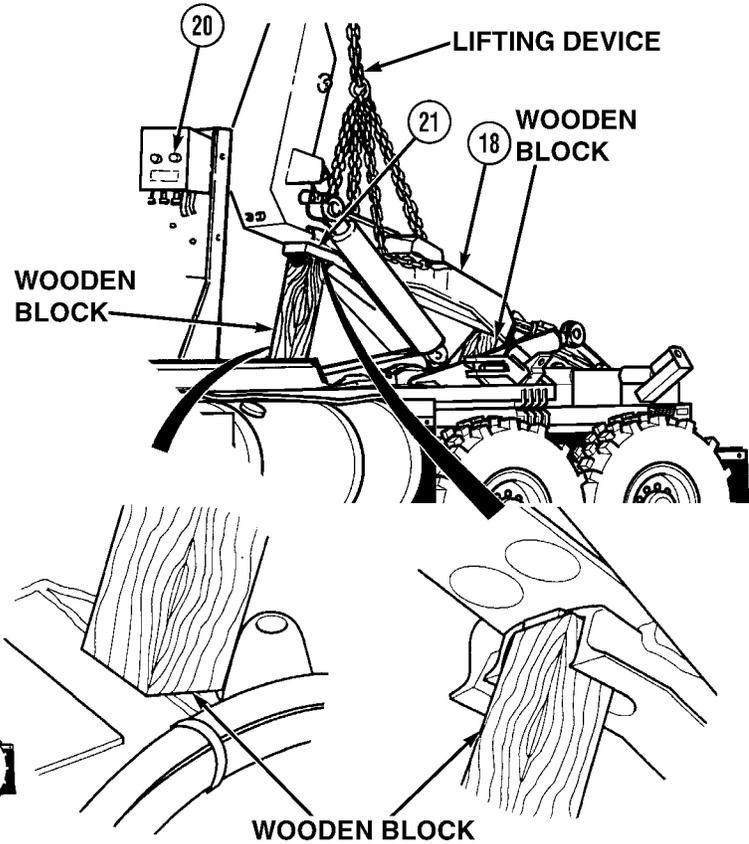
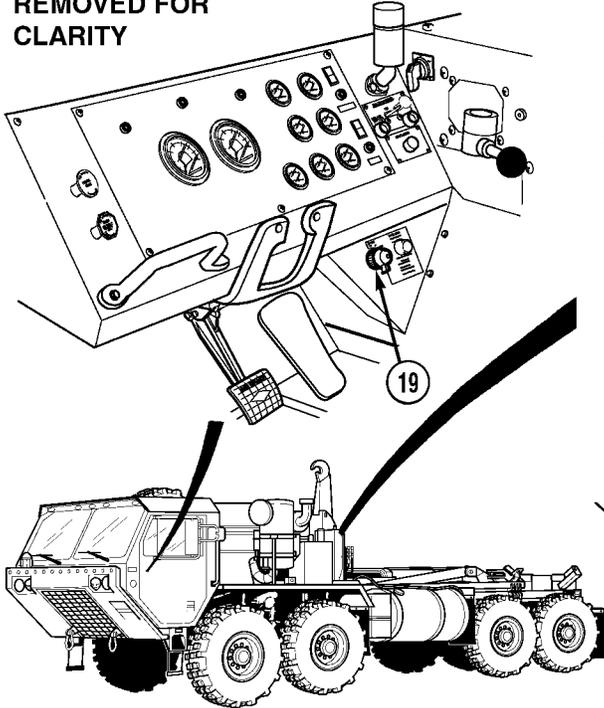

WARNING

Main frame and hook arm have a combined weight of 2,100 lbs. (953 kg). Attach suitable lifting device prior to installation to prevent possible injury to personnel.

CAUTION

Blocks supporting main frame can fall when main frame is supported with a lifting device. Have soldier prevent blocking from falling or damage to equipment may result.

- (9) Attach lifting device to hook arm (18).
- (10) Turn ENGINE switch (19) to ON position.
- (11) With the aid of another soldier, press main frame safe lowering button (20) while using lifting device to raise hook arm (18) and main frame (21), remove blocking and then lower main frame.
- (12) Turn ENGINE switch (19) to OFF position.
- (13) Remove lifting device from hook arm (18).

Direct Support and General Support Maintenance (Cont)

- (14) Install LHS control box cover (22) on bracket (23) with four lockwashers (24) and screws (25).

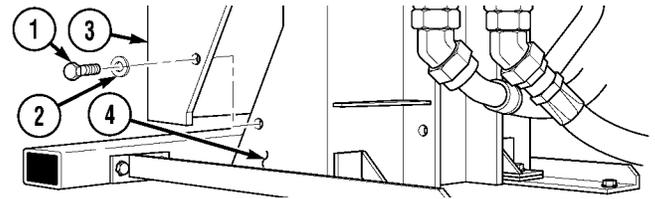

f. Follow-on Maintenance.

- (1) Install LHS manifold cover (Para 4-35).
- (2) Start engine (TM 9-2320-279-10).
- (3) Operate LHS (Para 2-9).
- (4) Check for oil leaks (TM 9-2320-279-10).
- (5) Shut OFF engine (TM 9-2320-279-10).
- (6) Check hydraulic oil reservoir level (TM 9-2320-279-20).
- (7) Remove wheel chocks (TM 9-2320-279-10).

END OF TASK

5-37. LOAD HANDLING SYSTEM (LHS) HOOK ARM CYLINDER REPLACEMENT.										
This task covers:										
a. Removal	b. Installation	c. Follow-on Maintenance								
INITIAL SETUP										
<i>Models</i> M1120	<i>Personnel Required</i> MOS 63W, Wheel vehicle repairer									
<i>Test Equipment</i> None	<i>References</i> None									
<i>Special Tools</i> Tool Kit, General Mechanic's, Item 32, Appendix B Pliers, Channel Lock, Item 17, Appendix B Wooden Blocks (2), Appendix H Lifting Device, Minimum capacity 2,100 lbs. (953 kg)	<i>Equipment Condition</i> <table border="0"> <tr> <td><i>TM or Para</i></td> <td><i>Condition Description</i></td> </tr> <tr> <td>TM 9-2320-279-10</td> <td>Engine OFF</td> </tr> <tr> <td>TM 9-2320-279-10</td> <td>Wheels chocked</td> </tr> <tr> <td>Para 5-36</td> <td>Hook arm manifold removed</td> </tr> </table>		<i>TM or Para</i>	<i>Condition Description</i>	TM 9-2320-279-10	Engine OFF	TM 9-2320-279-10	Wheels chocked	Para 5-36	Hook arm manifold removed
<i>TM or Para</i>	<i>Condition Description</i>									
TM 9-2320-279-10	Engine OFF									
TM 9-2320-279-10	Wheels chocked									
Para 5-36	Hook arm manifold removed									
<i>Supplies</i> Oil, Hydraulic, Item 12, Appendix F Sealing Compound, Item 16, Appendix F Locknut, Item 5, Appendix K Locknut (2), Item 10, Appendix K Lockwasher (2), Item 15, Appendix K Lockwasher (2), Item 24, Appendix K	<i>Special Environmental Conditions</i> None									
	<i>General Safety Instructions</i> None									

Direct Support and General Support Maintenance (Cont)

5-37. LOAD HANDLING SYSTEM (LHS) HOOK ARM CYLINDER REPLACEMENT (CONT).

a. Removal.

WARNING

- Hook arm cylinders weighs 210 lbs. (95 kg). Attach suitable lifting device prior to removal to prevent possible injury to personnel.
- Ensure hook arm assembly is supported with wooden blocks prior to removal to prevent possible injury to personnel.

- (1) Attach lifting device to right side cylinder (1).
- (2) Remove two locknuts (2) and lockwashers (3) from right side cylinder (1) by bending lockwasher (3) tabs out of locknut (2) slots. Discard locknuts and lockwashers.
- (3) Using lifting device, remove right side cylinder (1) form hook arm (4) and main frame (5).
- (4) Remove lifting device from right side cylinder (1).

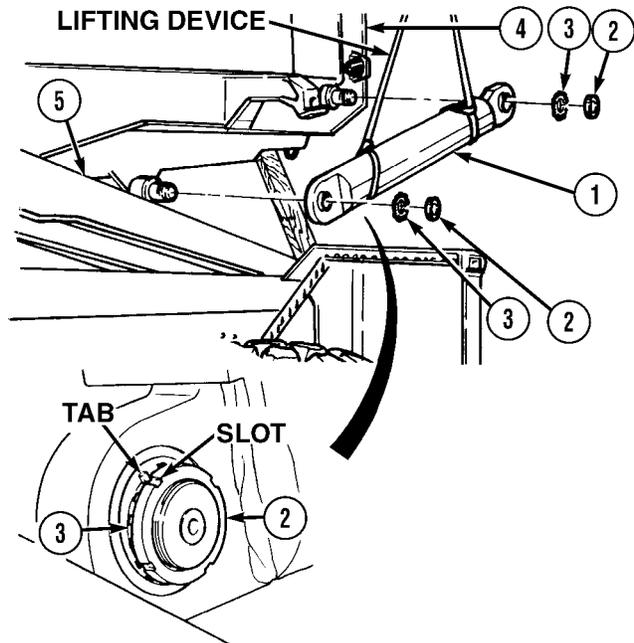
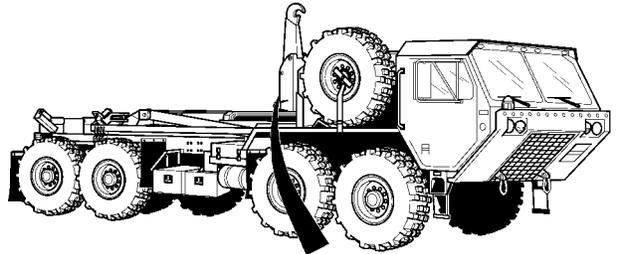

Direct Support and General Support Maintenance (Cont)

WARNING

Hook arm cylinder weighs 210 lbs. (95 kg). Attach suitable lifting device prior to removal to prevent possible injury to personnel.

- (5) Attach lifting device to left side cylinder (6).
- (6) Remove two screws (7), lockwashers (8), washers (9), cylinder shafts (10), and left side cylinder (6) from hook arm (4) and main frame (5). Discard lockwashers.
- (7) Remove lifting device from left side cylinder (6).

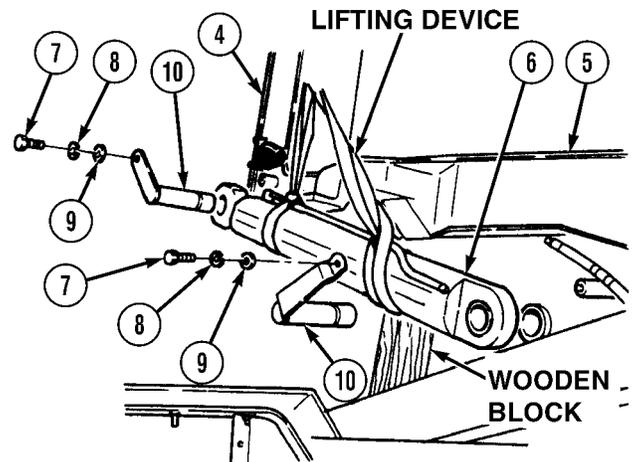
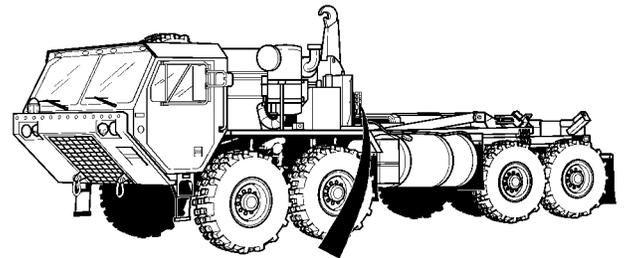

b. Installation.

WARNING

Hook arm cylinder weighs 210 lbs. (95 kg). Attach suitable lifting device prior to installation to prevent possible injury to personnel.

- (1) Attach lifting device to left side cylinder (1).
- (2) Install barrel end (rear) of left side cylinder (1) with cylinder shaft (2) to main frame (3).
- (3) Install washer (4), lockwasher (5), and screw (6) on cylinder shaft (2).
- (4) Lower left side cylinder (1) and remove lifting device.

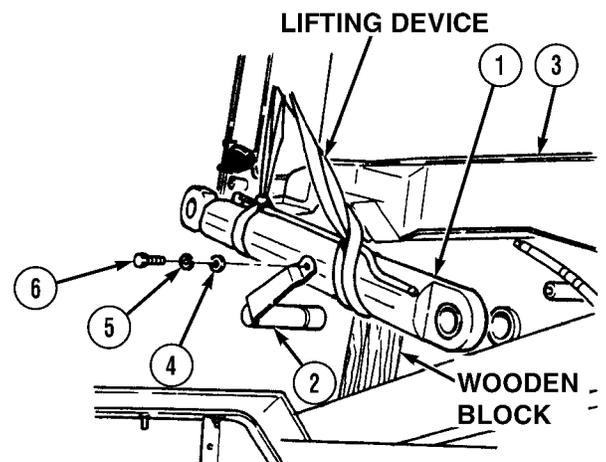
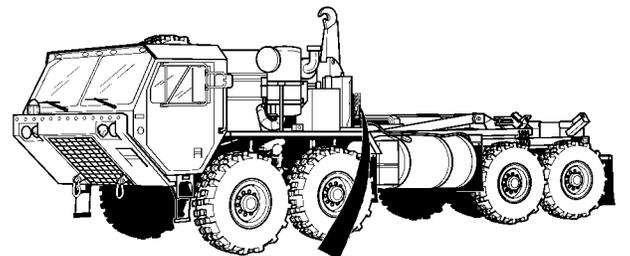

Direct Support and General Support Maintenance (Cont)

5-37. LOAD HANDLING SYSTEM (LHS) HOOK ARM CYLINDER REPLACEMENT (CONT).

WARNING

Hook arm cylinder weighs 210 lbs. (95 kg). Attach suitable lifting device prior to installation to prevent possible injury to personnel.

- (5) Attach lifting device to right side cylinder (7).
- (6) Using lifting device, install barrel end (rear) of right side cylinder (7) on cylinder shaft (2) on main frame (3).
- (7) Install lockwasher (8) and locknut (9) on cylinder shaft (2). Bend lockwasher (8) tab into locknut (9) slot.
- (8) Lower right side cylinder (7) and remove lifting device.

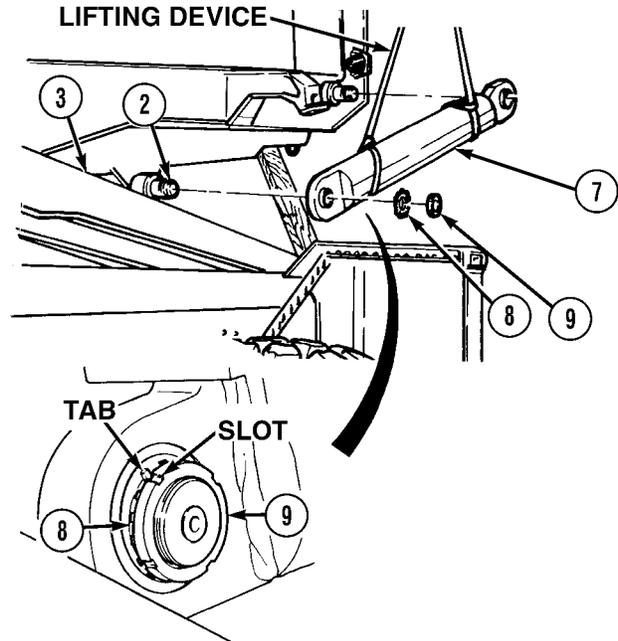

- (9) Remove two rubber bumpers (10) and locknuts (11) from compression frame (12). Discard locknuts.

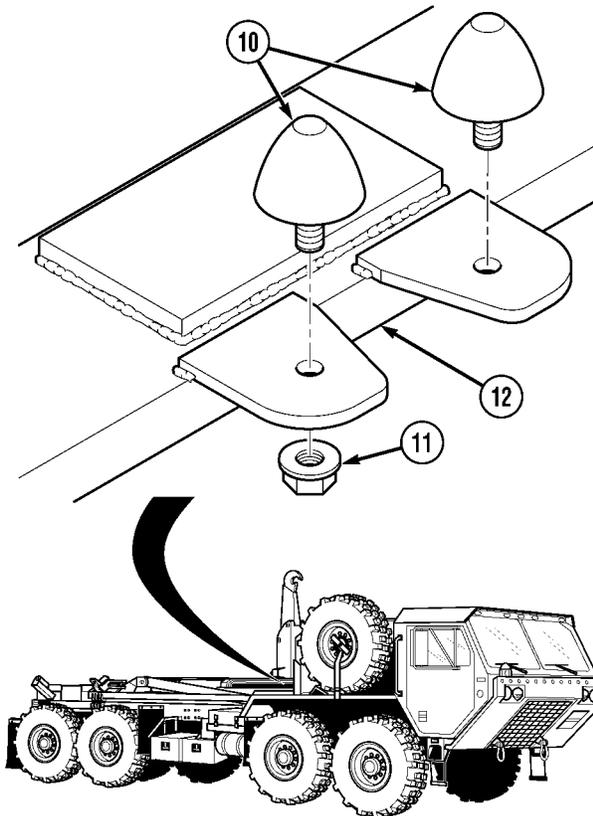

Direct Support and General Support Maintenance (Cont)

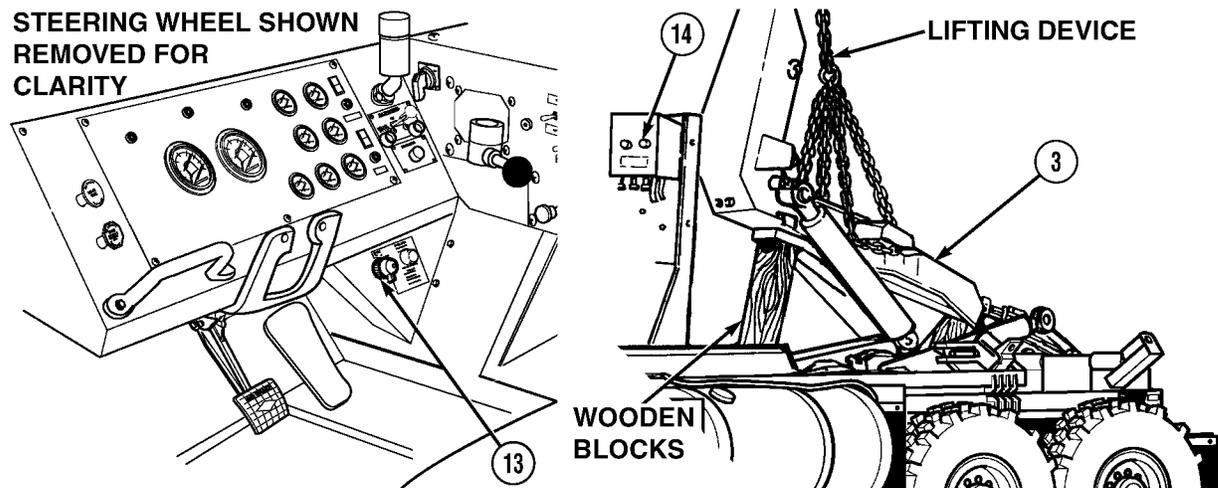
**WARNING**

Main frame and hook arm combined weight is 2,100 lbs. (953 kg). Attach suitable lifting device prior to removal to prevent possible injury to personnel.

CAUTION

Blocks supporting main frame can fall when main frame is supported with a lifting device. Have soldier prevent wooden blocking from falling or damage to equipment may result.

- (10) Attach lifting device to hook arm (3).
- (11) Soldier A turn ENGINE switch (13) to ON position and Soldier B press main frame safe lowering button (14) while using lifting device to raise main frame (3), remove wooden blocking and lower main frame (3).
- (12) Turn ENGINE switch (13) to OFF position. With the aid of another soldier remove lifting device from main frame (3).

Direct Support and General Support Maintenance (Cont)

5-37. LOAD HANDLING SYSTEM (LHS) HOOK ARM CYLINDER REPLACEMENT (CONT).

WARNING

Hook arm cylinder weighs 210 lbs. (95 kg). Attach suitable lifting device prior to lifting to prevent possible injury to personnel.

NOTE

Steps (13) through (16) are for cylinder adjustment. Adjustment must be completed before completing installation of cylinders. Left side shown.

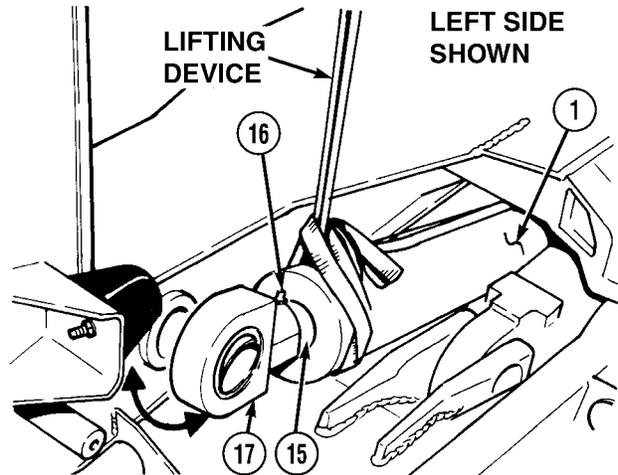

- (13) Attach lifting device to left side cylinder (1).
- (14) Adjust cylinders by supporting left side cylinder (1) using lifting device and fully retract cylinder rod (15) in cylinder (1).
- (15) Pull cylinder rod (15) out 1.4 in. (36 mm).
- (16) Loosen hex head screw (16) and rotate rod lug (17) so rod lug bore lines up with cylinder shaft bore in hook arm (18). Tighten hex head screw (16).

NOTE

Do step (17) for left side cylinder only.

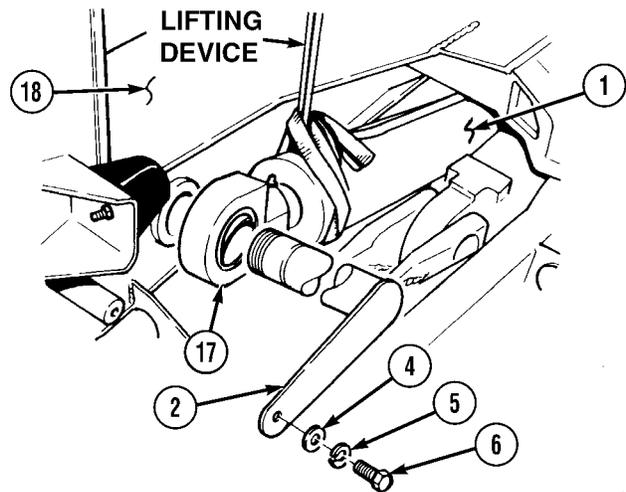

- (17) Install left side cylinder (1) (rod lug end) with cylinder shaft (2), washer (4), lockwasher (5), and screw (6) on hook arm (18) when rod lug (17) bore and bore in hook arm line up.
- (18) Remove lifting device from left side cylinder (1).

Direct Support and General Support Maintenance (Cont)

WARNING

Hook arm cylinder weighs 210 lbs. (95 kg). Attach suitable lifting device prior to lifting to prevent possible injury to personnel.

- (19) Attach lifting device on right side cylinder (7).
- (20) Using lifting device, install right side cylinder (7) (rod lug end) with lockwasher (8) and locknut (9) on cylinder shaft (2).
- (21) Bend lockwasher (8) tab into locknut (9).
- (22) Remove lifting device from right side cylinder (7).

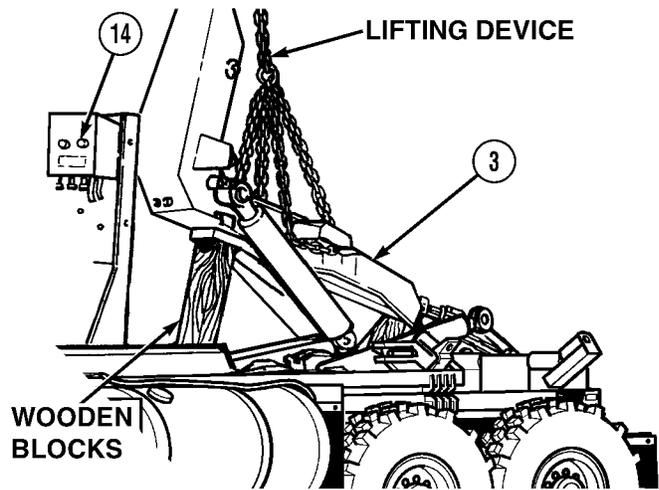
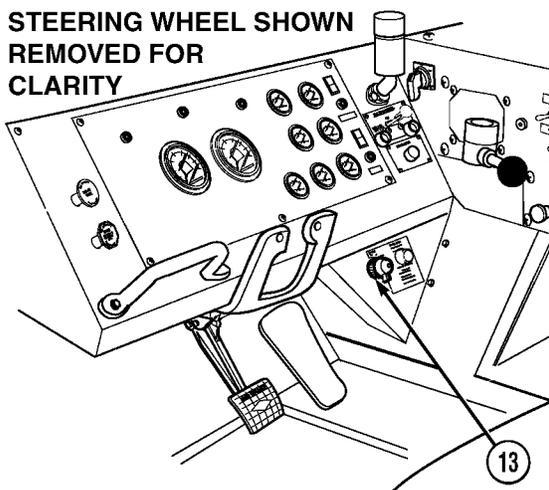
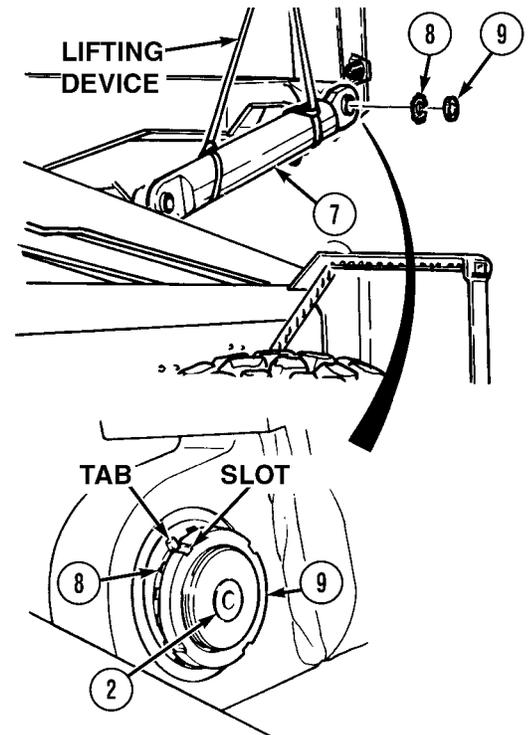

WARNING

Main frame, hook arm, and hook have a combined weight of 2,300 lbs. (1 043 kg). Attach suitable lifting device prior to lifting to prevent possible injury to personnel.

- (23) Attach lifting device to main frame (3).
- (24) Soldier A turn ENGINE switch (13) to ON position and Soldier B press main frame safe lowering button (14), while using lifting device to raise main frame (3), and block up main frame in two places.
- (25) Turn ENGINE switch (13) to OFF position and remove lifting device from main frame (3).

Direct Support and General Support Maintenance (Cont)

5-37. LOAD HANDLING SYSTEM (LHS) HOOK ARM CYLINDER REPLACEMENT (CONT).

WARNING

Adhesives, solvents, and sealing compounds can burn easily, can give off harmful vapors, and are harmful to skin and clothing. To avoid injury or death, keep away from open fire and use in a well-ventilated area. If adhesive, solvent or sealing compound gets on skin or clothing, wash immediately with soap and water.

- (26) Coat threads of two rubber bumpers (10) with sealing compound.
- (27) Install two rubber bumpers (10) on compression frame (12) with locknut (11).

c. Follow-on Maintenance.

- (1) Install hook arm manifold (Para 5-36).
- (2) Check hydraulic reservoir oil level (TM 9-2320-279-10).
- (3) Remove wheel chocks (TM 9-2320-279-10).

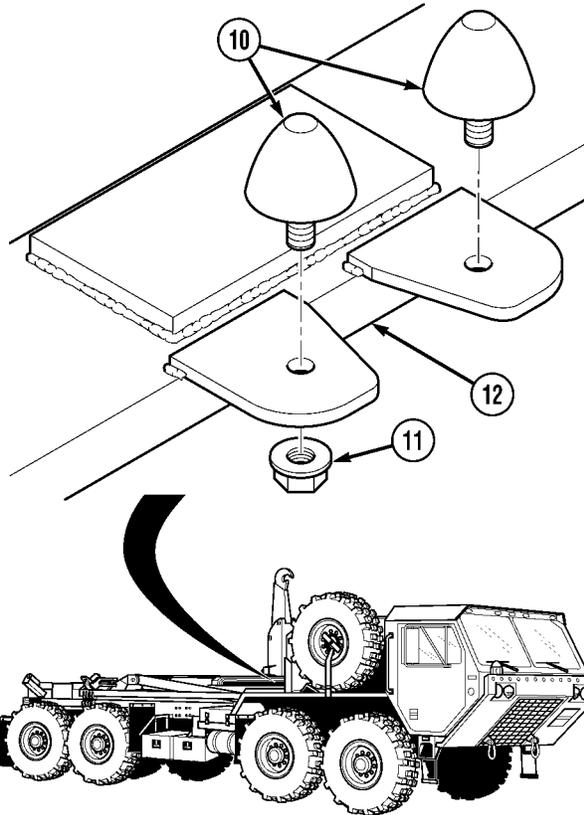

END OF TASK

Direct Support and General Support Maintenance (Cont)

5-38. LOAD HANDLING SYSTEM (LHS) HOOK ARM/MAIN FRAME CYLINDER REPAIR.	
This task covers:	
a. Disassembly	c. Assembly
b. Cleaning/Inspection	d. Follow-on Maintenance
INITIAL SETUP	
<i>Models</i> M1120	<i>Supplies</i> Cloth, Cleaning, Item 5, Appendix F Oil, Hydraulic, Item 12, Appendix F Solvent, Drycleaning, Item 18, Appendix F Plug, Nylon, Item 33, Appendix K Screw, Item 42, Appendix K Seal Kit, Item 45, Appendix K
<i>Test Equipment</i> None	<i>Personnel Required</i> MOS 63W, Wheel vehicle repairer
<i>Special Tools</i> Tool Kit, General Mechanic's, Item 32, Appendix B Drill Set, Twist, Item 5, Appendix B Drill, Electric, Portable, 1/4 in., Item 6, Appendix B Gloves, Chemical Oil Protective, Item 11, Appendix B Goggles, Industrial, Item 12, Appendix B Pan, Drain 4 gal, Item 16, Appendix B Stone, Sharpening, Item 24, Appendix B Vise, Pipe, Chain, Item 35, Appendix B Wrench Set, Socket 3/4 in. Drive, Item 45, Appendix B Wrench, Torque, (0-175 lb-ft. [0-237 N•m]) Item 48, Appendix B Lifting Device, Minimum Capacity 250 lbs. (114 kg) Wooden Blocks (2), Appendix H	<i>References</i> None
	<i>Equipment Condition</i>
	<i>TM or Para</i> <i>Condition Description</i>
	Para 5-37 Hook arm cylinder removed
	Para 5-40 Main frame cylinder removed
	<i>Special Environmental Conditions</i> None
	<i>General Safety Instructions</i> None

a. Disassembly.

WARNING

Cylinder weighs in excess of 210 lbs. (95 kg). Attach suitable lifting device prior to lifting to prevent possible injury to personnel.

- (1) Attach lifting device to cylinder (1).

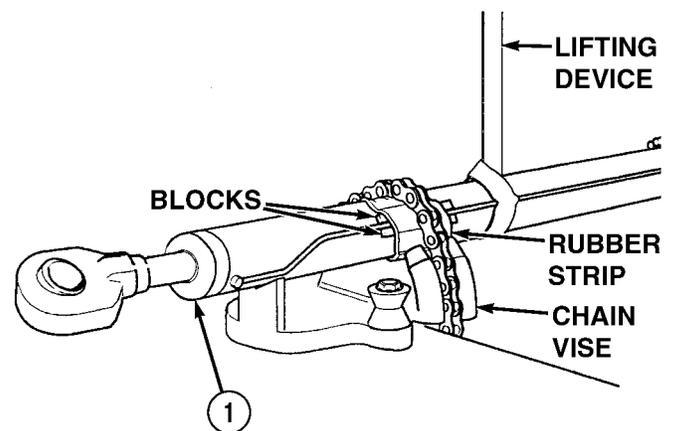

Direct Support and General Support Maintenance (Cont)

5-38. LOAD HANDLING SYSTEM (LHS) HOOK ARM/MAIN FRAME CYLINDER REPAIR (CONT).

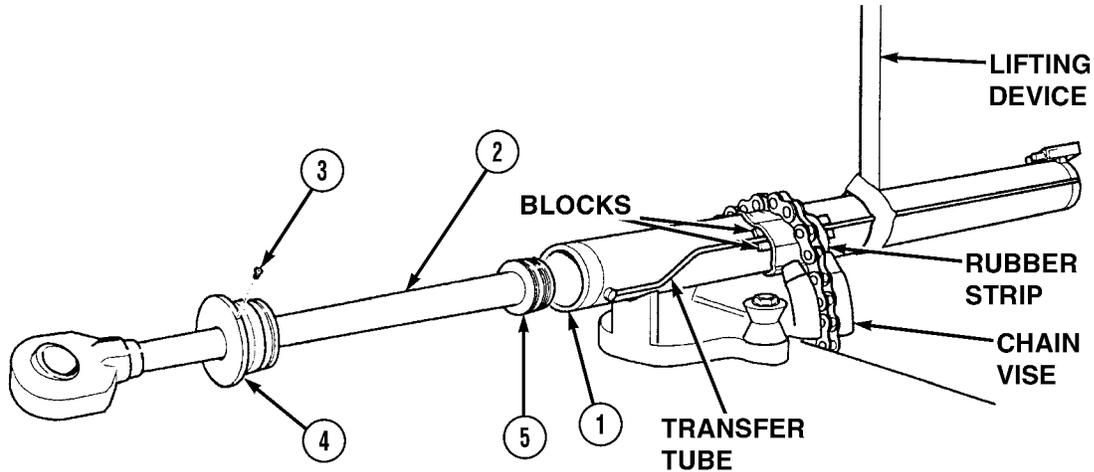

CAUTION

Transfer tube is mounted along axis of cylinder. Use blocks to protect transfer tube when clamping cylinder in a chain vise or damage to equipment may result.

- (2) Using lifting device, place cylinder (1) in chain vise using rubber stripping to protect cylinder surface. Use wooden block to protect transfer tube.

WARNING

Oil will spray from cylinder manifold ports when rod is moved in or out. Cover ports with two cleaning cloths to prevent oil from spraying. Failure to comply may result in injury to personnel.

CAUTION

Do not allow threaded or machined surfaces to come in contact with other metal surfaces. Clearances between cylinder components are very small; any minor damage done during disassembly could require component replacement or make assembly difficult.

- (3) Position drain pan under cylinder (1).
- (4) Move rod (2) out of cylinder (1) approximately 24 in. (61 cm) and properly support rod (2).
- (5) Remove screw (3) and unscrew rod bearing (4) from cylinder (1). Discard screw.
- (6) Remove rod (2) and piston (5) from cylinder (1).

Direct Support and General Support Maintenance (Cont)

WARNING

Cylinder weighs in excess of 210 lbs. (95 kg). Attach suitable lifting device prior to removal to prevent possible injury to personnel.

- (7) Using lifting device, remove cylinder (1) from chain vise.
- (8) Remove lifting device from cylinder (1).
- (9) Remove screw (6), rod lug (7), and rod bearing (4) from rod (2).

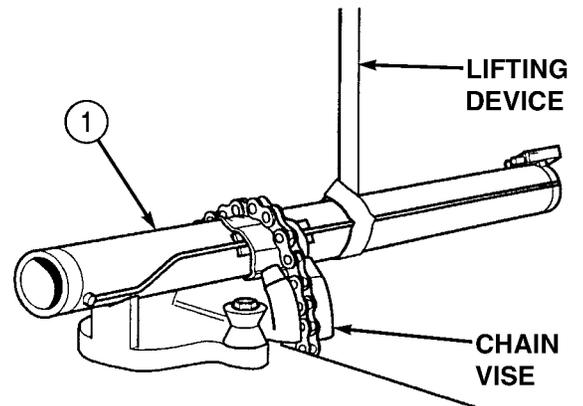

- (10) Remove nylon plug (8) from bottom of screw hole in rod lug (7). Discard nylon plug.
- (11) Remove lube fitting (9) from rod lug (7).

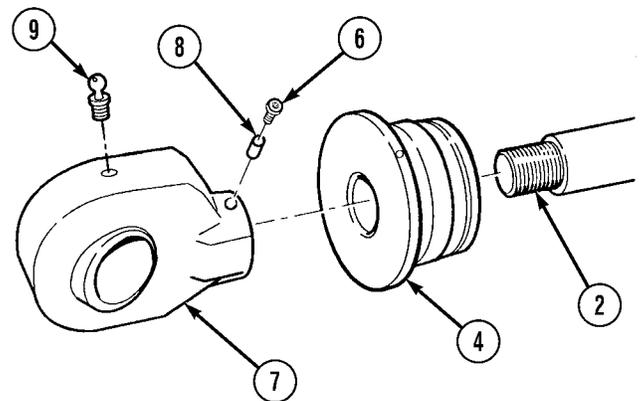

NOTE

In steps (12) and (13) note location and position of rings, seals, and packings prior to removal.

- (12) Remove two wear rings (10) and piston seal assembly (11) from piston (5). Discard wear rings and seal assembly.

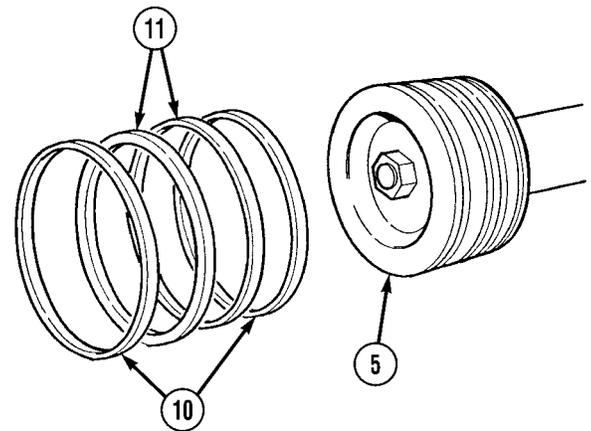

Direct Support and General Support Maintenance (Cont)

5-38. LOAD HANDLING SYSTEM (LHS) HOOK ARM/MAIN FRAME CYLINDER REPAIR (CONT).

- (13) Remove and discard wiper (12), rod seal (13), step seal assembly (14), two wear rings (15), preformed packing (16), and backup ring (17) from rod bearing (4).

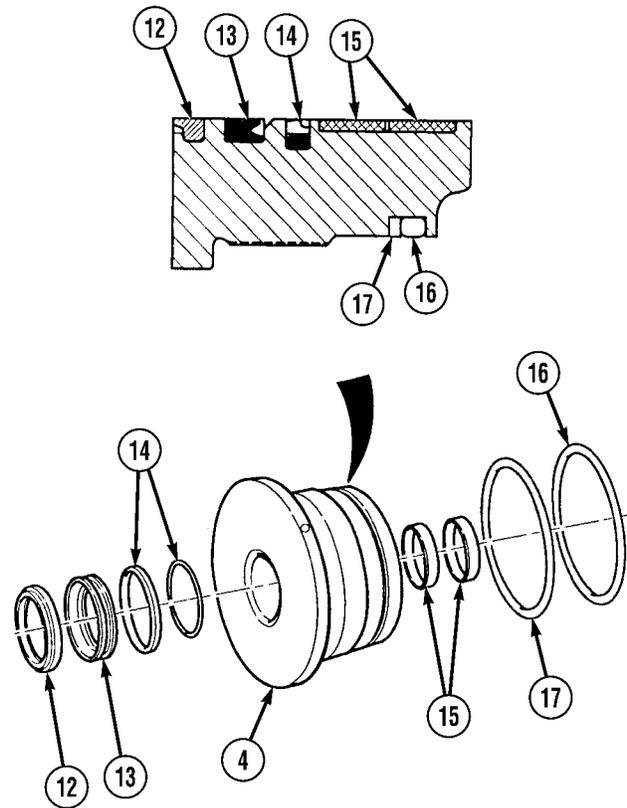

- (14) Remove lube fitting (18) from cylinder (1).

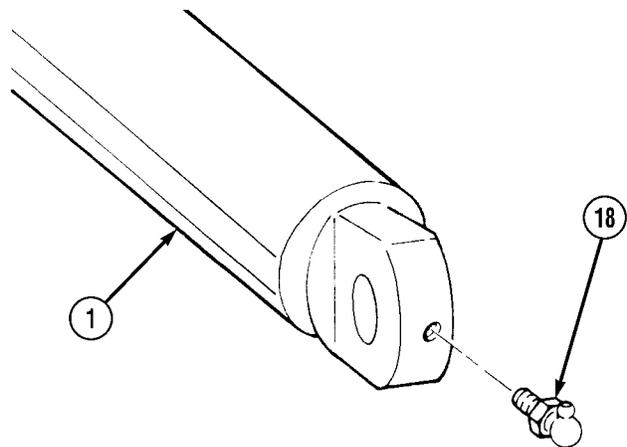

Direct Support and General Support Maintenance (Cont)

b. Cleaning/Inspection.

WARNING

- Drycleaning solvent (P-D-680) is TOXIC and flammable. Wear protective goggles, face shield, and gloves; use only in a well-ventilated area; avoid contact with skin, eyes, and clothes; and do not breathe vapors. Keep away from heat or flame. Never smoke when using solvent. The flashpoint for Type III Drycleaning Solvent is 200°F (93°C). Failure to do so may result in injury or death to personnel.
 - If personnel become dizzy while using cleaning solvent, immediately get fresh air and medical help. If solvent contacts skin or clothes, flush with cold water. If solvent contacts eyes, immediately flush eyes with water and get immediate medical attention.
- (1) Clean all components and flush cylinder barrel using drycleaning solvent (P-D-680) only. Do not use cleaning cloth as any foreign material would contaminate hydraulic system.
 - (2) Inspect barrel bore for any scratches or corrosion. Replace barrel if rusted. Replace barrel and piston if either component is scratched.
 - (3) Inspect rod for bending. Replace if necessary.
 - (4) Inspect rod for scratches or pitting. Remove minor scratches and pitting by using stone and lubrication oil. Stone imperfection just enough to smooth raised part.
 - (5) Inspect component threads for burrs and stripped threads. Replace or repair as necessary.

c. Assembly.

- (1) Apply hydraulic oil to backup ring (1), preformed packing (2), two wear rings (3), step seal assembly (4), rod seal (5), and wiper (6).
- (2) Install backup ring (1), preformed packing (2), two wear rings (3), step seal assembly (preformed packing first, then step seal) (4), rod seal (5), and wiper (6) on rod bearing (7).

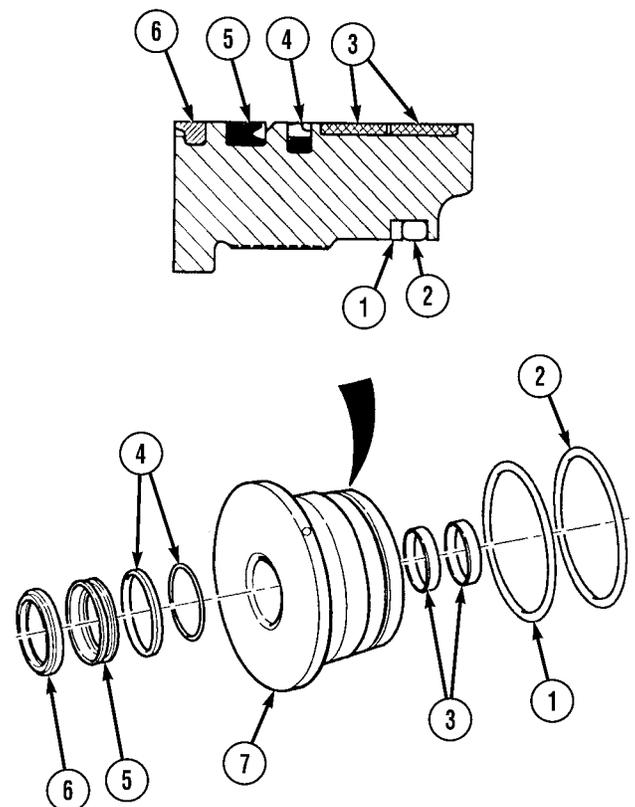

Direct Support and General Support Maintenance (Cont)

5-38. LOAD HANDLING SYSTEM (LHS) HOOK ARM/MAIN FRAME CYLINDER REPAIR (CONT).

- (3) Install lube fitting (8) to cylinder (9).

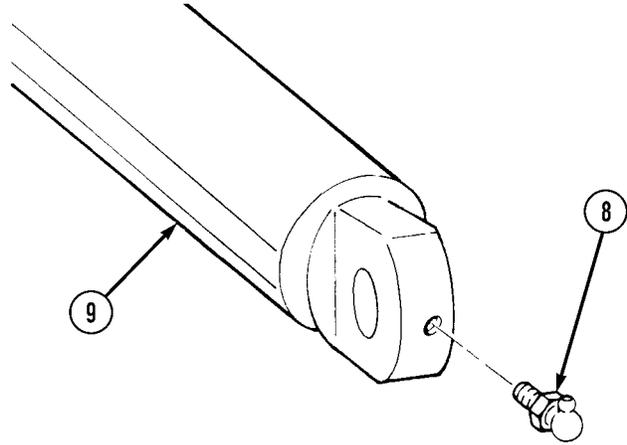

- (4) Apply hydraulic oil to piston seal assembly (10) and two wear rings (11).
- (5) Install piston seal assembly (10) and two wear rings (11) on piston (12).

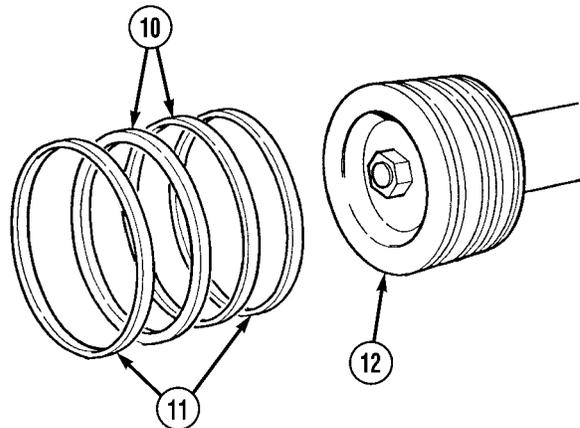

- (6) Apply hydraulic oil to inside diameter of rod bearing (7).
- (7) Install rod bearing (7) on rod (13).
- (8) Install rod lug (14) on rod (13).
- (9) Position nylon plug (15) and screw (16) in rod lug (14).
- (10) Tighten to 41 lb-ft. (56 N•m).
- (11) Install lube fitting (17) to rod lug (14).

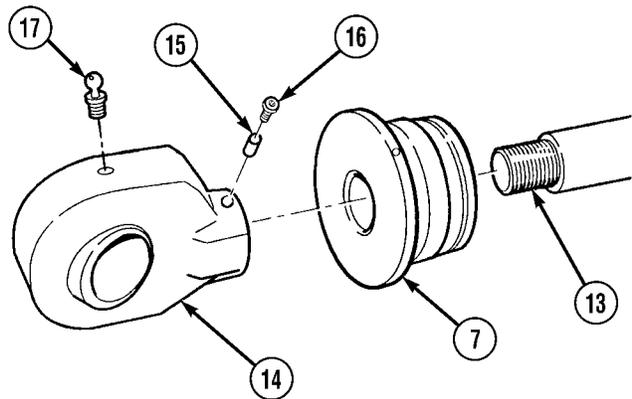

Direct Support and General Support Maintenance (Cont)

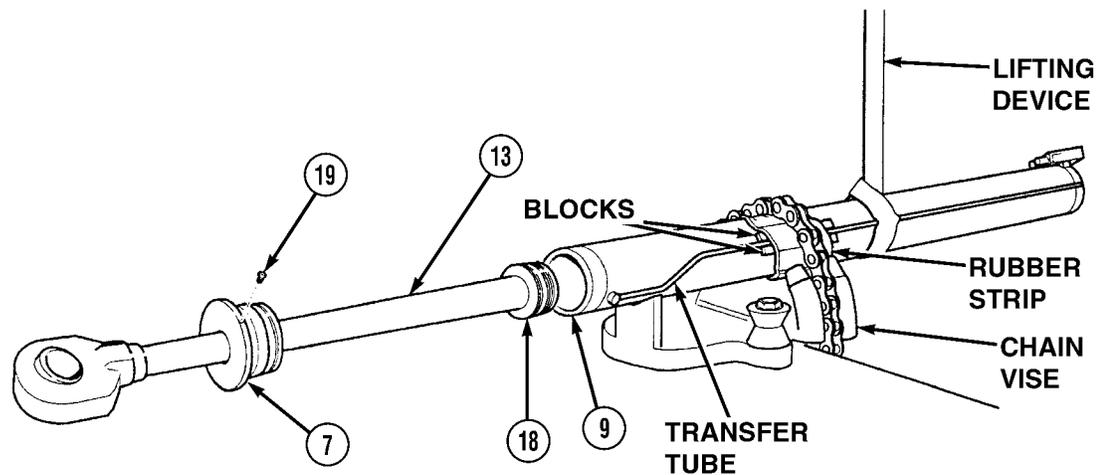
**WARNING**

Cylinder weighs in excess of 210 lbs. (95 kg). Attach suitable lifting device prior to installation to prevent possible injury to personnel.

- (12) Attach lifting device to cylinder (9).

CAUTION

Transfer tube is mounted along axis of cylinder. Use blocks to protect transfer tube when clamping cylinder in a chain vise, or damage to equipment may result.

- (13) Using lifting device, place cylinder (9) in chain vise using rubber stripping to protect cylinder surface. Use wooden block to protect transfer tube.
- (14) Install piston (18) with rod (13) and rod bearing (7) in cylinder (9).
- (15) Install rod bearing (7) in cylinder (9) and align bearing to cylinder screw hole halves. If rod bearing was replaced, drill new screw hole 0.440 in. (11.2 mm) deep using no. 26 drill (0.147 in. [3.73 mm]).
- (16) Install screw (19) in rod bearing (7).
- (17) Using lifting device, remove cylinder (9) from chain vise.

d. Follow-on Maintenance.

- (1) Install hook arm cylinder (Para 5-37).
- (2) Install main frame cylinder (Para 5-40).

END OF TASK

Direct Support and General Support Maintenance (Cont)

<p>5-39. LOAD HANDLING SYSTEM (LHS) MAIN FRAME CYLINDER MANIFOLD REPAIR.</p>							
<p>This task covers:</p>							
<p>a. Removal</p>	<p>c. Cleaning/Inspection</p>						
<p>b. Disassembly</p>	<p>d. Assembly</p>						
	<p>e. Installation</p>						
	<p>f. Follow-on Maintenance</p>						
<p>INITIAL SETUP</p>							
<p><i>Models</i> M1120</p>	<p><i>Supplies - Continued</i> Preformed Packing Kit, Item 35, Appendix K</p>						
<p><i>Test Equipment</i> None</p>	<p>Preformed Packing Kit, Item 37, Appendix K</p>						
<p><i>Special Tools</i> Tool Kit, General Mechanic's, Item 32, Appendix B Cap and Plug Set, Item 2, Appendix B Gloves, Chemical Oil Protective, Item 11, Appendix B Goggles, Industrial, Item 12, Appendix B Pan, Drain 4 gal, Item 16, Appendix B Wooden Blocks (2), Appendix H Lifting Device, Minimum Capacity 2,500 lbs. (1135 kg)</p>	<p><i>Personnel Required</i> MOS 63W, Wheel vehicle repairer (2)</p>						
	<p><i>References</i> None</p>						
	<p><i>Equipment Condition</i></p> <table border="0"> <tr> <td><i>TM or Para</i></td> <td><i>Condition Description</i></td> </tr> <tr> <td>TM 9-2320-279-10</td> <td>Engine OFF</td> </tr> <tr> <td>TM 9-2320-279-10</td> <td>Wheels chocked</td> </tr> </table>	<i>TM or Para</i>	<i>Condition Description</i>	TM 9-2320-279-10	Engine OFF	TM 9-2320-279-10	Wheels chocked
<i>TM or Para</i>	<i>Condition Description</i>						
TM 9-2320-279-10	Engine OFF						
TM 9-2320-279-10	Wheels chocked						
	<p><i>Special Environmental Conditions</i> None</p>						
<p><i>Supplies</i> Oil, Hydraulic, Item 12, Appendix F Sealing Compound, Item 18, Appendix F Tags, Identification, Item 19, Appendix F Lockwasher (4), Item 13, Appendix K Packing, Preformed (3), Item 28, Appendix K</p>	<p><i>General Safety Instructions</i> None</p>						

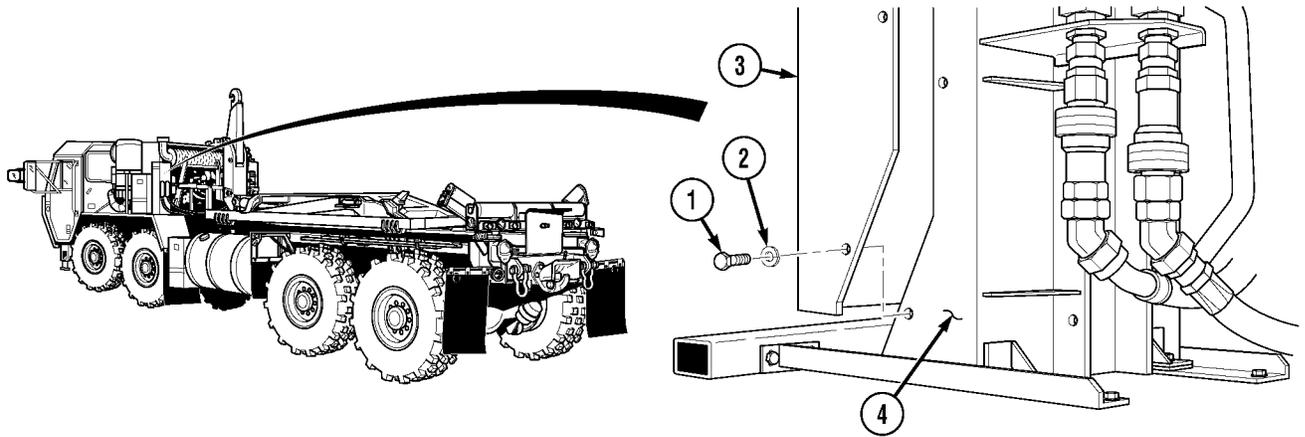
Direct Support and General Support Maintenance (Cont)**a. Removal.****NOTE**

Only remove center screw on engine side of LHS control box cover.

- (1) Remove four screws (1), lockwashers (2), and LHS control box cover (3) from bracket (4). Discard lockwashers.

Direct Support and General Support Maintenance (Cont)

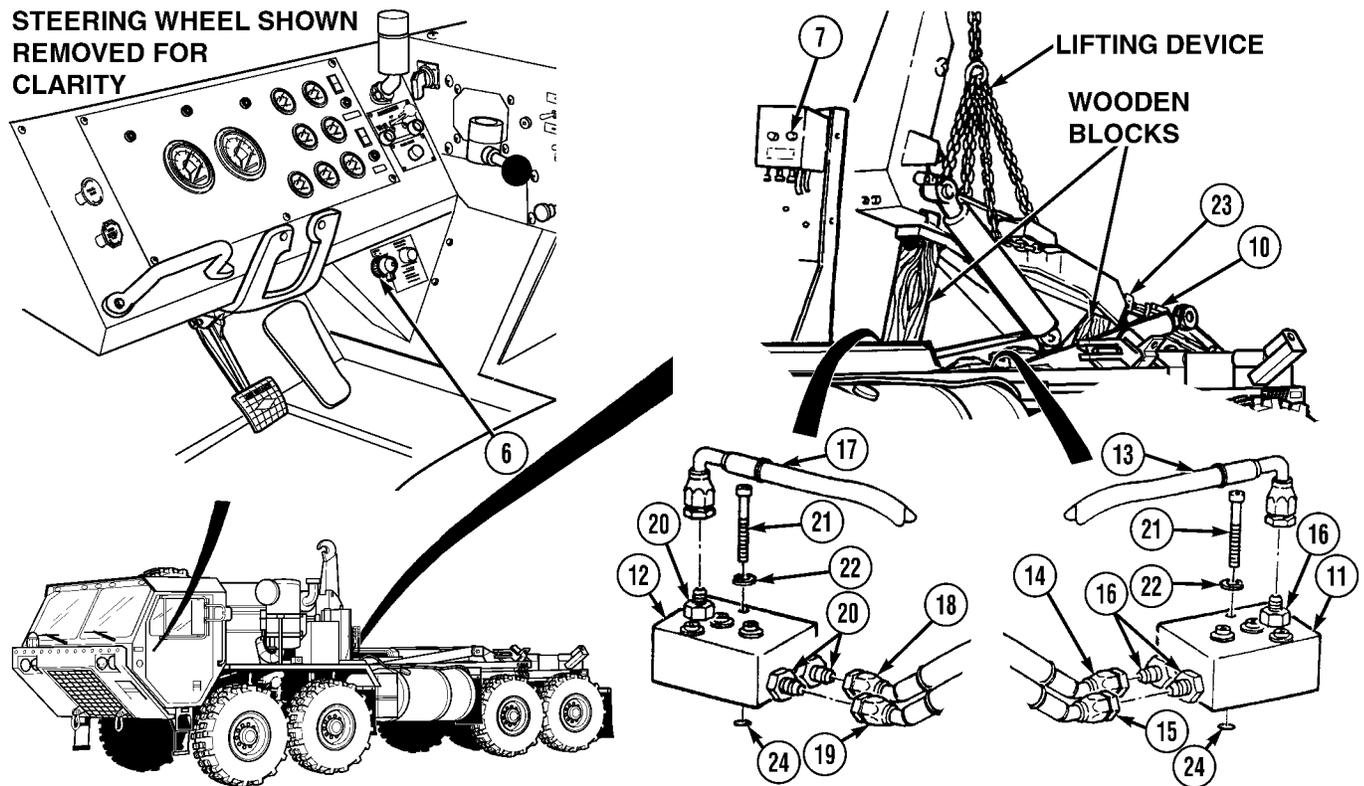

- (7) Position drain pan under left main frame cylinder manifold (11) and right main frame cylinder manifold (12).

WARNING

The LHS hydraulic system operates at oil pressures up to 1,725 psi (11 894 kPa). Never disconnect any hydraulic line or fitting without first dropping pressure to zero. Failure to comply may result in serious injury or death to personnel.

NOTE

- Tag and mark all hoses prior to removal.
 - Cap and plug all hydraulic hoses and fittings after disconnecting.
- (8) Press main safe lowering button (7) to relieve hydraulic pressure.
- (9) Turn ENGINE switch (6) to OFF position.
- (10) Remove hose 2889 (13), hose 2588 (14), and hose 2888 (15) from fittings (16) on left main manifold (11).
- (11) Remove hose 2890 (17), hose 2887 (18), and hose 2666 (19) from fittings (20) on right main manifold (12).
- (12) Remove eight screws (21), lockwashers (22), and left and right main frame cylinder manifolds (11 and 12) from left and right main cylinders (10 and 23). Discard lockwashers.
- (13) Remove and discard four preformed packings (24) from left and right main frame cylinder manifolds (11 and 12).

Direct Support and General Support Maintenance (Cont)

5-39. LOAD HANDLING SYSTEM (LHS) MAIN FRAME CYLINDER MANIFOLD REPAIR (CONT).

b. Disassembly.

CAUTION

- Velocity fuse will fall out when adapter is removed. Use care when removing adapter, or damage to equipment may result.
- Velocity fuse will not work correctly if installed backwards. Observe and record direction of valve during removal. Failure to comply may result in damage to equipment.

NOTE

Tag and mark ports that velocity fuse, relief valve, adapters, and plug are removed from prior to disassembly.

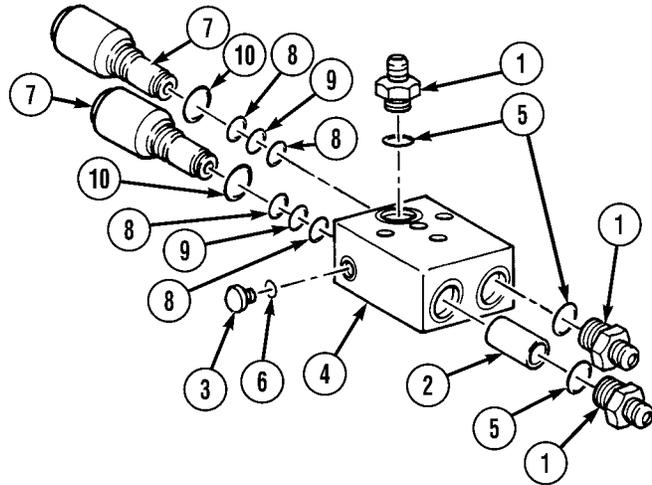

- (1) Remove three adapters (1), velocity fuse (2), and hex head plug (3) from main frame cylinder manifold (4).
- (2) Remove three preformed packings (5) from adapter (1). Discard preformed packings.
- (3) Remove preformed packing (6) from hex head plug (3). Discard preformed packing.
- (4) Remove two relief valves (7) from main frame cylinder manifold (4).
- (5) Remove two backup rings (8), preformed packings (9), and preformed packings (10) from each relief valve (7). Discard backup rings and preformed packings.

Direct Support and General Support Maintenance (Cont)

c. Cleaning/Inspection.

WARNING

- Drycleaning solvent (P-D-680) is TOXIC and flammable. Wear protective goggles, face shield, and gloves; use only in a well-ventilated area; avoid contact with skin, eyes, and clothes; and do not breathe vapors. Keep away from heat of flame. Never smoke when using solvent. The flashpoint for Type III Drycleaning Solvent is 200°F (93°C). Failure to do so may result in injury or death to personnel.
- If personnel becomes dizzy while using cleaning solvent, immediately get fresh air and medical help. If solvent contacts skin or clothes, flush with cold water. If solvent contacts eyes, immediately flush eyes with water and get immediate medical attention.

- (1) Clean main frame cylinder manifold and components using drycleaning solvent (P-D-680).
- (2) Inspect for any foreign material in ports and remove as necessary.
- (3) Inspect for cracks, dents, gouges, or stripped threads.
- (4) Replace all damaged parts.

d. Assembly.

- (1) Apply hydraulic oil to two preformed packings (1), preformed packings (2), and four backup rings (3).
- (2) Install two preformed packings (1), preformed packing (2), and four backup rings (3) on two relief valves (4).
- (3) Install two relief valves (4) in main frame cylinder manifold (5).
- (4) Apply hydraulic oil to preformed packing (6).
- (5) Install preformed packing (6) on hex head plug (7).
- (6) Install hex head plug (7) in main frame cylinder manifold (5).
- (7) Apply hydraulic oil to three preformed packings (8).
- (8) Install three preformed packings (8) on adapters (9).

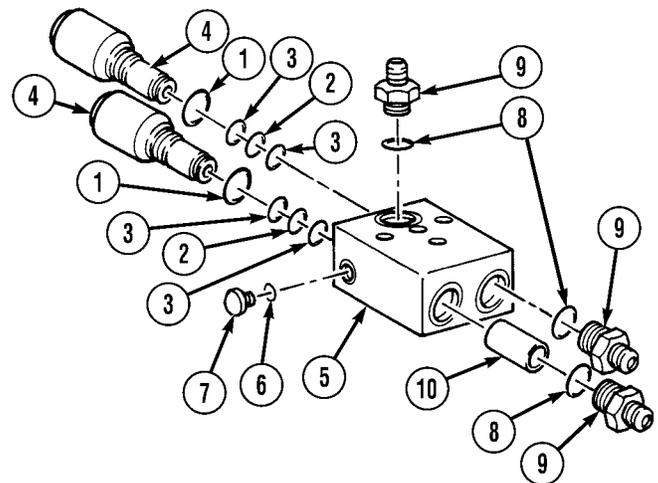

CAUTION

Velocity fuse will not work correctly if installed backwards. Install fuse as noted during removal. Failure to comply may result in damage to equipment.

- (9) Install velocity fuse (10) and three adapters (9) in main frame cylinder manifold (5).

Direct Support and General Support Maintenance (Cont)

5-39. LOAD HANDLING SYSTEM (LHS) MAIN FRAME CYLINDER MANIFOLD REPAIR (CONT).

e. Installation.

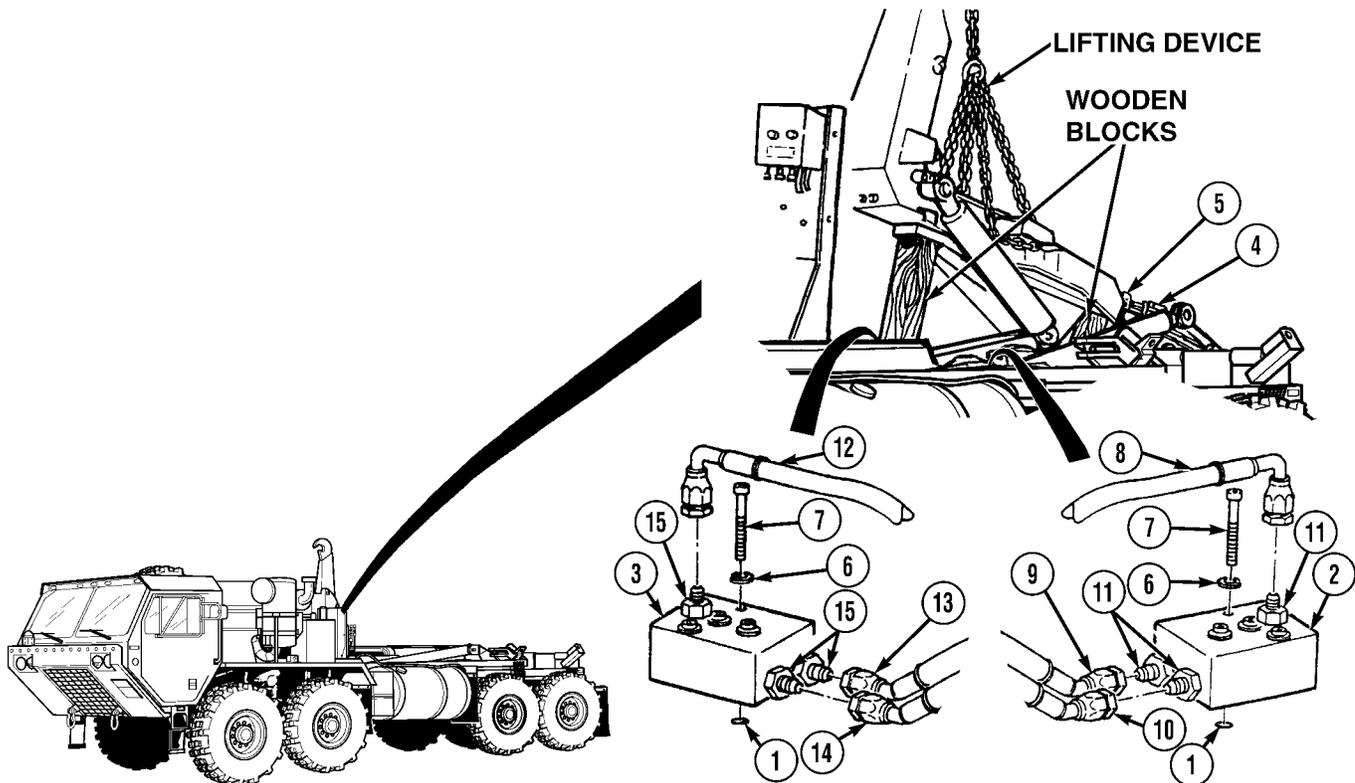

- (1) Apply hydraulic oil to four preformed packings (1).
- (2) Install four preformed packings (1) on left and right main frame cylinder manifolds (2 and 3).
- (3) Install left and right main frame cylinder manifolds (2 and 3) on main cylinders (4 and 5) with eight lockwashers (6) and screws (7).

WARNING

Adhesives, solvents, and sealing compounds can burn easily, can give off harmful vapors, and are harmful to skin. To avoid injury or death, keep away from open fire and use in well-ventilated area. If adhesives, solvent, or sealing compound gets on skin or clothing, wash immediately with soap and water.

- (4) Apply sealing compound in countersunk hole and around head of eight screws (7).
- (5) Install hose 2889 (8), hose 2588 (9), and hose 2888 (10) on fittings (11) on left main frame cylinder manifold (2).
- (6) Install hose 2890 (12), hose 2887 (13), and hose 2666 (14) on fittings (15) on right main frame cylinder manifold (3).

Direct Support and General Support Maintenance (Cont)

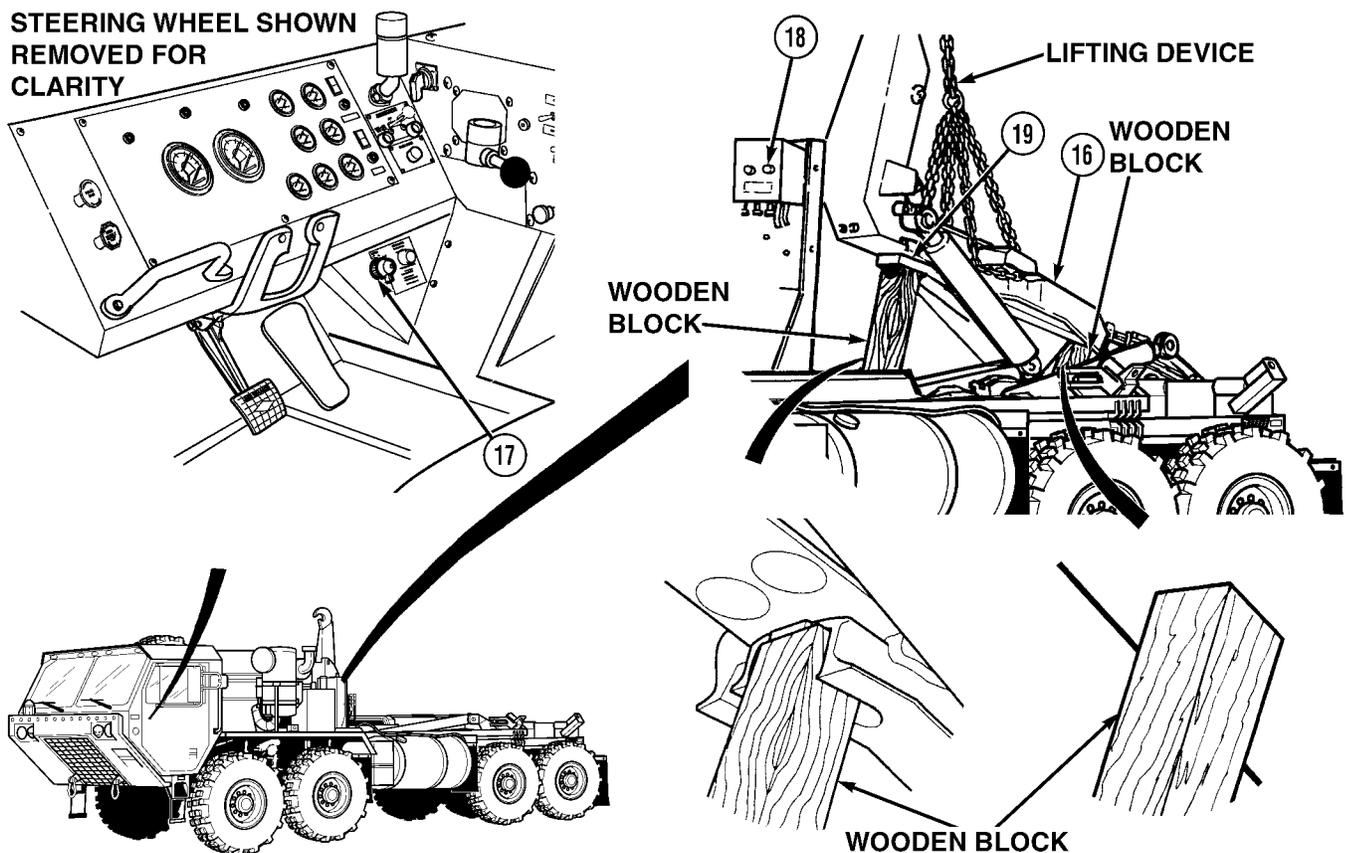
**WARNING**

Main frame and hook arm combined weight is 2,100 lbs. (953 kg). Attach suitable lifting device prior to installation to prevent possible injury to personnel.

CAUTION

Blocks supporting main frame can fall when main frame is supported with a lifting device. Have soldier prevent wooden blocks from falling or damage to equipment may result.

- (7) Attach lifting device to hook arm (16).
- (8) Turn ENGINE switch (17) to ON position.
- (9) Soldier A presses main frame safe lowering button (18) while Soldier B, using lifting device, raises hook arm (16) and main frame (19), remove blocking and then lower main frame.
- (10) Turn ENGINE switch (17) to OFF position.
- (11) Remove lifting device from hook arm (16).

Direct Support and General Support Maintenance (Cont)

5-39. LOAD HANDLING SYSTEM (LHS) MAIN FRAME CYLINDER MANIFOLD REPAIR (CONT).

- (12) Install main junction box cover (20), four lockwashers (21), and screws (22) on bracket (23).

f. Follow-on Maintenance.

- (1) Start engine (TM 9-2320-279-10).
- (2) Operate LHS (Para 2-9).
- (3) Check for oil leaks (TM 9-2320-279-10).
- (4) Shut OFF engine (TM 9-2320-279-10).
- (5) Check hydraulic oil reservoir level (TM 9-2320-279-20).
- (6) Remove wheel chocks (TM 9-2320-279-10).

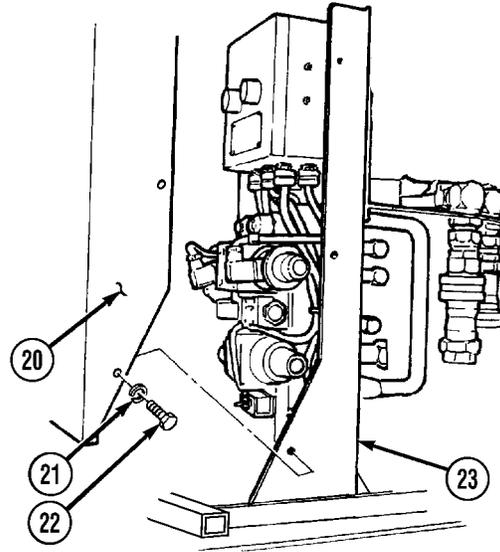

END OF TASK

5-40. LOAD HANDLING SYSTEM (LHS) MAIN FRAME CYLINDER REPLACEMENT.

This task covers:

- a. Removal
- b. Installation
- c. Follow-on Maintenance

INITIAL SETUP

Models

M1120

Personnel Required

MOS 63W, Wheel vehicle repairer

Test Equipment

None

References

None

Special Tools

- Tool Kit, General Mechanic's, Item 32, Appendix B
- Pan, Drain 4 gal, Item 16, Appendix B
- Wrench Torque (0-175 lb ft. [0-237 N•m]), Item 48, Appendix B
- Wooden Blocks (2), Appendix H

Equipment Condition

<i>TM or Para</i>	<i>Condition Description</i>
TM 9-2320-279-10	Engine OFF
TM 9-2320-279-10	Wheels chocked
Para 5-39	Main frame cylinder manifold removed

Supplies

- Oil Hydraulic, Item 12, Appendix F
- Locknut (2), Item 5, Appendix K

Special Environmental Conditions

None

General Safety Instructions

None

Direct Support and General Support Maintenance (Cont)

a. Removal.

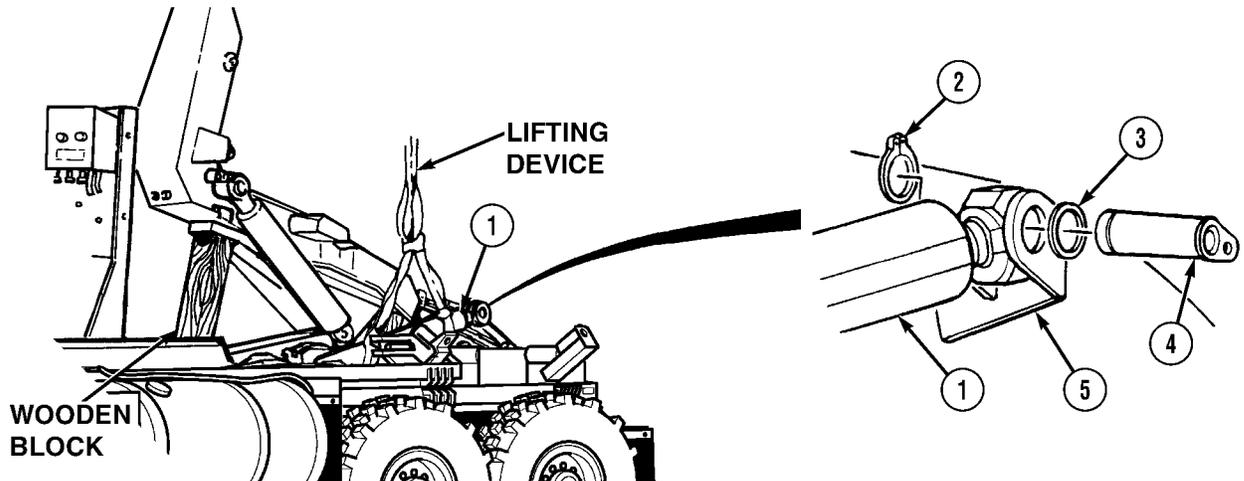

WARNING

- Main frame cylinder weighs 325 lbs. (148 kg). Attach suitable lifting device prior to removal to prevent possible injury to personnel.
- Use care when removing retaining rings. Retaining rings are under tension and can act as projectiles when released causing injury to personnel.

- (1) Attach lifting device to main frame cylinder (1).
- (2) Support main frame cylinder (1) using lifting device and remove retaining ring (2), shim (3), and pivot pin (4) from main frame (5) and main frame cylinder (1).

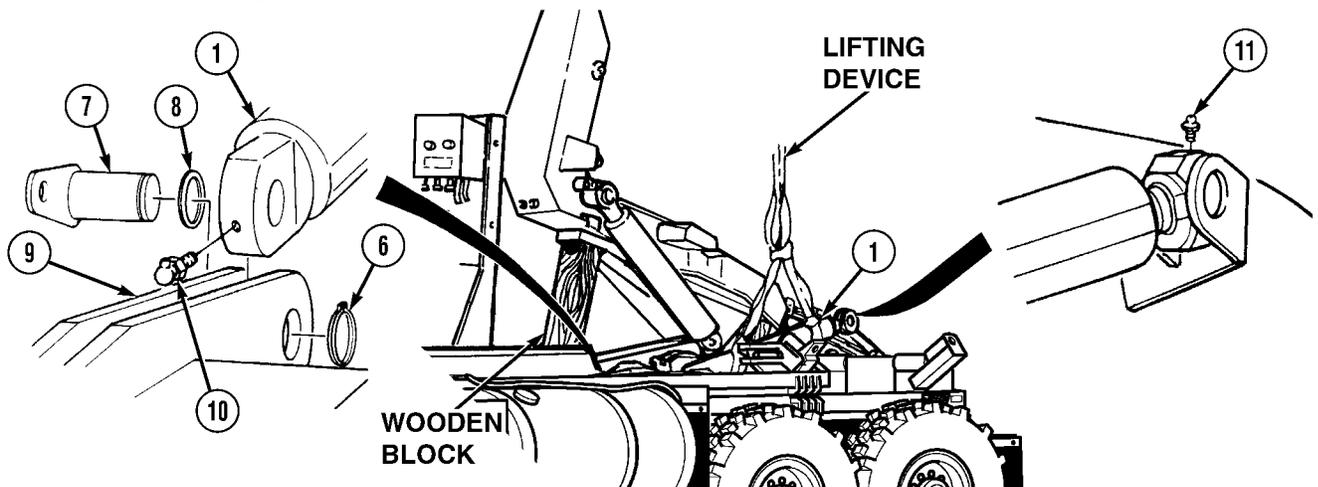

- (3) Remove retaining ring (6), pivot pin (7), and shim (8) from compression frame (9) and main frame cylinder (1).
- (4) Remove main frame cylinder (1) from compression frame (9).

NOTE

Do step (5) if lube fittings are damaged.

- (5) Remove lube fittings (10 and 11) from main frame cylinder (1).

Direct Support and General Support Maintenance (Cont)

5-40. LOAD HANDLING SYSTEM (LHS) MAIN FRAME CYLINDER REPLACEMENT (CONT).

b. Installation.

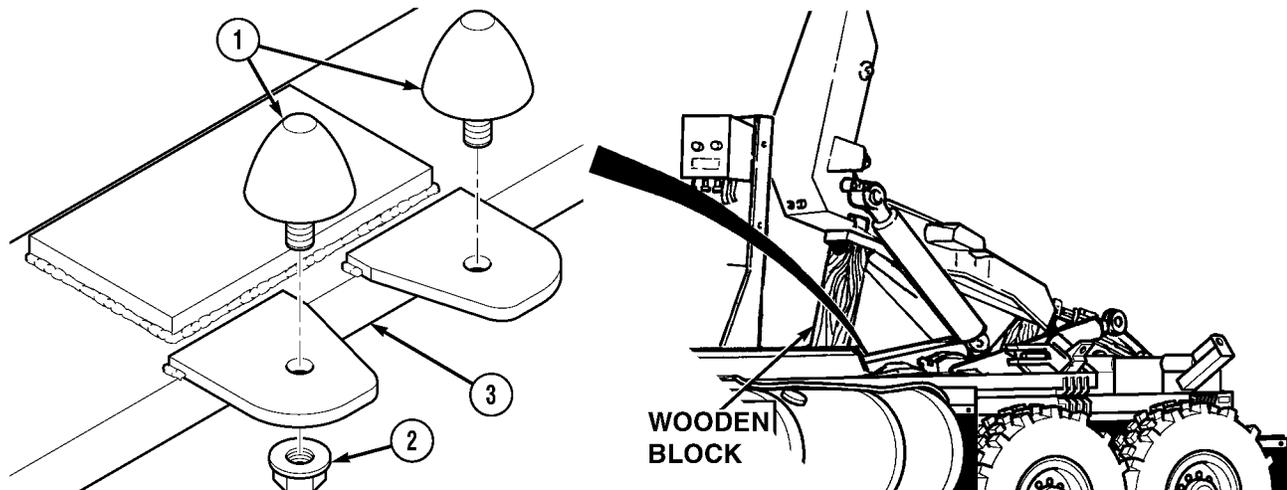

(1) Remove two rubber bumpers (1) and locknuts (2) from compression frame (3). Discard locknut.

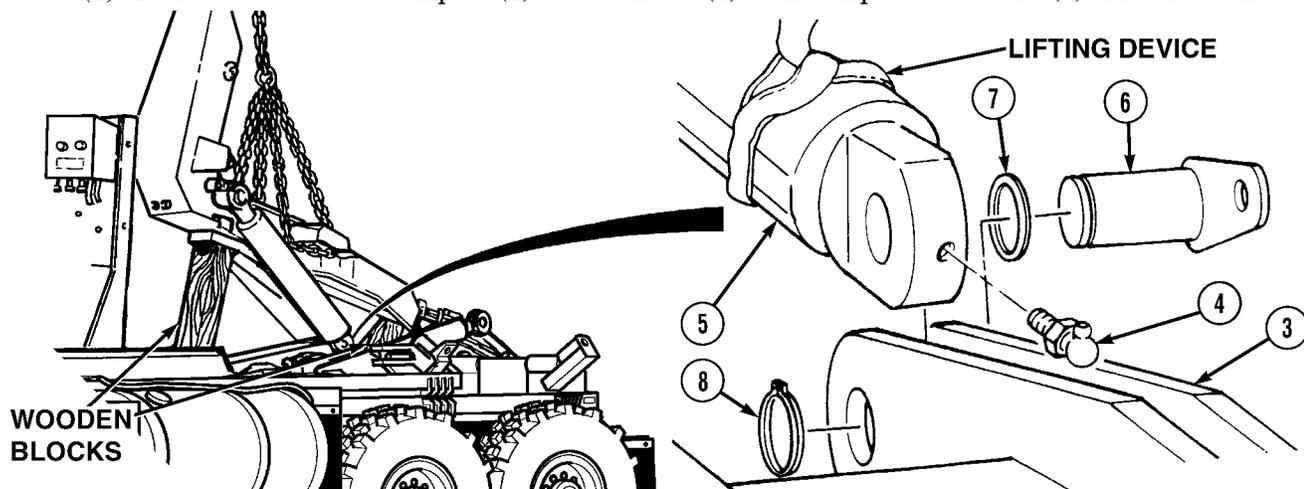

(2) Install lube fitting (4) in main frame cylinder (5).

WARNING

Main frame cylinder weighs 325 lbs. (148 kg). Attach suitable lifting device prior to installation to prevent possible injury to personnel.

(3) Attach lifting device to main frame cylinder (5).

WARNING

Use care when installing retaining rings. Retaining rings are under tension and can act as projectiles when released causing injury to personnel.

(4) Using lifting device, install barrel end of main frame cylinder (5), pivot pins (6), shim (7), and retaining ring (8) on compression frame (3).

(5) Remove lifting device from main frame cylinder (5).

Direct Support and General Support Maintenance (Cont)

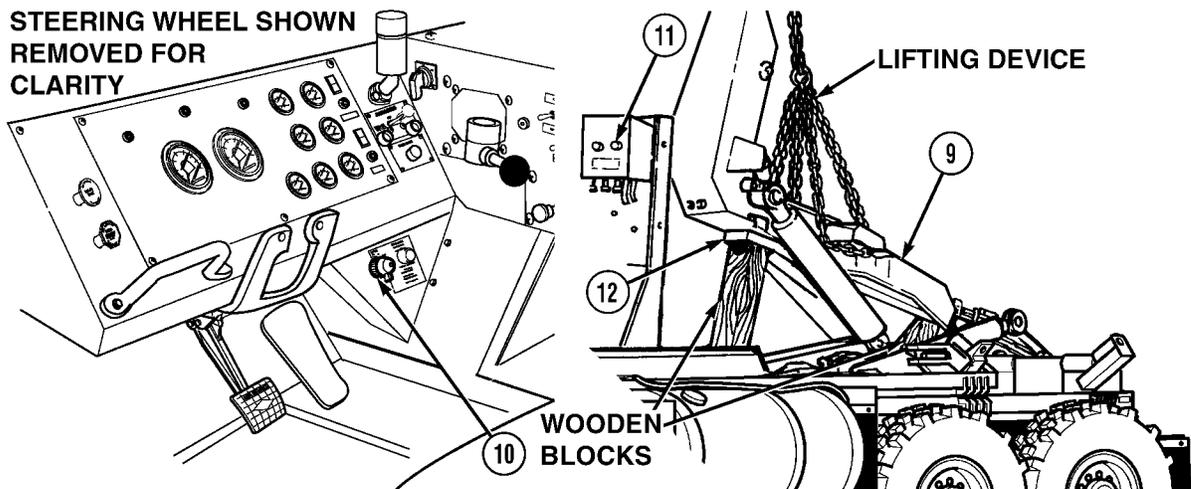

WARNING

Main frame and hook arm have a combined weight of 2,100 lbs. (953 kg). Hook arm cylinders weigh 210 lbs. (95 kg) each. Attach suitable lifting device prior to removal to prevent possible injury to personnel.

CAUTION

Blocks supporting main frame can fall when main frame is supported by a lifting device. Have soldier prevent wooden blocks from falling or damage to equipment may result.

- (6) Attach lifting device to hook arm (9).
- (7) Turn ENGINE switch (10) to ON position.
- (8) Soldier A press main frame safe lowering button (11) while Soldier B, using lifting device, raises hook arm (9) and main frame (12).
- (9) Remove wooden block and then lower hook arm (9) and main frame (12).
- (10) Turn ENGINE switch (10) to OFF position
- (11) Remove lifting device from hook arm (9).

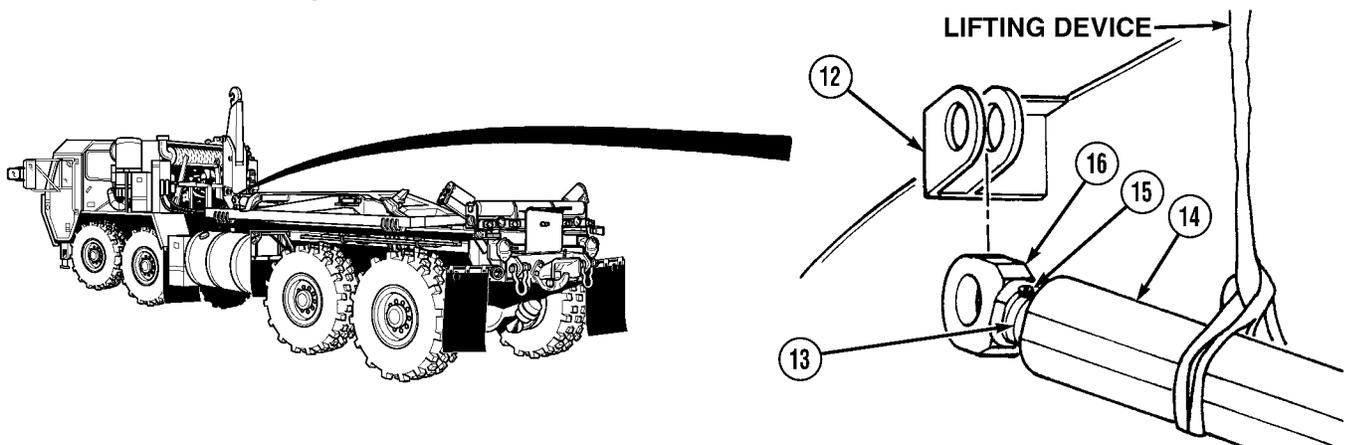

- (12) Fully compress cylinder rod (13) in barrel (14).
- (13) Extend cylinder rod (13) out 1/4 in. (6.4 mm), loosen screw (15), and rotate rod lug (16) so lug bore aligns with holes in main frame (12). Tighten screw (15) to 41 lb-ft. (56 N•m).

Direct Support and General Support Maintenance (Cont)

5-40. LOAD HANDLING SYSTEM (LHS) MAIN FRAME CYLINDER REPLACEMENT (CONT).

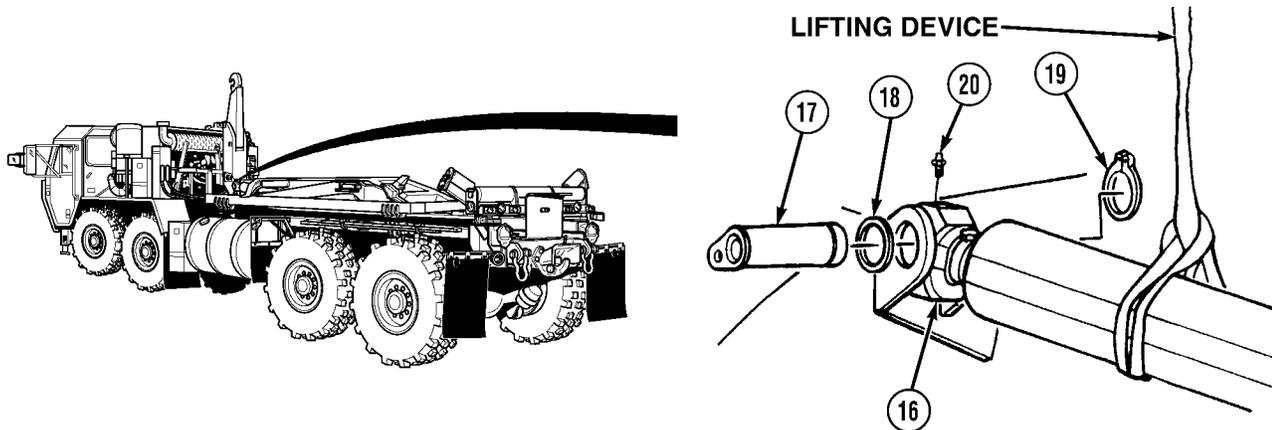

WARNING

Use care when installing retaining rings. Retaining rings are under tension and can act as projectiles when released causing injury to personnel.

- (14) When lug bore and main frame holes aline, install rod lug (16) with pivot pin (17), shim (18), and retaining ring (19).

NOTE

Do step (15) if lube fitting was removed.

- (15) Install lube fitting (20) in rod lug (16).

Direct Support and General Support Maintenance (Cont)

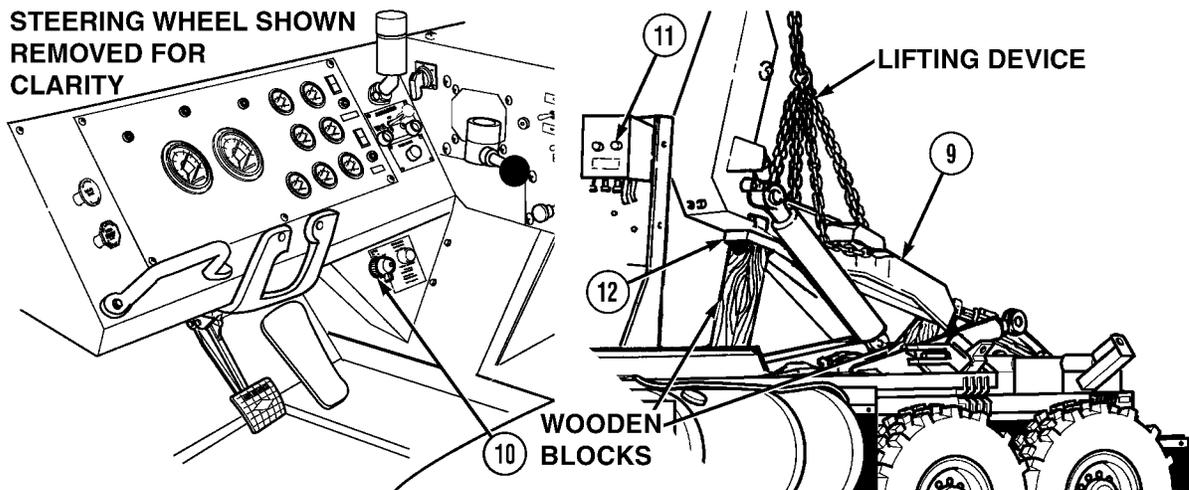

WARNING

Main frame and hook arm combined weight is 2,100 lbs. (953 kg). Attach suitable lifting device prior to installation to prevent possible injury to personnel.

CAUTION

Wooden blocks supporting main frame can fall when main frame is supported with a lifting device. Have soldier prevent wooden blocks from falling or damage to equipment may result.

- (16) Attach lifting device to hook arm (9).
- (17) Turn ENGINE switch (10) to ON position.
- (18) Soldier A press main frame safe lowering button (11) while Soldier B, using lifting device, raises hook arm (9) and main frame (12).
- (19) Support main frame (12) in two places with wooden blocks.
- (20) Turn ENGINE switch (10) to OFF position.
- (21) Remove lifting device from hook arm (9).

WARNING

Adhesives, solvents, and sealing compounds can burn easily, can give off harmful vapors, and are harmful to skin and clothing. To avoid injury or death, keep away from open fire and use in a well-ventilated area. If adhesive, solvent, or sealing compound gets on skin or clothing, wash immediately with soap and water.

- (22) Coat threads of two rubber bumpers (1) with sealing compound.
- (23) Install two rubber bumpers (1) on compression frame (3) with locknuts (2).

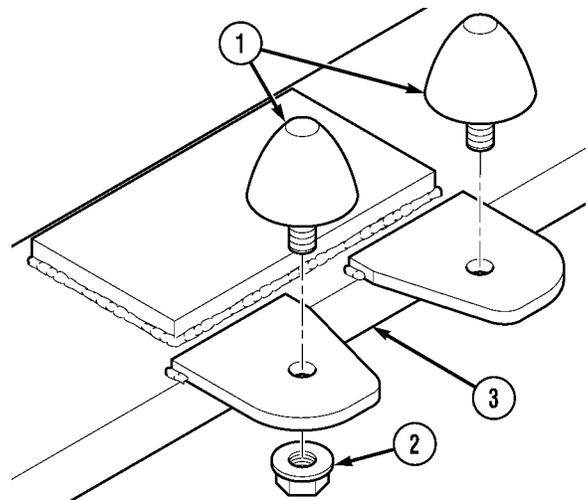

c. Follow-on Maintenance.

- (1) Install main cylinder manifold (Para 5-39).
- (2) Remove wheel chocks (TM 9-2320-279-10).

END OF TASK

Direct Support and General Support Maintenance (Cont)

5-41. LOAD HANDLING SYSTEM (LHS) LOAD CONTROL VALVE MAIN FRAME REPLACEMENT.							
This task covers:							
a. Removal	b. Installation						
c. Follow-on Maintenance							
INITIAL SETUP							
<i>Models</i> M1120	<i>Personnel Required</i> MOS 63W, Wheel vehicle repairer						
<i>Test Equipment</i> None	<i>References</i> None						
<i>Special Tools</i> Tool Kit, General Mechanic's, Item 32, Appendix B Pan, Drain 4 gal, Item 16, Appendix B Wrench, Combination 1-1/2 in., Item 39, Appendix B Wrench, Torque (0-175 lb-ft. [0-237 N•m]), Item 48, Appendix B	<i>Equipment Condition</i> <table border="0"> <tr> <td><i>TM or Para</i></td> <td><i>Condition Description</i></td> </tr> <tr> <td>TM 9-2320-279-10</td> <td>Engine OFF</td> </tr> <tr> <td>TM 9-2320-279-10</td> <td>Wheels chocked</td> </tr> </table> <i>Special Environmental Conditions</i> None	<i>TM or Para</i>	<i>Condition Description</i>	TM 9-2320-279-10	Engine OFF	TM 9-2320-279-10	Wheels chocked
<i>TM or Para</i>	<i>Condition Description</i>						
TM 9-2320-279-10	Engine OFF						
TM 9-2320-279-10	Wheels chocked						
<i>Supplies</i> Oil, Hydraulic, Item 12, Appendix F Lockwasher (4), Item 17, Appendix K Prefomed Packing Kit, Item 40, Appendix K	<i>General Safety Instructions</i> None						

Direct Support and General Support Maintenance (Cont)

a. Removal.

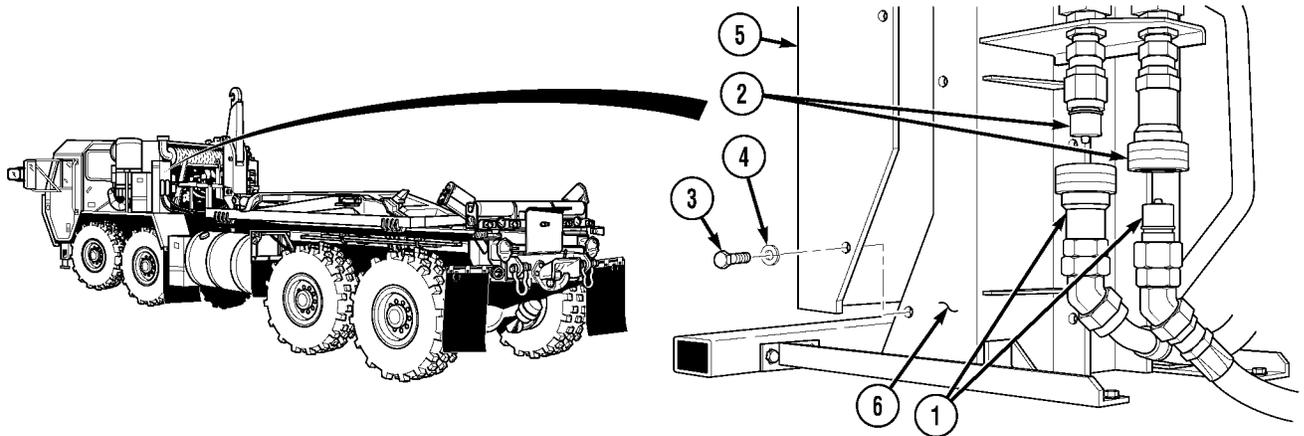

WARNING

The LHS hydraulic system operates at oil pressures up to 1,725 psi (11 894 kPa). Never disconnect any hydraulic line or fitting without first dropping pressure to zero. Failure to comply may result in serious injury or death to personnel.

- (1) Disconnect two hose quick disconnects (1) from main control box quick disconnects (2).

NOTE

Only remove center screw on engine side of LHS control box cover.

- (2) Remove four screws (3), lockwashers (4), and LHS control box cover (5) from bracket (6). Discard lockwashers.

Direct Support and General Support Maintenance (Cont)

5-41. LOAD HANDLING SYSTEM (LHS) LOAD CONTROL VALVE MAIN FRAME REPLACEMENT (CONT).

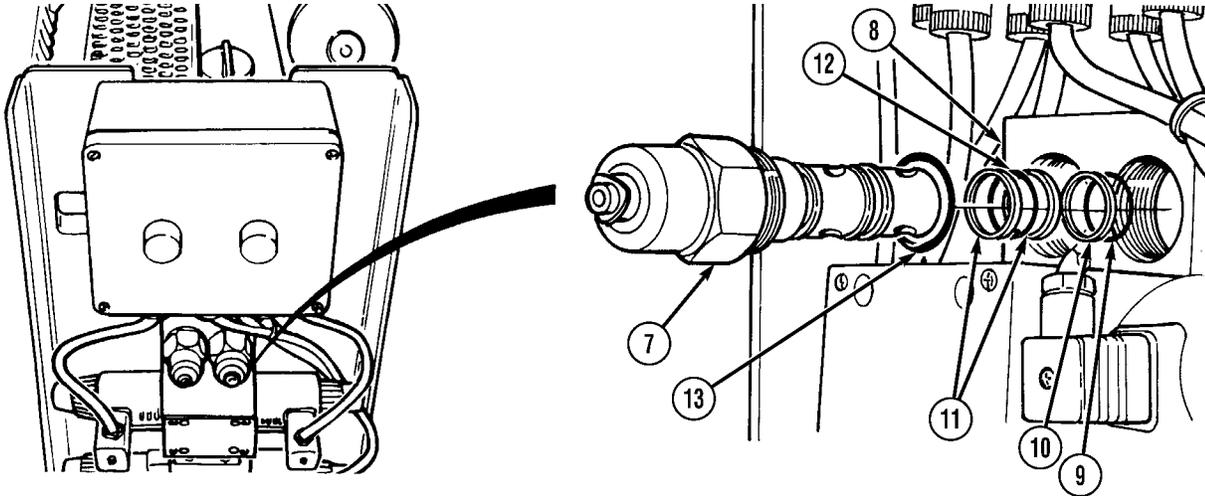

NOTE

- Both load control valves are removed the same way.
- Left side (outside) load control valve controls loading.
- Right side (inside) load control valve controls unloading.

- (3) Position drain pan under load control valves (7).
- (4) Remove load control valve (7) from hydraulic manifold (8).
- (5) Remove preformed packing (9), backup ring (10), two backup rings (11), preformed packing (12), and preformed packing (13) from load control valve (7). Discard preformed packings and backup rings.

Direct Support and General Support Maintenance (Cont)

b. Installation

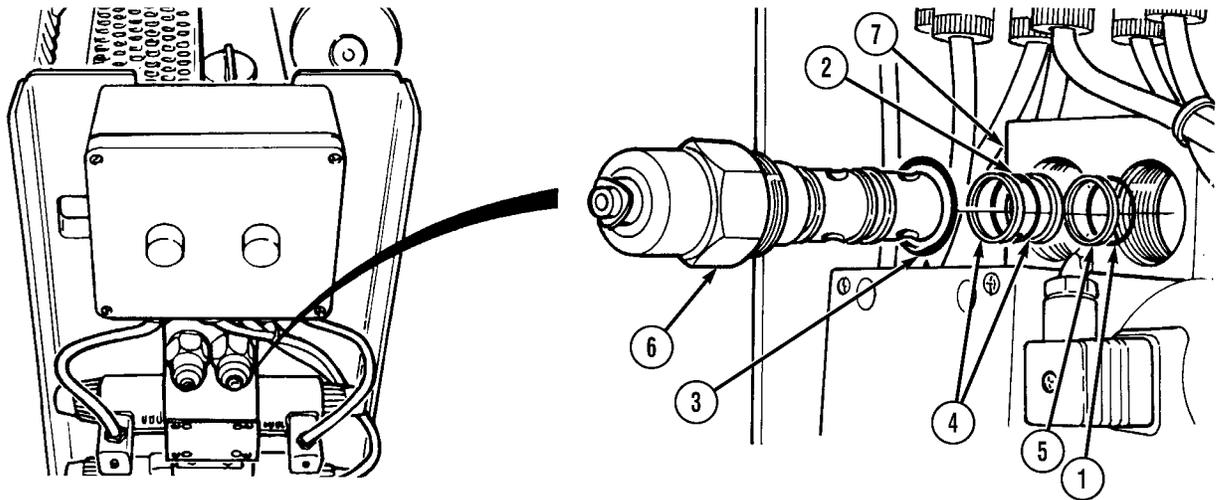

CAUTION

Preformed packing, backup ring, and sealing ring assembly are very similar in size. The last preformed packing to be installed and its backup ring are the smallest in size. If these components fit loosely or tightly on load control valve, they are installed in the incorrect position. Damage to equipment may result.

- (1) Apply hydraulic oil to preformed packings (1, 2, and 3) and backup rings (4 and 5).
- (2) Install preformed packing (3), preformed packing (2), two backup rings (4), backup ring (5) and preformed packing (1) on load control valve (6).
- (3) Install load control valve (6) in hydraulic manifold (7). Tighten valve to 75 lb-ft. (102 N•m).
- (4) Install LHS control box cover (8) on bracket (9) with four lockwashers (10) and screws (11).
- (5) Connect two hose quick disconnects (12) on main control box quick disconnects (13).

c. Follow-on Maintenance.

- (1) Start engine (TM 9-2320-279-10).
- (2) Operate LHS (Para 2-9).
- (3) Check for oil leaks (TM 9-2320-279-10).
- (4) Shut OFF engine (TM 9-2320-279-10).
- (5) Check hydraulic oil reservoir level (TM 9-2320-279-20).
- (6) Remove wheel chocks (TM 9-2320-279-10).

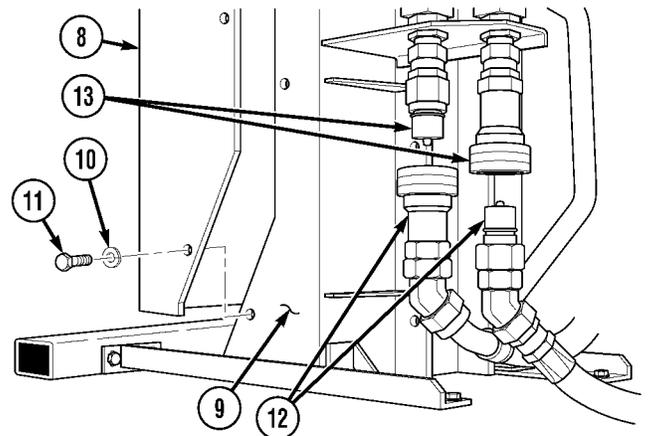

END OF TASK

Direct Support and General Support Maintenance (Cont)

5-42. LOAD HANDLING SYSTEM (LHS) CHECK VALVE REPLACEMENT.		
This task covers:		
a. Removal	b. Installation	c. Follow-on Maintenance
INITIAL SETUP		
<i>Models</i> M1120	<i>Personnel Required</i> MOS 63W, Wheel vehicle repairer	
<i>Test Equipment</i> None	<i>References</i> None	
<i>Special Tools</i> Tool Kit, General Mechanic's, Item 32, Appendix B Pan, Drain 4 gal, Item 16, Appendix B Wrench, Torque (0-175 lb ft. [0-237 N•m]), Item 48, Appendix B	<i>Equipment Condition</i> <i>TM or Para</i> <i>Condition Description</i> TM 9-2320-279-10 Engine OFF TM 9-2320-279-10 Wheels chocked	
<i>Supplies</i> Oil, Hydraulic, Item 12, Appendix F Lockwasher (4), Item 20, Appendix K Prefomed Packing Kit, Item 31, Appendix K	<i>Special Environmental Conditions</i> None	
	<i>General Safety Instructions</i> None	

Direct Support and General Support Maintenance (Cont)

a. Removal.

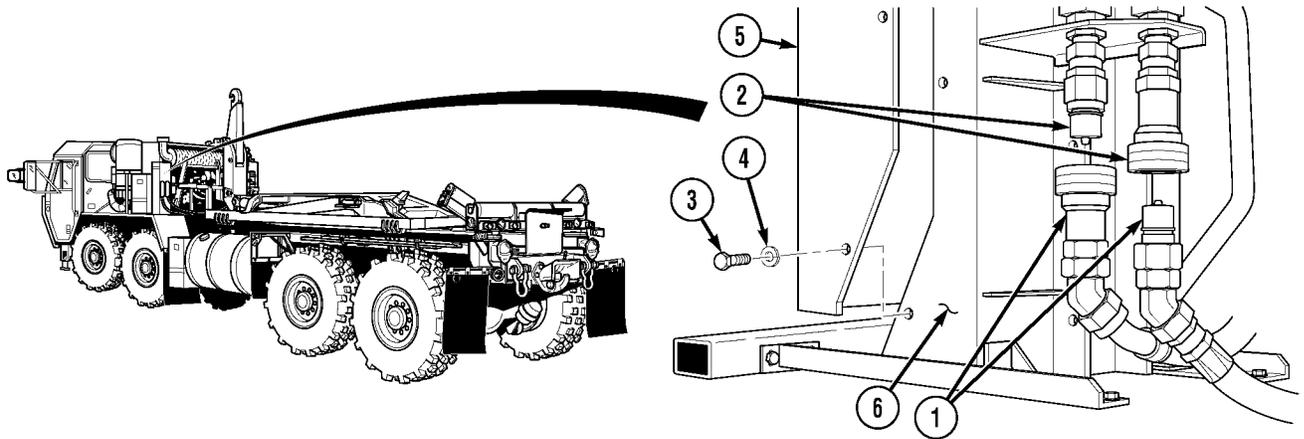

WARNING

The LHS hydraulic system operates at oil pressures up to 1,725 psi (11 894 kPa). Never disconnect any hydraulic line or fitting without first dropping pressure to zero. Failure to comply may result in serious injury or death to personnel.

- (1) Disconnect two hose quick disconnects (1) from LHS control box quick disconnects (2).

NOTE

Only remove center screw on engine side of LHS control box cover.

- (2) Remove four screws (3), lockwashers (4), and LHS control box cover (5) from bracket (6). Discard lockwashers.
- (3) Position drain pan under check valve (7).
- (4) Remove check valve (7) from hydraulic manifold (8).
- (5) Remove backup ring (9), two preformed packings (10 and 11) from check valve (7). Discard backup ring and preformed packings.

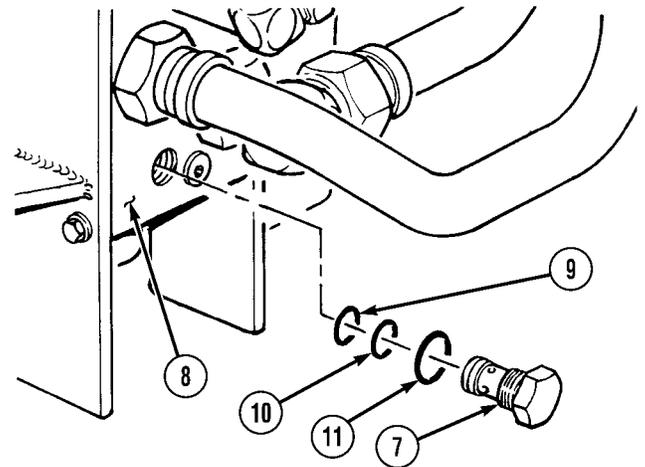

Direct Support and General Support Maintenance (Cont)

5-42. LOAD HANDLING SYSTEM (LHS) CHECK VALVE REPLACEMENT (CONT).

b. Installation.

- (1) Apply hydraulic oil to two preformed packings (1 and 2) and backup ring (3).
- (2) Install two preformed packings (1 and 2) and backup ring (3) on check valve (4).
- (3) Install check valve (4) in hydraulic manifold (5). Tighten valve to 45 lb-ft. (61 N•m).

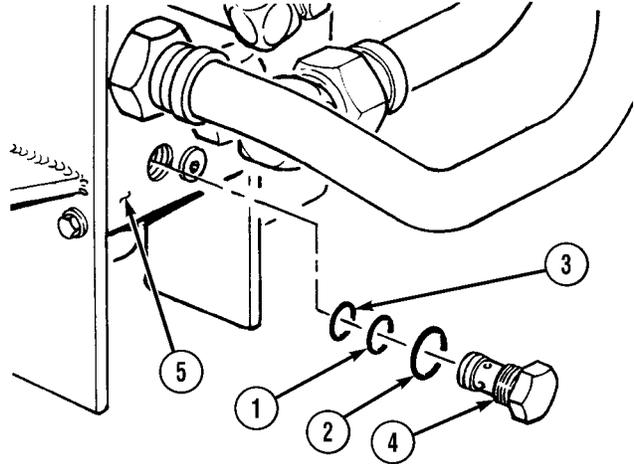

- (4) Install LHS control box cover (6) on bracket (7) with four lockwashers (8) and screws (9).
- (5) Connect two hose quick disconnects (10) on LHS control box quick disconnects (11).

c. Follow-on Maintenance.

- (1) Start engine (TM 9-2320-279-10).
- (2) Operate LHS (Para 2-9).
- (3) Check for oil leaks (TM 9-2320-279-10).
- (4) Shut OFF engine (TM 9-2320-279-10).
- (5) Check hydraulic oil reservoir level (TM 9-2320-279-20).
- (6) Remove wheel chocks (TM 9-2320-279-10).

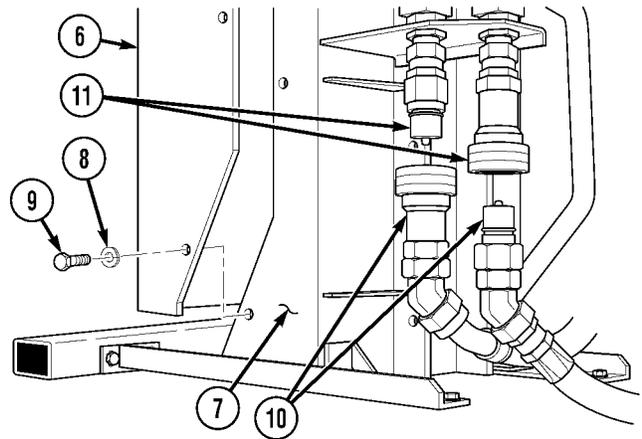

END OF TASK

Direct Support and General Support Maintenance (Cont)

5-43. CONTAINER HANDLING UNIT (CHU) KIT INSTALLATION.

This task covers:

- a. Installation
- b. Adjustment
- c. Follow-on Maintenance

INITIAL SETUP

Models

M1120

Test Equipment

None

Special Tools

- Tool Kit, General Mechanic's, Item 32, Appendix B
- Clamp, Machinist (4), Item 2.1, Appendix B
- Pliers, Retaining Ring, Item 19.1, Appendix B
- Wrench, Torque (0-175 lb-ft [0-237 N•m]), Item 48, Appendix B
- Wrench, Torque (0-175 lb-ft [0-237 N•m]), Item 49, Appendix B
- Chain, 3 ft. or 4 ft.
- Lifting Device, Minimum Capacity 2000 lbs. (907 kg)
- Tool Kit, General Mechanic's: Automotive, Item 33, Appendix B
- Gage, Feeler, Item 9, Appendix B
- Goggles, Industrial, Item 12, Appendix B
- Compressor Unit, Air, Item 2.2, Appendix B
- Gloves, Chemical Oil Protective, Item 11, Appendix B
- Gun, Air Blow, Item 12.1, Appendix B
- Pliers, Retaining Ring, Item 19, Appendix B
- Puller Kit, Universal, Item 19.2, Appendix B
- Lifting Device, Minimum Capacity 140 lbs. (64 kg)
- Lifting Device, Minimum Capacity 240 lbs. (109 kg)
- Lifting Device, Minimum Capacity 375 lbs. (170 kg)
- Lifting Device, Minimum Capacity 200 lbs. (91 kg)

Special Tools (cont)

- Compressor Unit, Air, Item 2.2, Appendix B
- Lifting Device, Minimum Capacity 400 lbs. (181 kg)
- Lifting Device, Minimum Capacity 500 lbs. (227 kg)

Supplies

- Adhesive (1), Item 1, Appendix F
- Cable tie (4), Item 4, Appendix F
- Antiseize Compound (2), Item 6, Appendix F
- Antiseize Compound (1), Item 6.1, Appendix F
- Epoxy, Item 7.2, Appendix F
- Grease (2), Item 8, Appendix F
- Sealing Compound (1), Item 15, Appendix F
- Sealing Compound (1), Item 15.1, Appendix F
- Sealing Compound (9), Item 16, Appendix F
- Solvent, Drycleaning (1), Item 18, Appendix F
- Tag, Identification (4), Item 19, Appendix F
- Locknut (12), Item 1, Appendix K
- Locknut (6), Item 2, Appendix K
- Locknut (88), Item 2.1, Appendix K
- Locknut (63), Item 3, Appendix K
- Locknut (11), Item 3.1, Appendix K
- Locknut (2), Item 3.2, Appendix K
- Locknut (1), Item 4, Appendix K
- Locknut (4), Item 5, Appendix K
- Locknut (10), Item 10.1, Appendix K
- Locknut (2), Item 11, Appendix K
- Lockwasher (2), Item 14.1, Appendix K
- Lockwasher (2), Item 15, Appendix K
- Lockwasher (4), Item 18, Appendix K
- Lockwasher (4), Item 19, Appendix K

Direct Support and General Support Maintenance (Cont)

5-43. CONTAINER HANDLING UNIT (CHU) KIT INSTALLATION (CONT).

Supplies (cont)

- Lockwasher (2), Item 20, Appendix K
- Lockwasher (2), Item 23, Appendix K
- Pin, Cotter (2), Item 31.1, Appendix K
- Pin, Roll (1), Item 32.1, Appendix K
- Pin, Cotter (1), Item 32, Appendix K
- Plug, Hole (1), Item 32.3, Appendix K
- Screw, Self-Tapping (2), Item 42.1, Appendix K
- Seal (2), Item 43.1, Appendix K

Personnel Required

- MOS 63W, Wheel vehicle repairer (2)

References

- None

Equipment Condition

- | <i>TM or Para</i> | <i>Condition Description</i> |
|-------------------|------------------------------|
| TM 9-2320-279-10 | Engine OFF |
| TM 9-2320-279-10 | Wheels chocked |
| TM 9-2320-279-20 | Batteries disconnected |
| TM 9-2320-279-20 | Battery box removed |
| TM 9-2320-279-20 | Stowage box removed |
| Para 4-49 | Bumper stop bracket removed |
| Para 4-53 | Deck assembly removed |

Equipment Condition (cont)

- | <i>TM or Para</i> | <i>Condition Description</i> |
|-------------------|--|
| Para 2-12 | Ladder removed |
| Para 4-51.1 | Rear ladder bracket removed |
| Para 4-43 | Rear light bar removed |
| Para 4-48 | Rear roller assembly removed |
| Para 4-47 | Angled roller removed |
| Para 4-46 | Horizontal roller removed |
| TM 9-2320-279-20 | Self-recovery winch (SRW) rear tension guide removed (if equipped) |
| TM 9-2320-279-20 | Self-recovery winch (SRW) rear guide removed (if equipped) |
| TM 9-2320-279-20 | Fuel tank removed |
| TM 9-2320-279-20 | Rear composite light |
| Para 4-43 | Rear marked light assembly removed and disassembled |

Special Environmental Conditions

- None

General Safety Instructions

- None

Direct Support and General Support Maintenance (Cont)**a. Installation.****WARNING**

- Drycleaning solvent (P-D-680) is TOXIC and flammable. Wear protective goggles, face shield, and gloves; use only in a well-ventilated area; avoid contact with skin, eyes, and clothes; and do not breathe vapors. Keep away from heat or flame. Never smoke when using solvent. The flashpoint for Type III Drycleaning Solvent is 200° F (93° C). Failure to do so may result in injury or death to personnel.
- If personnel becomes dizzy while using cleaning solvent, immediately get fresh air and medical help. If solvent contacts skin or clothes, flush with cold water. If solvent contacts eyes, immediately flush eyes with water and get immediate medical attention.

CAUTION

Do not discard any removed parts until CHU installation is complete. Some parts will be reused.

NOTE

- Container Handling Unit (CHU) can only be installed on HEMTT M1120.
- Prior to installation, remove all banding and screws that were supporting CHU components during packaging and shipping.
- Remove all tags and protective coverings from components.
- Clean bare metal surfaces with drycleaning solvent prior to installation.
- It may be necessary to unpack boxes to locate required box.

Direct Support and General Support Maintenance (Cont)

5-43. CONTAINER HANDLING UNIT (CHU) KIT INSTALLATION (CONT).

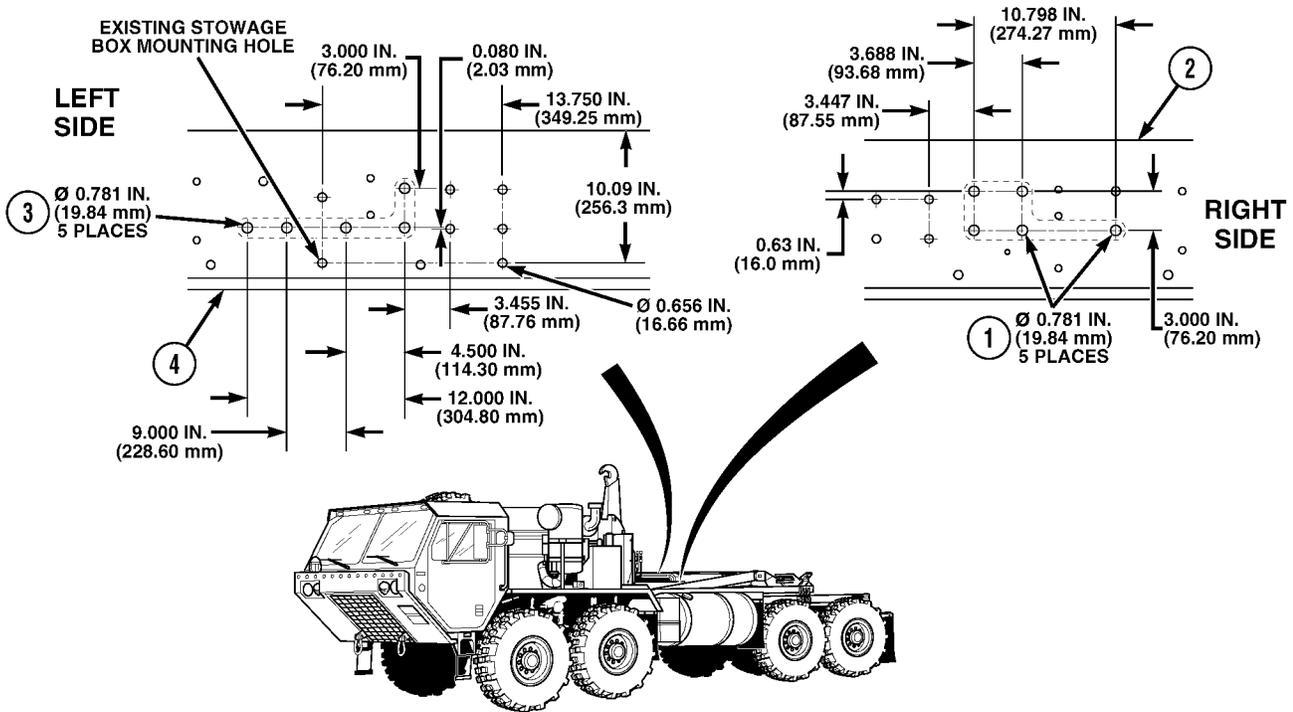

- (1) Measure and mark five new screw hole positions (1) on right-side frame rail (2).
- (2) Drill five 0.781-in. (19.84 mm) holes in right-side frame rail (2).
- (3) Measure and mark five new screw hole positions (3) for stowage box bracket on left-side frame rail (4).
- (4) Drill five 0.781-in. (19.84 mm) holes in left-side frame rail (4).

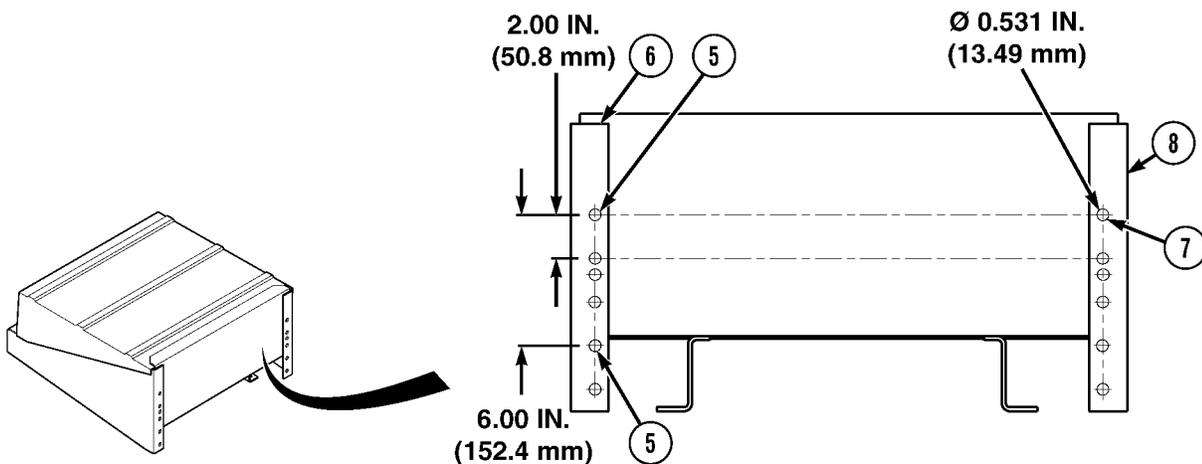

- (5) Measure distances shown and mark positions.
- (6) Drill two 0.531-in. (13.49 mm) holes (5) in right-side battery box bracket (6) and one 0.531-in. (13.49 mm) hole (7) in left-side battery box bracket (8) as shown.

Direct Support and General Support Maintenance (Cont)

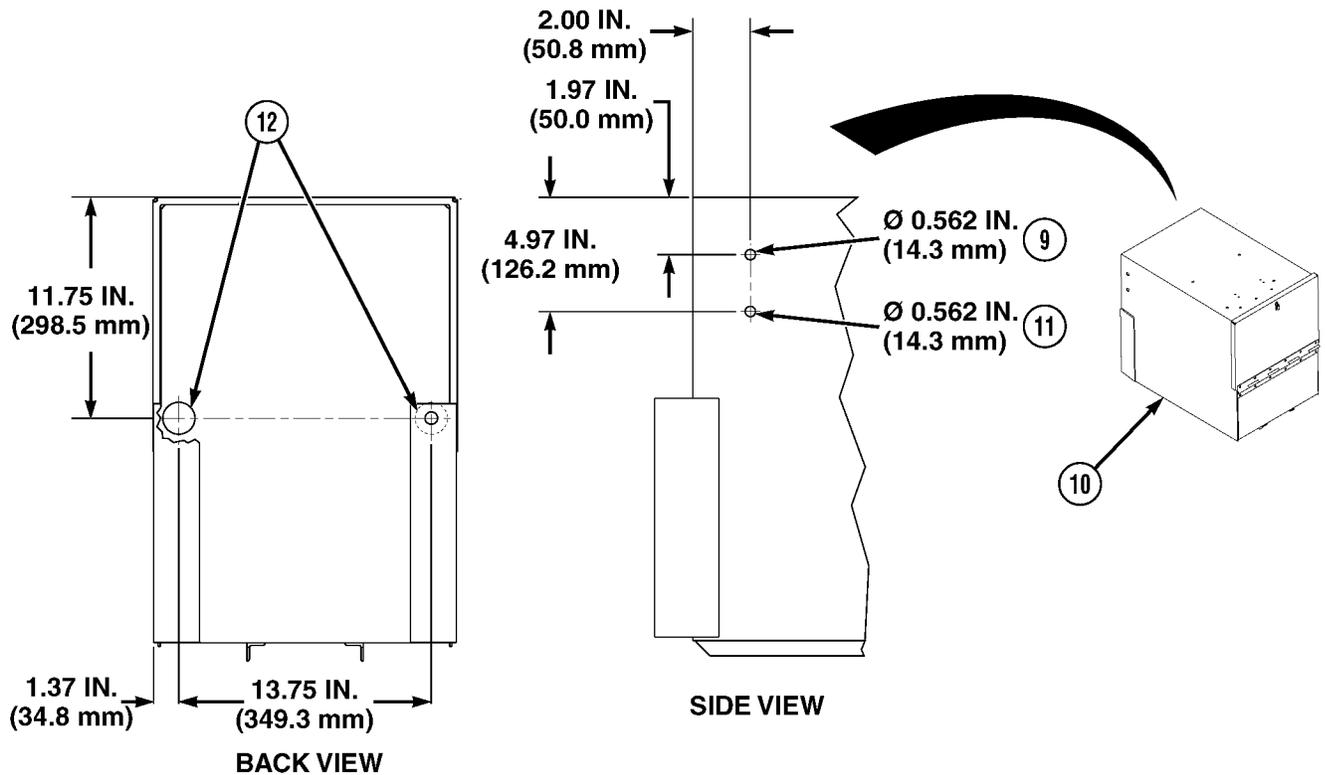

NOTE

Right side shown. Left side drilled the same as right side.

- (7) Drill one 0.562-in. (14.3 mm) hole (9) 1.97 in. (50 mm) down from top and 2 in. (50.8 mm) in from back on right side of stowage box (10).
- (8) Drill one 0.562-in. (14.3 mm) hole (11) 4.97 in. (126.2 mm) down from top and 2 in. (50.8 mm) in from back on right side of stowage box (10).
- (9) Repeat steps (7) and (8) for left side of stowage box.

NOTE

Enlarge screw holes in rear panel of stowage box only. Do not enlarge holes through rear stowage box lower reinforcement.

- (10) Ream two existing holes (12) in rear panel of stowage box to 1.75 in. (44.5 mm).

Direct Support and General Support Maintenance (Cont)

5-43. CONTAINER HANDLING UNIT (CHU) KIT INSTALLATION (CONT).

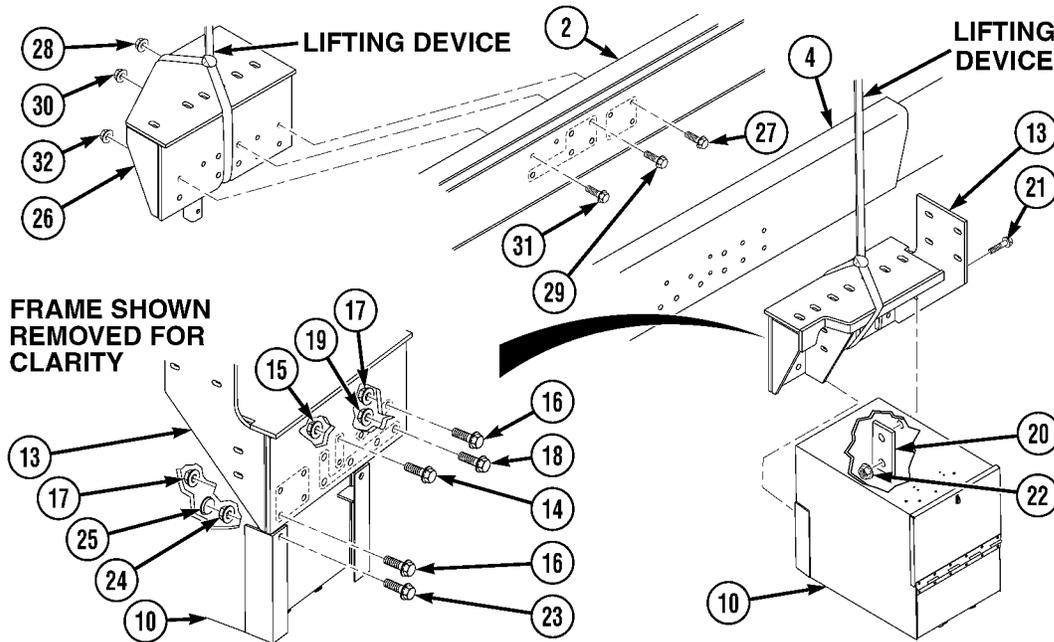

WARNING

Left front support bracket weighs 98 lbs. (44 kg). Attach lifting device to prevent possible injury to personnel.

- (11) Attach lifting device to left front support bracket (13).
- (12) Position left front support bracket (13) and stowage box (10) on left-side frame rail (4).

NOTE

Do not tighten any screws until all screws are installed.

- (13) Install two screws (14), two nuts (15), six screws (16), six nuts (17), five screws (18), five nuts (19), two plates (20), four screws (21), four nuts (22), two screws (23), and two nuts (24). Tighten screws.
- (14) Install two plugs (25).
- (15) Remove lifting device from left front support bracket (13).

WARNING

Right front support bracket weighs 98 lbs. (44 kg). Attach lifting device to prevent possible injury to personnel.

- (16) Attach suitable lifting device to right front support bracket (26).
- (17) Position right front support bracket (26) on right-side frame rail (2).

NOTE

Do not tighten any screws until all screws are installed.

- (18) Install four screws (27), four nuts (28), five screws (29), five nuts (30), screw (31), and nut (22). Tighten all screws.
- (19) Remove lifting device from right front support bracket (26).

Direct Support and General Support Maintenance (Cont)

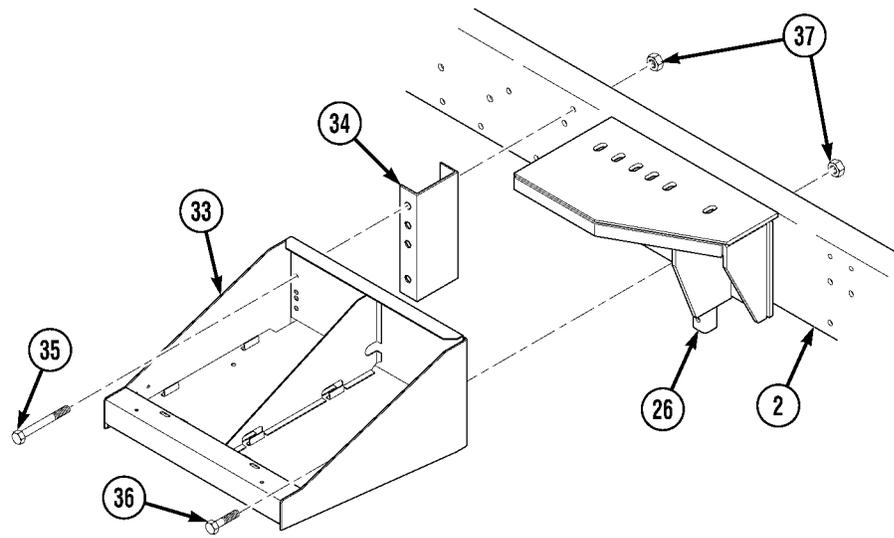

- (20) Install battery box (33) and spacer bracket (34) against right front support bracket (26) and right-side frame rail (2).
- (21) Install four screws (35), five screws (36) and locknuts (37) in back of battery box (33) through spacer bracket (34), right front support bracket (26), and right-side frame rail (2).

Direct Support and General Support Maintenance (Cont)

5-43. CONTAINER HANDLING UNIT (CHU) KIT INSTALLATION (CONT).

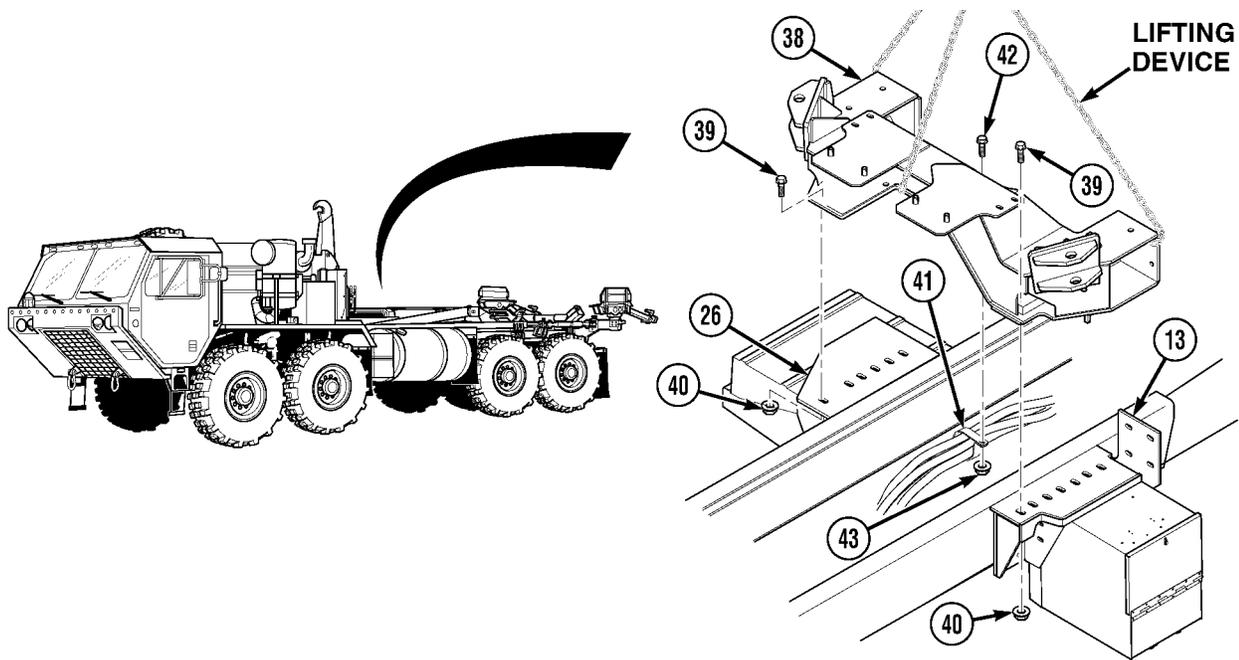

WARNING

Crossmember assembly weighs 530 lbs. (240 kg). Attach lifting device to prevent possible injury to personnel

- (22) Attach lifting device to front crossmember assembly (38).
- (23) Soldier A and Soldier B position front crossmember assembly (38) on left front support bracket (13) and right front support bracket (26).
- (24) Install front crossmember assembly (38) to front support brackets (13) and (26) with 18 screws (39) and locknuts (40).
- (25) Remove lifting device from front crossmember assembly (38).
- (26) Install cushion clip (41), screw (42), and locknut (43). Tighten locknut.

Direct Support and General Support Maintenance (Cont)

WARNING

Stowage tray weigh 72 lbs. (33 kg). Attach lifting device to prevent possible injury to personnel

- (27) Attach suitable lifting device to stowage tray (44).
- (28) While Soldier B controls lifting device, Soldier A positions stowage tray (44) on front CHU support crossmember (38).
- (29) Install four screws (45) and locknuts (46) on stowage tray (44) and front CHU support crossmember (38). Tighten locknuts.
- (30) Remove lifting device from stowage tray (44).

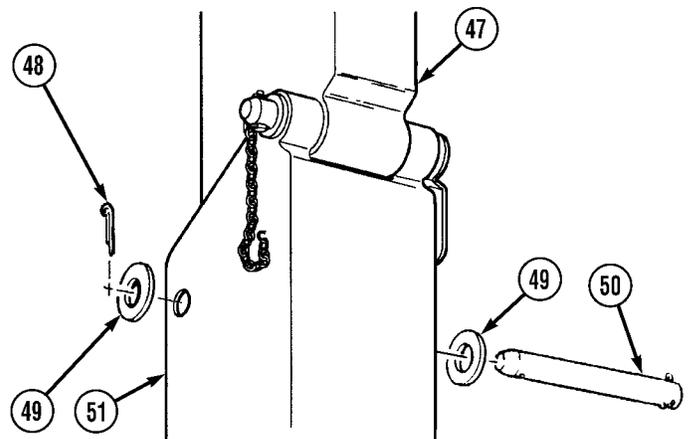
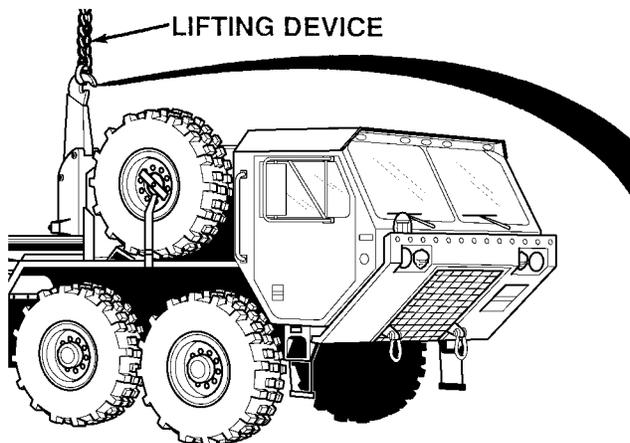
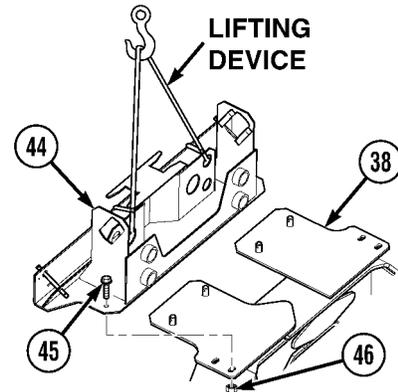

WARNING

Lift hook weighs 200 lbs. (91 kg). Attach suitable lifting device prior to installation to prevent possible injury to personnel.

- (31) Attach lifting device to lift hook (47).
- (32) Remove cotter pin (48), two washers (49), and pivot pin (50) from hook arm (51). Discard cotter pin.

Direct Support and General Support Maintenance (Cont)

5-43. CONTAINER HANDLING UNIT (CHU) KIT INSTALLATION (CONT).

WARNING

Adhesives, solvents, and sealing compounds can burn easily, can give off harmful vapors, and are harmful to skin and clothing. To avoid injury or death, keep away from open fire and use in a well-ventilated area. If adhesive, solvent, or sealing compound gets on skin or clothing, wash immediately with soap and water.

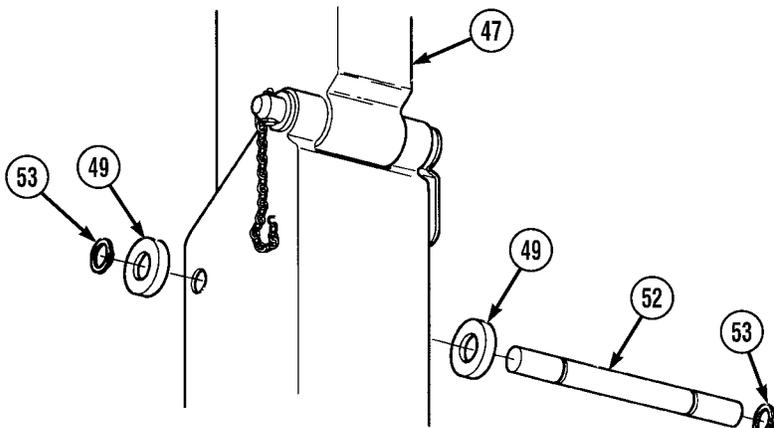

- (33) Apply antiseize compound to CHU pivot pin (52).
- (34) Install CHU pivot pin (52), two washers (49), and two snap rings (53).
- (35) Remove lifting device from lift hook (47).

WARNING

Adhesives, solvents, and sealing compounds can burn easily, can give off harmful vapors, and are harmful to skin and clothing. To avoid injury or death, keep away from open fire and use in well-ventilated area. If adhesive, solvent, or sealing compound gets on skin or clothing, wash immediately with soap and water.

- (36) Apply sealing compound to threads of screw (54).
- (37) Install screw (54) and axle stop (55) on rear guide (56).

WARNING

Rear guide assembly weighs 70 lbs. (32 kg). Attach lifting device to prevent possible injury to personnel.

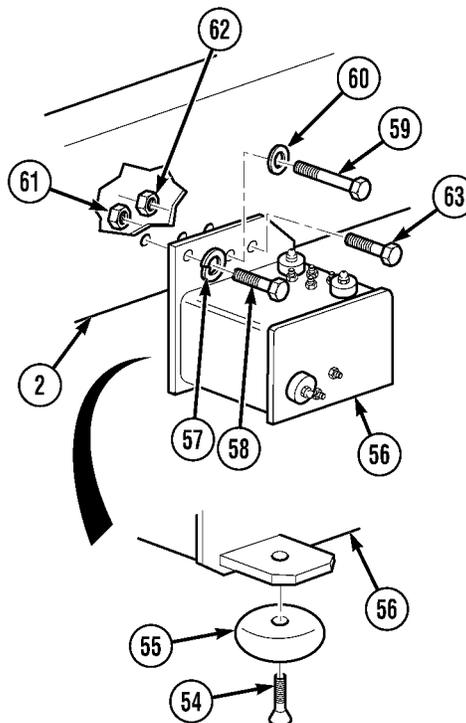

- (38) Attach lifting device to rear guide (56).
- (39) Soldier A position rear guide (56) on right-side frame rail (2). Soldier B install two lockwashers (57) and screws (58).
- (40) Install screw (59), washer (60), and locknut (61) on rear guide (56).
- (41) Install four locknuts (62) and screws (63) on rear guide (56). Tighten screws.
- (42) Remove lifting device from rear guide (56).

Direct Support and General Support Maintenance (Cont)

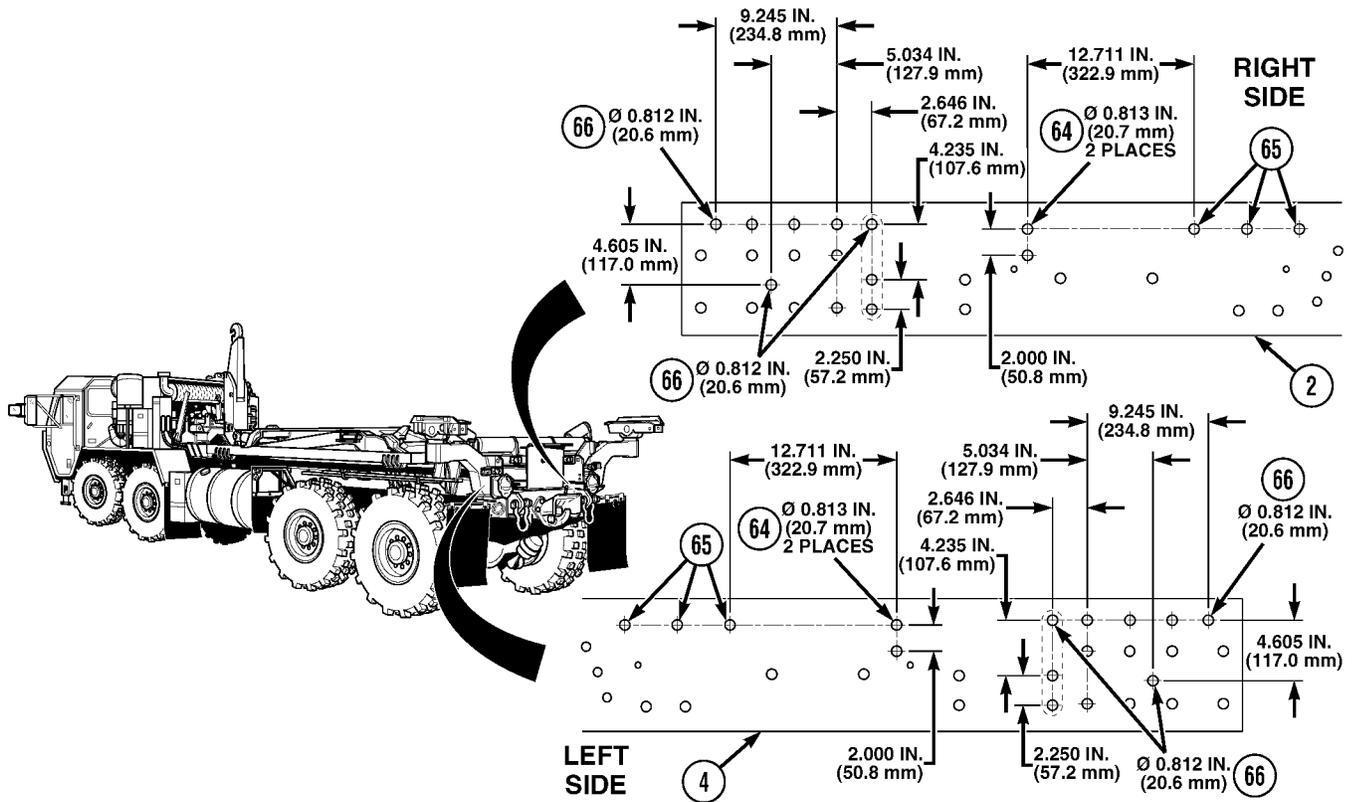

- (43) Measure and mark seven new screw hole positions on right-side frame rail (2) and left-side frame rail (4).
- (44) Drill two 0.813-in. (20.7 mm) holes (64) on each rail near existing holes (65) as shown.
- (45) Drill three 0.812-in. (20.6 mm) holes (66) near end of frame rails (2) and (4) as shown.

Direct Support and General Support Maintenance (Cont)

5-43. CONTAINER HANDLING UNIT (CHU) KIT INSTALLATION (CONT).

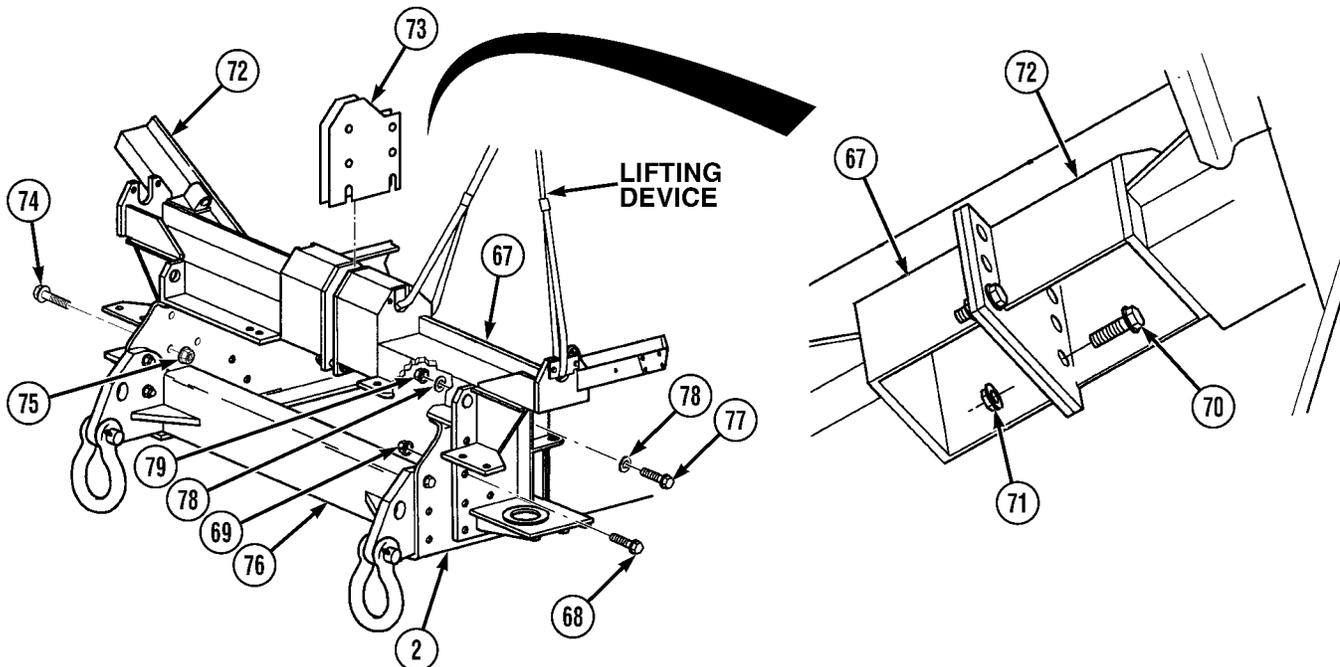

WARNING

Rear roller bracket weighs 150 lbs. (68 kg). Attach suitable lifting device to prevent possible injury to personnel.

- (46) Attach lifting device to rear roller bracket (67).
- (47) Soldier A position rear roller bracket (67) on right-side frame rail (2) and Soldier B secure with five screws (68) and locknuts (69). Do not tighten screws.
- (48) Position bottom two screws (70) and locknuts (71) at center split of right rear roller bracket (67) and left rear roller bracket (72) to maintain alinement.

NOTE

Shims are 1/16 in. (1.59 mm) thick. Add one shim per every 1/16-in. (1.59 mm) gap.

- (49) Measure gap at center split and determine number of shims (73) required.
- (50) Position shim(s) (73), if required, in center split and install remaining four screws (70) and locknuts (71).
- (51) Soldier A and Soldier B position five screws (74) and locknuts (75) on rear roller bracket (72), right-side frame rail (2), and rear crossmember (76).

NOTE

Perform step (52) for right side only.

- (52) Install screw (77), two washers (78), and locknut (79) on rear roller bracket (67).

Direct Support and General Support Maintenance (Cont)

NOTE

- Right and left rear mounting brackets are installed the same way. Right side shown.
- Right and left composite light brackets are installed the same way. Right side shown.

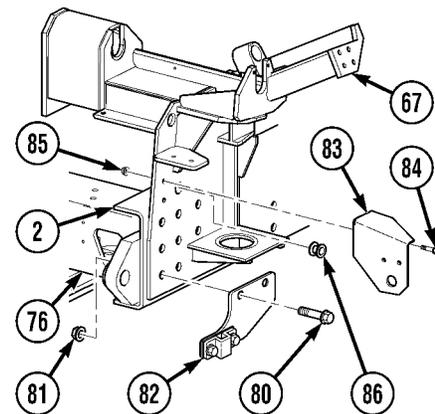

- (53) Install two screws (80), locknuts (81), and rear mounting bracket (82) on right-side frame rail (2) and rear crossmember (76).
- (54) Repeat step (53) for left side of truck.
- (55) Remove lifting device from rear roller bracket (67).
- (56) Install right composite light bracket (83) on right-side frame rail (2) with two screws (84) and locknuts (85).
- (57) Install rubber grommet (86) in right-side frame rail (2) beside right composite light bracket (83).
- (58) Repeat steps (56) and (60) for left composite light bracket.
- (59) Adjust short strut as shown in **b. Adjustment**.

- (60) Install right long strut support bracket (87) with five screws (88) and nuts (89). Tighten nuts.
- (61) Install left long strut support bracket (90) on left-side frame rail (4) with four screws (91) and nuts (92). Tighten nuts.
- (62) Install rear ladder bracket (93), screw (91), and nut (92). Tighten nuts.
- (63) Install cross support brace (94) on right strut support bracket (87) and left strut support bracket (90) with four screws (95) and nuts (96). Tighten nuts.

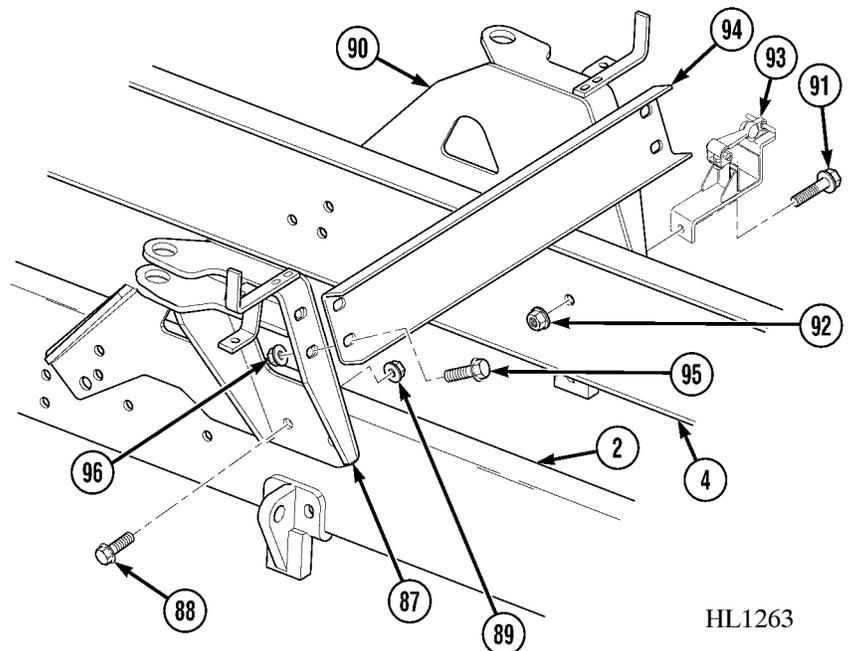

HL1263

Direct Support and General Support Maintenance (Cont)

5-43. CONTAINER HANDLING UNIT (CHU) KIT INSTALLATION (CONT).

WARNING

Use care when installing snap rings and retaining rings. Snap rings and retaining rings are under spring tension and can act as projectiles when released and can cause severe injury.

NOTE

Beveled edge of spacer faces bearing in long strut.

- (64) Install long strut (97) and spacer (98) in bracket assembly (87) with pin (99) and retaining ring (100).
- (65) Install wire rope (101) through swage sleeve (102), pin (103), and back into swage sleeve.
- (66) Install wire rope (101) through swage sleeve (104), cotter pin (105) and back into swage sleeve (104).
- (67) Install cushion clip (106) on wire rope (101).
- (68) Install cushion clip (106) on long strut (97) with screw (107).

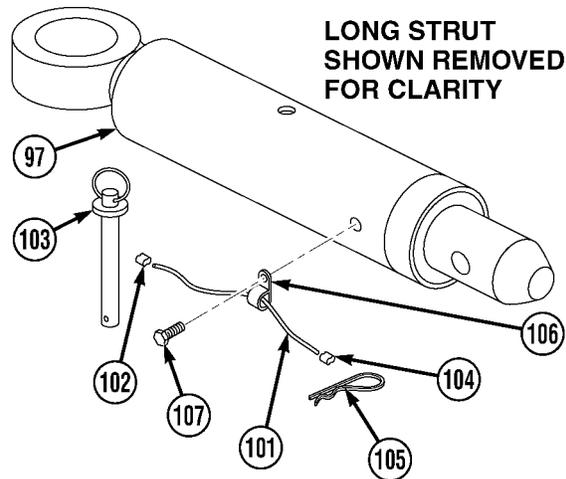
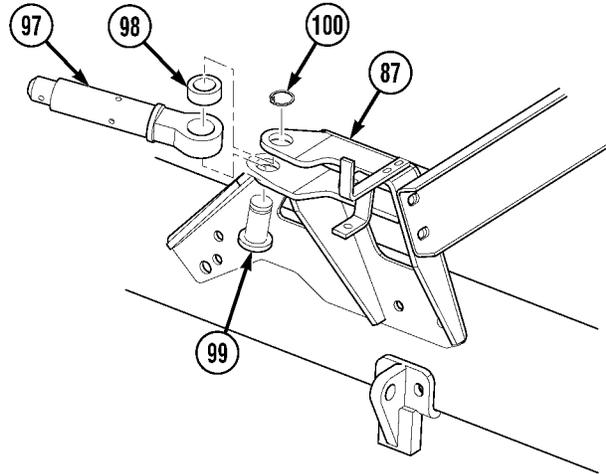

Direct Support and General Support Maintenance (Cont)

NOTE

- Right and left arm assemblies are installed the same. Right side is shown.
 - Shim is 0.06 in. (1.5 mm) thick. Add one shim per every gap between retaining ring and bottom edge of roller bracket.
 - Only add shim(s) if gap between retaining ring and bottom edge of roller bracket exceeds 0.06 in. (1.5 mm).
- (69) Install pivot pin (108) and retaining ring (109).
 - (70) Measure distance between retaining ring (108) and roller bracket (67).
 - (71) Determine amount of shim(s) (110) required and remove retaining ring (109) and pivot pin (108) from roller bracket (67).

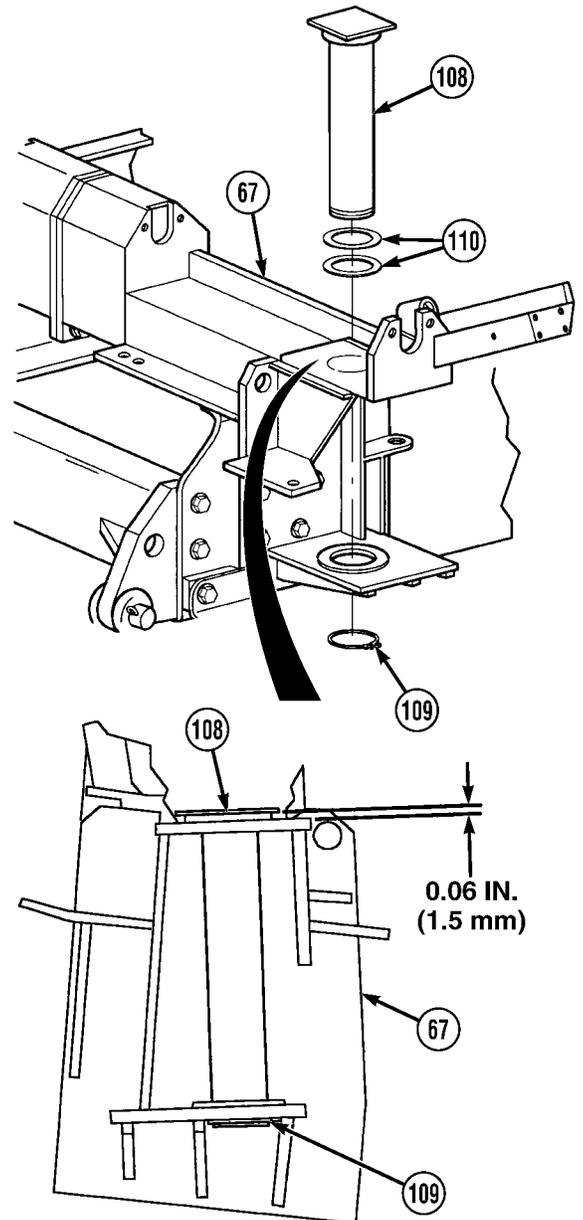

Direct Support and General Support Maintenance (Cont)

5-43. CONTAINER HANDLING UNIT (CHU) KIT INSTALLATION (CONT).

- (72) Apply grease to face of thrust washer (111), seal (112), bore in arm assembly (113), and bores and thrust face of rear roller bracket (67).

WARNING

Arm assembly weighs 240 lbs. (109 kg). Attach suitable lifting device to prevent possible injury to personnel.

- (73) Attach lifting device to arm assembly (113).

CAUTION

Make sure not to damage bottom of preformed packing during arm installation.

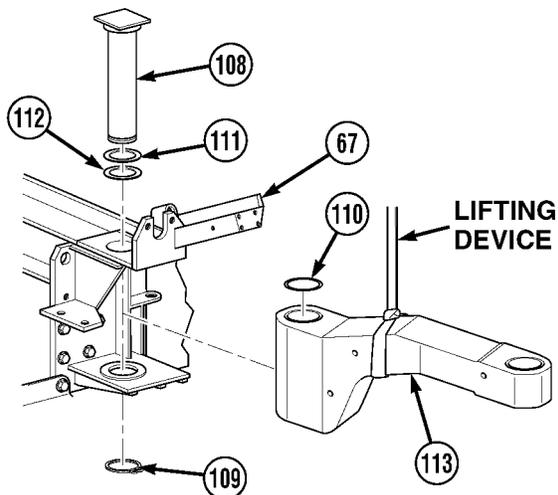

- (74) Soldier A position large end of arm assembly (113) in rear roller bracket (67).

WARNING

Use care when installing snap rings and retaining rings. Snap rings and retaining rings are under spring tension and can act as projectiles when released and can cause severe injury.

- (75) Soldier B apply grease to outer surface of pivot pin (108) and install pivot pin, shim(s) (110), if required, and retaining ring (109) in arm assembly (113) and rear roller bracket (67).
- (76) Remove lifting device from arm assembly (113).

WARNING

Adhesives, solvents, and sealing compounds can burn easily, can give off harmful vapors, and are harmful to skin and clothing. To avoid injury or death, keep away from open fire and use in well-ventilated area. If adhesive, solvent, or sealing compound gets on skin or clothing, wash immediately with soap and water.

NOTE

Right and left arm assemblies are installed the same. Right side is shown.

- (77) Apply sealing compound (Loctite 242) to threads of four screws (114).
- (78) Install four screws (114) and handle (115) on right arm assembly (113).

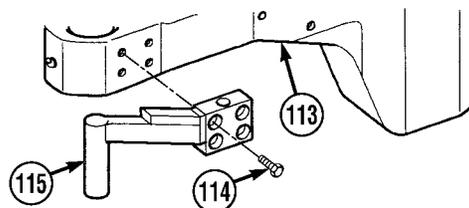

Direct Support and General Support Maintenance (Cont)

WARNING

Adhesives, solvents, and sealing compounds can burn easily, can give off harmful vapors, and are harmful to skin and clothing. To avoid injury or death, keep away from open fire and use in well-ventilated area. If adhesive, solvent, or sealing compound gets on skin or clothing, wash immediately with soap and water.

NOTE

There are two pin bracket assemblies. Both are installed the same way. Right side is shown.

- (79) Apply sealing compound to threads of four screws (116).
- (80) Install four screws (116) and pin bracket (117) on arm assembly (113).

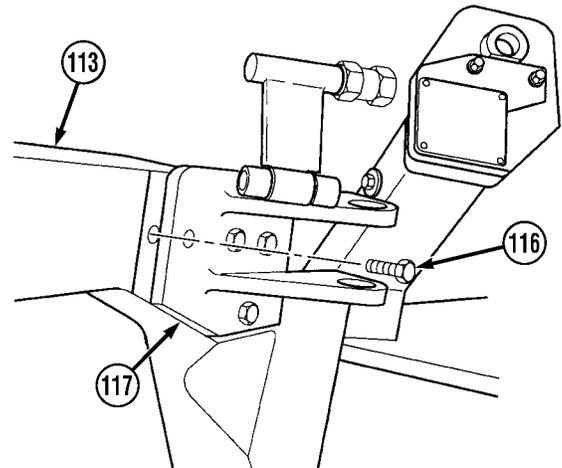

WARNING

Use care when installing snap rings and retaining rings. Snap rings and retaining rings are under spring tension and can act as projectiles when released and can cause severe injury.

NOTE

Beveled edge of spacer faces bearing in short strut.

- (81) Install spacer (118), short strut (119), pivot pin (120), and retaining ring (121) on pin bracket (117).

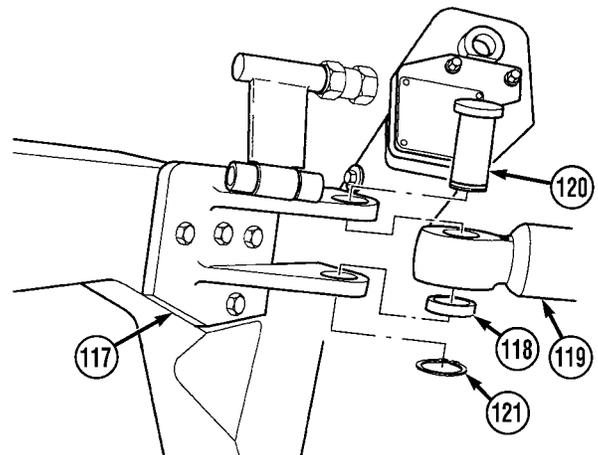

Direct Support and General Support Maintenance (Cont)

5-43. CONTAINER HANDLING UNIT (CHU) KIT INSTALLATION (CONT).

WARNING

Adhesives, solvents, and sealing compounds can burn easily, can give off harmful vapors, and are harmful to skin and clothing. To avoid injury or death, keep away from open fire and use in well-ventilated area. If adhesive, solvent, or sealing compound gets on skin or clothing, wash immediately with soap and water.

- (82) Apply sealing compound (Loctite 242) to threads of screw (122).
- (83) Position screw (123), washer (124), and loop end of wire rope (124) on right rear roller bracket (67). Do not tighten screw.

WARNING

Adhesives, solvents, and sealing compounds can burn easily, can give off harmful vapors, and are harmful to skin and clothing. To avoid injury or death, keep away from open fire and use in well-ventilated area. If adhesive, solvent, or sealing compound gets on skin or clothing, wash immediately with soap and water.

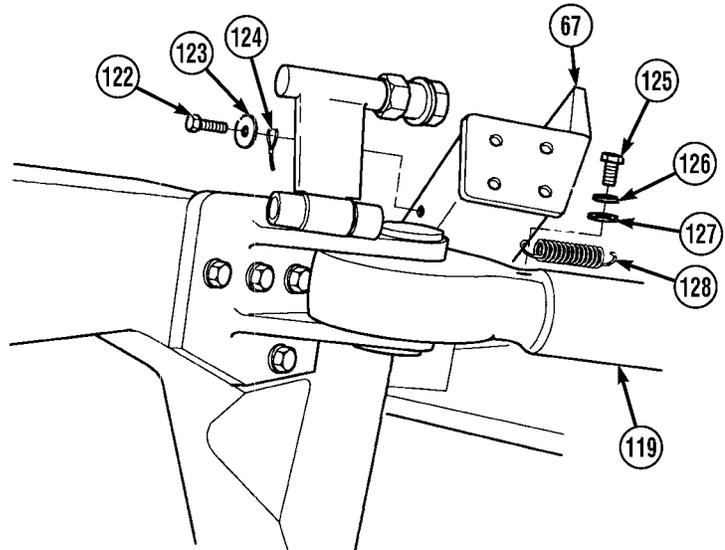

- (84) Apply sealing compound (Loctite 242) to threads of screw (125).

NOTE

Screw is properly installed when head of screw is 0.50 in. (12.7 mm) from surface of short strut.

- (85) Install screw (125), washer (126), washer (127), and spring (128) on short strut (119).
- (86) Soldier A support slider arm (113) and Soldier B position short strut (119) in long strut (97) and install pin (103) and quick release pin (105).
- (87) Position wire rope (124) through end loop of spring (128).

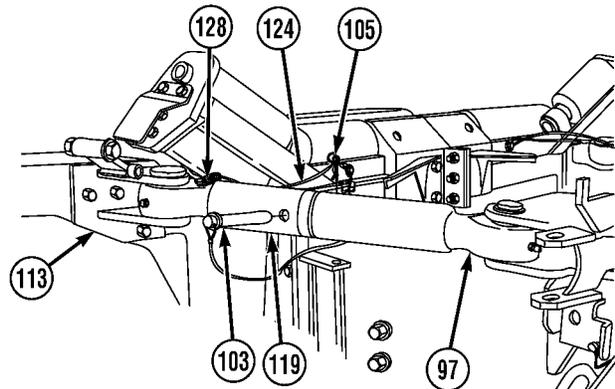

Direct Support and General Support Maintenance (Cont)

WARNING

Adhesives, solvents, and sealing compounds can burn easily, can give off harmful vapors, and are harmful to skin and clothing. To avoid injury or death, keep away from open fire and use in well-ventilated area. If adhesive, solvent, or sealing compound gets on skin or clothing, wash immediately with soap and water.

- (88) Apply sealing compound (Loctite 242) to threads of screw (129).
- (89) Position screw (129), washer (130), and end of wire (124) on right rear roller bracket (67).

NOTE

Wire must be pulled tight against roller bracket when installed.

- (90) Wrap wire (124) around screw (129) and under washer (130) and tighten screws (129) and (122) on right rear roller bracket (67).

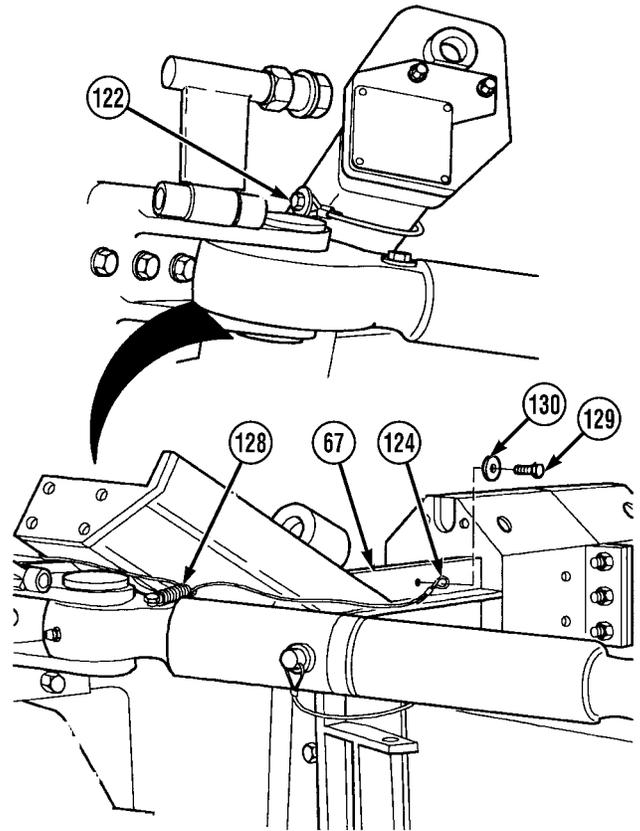
**NOTE**

Sealing compound is applied to metallic side of thrust washer.

- (91) Apply sealing compound (Loctite 680) supplied in kit to thrust washer (131).
- (92) Apply adhesive (Loctite 409) supplied in kit to six points in recessed groove for preformed packing (132).

NOTE

Thrust washer is properly installed with metallic side to arm.

- (93) Install seal (133), preformed packing (132), and thrust washer (131) on arm assembly (113).

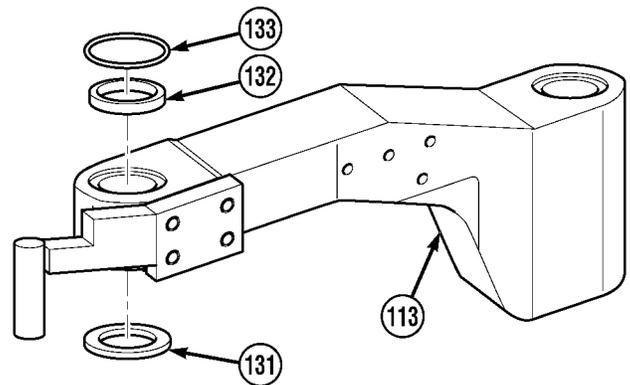

Direct Support and General Support Maintenance (Cont)

5-43. CONTAINER HANDLING UNIT (CHU) KIT INSTALLATION (CONT).

WARNING

- Drycleaning solvent (P-D-680) is TOXIC and flammable. Wear protective goggles, face shield, and gloves; use only in a well-ventilated area; avoid contact with skin, eyes, and clothes; and do not breathe vapors. Keep away from heat or flame. Never smoke when using solvent. The flashpoint for Type III Drycleaning Solvent is 200° F (93° C). Failure to do so may result in injury or death to personnel.
- If personnel becomes dizzy while using cleaning solvent, immediately get fresh air and medical help. If solvent contacts skin or clothes, flush with cold water. If solvent contacts eyes, immediately flush eyes with water and get immediate medical attention.

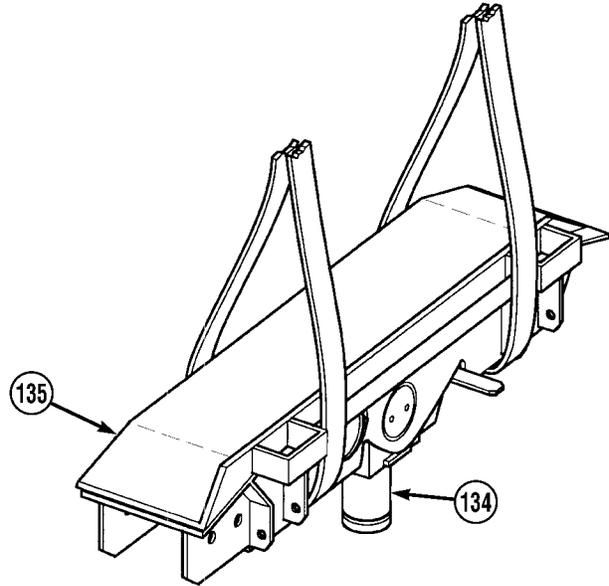

- (94) Clean preservative from slider pivot pin (134) with drycleaning solvent.

WARNING

Slider weighs 142 lbs. (64 kg). Attach suitable lifting device to prevent possible injury to personnel.

- (95) Attach lifting device to slider assembly (135).
- (96) Apply light coat of grease to outer surface of slider pivot pin (134), washer (136), and retaining ring (137).

NOTE

Make sure retaining ring is fully seated in step (97).

- (97) Soldier A position slider pivot pin (134) in arm assembly (113) and Soldier B install washer (136) and retaining ring (137).
- (98) Remove lifting device from slider assembly (135).
- (99) Check that pivot lock pin (138) properly locks into handle (115).

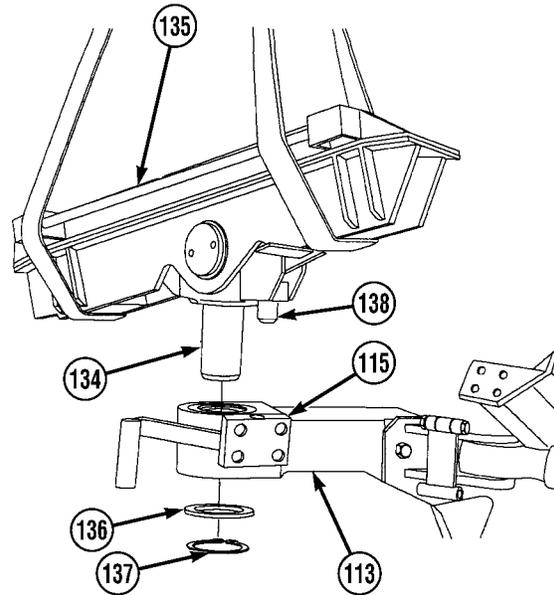

Direct Support and General Support Maintenance (Cont)

NOTE

Right and left stow plates are installed the same. Right side is shown.

- (100) Position stow plate (139) on right rear roller bracket (67) with two screws (140) and locknuts (141). Do not tighten screws.

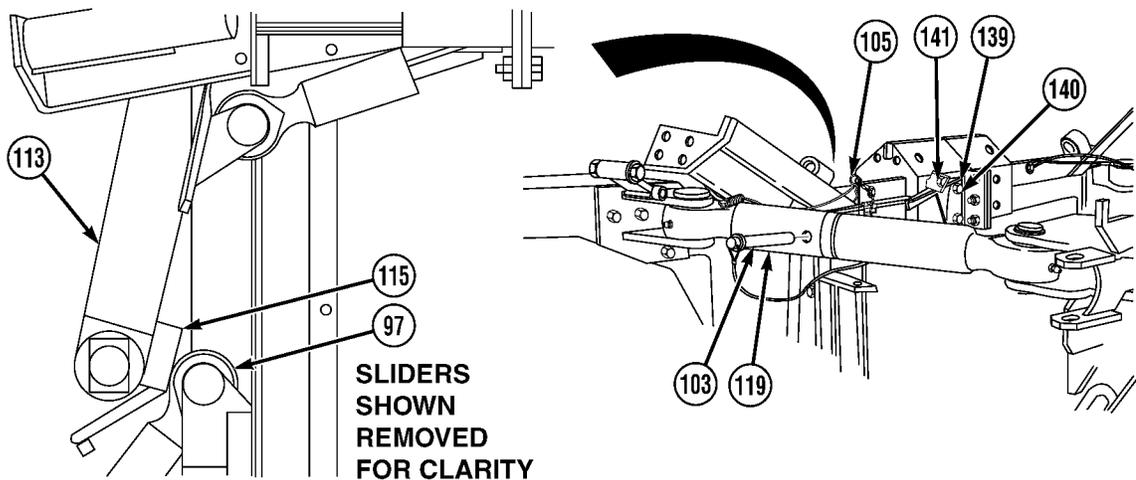
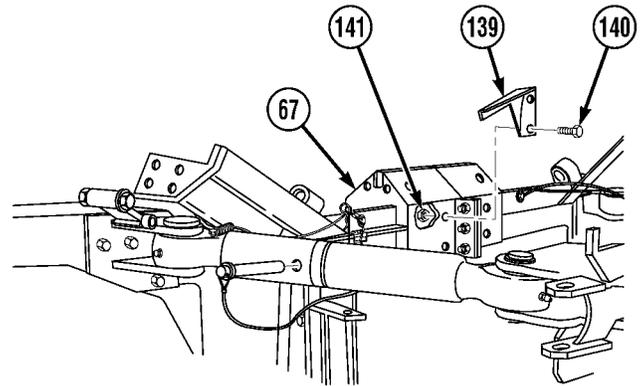

- (101) Remove quick release pin (105) and pin (103) from short strut (119).

NOTE

- Stow plate should be positioned in center of short strut.
- Make sure slider arm is fully stowed and slider arm handle contacts long strut prior to tightening two screws.

- (102) Position short strut (119) on stow plate (139) in stowed position and make sure handle (115) of arm assembly (113) contacts long strut (97).
- (103) Tighten two screws (140) and locknuts (141) on stow plate (139).
- (104) Push down handle (115) and stow arm assembly (113) in forward position.

Direct Support and General Support Maintenance (Cont)

5-43. CONTAINER HANDLING UNIT (CHU) KIT INSTALLATION (CONT).

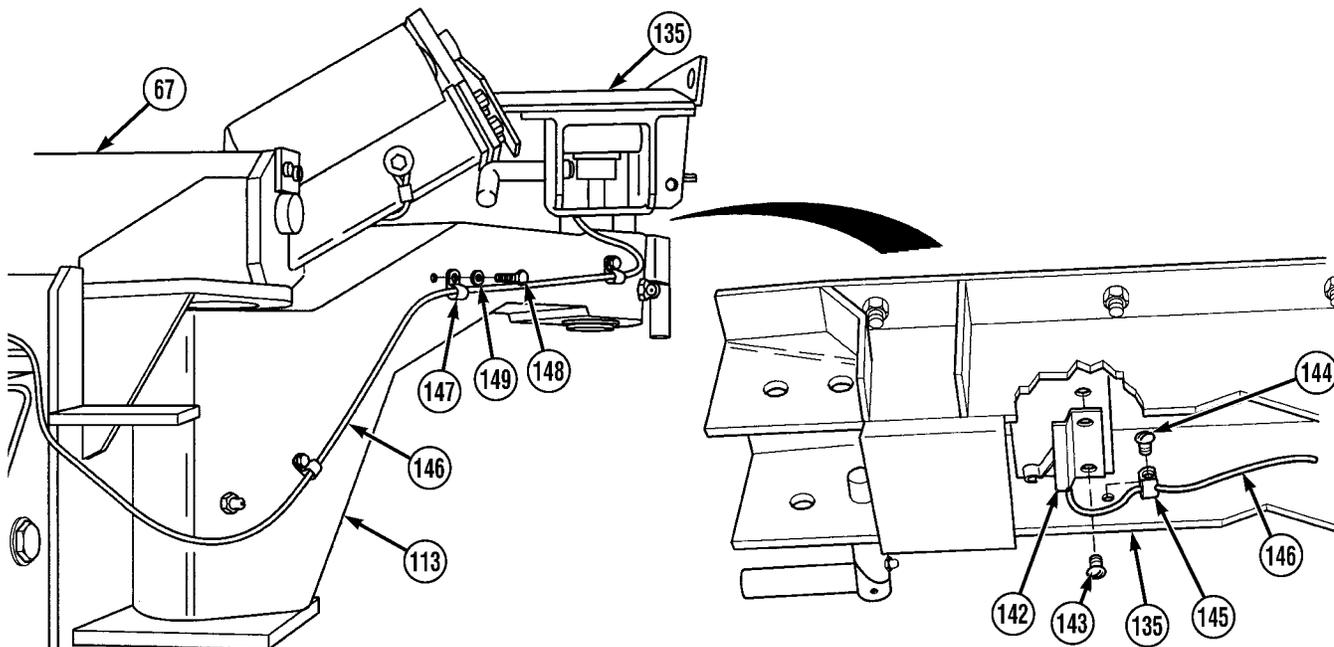

NOTE

- Left and right lock limit switches are identical. Right lock limit switch is shown.
- Install cable ties as required.

(105) Position right lock limit switch (142) with two screws (143) on slider (135). Do not tighten screws.

WARNING

Adhesives, solvents, and sealing compounds can burn easily, can give off harmful vapors, and are harmful to skin and clothing. To avoid injury or death, keep away from open fire and use in well-ventilated area. If adhesive, solvent, or sealing compound gets on skin or clothing, wash immediately with soap and water.

- (106) Apply sealing compound to threads of screw (144).
- (107) Position cushion clip (145) on CHU wire harness (146) and install on slider (135) with screw (144).
- (108) Stow right slider (Para 2-10.6).
- (109) Position CHU wire harness (146) along arm assembly (113) and under rear roller assembly (67).

WARNING

Adhesives, solvents, and sealing compounds can burn easily, can give off harmful vapors, and are harmful to skin and clothing. To avoid injury or death, keep away from open fire and use in well-ventilated area. If adhesive, solvent, or sealing compound gets on skin or clothing, wash immediately with soap and water.

- (110) Apply sealing compound to threads of three screws (148).

CAUTION

Leave enough slack in wire harness around pivot assembly to rotate slider without causing damage to harness.

- (111) Position three cushion clips (147) on CHU wire harness (146) and install on arm assembly (113) with three screws (148) and washers (149).

Direct Support and General Support Maintenance (Cont)

NOTE

Reflectors are located on removed roller bracket.

- (112) Remove two self-tapping screws (150), reflector housing (151), and reflector (152) from LHS roller bracket (153). Discard self-tapping screws.

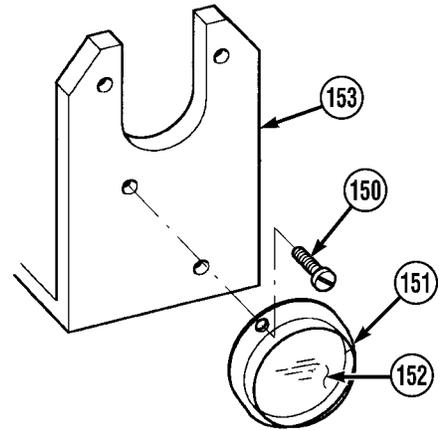

- (113) Using two self-tapping screws (154), install reflector (152) and reflector housing (151) on slider (135).
- (114) Repeat steps (112) and (113) for left side of truck.

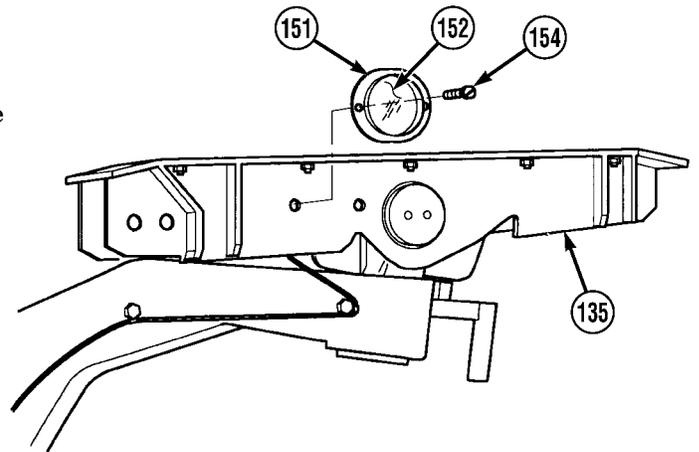

Direct Support and General Support Maintenance (Cont)

5-43. CONTAINER HANDLING UNIT (CHU) KIT INSTALLATION (CONT).

WARNING

Horizontal roller weighs 75 lbs. (34 kg). Attach suitable lifting device prior to installation to prevent possible injury to personnel.

NOTE

- Reuse roller, screw, locknut, and thrust washer from removal of horizontal roller.
- Both rollers are installed the same way. Right side shown.

- (115) Attach lifting device to roller (155).
- (116) With the aid of Soldier B, Soldier A position roller (155) in right rear roller bracket (67).
- (117) Install two screws (156), lockwashers (157), and lockplate (158) in right rear roller bracket (67).

NOTE

Locknut is installed properly when locknut is tightened and roller does not bind.

- (118) Install thrust washer (159), lockwasher (160), and locknut (161) on roller (155).
- (119) Bend tab of lockwasher (160) into slot of locknut (161).
- (120) Remove lifting device from roller (155).
- (121) Repeat steps (115) through (120) for left side of truck.

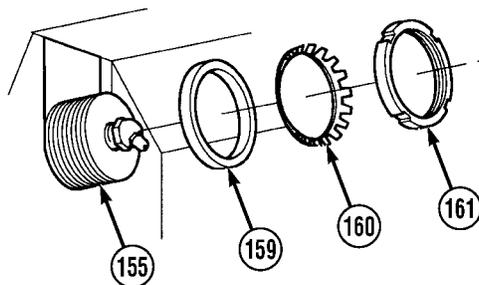
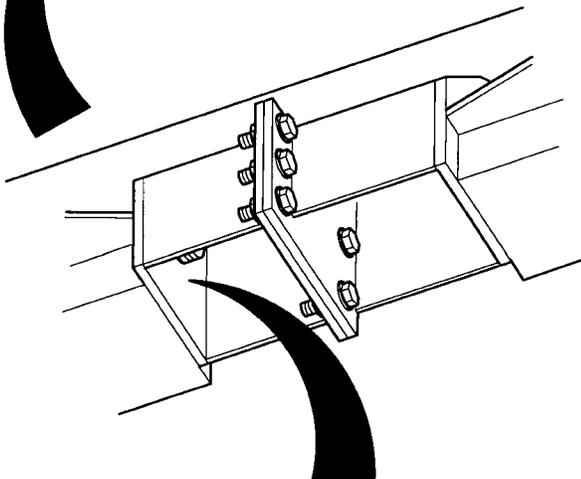
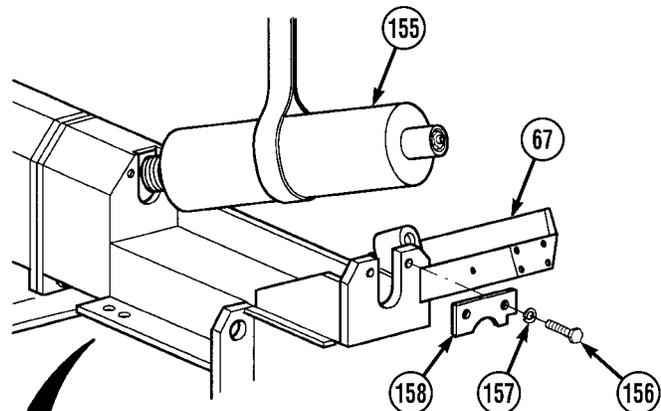

Direct Support and General Support Maintenance (Cont)

NOTE

Reuse roller, lockplate, and screws from removal of angled roller.

(122) Position roller (162) in right rear roller bracket (67).

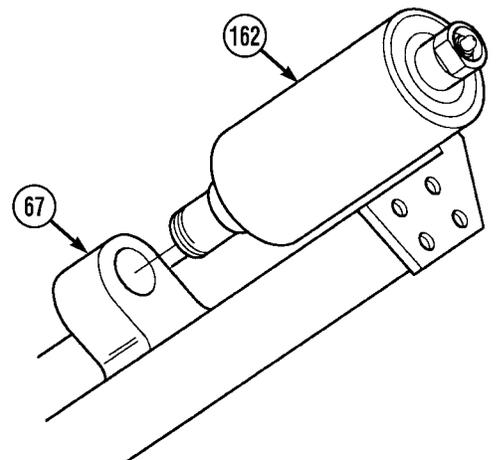

(123) Install endplate (163), four lockwashers (164), and screws (165).

(124) Install lockplate (166), bracket (167), two lockwashers (168), and screws (169) on rear roller bracket (67).

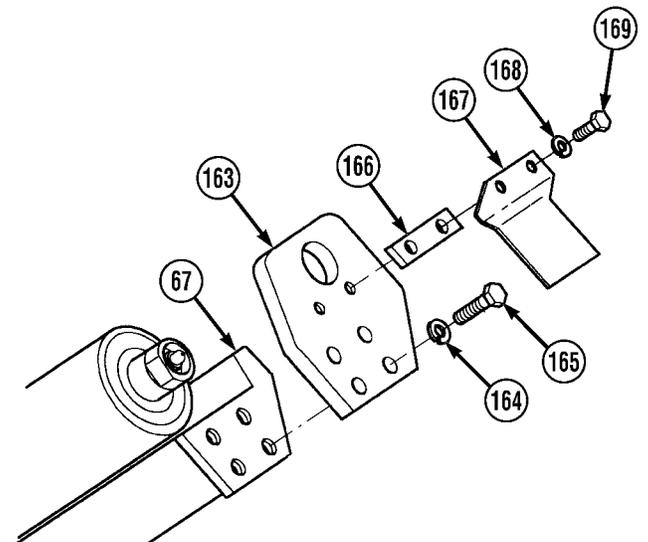

(125) Install lockwasher (170) and locknut (171) on roller (162).

(126) Bend tab of lockwasher (170) into slot of locknut (171).

(127) Repeat steps (122) through (126) for left side of truck.

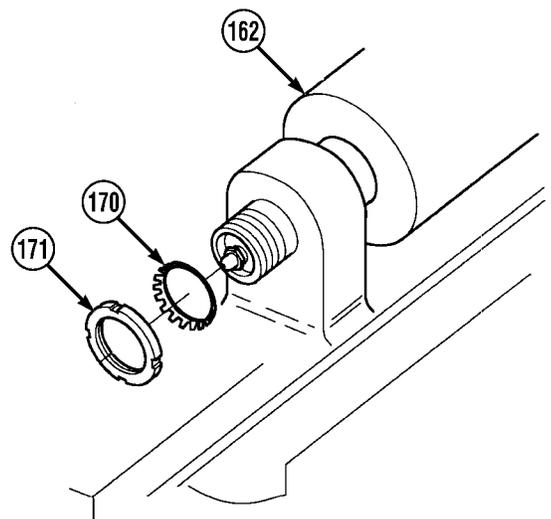

Direct Support and General Support Maintenance (Cont)

5-43. CONTAINER HANDLING UNIT (CHU) KIT INSTALLATION (CONT).

- (128) Install rear light bar (172), two lockwashers (173), and two nuts (174).
- (129) Connect wires to rear light bar (172).

NOTE

Both clearance lights install the same. Right side shown.

- (130) Install clearance light (175), two lockwashers (176), and two nuts (177) to roller bracket assembly (67).
- (131) Connect wires to clearance light (175).

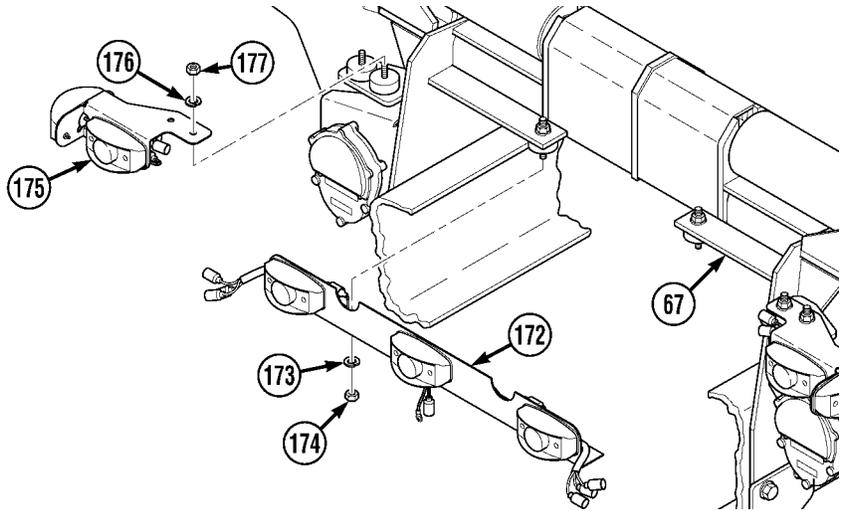

- (132) Connect batteries (TM 9-2320-364-20).
- (133) Start engine (TM 9-2320-364-10).
- (134) Fully extend hook arm (51) to take tension off pivot point (Para 2-9).

WARNING

Hook arm weighs 1,100 lbs. (499 kg). Attach suitable lifting device to prevent possible injury to personnel.

Make sure hook arm is supported with lifting device during installation to prevent possible injury to personnel.

- (135) Attach lifting device to hook arm (51).
- (136) Make sure hook arm (51) is positioned fully to left side of truck. Use a pry bar if needed.

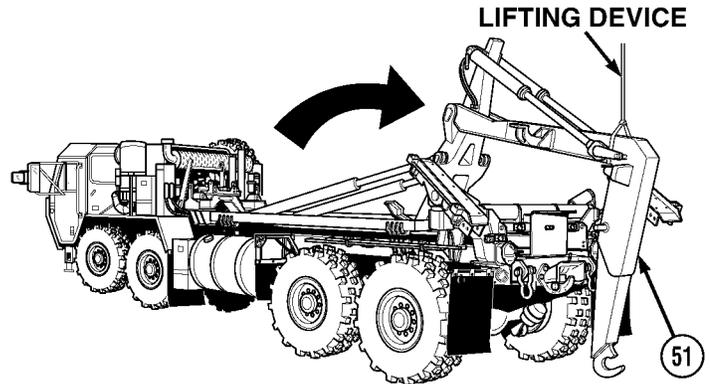

Direct Support and General Support Maintenance (Cont)

WARNING

Use care when removing retaining rings. Retaining rings are under tension and can act as projectiles when released, causing injury to personnel.

NOTE

- Shim is 0.0747 in. (1.9 mm) thick. Add one shim per every 0.0747-in. (1.9 mm) gap between inside lip and hook arm.
- Only add shim if area between inside lip and hook arm exceeds 0.0747 in. (1.9 mm).
- Perform steps (138) through (142) if shim(s) are required.

- (137) Measure distance between hook arm (51) and inside lip of main frame (178). Record as measurement "A."
- (138) Soldier A supports hook arm (51) and Soldier B removes retaining ring (179) from left side of pivot pin (180).

NOTE

Do not completely remove pivot pin.

- (139) Partially remove left-side pivot pin (180) until shim(s) (181) can be installed between hook arm (51) and main frame (178).
- (140) Position shim(s) (181), as required, between inside lip of main frame (178) and hook arm (51).
- (141) Install left-side pivot pin (180) through shim(s) (181) and inside lip of main frame (178).
- (142) Install retaining ring (179).
- (143) Remove lifting device from hook arm (51).

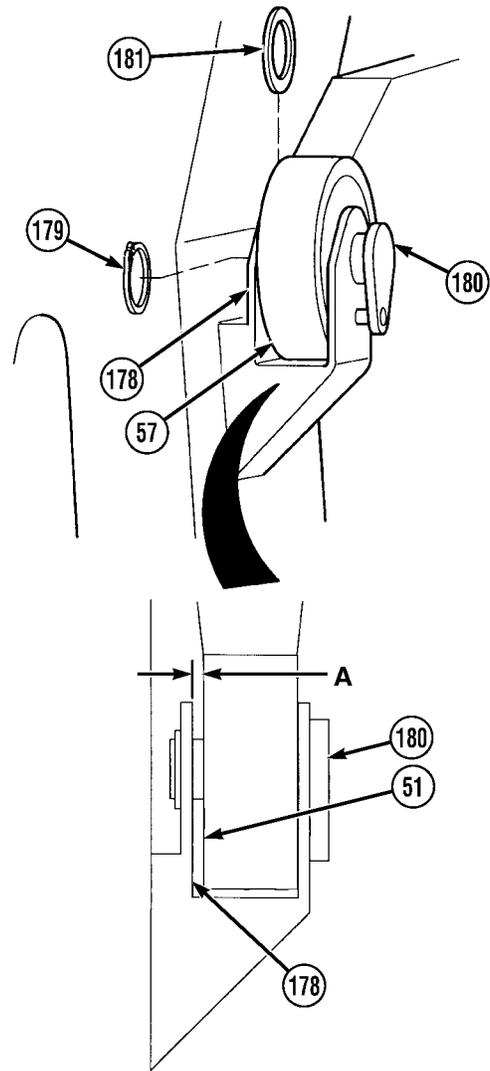

Direct Support and General Support Maintenance (Cont)

5-43. CONTAINER HANDLING UNIT (CHU) KIT INSTALLATION (CONT).

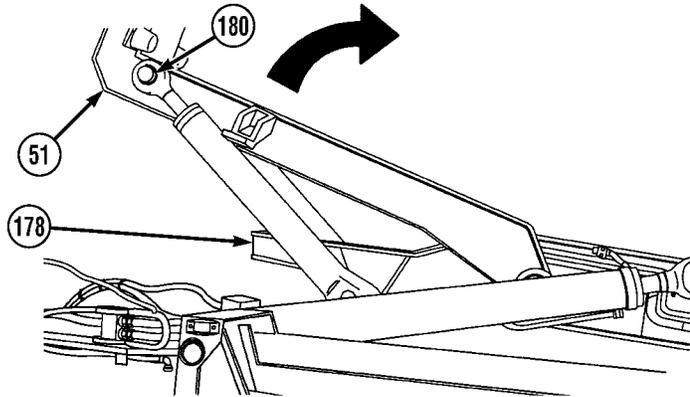
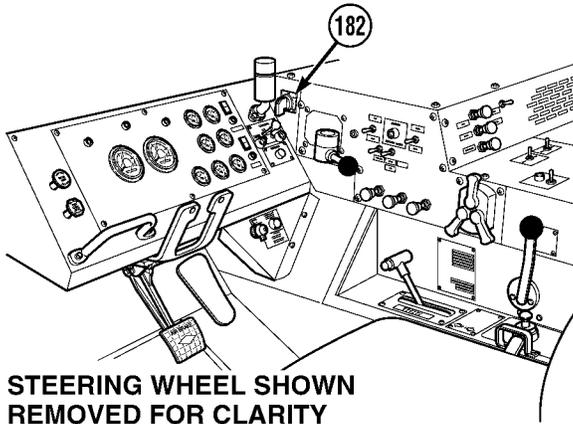

NOTE

LHS is being raised to expose area where sensor plate will be installed.

- (144) Start engine (TM 9-2320-279-10).
- (145) Stow LHS (Para 2-9).

CAUTION

Engine speed must be at idle before using hydraulic selector switch, or damage to equipment may result.

- (146) Set hydraulic selector switch (182) to MAN H.A. position and raise hook arm (51) until hook arm cylinder pivot pin (180) is 25 in. (63.5 cm) from main frame (178).
- (147) Set hydraulic selector switch (182) to MAN M.F. and raise main frame (178) until hook arm cylinder pivot pin (180) is 45 in. (114.3 cm) from main frame (178).
- (148) Shut OFF engine (TM 9-2320-279-10).
- (149) Disconnect batteries (TM 9-2320-279-20).

Direct Support and General Support Maintenance (Cont)

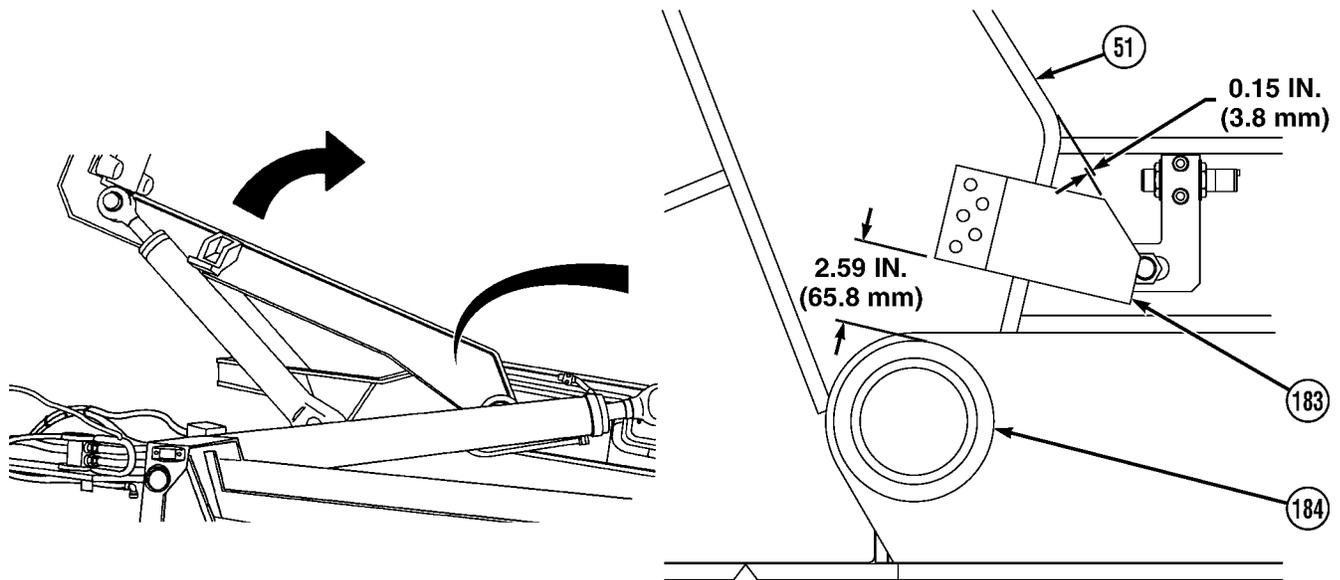
**WARNING**

CARC paint contains isocyanate (HDI), which is highly irritating to skin and respiratory system. High concentrations of HDI can produce symptoms of itching and reddening of skin, a burning sensation in throat and nose, and watering of the eyes. In extreme concentrations, HDI can cause cough, shortness of breath, pain during respiration, increased sputum production, and chest tightness. The following precautions must be taken whenever using CARC paint:

- ALWAYS use air line respirators when using CARC paint unless air sampling shows exposure to be below standards. Use chemical cartridge respirator if air sampling is below standards.
- DO NOT let skin or eyes come in contact with CARC paint. Always wear protective equipment (gloves, ventilation mask, safety goggles, etc.).
- DO NOT use CARC paint without adequate ventilation.
- NEVER weld or cut CARC-coated materials.
- DO NOT grind or sand painted equipment without high-efficiency, air-purifying respirators in use.
- BE AWARE of CARC paint exposure symptoms; symptoms can occur a few days after initial exposure. Seek medical help immediately if symptoms are detected.

(150) Measure and mark an area on hook arm (51) for sensor plate (183) to be mounted as shown.

(151) Grind off paint in area marked in step (150) for sensor plate (183) to be mounted.

(152) Mark hook arm (51) 2.59 in. (65.8 mm) from boss (184) on hook arm.

(153) Aline sensor plate (183) 0.15 in. (3.8 mm) below top edge of hook arm (51).

Direct Support and General Support Maintenance (Cont)

5-43. CONTAINER HANDLING UNIT (CHU) KIT INSTALLATION (CONT).

- (154) Position sensor plate (183) with two clamps on hook arm (51) as shown.
- (155) Mark line around sensor plate (183) on hook arm (51).
- (156) Remove two clamps and sensor plate (183) from hook arm (51).

WARNING

Adhesives, solvents, and sealing compounds can burn easily, can give off harmful vapors, and are harmful to skin and clothing. To avoid injury or death, keep away from open fire and use in well-ventilated area. If adhesive, solvent, or sealing compound gets on skin or clothing, wash immediately with soap and water.

NOTE

Mix epoxy according to directions on package.

- (157) Mix epoxy supplied with CHU kit and apply to sensor plate (183) and hook arm (51).

NOTE

Epoxy takes approximately 15 minutes to cure.

- (158) Clamp sensor plate (183) to hook arm (51) in position marked until cured.
- (159) Remove clamps from hook arm (51).
- (160) Prime and paint area as necessary (TM 43-0139).

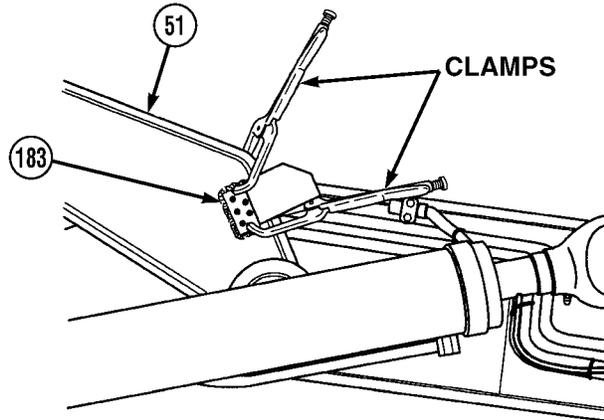

Direct Support and General Support Maintenance (Cont)

- (161) Remove two screws (185), lockwashers (186), and plate (187) from two clamp halves (188). Discard lockwashers and plate.
- (162) Install two screws (185), lockwashers (186), and proximity switch mount (189) on two clamp halves (188).

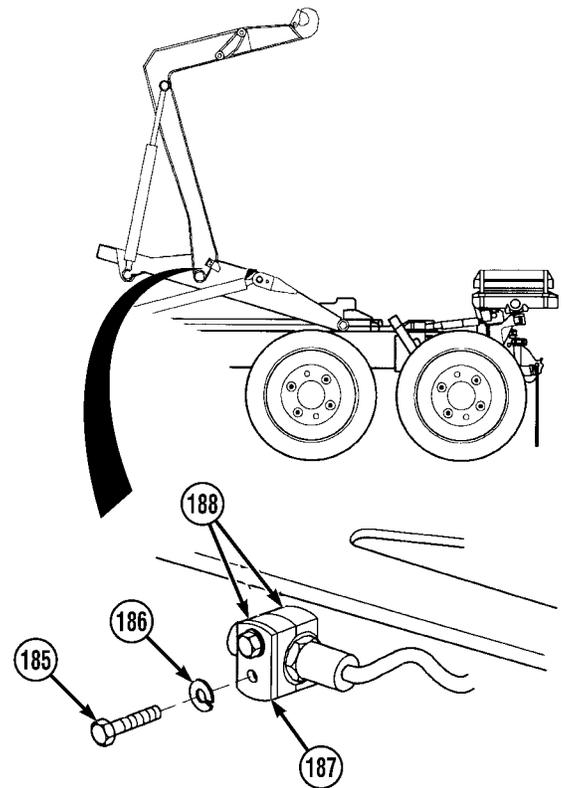
**NOTE**

Proximity switch is properly positioned when two threads extend past edge of nut.

- (163) Position CHU hook arm up proximity switch (190) and two nuts (191) on proximity switch mount (189).
- (164) Connect batteries (TM 9-2320-279-20).

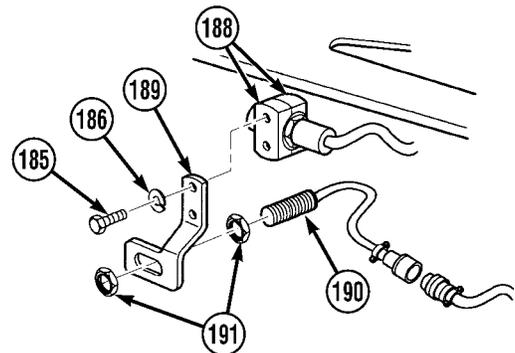

Direct Support and General Support Maintenance (Cont)

5-43. CONTAINER HANDLING UNIT (CHU) KIT INSTALLATION (CONT).

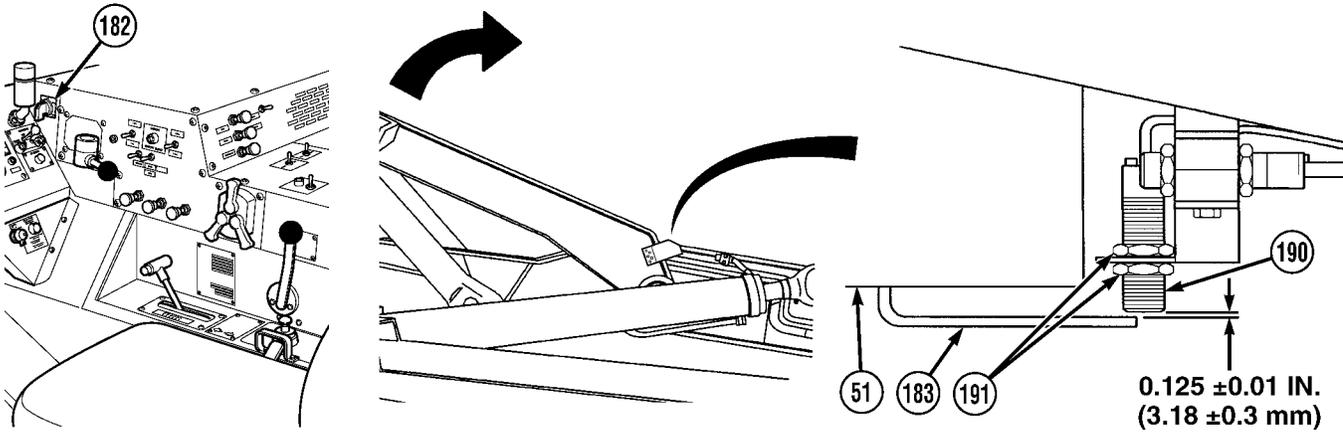

(165) Start engine (TM 9-2320-279-10).

CAUTION

Engine speed must be a idle before using hydraulic selector switch, or damage to equipment may result.

- (166) Set hydraulic selector switch (182) to MAN H.A. position and raise hook arm (51) until sensor plate (183) covers approximately half of proximity switch (190) (Para 2-9).
- (167) Shut OFF engine (TM 9-2320-279-10).
- (168) Using feeler gage, adjust clearance between CHU proximity switch (190) and sensor plate (183) to 0.125 ± 0.01 in. (3.18 ± 0.3 mm) and tighten nuts (191).
- (169) Disconnect batteries (TM 9-2320-279-20).

Direct Support and General Support Maintenance (Cont)

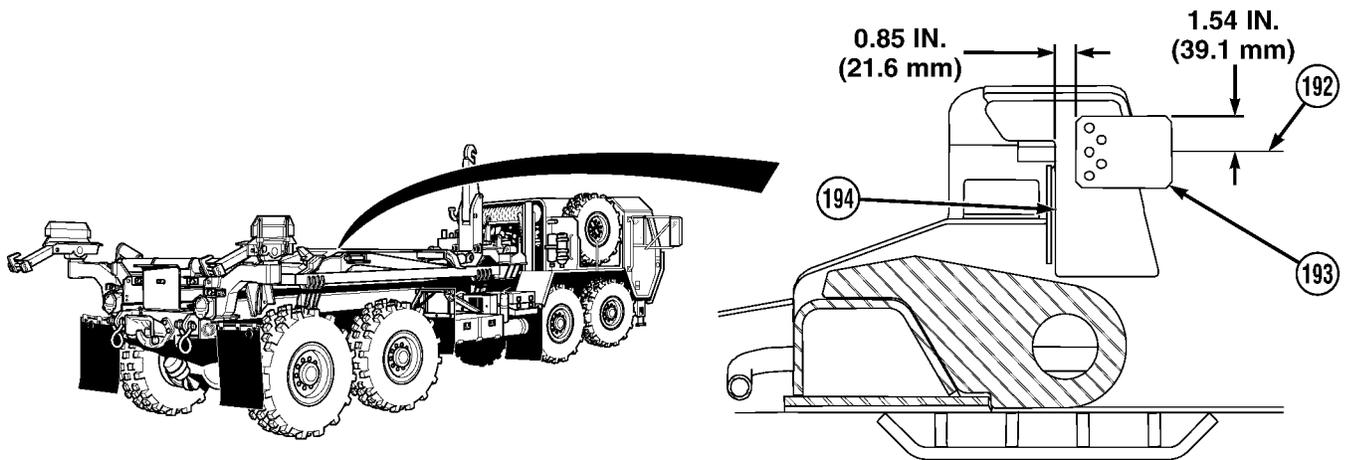
**WARNING**

CARC paint contains isocyanate (HDI), which is highly irritating to skin and respiratory system. High concentrations of HDI can produce symptoms of itching and reddening of skin, a burning sensation in throat and nose, and watering of the eyes. In extreme concentrations, HDI can cause cough, shortness of breath, pain during respiration, increased sputum production, and chest tightness. The following precautions must be taken whenever using CARC paint:

- ALWAYS use air line respirators when using CARC paint unless air sampling shows exposure to be below standards. Use chemical cartridge respirator if air sampling is below standards.
- DO NOT let skin or eyes come in contact with CARC paint. Always wear protective equipment (gloves, ventilation mask, safety goggles, etc.).
- DO NOT use CARC paint without adequate ventilation.
- NEVER weld or cut CARC-coated materials.
- DO NOT grind or sand painted equipment without high-efficiency, air-purifying respirators in use.
- BE AWARE of CARC paint exposure symptoms; symptoms can occur a few days after initial exposure. Seek medical help immediately if symptoms are detected.

- (170) Measure and mark an area on compression frame (192) for sensor plate (193) to be mounted as shown.
- (171) Grind off paint in area marked in step (170) for sensor plate (193) to be mounted.
- (172) Mark compression frame (192) 0.85 in. (21.6 mm) from DIN lock surface (194) on compression frame.
- (173) Aline sensor plate (193) 1.54 in. (39.1 mm) above top edge of compression frame (192).

Direct Support and General Support Maintenance (Cont)

5-43. CONTAINER HANDLING UNIT (CHU) KIT INSTALLATION (CONT).

- (174) Position sensor plate (193) with two clamps on compression frame (192) as shown.
- (175) Mark line around sensor plate (193) on compression frame (192).
- (176) Remove two clamps and sensor plate (193) from compression frame (192).

WARNING

Adhesives, solvents, and sealing compounds can burn easily, can give off harmful vapors, and are harmful to skin and clothing. To avoid injury or death, keep away from open fire and use in well-ventilated area. If adhesive, solvent, or sealing compound gets on skin or clothing, wash immediately with soap and water.

NOTE

Mix epoxy according to directions on package.

- (177) Mix epoxy supplied with CHU kit and apply to sensor plate (193) and compression frame (192).

NOTE

Epoxy takes approximately 15 minutes to cure.

- (178) Clamp sensor plate (193) to compression frame (192) in position marked until cured.
- (179) Remove clamps from compression frame (192).
- (180) Prime and paint area as necessary (TM 43-0139).

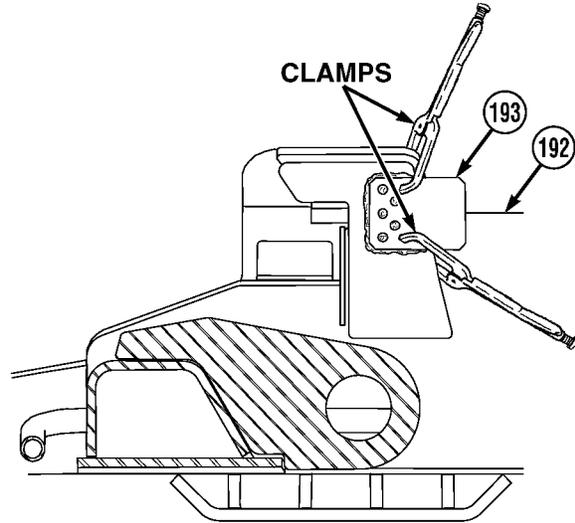

Direct Support and General Support Maintenance (Cont)

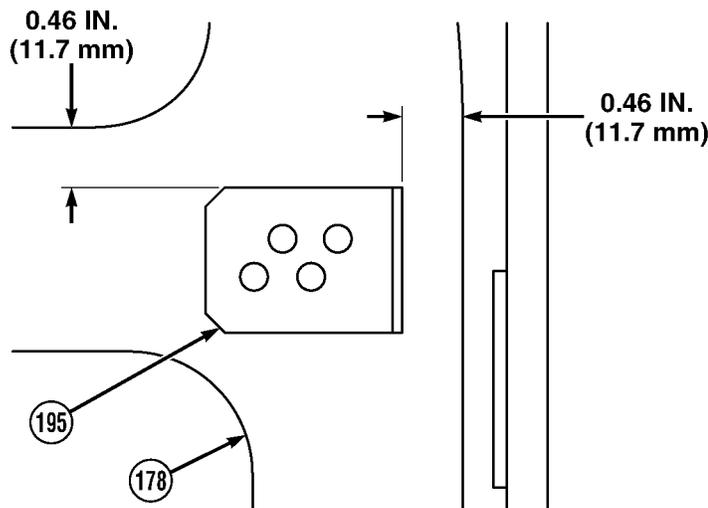
**WARNING**

CARC paint contains isocyanate (HDI), which is highly irritating to skin and respiratory system. High concentrations of HDI can produce symptoms of itching and reddening of skin, a burning sensation in throat and nose, and watering of the eyes. In extreme concentrations, HDI can cause cough, shortness of breath, pain during respiration, increased sputum production, and chest tightness. The following precautions must be taken whenever using CARC paint:

- ALWAYS use air line respirators when using CARC paint unless air sampling shows exposure to be below standards. Use chemical cartridge respirator if air sampling is below standards.
- DO NOT let skin or eyes come in contact with CARC paint. Always wear protective equipment (gloves, ventilation mask, safety goggles, etc.).
- DO NOT use CARC paint without adequate ventilation.
- NEVER weld or cut CARC-coated materials.
- DO NOT grind or sand painted equipment without high-efficiency, air-purifying respirators in use.
- BE AWARE of CARC paint exposure symptoms; symptoms can occur a few days after initial exposure. Seek medical help immediately if symptoms are detected.

- (181) Measure and mark an area on main frame (178) for proximity switch mounting plate (195) to be mounted as shown.
- (182) Grind off paint in area marked in step (181) for proximity switch mounting plate (195) to be mounted.
- (183) Mark main frame (178) 0.46 in. (11.7 mm) in from edge of main frame.
- (184) Aline proximity switch mounting plate (195) 0.46 in. (11.7 mm) below top edge of main frame (178).

Direct Support and General Support Maintenance (Cont)

5-43. CONTAINER HANDLING UNIT (CHU) KIT INSTALLATION (CONT).

- (185) Position proximity switch mounting plate (195) with two clamps on main frame (178) as shown.
- (186) Mark a line around proximity switch mounting plate (195) on main frame (178).
- (187) Remove two clamps and proximity switch mounting plate (195) from main frame (178).

WARNING

Adhesives, solvents, and sealing compounds can burn easily, can give off harmful vapors, and are harmful to skin and clothing. To avoid injury or death, keep away from open fire and use in well-ventilated area. If adhesive, solvent, or sealing compound gets on skin or clothing, wash immediately with soap and water.

NOTE

Mix epoxy according to directions on package.

- (188) Mix epoxy supplied with CHU kit and apply to proximity switch mounting plate (195) and main frame (178).

NOTE

Epoxy takes approximately 15 minutes to cure.

- (189) Clamp proximity switch mounting plate (195) to main frame (178) until cured.
- (190) Remove clamps from main frame (178).
- (191) Prime and paint area as necessary (TM 43-0139).

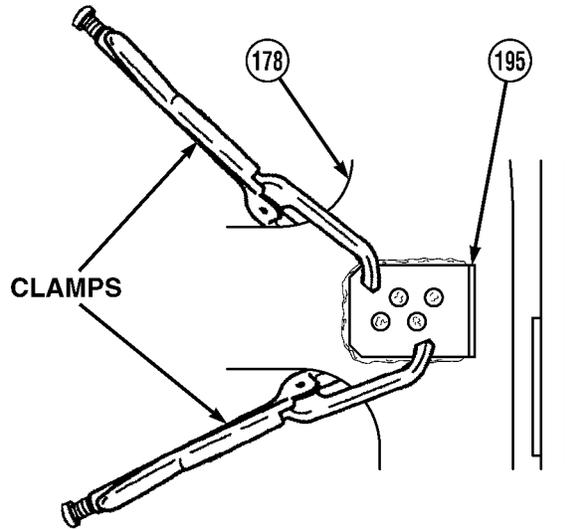

Direct Support and General Support Maintenance (Cont)

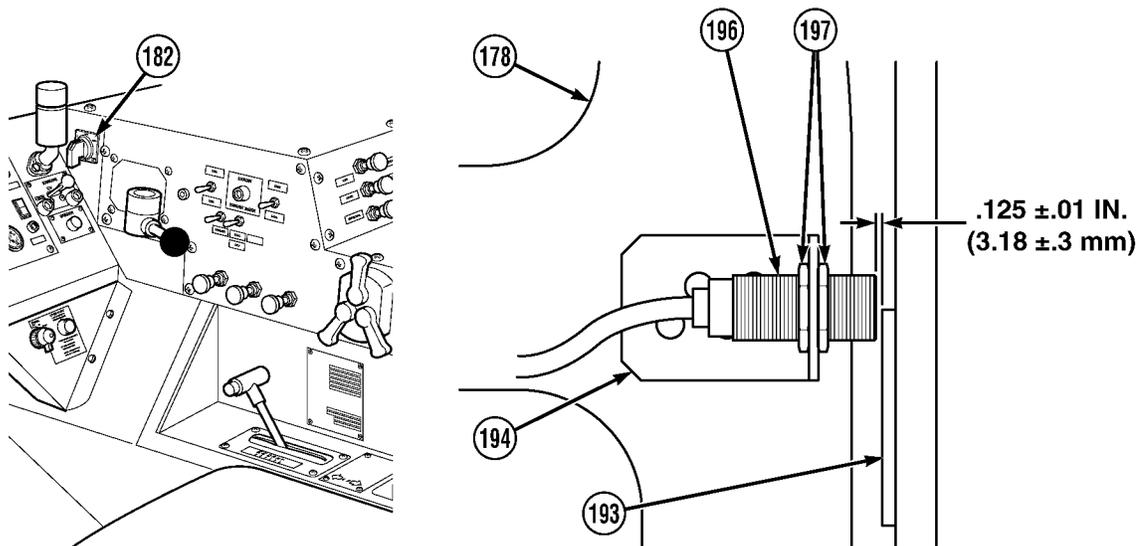
**NOTE**

Proximity switch is properly positioned when two threads extend past edge of nut.

- (192) Position CHU main frame up proximity switch (196) on proximity switch mount (194).
- (193) Connect batteries (TM 9-2320-279-20).
- (194) Start engine (TM 9-2320-279-10).

CAUTION

Engine speed must be at idle before using hydraulic selector switch, or damage to equipment may result.

- (195) Set hydraulic selector switch (182) to MAN M.F. position and raise main frame (178) until approximately half of proximity switch (196) is covered by sensing plate (193).
- (196) Shut OFF engine (TM 9-2320-279-10).
- (197) Using feeler gage, adjust clearance between CHU proximity switch (196) and sensing plate (193) to 0.125 ± 0.01 in. (3.18 ± 0.3 mm) and tighten nuts (197).
- (198) Disconnect batteries (TM 9-2320-279-20).

Direct Support and General Support Maintenance (Cont)

5-43. CONTAINER HANDLING UNIT (CHU) KIT INSTALLATION (CONT).

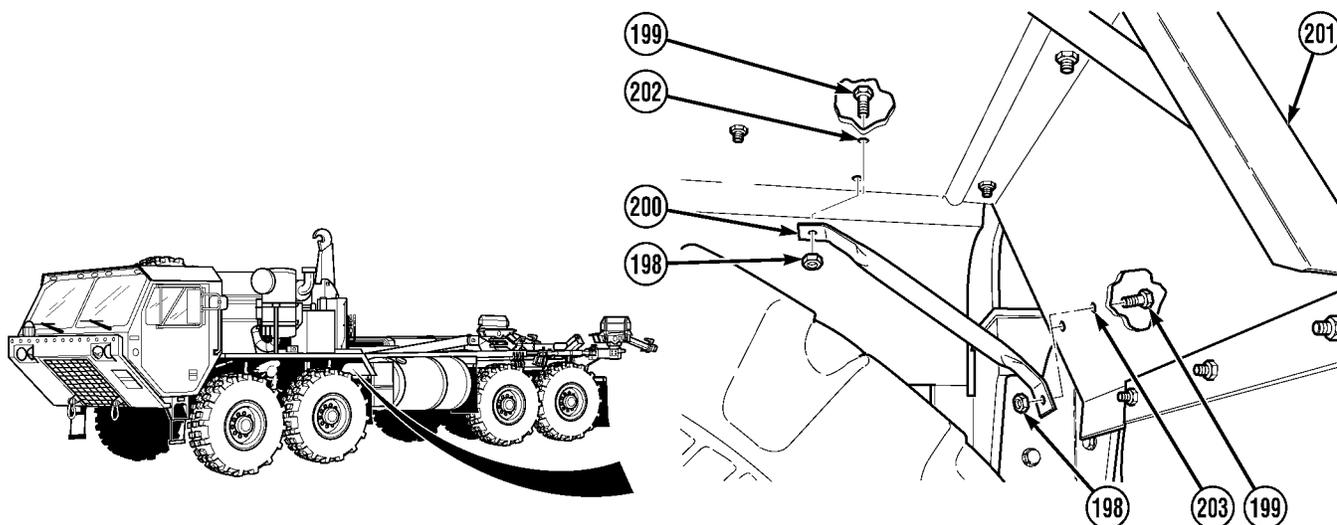

- (199) Remove two locknuts (198), two screws (199), and fender brace (200) from fender (201).
- (200) Install screw (199), upper end of fender brace (200), and locknut (198) into existing hole (202) in fender (201). Do not tighten screw.
- (201) Using lower end of fender brace (200), mark position for lower fender brace hole (203).
- (202) Drill 0.489-in. (12.42 mm) hole each at points (202 and 203).
- (203) Install screw (199), lower end of fender brace (200), and locknut (198) using hole (203).
- (204) Tighten two screws (199).

Direct Support and General Support Maintenance (Cont)

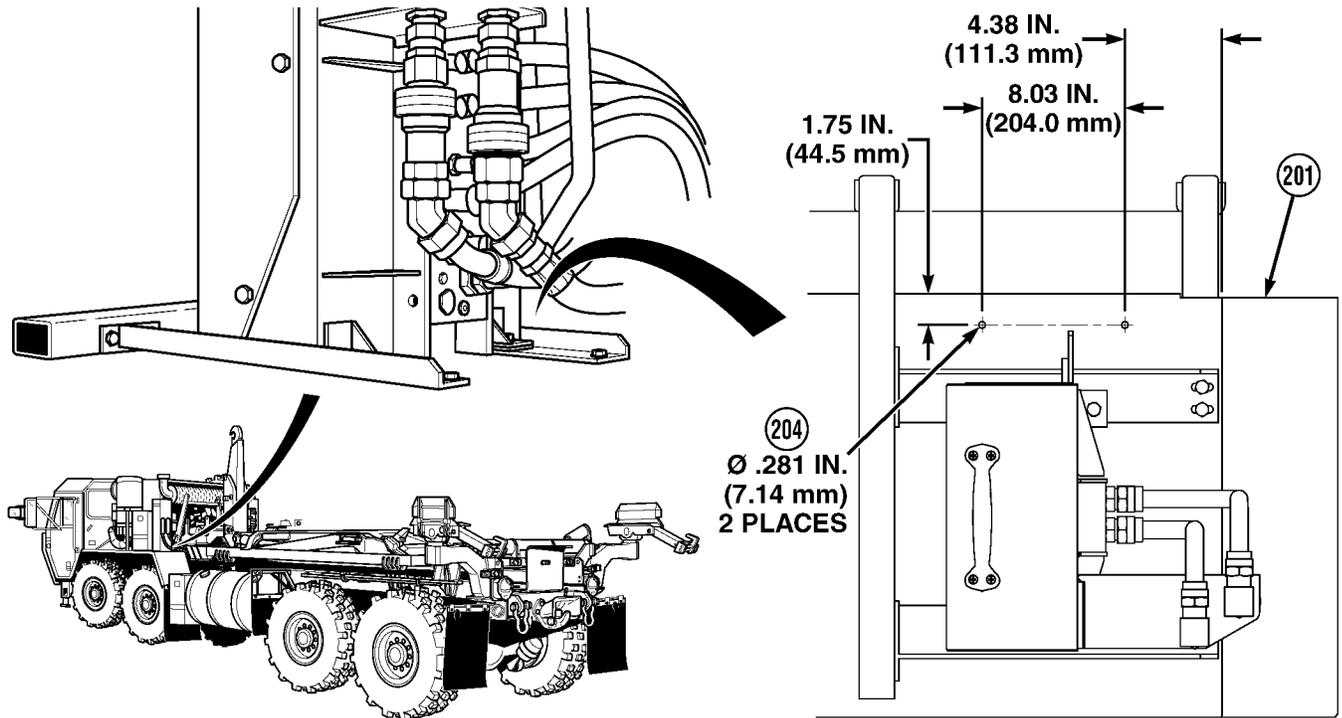

NOTE

Move hoses aside, as required, to mark all drill fender positions.

- (205) Measure and mark two new hole positions (204) on left fender (201) as shown.
- (206) Drill on 0.281 in. (7.14 mm) hole each at screw positions (204).

Direct Support and General Support Maintenance (Cont)

5-43. CONTAINER HANDLING UNIT (CHU) KIT INSTALLATION (CONT).

NOTE

Move hoses, as required, to position control box and plate.

(207) Install CHU control box assembly (205) and plate (206) on fender (201) with four screws (207), washers (208), and nuts (209). Tighten nuts.

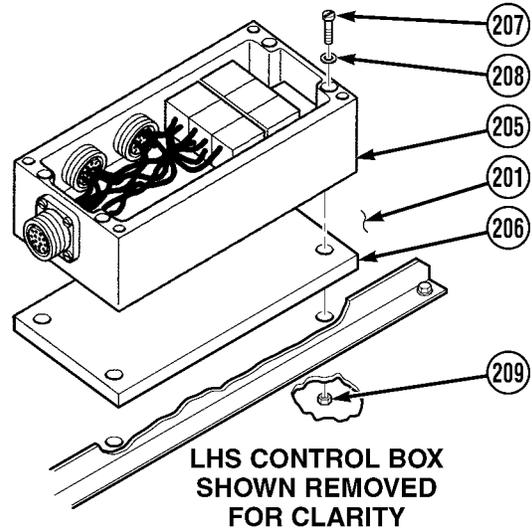

(208) Install cover (210) on CHU control box assembly (205) with four screws (211). Tighten screws.

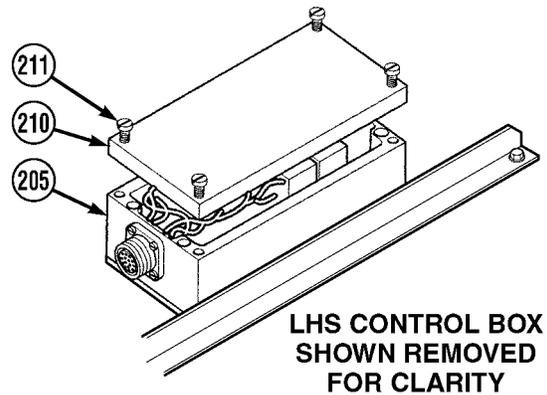

(209) Connect MC185A connector (212), MC82B connector (213), and MC82A connector (214) on CHU control box assembly (205).

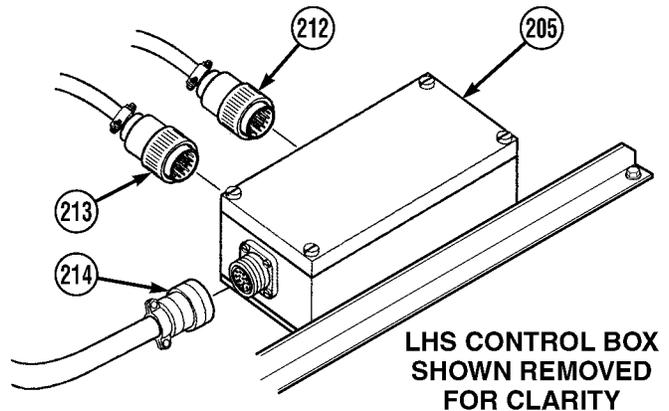

Direct Support and General Support Maintenance (Cont)

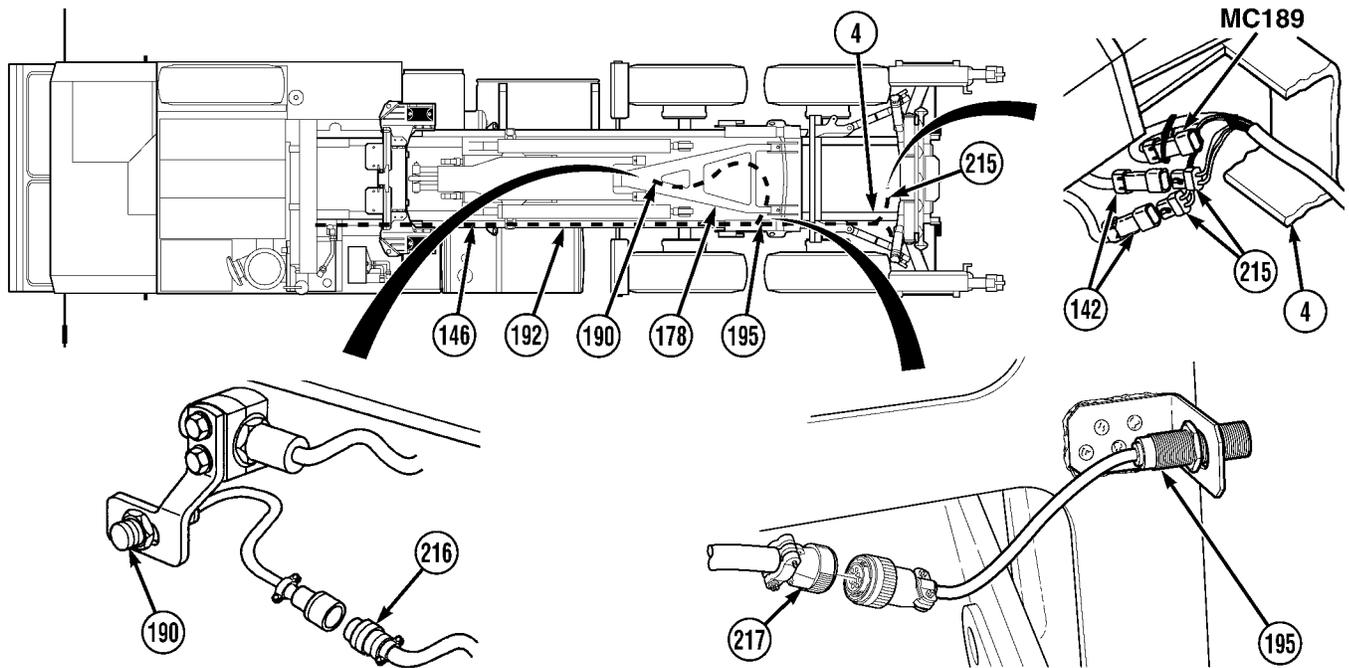

NOTE

- Install cable ties as required.
- Connector MC189 does not connect to anything. MC189 is removed with the CHU wiring harness.

- (210) Position CHU wire harness (146) and two MC190 connectors (215) along inside of left-side frame rail (4).
- (211) Position CHU wiring harness (146) with MC188 connector (216) along inside of compression frame (192) with existing wires.
- (212) Position CHU wiring harness (146) with MC185 connector (217) along inside of main frame (178) with existing wires.
- (213) Connect two MC190 connectors (215) to right and left rear lock limit switch (142).
- (214) Connect MC188 connector (216) to CHU hook arm up arm proximity switch (190).
- (215) Connect MC186 connector (217) to CHU main frame up proximity switch (195).

Direct Support and General Support Maintenance (Cont)

5-43. CONTAINER HANDLING UNIT (CHU) KIT INSTALLATION (CONT).

(216) Connect MC82 connector (218) to LHS main control box (219).

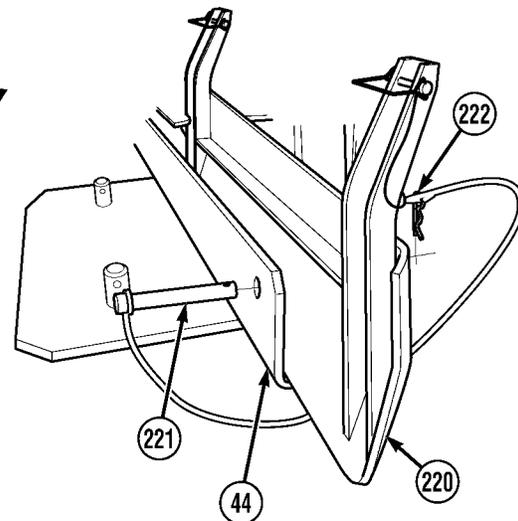
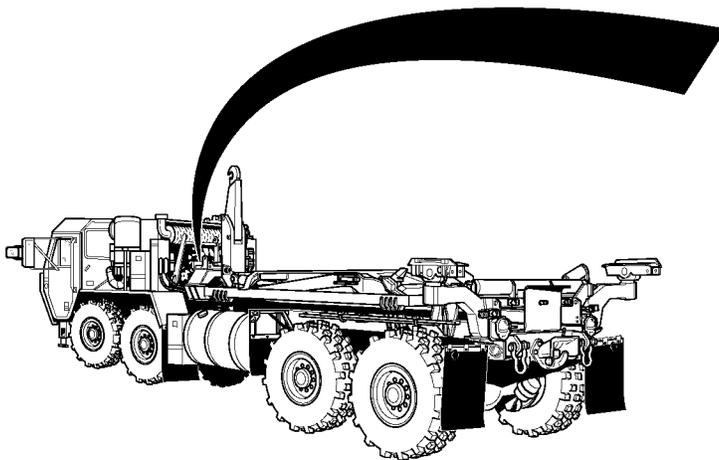
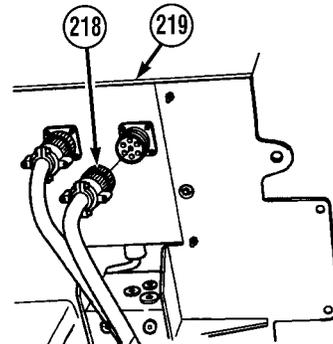

NOTE

Installation of left-side and right-side container guides is the same. Left side is shown.

(217) Install container guide (220) with pin (221) and lock pin (222) on stowage tray (44).

Direct Support and General Support Maintenance (Cont)

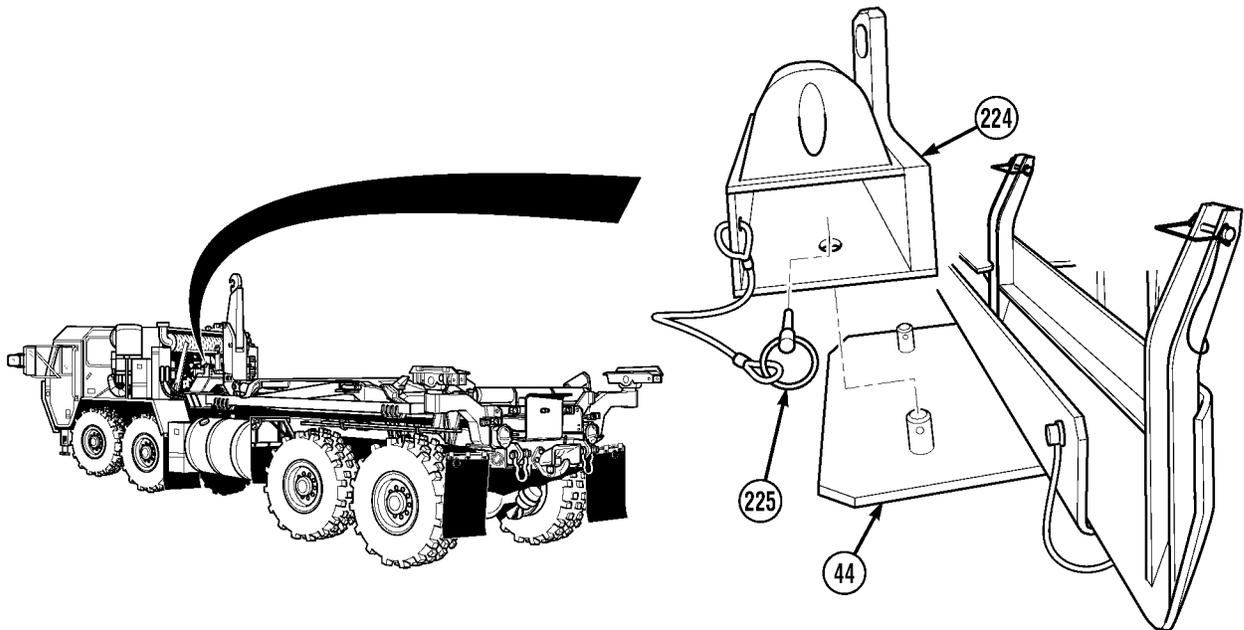

- (218) Stow bumper support (224) on stowage tray (44).
- (219) Install lock pin (225) in bumper support (224).
- (220) Repeat steps (217) through (219) for right side.

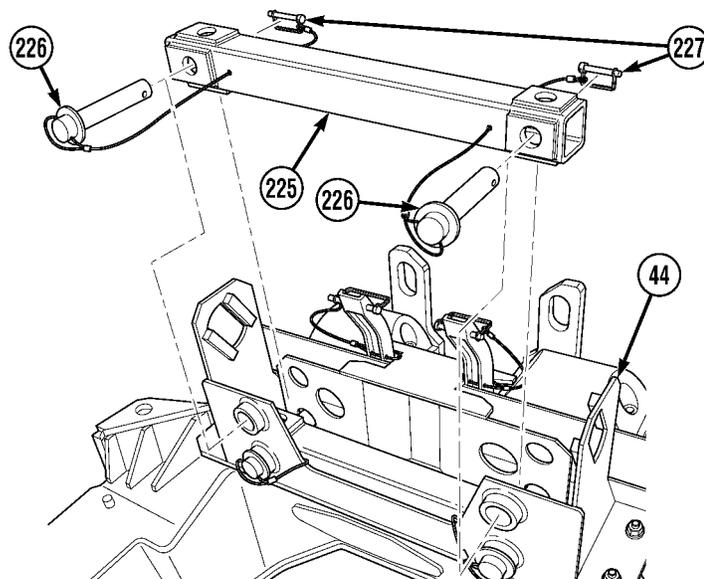
**NOTE**

Rail transport struts are positioned on in “S” shorter hole placement, with “S” facing outward.

- (221) Position rail transport strut (225) on stowage tray (44) with two pins (226) and lock pins (227).

Direct Support and General Support Maintenance (Cont)

5-43. CONTAINER HANDLING UNIT (CHU) KIT INSTALLATION (CONT).

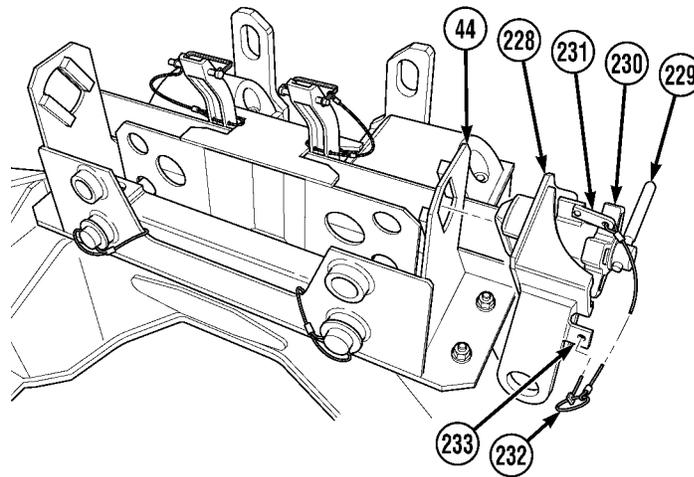

- (222) Install ISO corner lock (228) on stowage tray (44) and rotate lock handle (229) 90 degrees.
- (223) Tighten handnut (230), rotate tab (231) to lock handnut, and install lock pin (232) in bracket (233).
- (224) Repeat steps (221) through (223) for left side.

b. Adjustment.

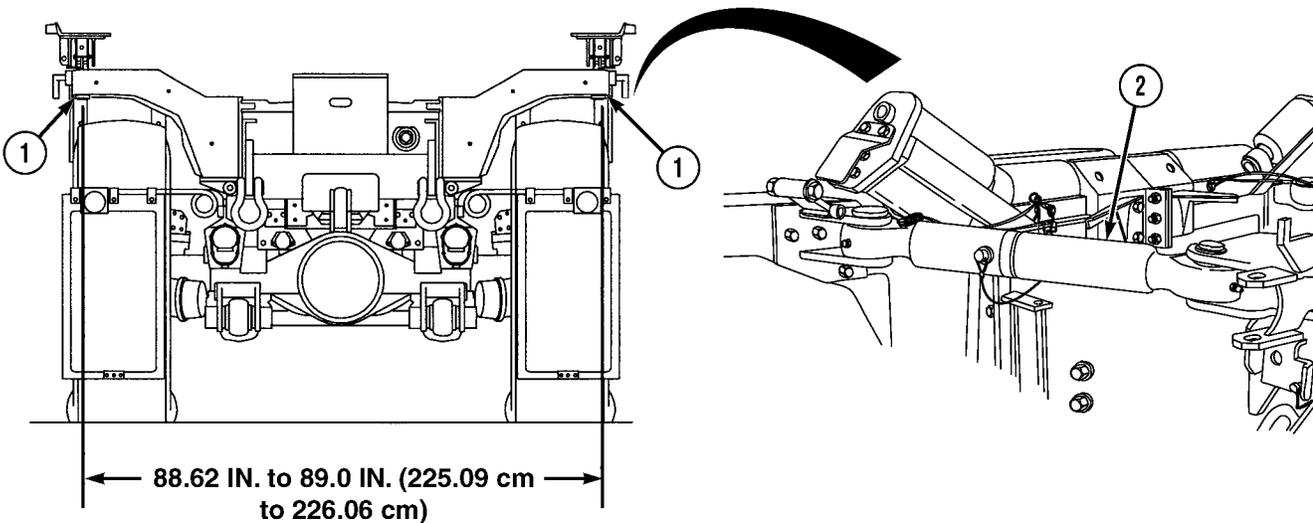

- (1) Deploy both slider assemblies by extending short and long struts (Para 2-9).
- (2) Soldier A and Soldier B measure distance between centers of slider pivot pins (1).

NOTE

Adjustment of struts is performed in steps (3) through (13). If distance measured is 88.62 to 89.00 in. (225.09 to 226.06 cm), no adjustment is required.

- (3) Adjust long struts (2) so distance measured is 88.62 to 89.00 in. (225.09 to 226.06 cm) between slider pivot pin (1) centers.

Direct Support and General Support Maintenance (Cont)

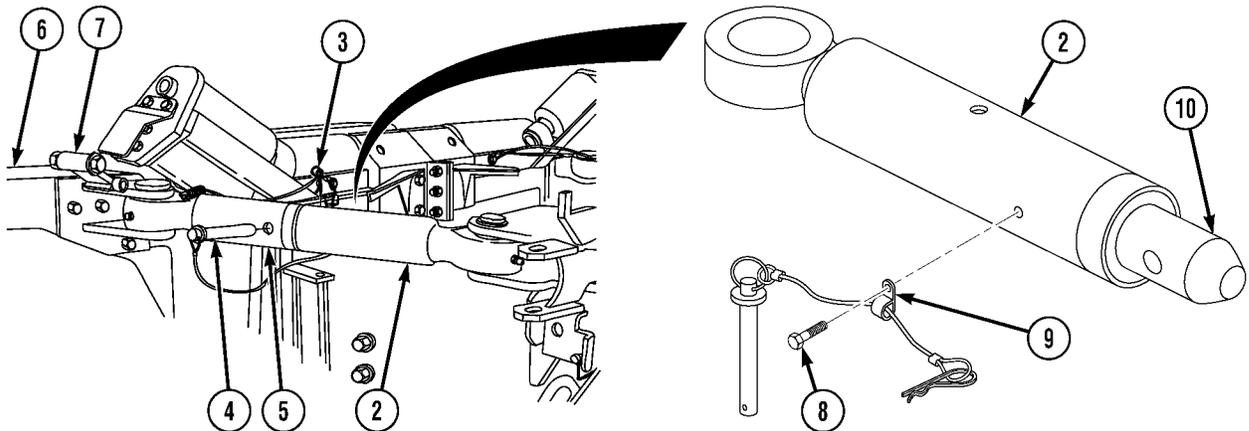

- (4) Remove quick release pin (3) and pin (4) from short strut (5) and long strut (2).
- (5) Using handle of arm assembly (6), rotate arm assembly out to separate short strut (5) and long strut (2).
- (6) Position flip lock (7) up to hold arm assembly (6) out. Release arm assembly.

NOTE

- Rotating pin end of long strut counterclockwise 1/2 turn will decrease width measurement by approximately 1/16 in. (1.59 mm).
- Rotating pin end of long strut clockwise 1/2 turn will increase width measurement by approximately 1/16 in. (1.59 mm).
- Adjust both RH and LH long struts equally to obtain the correct width measurement.

- (7) Remove screw (8) and cushion clip (9) from long strut (2).

CAUTION

Do not unscrew pin end too far. Gap between long strut tube and pin end flange should not exceed 0.75 in. (19.1 mm). Failure to have sufficient engagement of pin end into long strut could result in damage to equipment.

- (8) Rotate pin end (10) as required for correct width measurement.

Direct Support and General Support Maintenance (Cont)

5-43. CONTAINER HANDLING UNIT (CHU) KIT INSTALLATION (CONT).

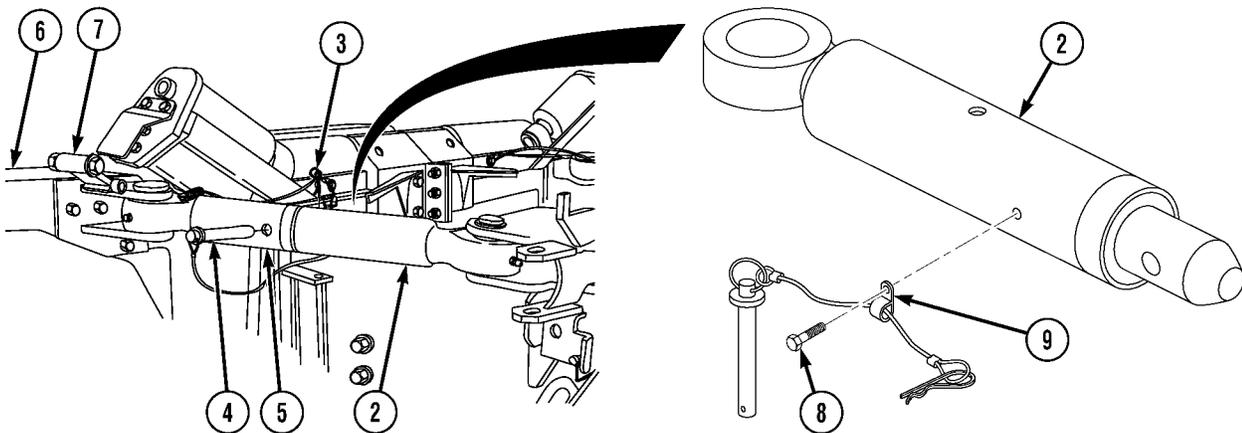

WARNING

Adhesives, solvents, and sealing compounds can burn easily, can give off harmful vapors, and are harmful to skin and clothing. To avoid injury or death, keep away from open fire and use in well-ventilated area. If adhesive, solvent, or sealing compound gets on skin or clothing, wash immediately with soap and water.

NOTE

Make sure hole in pin end aligns with hole for cushion clip.

- (9) Apply sealing compound (Loctite 242) to threads of screw (8).
- (10) Install screw (8) and cushion clip (9) to long strut (2).
- (11) Aline long strut (2) with short strut (5).
- (12) Using handle of arm assembly (6), rotate arm assembly and disengage flip lock (7).
- (13) Position long strut (2) in short strut (5) and install pin (4) and quick release pin (3).
- (14) Repeat steps (2) through (13) as necessary.
- (15) Repeat steps (4) through (13) for left side.

Direct Support and General Support Maintenance (Cont)

NOTE

- Make sure slider arm is deployed.
- Both flip lock brackets are adjusted the same way. Right side shown.

- (16) Remove quick release pin (3) and pin (4) from short strut (5) and long strut (2).
- (17) Using handle of arm assembly (6), rotate arm assembly out and separate short strut (5) from long strut (2).
- (18) Holding arm assembly (6) out, Soldier A positions flip lock (7) up.

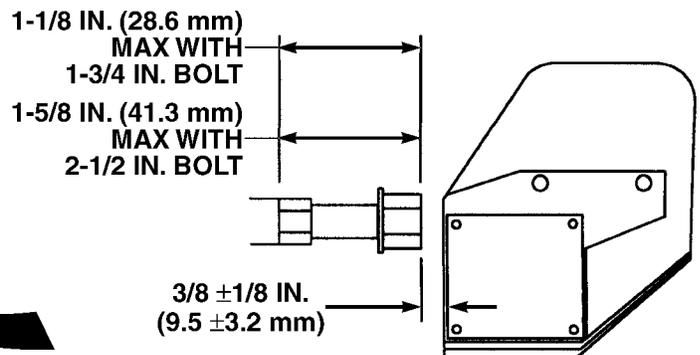
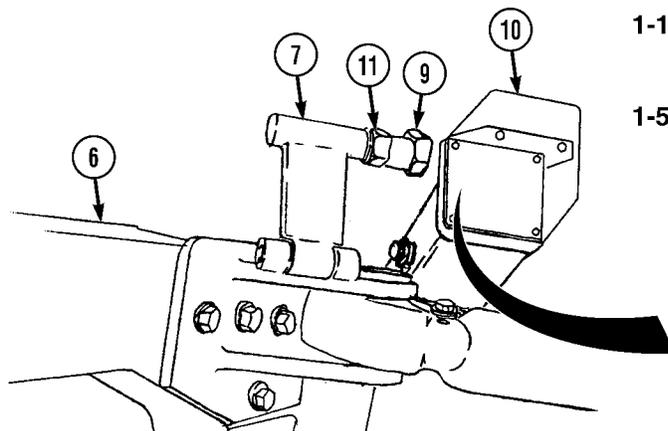
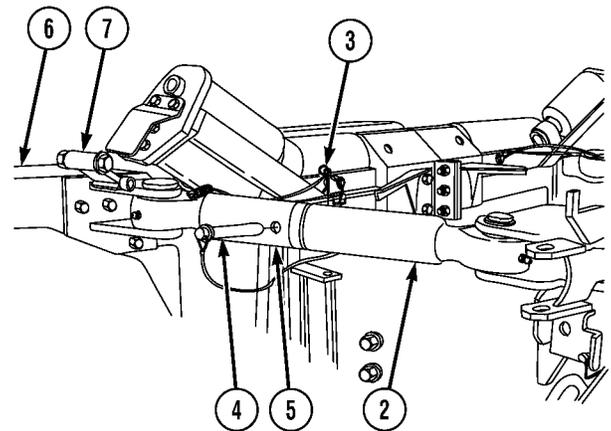

- (19) Soldier B measures gap between stop bolt (9) and right rear roller bracket (10).

NOTE

- If gap is not 3/8 ± 1/8 in. (9.5 ± 3.2 mm), perform steps (20) and (21).
- If gap is 3/8 ± 1/8 in. (9.5 ± 3.2 mm), go to step (22).
- If dimension of gap is greater than 1.25 in. (3.18 cm) following adjustment, or proper adjustment cannot be done, replace stop bolt with 2.50-in. (6.4 cm) long stop bolt.

- (20) Loosen jam nut (11) and adjust stop bolt (9) as required.
- (21) Tighten jam nut (11) on stop bolt (9).
- (22) If proper adjustment could not be made, repeat steps (18) through (21) using longer bolt.

Direct Support and General Support Maintenance (Cont)

5-43. CONTAINER HANDLING UNIT (CHU) KIT INSTALLATION (CONT).

NOTE

Make sure rear sliders are deployed in step (23).

(23) Start engine (TM 9-2320-279-10).

CAUTION

Engine speed must be at idle before using hydraulic selector switch, or damage to equipment may result.

(24) Set hydraulic selector switch (12) to AUTO (Para 2-9).

NOTE

LHS may be extended approximately 12 in. (30 cm) after hook arm cylinder stops and main frame cylinder extends to make measurement in step (27) easier.

(25) Extend hook arm cylinder (13) until hook arm cylinder stops and main frame cylinder (14) start to move.

(26) Shut OFF engine (TM 9-2320-279-10).

NOTE

- If measurement in step (27) is 77 ± 0.25 in. (196 ± 0.6 mm), go to step (32).
- If measurement in step (27) is not 77 ± 0.25 in. (196 ± 0.6 mm), perform steps (28) through (30).

(27) With the aid of Soldier B, measure distance between centers of two hook arm cylinder pivot pins (15).

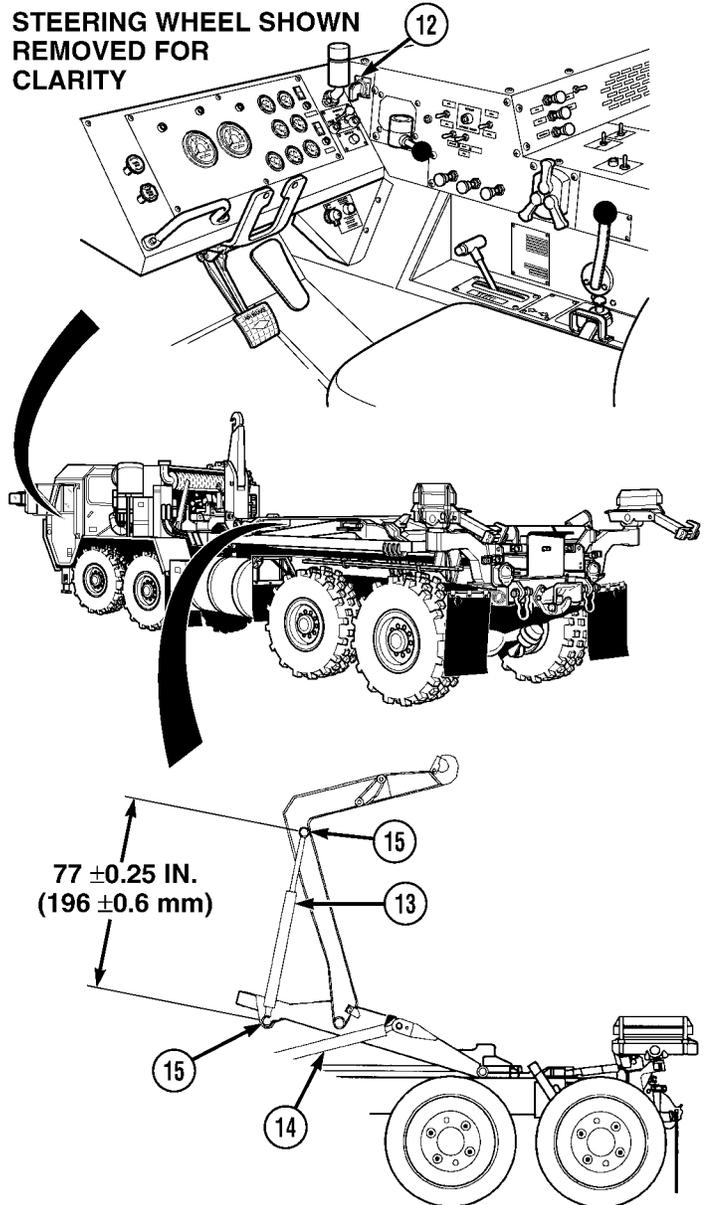

Direct Support and General Support Maintenance (Cont)

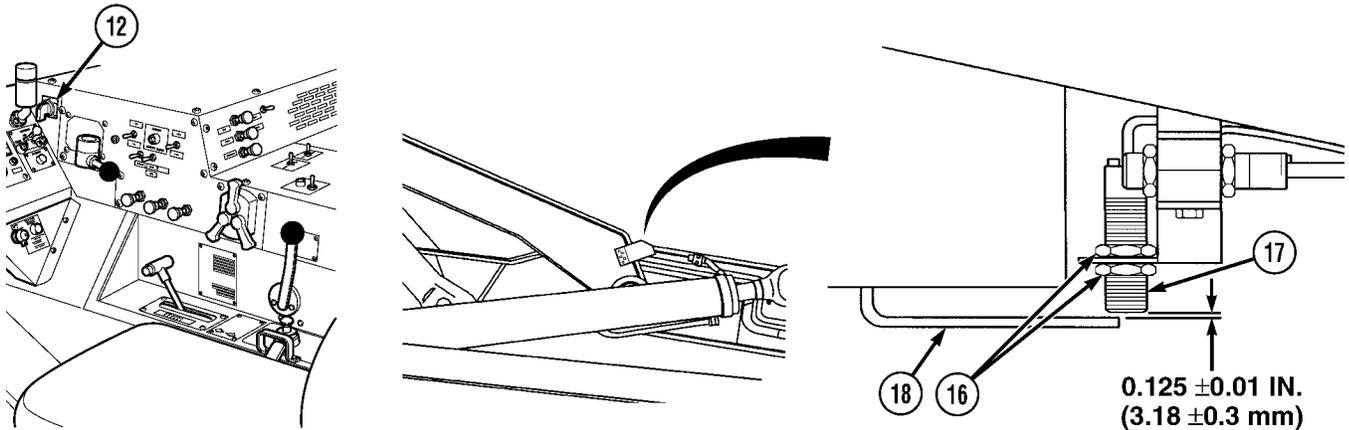
**NOTE**

- Moving proximity switch toward rear lengthens hook arm cylinder.
- Moving proximity switch toward front shortens hook arm cylinder.

- (28) Loosen two nuts (16) on proximity switch (17) and move proximity switch as required.
- (29) Tighten two nuts (16) on proximity switch (17).
- (30) Start engine (TM 9-2320-279-10).
- (31) Stow LHS (Para 2-9).
- (32) Repeat steps (27) through (29) until hook arm cylinder length is 77 ± 0.25 in. (196 ± 0.6 mm).
- (33) Using feeler gage, adjust clearance between CHU proximity switch (17) and sensor plate (18) to 0.125 ± 0.01 in. (3.18 ± 0.3 mm) and tighten nuts (16).
- (34) Start engine (TM 9-2320-279-10).
- (35) Stow LHS (Para 2-9).
- (36) Shut OFF engine (TM 9-2320-279-10).

Direct Support and General Support Maintenance (Cont)

5-43. CONTAINER HANDLING UNIT (CHU) KIT INSTALLATION (CONT).

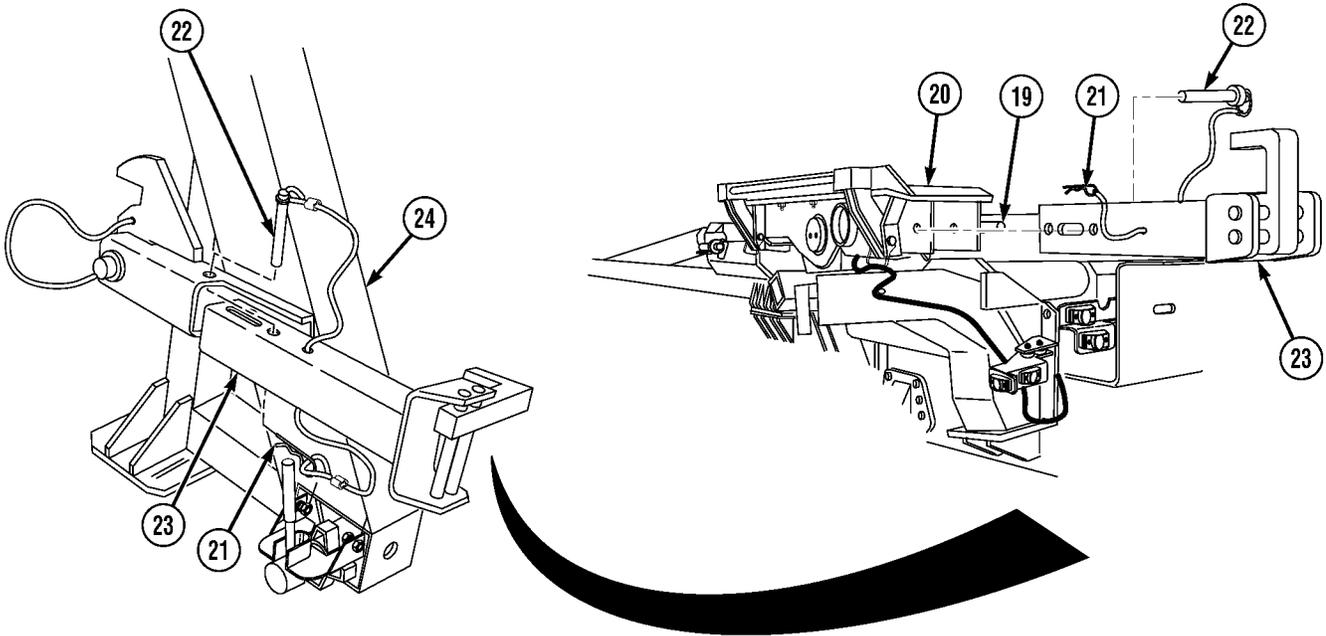

(37) Position slider in container mode (Para 2-10.1).

(38) Raise LHS in AUTO mode approximately 18 in. (46 cm) (Para 2-9).

NOTE

- Both rear container locks are installed the same way. Left side shown.
- Lock handle is unlocked when facing front of slider.

(39) Turn lock handle (19) on left rear slider assembly (20) forward to unlocked position.

(40) Remove lock pin (21), pin (22), and rear container lock (23) from front lift adapter (24).

(41) Position rear container lock (23) in locked position on left rear slider assembly (20) and install pin (22) and lock pin (21).

(42) Turn lock handle (19) on left rear slider assembly (20) back to locked position.

Direct Support and General Support Maintenance (Cont)

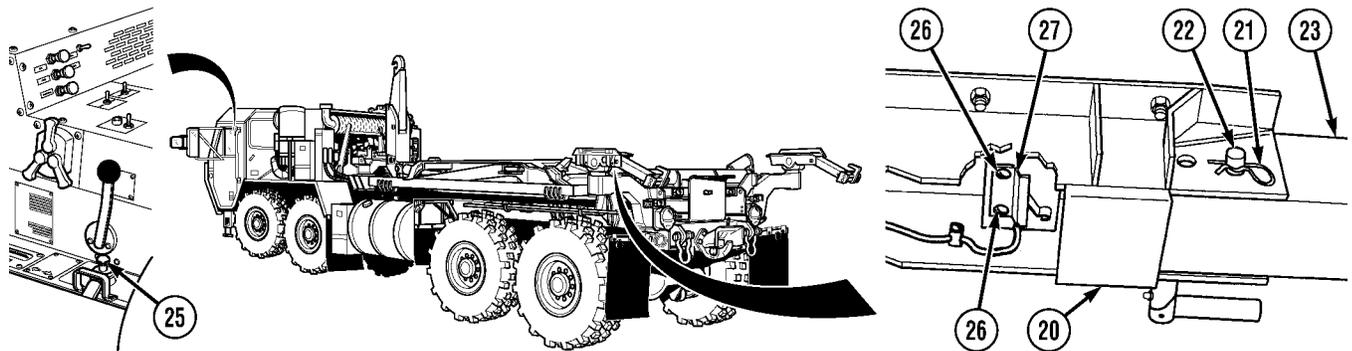
**NOTE**

- LHS should not move when joystick is in UNLOAD position.
- If LHS does not move in UNLOAD position, go to step (50).
- If LHS moves in UNLOAD position, perform steps (44) through (48).

- (43) Move joystick (25) to UNLOAD position and check LHS for movement (Para 2-9).
 (44) Position container lock (23) in locked position and install pin (22) and lock pin (21).
 (45) Remove two screws (26) from lock limit switch (27).

WARNING

Adhesives, solvents, and sealing compounds can burn easily, can give off harmful vapors, and are harmful to skin and clothing. To avoid injury or death, keep away from open fire and use in well-ventilated area. If adhesive, solvent, or sealing compound gets on skin or clothing, wash immediately with soap and water.

- (46) Apply sealing compound to threads of two screws (26).
 (47) Position lock limit switch (27) with two screws (26) on slider (20).

NOTE

Lock limit switch is properly adjusted when lever is depressed and lock limit switch makes an audible click.

- (48) Position lock limit switch (27) against container lock (23) until audible click is heard, then tighten two screws (26).
 (49) Repeat step (43) to check LHS for movement.

Direct Support and General Support Maintenance (Cont)

5-43. CONTAINER HANDLING UNIT (CHU) KIT INSTALLATION (CONT).

WARNING

Container lock could drop suddenly if not supported. Failure to comply may result in injury to personnel.

- (50) Support rear container lock (23) and remove lock pin (21) and pin (22) from rear container lock (23).

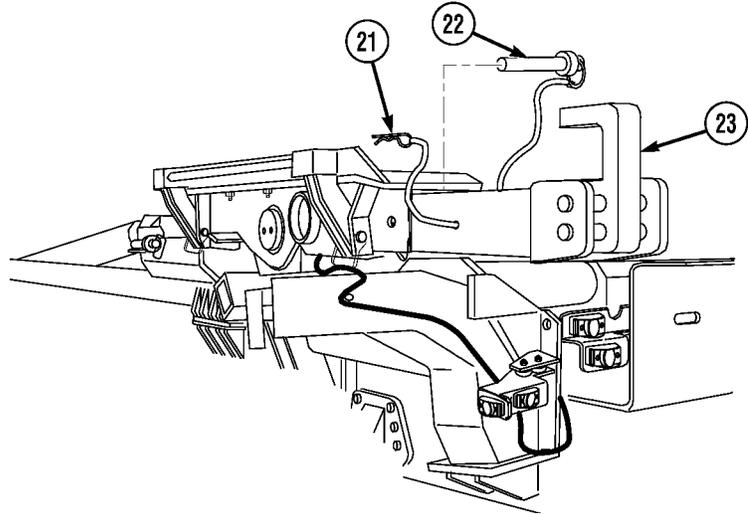

- (51) Position and lock rear container lock (23) in ready mode position by pulling out, rotating down, and inserting pin (22) and lock pin (21).
- (52) Repeat steps (39) through (51) for right side of truck.

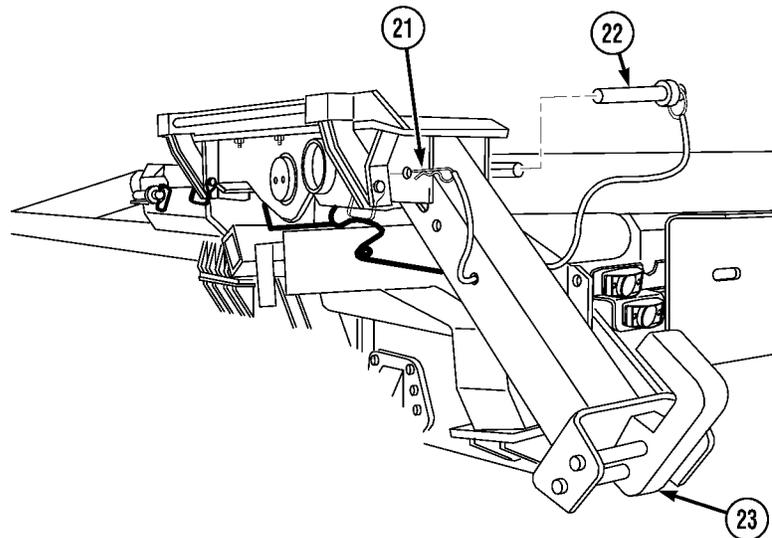

c. Follow-on Maintenance.

- (1) Install fuel tank (TM 9-2320-279-20).
- (2) Install bumper stop bracket (Para 2-9).
- (3) Install rear composite lights (TM 9-2320-279-20).
- (4) Lubricate CHU (Para 3-2).
- (5) Remove wheel chock (TM 9-2320-279-10).

END OF TASK

APPENDIX A REFERENCES

A-1. SCOPE.

Indexes should be consulted frequently for latest changes or revisions of references given in this appendix and for new publications relating to material covered in this publication.

A-2. FORMS.

Refer to DA PAM 738-750, The Army Maintenance Management System (TAMMS), for instructions on the use of maintenance forms pertaining to the vehicle.

A-3. FIELD MANUALS.

The following publications contain information pertinent to the vehicle material.

Camouflage	FM 20-3
Manual for Wheel Vehicle Driver	FM 21-305
Nuclear, Biological, and Chemical Defense	FM 21-40
Basic Cold Weather Manual	FM 31-70
Northern Operations	FM 31-71
Chemical, Biological, and Radiological (CBR) Decontamination	FM 3-5
Nuclear, Biological, and Chemical (NBC) Reconnaissance and Decontamination Operations (How to Fight)	FM 3-89 (HTF)
Army Motor Transport Units and Operations	FM 55-30
Operation and Maintenance of Ordnance Material in Cold Weather 0°F to -65°F	FM 9-27

A-4. TECHNICAL MANUALS.

Painting Instructions	TM 42-0139
General Shop Practice Requirements for Repair, Maintenance, and Test of Electronic Equipment	TM 43-0158
Administrative Storage of Equipment	TM 740-90-1
Procedures for Destruction of Tank Automotive Equipment to Prevent Enemy Use (U.S. Army Tank-Automotive Command)	TM 750-244-6
Operator's and Organizational Support Maintenance Manual for Care, Maintenance, Repair, and Inspection of Pneumatic Tires and Inner Tubes	TM 9-2610-200-14
Operator/Unit/Direct Support/General Support Maintenance Manual Including Repair Parts and Special Tools List for Simplified Test Equipment For Internal Combustion Engines	TM 9-4910-571-12&P
Maintenance and Repair for Lead-Acid Storage Batteries	TM 9-6140-200-14
Inspection, Care, and Maintenance of Antifriction Bearings	TM 9-214
Materials Used for Cleaning, Preserving, Abrading, and Cementing Ordnance Material and Related Materials Including Chemicals	TM 9-247
Operators Manual, M977 Series, 8x8 Heavy Expanded Mobility Tactical Trucks (HEMTT)	TM 9-2320-279-10

A-4. TECHNICAL MANUALS (CONT).

Maintenance Instructions, Organizational Maintenance M977 Series, 8x8 Heavy Expanded Mobility Tactical Trucks (HEMTT) TM 9-2320-279-20

Operator's Unit, Direct Support and General Support Maintenance Manual (Including Repair Parts and Special Tools List) for Palletized Load System (PLS) Flatrack model M1077/M1077A1 TM 9-3990-206-14&P

Cooling System: Tactical Vehicles TM 750-254

Operator's, Unit, Direct Support and General Support Maintenance Manual, Palletized Load System Trailer (PLST) TM 9-2320-385-14

Unit, Direct Support and General Support Maintenance Repair Parts and Special Tools List Palletized Load System Trailer (PLST) TM 9-2330-385-24P

Operator's Maintenance Manual for Forward Repair Sytem (FRS) TM 9-4940-568-10

Operator's, Unit, Direct Support & General Support Maintenance Manual (Including Repair & Special Tool List) Model M3 NSN 3990-02-442-2751

Container Roll-In/Out Platform (CROP) TM 9-3990-260-14&P

A-5. MISCELLANEOUS PUBLICATIONS.

Description, Use, Bonding Techniques, and Properties of Adhesive TB ORD1032

Safety Inspection and Testing of Lifting Devices TB 43-0142

Use of Antifreeze Solutions and Cleaning Compounds in

Engine Cooling Systems TB 750-651

Operator's Circular for Welding Theory and Application TC 9-237

APPENDIX B

MAINTENANCE ALLOCATION CHART (MAC)

B-1. GENERAL.

This Maintenance Allocation Chart designates responsibility for performance of maintenance repair functions at specified maintenance levels.

- a.** Section I is a general explanation and definitions of terms.
- b.** Section II shows the maintenance level responsible and estimated work measurement time for specific functions.
- c.** Section III lists common tool sets and the special tools and test and support equipment required for each maintenance function shown in Section III.

B-2. EXPLANATION OF COLUMNS IN SECTION II.

- a. Column 1, Group Number.** Column 1 lists group numbers, the purpose of which is to identify components, assemblies, subassemblies, and modules with the next higher assembly.
- b. Column 2, Component Assembly.** Column 2 contains the noun names of components, assemblies, subassemblies, and modules for which maintenance is authorized.
- c. Column 3, Maintenance Function.** Column 3 lists the functions to be performed on the item listed in Column 2.
- d. Column 4, Maintenance Level.** Column 4 specifies, by the listing of a “work time” figure in the appropriate subcolumn(s), the category of maintenance authorized to perform the function listed in Column 3. This figure represents the active time required to perform that maintenance function at the indicated category of maintenance. If the number or category of the tasks within the listed maintenance function varies at different maintenance categories, appropriate “work time” figure represents the average time required to restore an item (assembly, subassembly, components, module, end item, or system) to a serviceable condition under typical field operating conditions. This time includes preparation time, troubleshooting time, and quality assurance/quality control time in addition to the time required to perform the specific tasks identified for the maintenance functions authorized in the maintenance chart. This figure does not include any time for performance of preliminary tasks listed elsewhere in the MAC (e.g., removal of engine under repair of fuel pump when the engine is listed separately in the MAC). The symbol designations for the various maintenance categories remain as follows:
 - C - Operator/Crew
 - O - Organizational Maintenance
 - F - Direct Support Maintenance
 - H - General Support Maintenance
- e. Column 5, Tools & Equipment.** Column 5 specifies the code, those common tool sets (not individual tools) and special tools, test, and support equipment required to perform the designed functions.
- f. Column 6, Remarks.** Column 6 references any amplifying remarks.

B-3. THE MAINTENANCE FUNCTIONS ARE DEFINED AS FOLLOWS:

a. Inspect. To closely and critically examine (i.e., sight, sound, or feel) an item to detect errors, flaws, wear, etc., and to determine its condition and serviceability by comparing its physical mechanical/electrical characteristics within established standards.

b. Test. To verify serviceability and detect incipient failure by measuring the mechanical or electrical characteristics of an item and comparing those characteristics with prescribed standards.

c. Service Operations required periodically to keep an item in proper operating condition; i.e., to clean (decontaminate), to preserve, to drain, to paint, or to replenish fuel, lubricants, hydraulic fluids, or compressed air supplies.

d. Adjust. To maintain, within prescribed limits, by bringing into proper or exact position, or by setting the operating characteristics to specified parameters.

e. Aline. To adjust specified variable elements of an item to bring about optimum or desired performance.

f. Calibrate. To determine and cause corrections to be made or to be adjusted on instruments or test measuring and diagnostic equipment used in precision measurement. Consists of comparison of two instruments, one of which is a certified standard of known accuracy, to detect and adjust any discrepancy in the accuracy of the instrument being compared.

g. Install. The act of emplacing, seating, or fixing into position an item, part, or module (component or assembly) for an unserviceable counterpart.

h. Repair. The application of maintenance services (inspect, test, service, adjust, aline, calibrate, or replace) or other maintenance actions (welding, grinding, riveting, straightening, facing, remachining, or resurfacing) to restore serviceability to an item by correcting specific damage, fault malfunction, or failure in a part, subassembly, module (components or assembly), item, or system.

i. Overhaul. That maintenance effort (service/action) necessary to restore an item to a completely serviceable/operational condition as prescribed by maintenance standards (e.g., DMWR) in appropriate technical publications. Overhaul is normally the highest degree of maintenance performed by the Army. Overhaul does not normally return an item to like-new condition.

j. Rebuild. Consists of those services/actions necessary for the restoration of unserviceable equipment to a like new condition in accordance with original manufacturing standards. Rebuild is the highest degree of materiel maintenance applied to Army equipment. The rebuild operation includes the act of returning to zero those age measurements (hours/miles, etc.) considered in classifying Army equipment/components.

Section I. Maintenance Allocation Chart

(1) Group Number	(2) Component Assembly	(3) Maintenance Function	(4) Maintenance Level				(5) Tools & Equipment	(6) Remarks
			C	O	F	H		
06	ELECTRICAL SYSTEM							
0607	Instrument or Engine Control Panel	Repair		*				
0608	Miscellaneous Items: Proximity Switches (LHS) (each)	Replace		0.5		33, 20, 10	B	
		Adjust		*				
		Test		0.5		33, 21		
	Hook Arm Harness	Repair		*				
		Replace			*			
	Pressure Harness	Repair		*				
		Replace			*			
0609	Lights							
	Rear Light Bar Assembly	Repair		0.8				
		Replace		1.5				
0613	LHS Wiring Harness	Repair		*				
		Replace			1.5			
15	FRAME TOWING ATTACHEMENTS, DRAWBARS, AND ARTICULATION SYSTEMS							
1501	Frame Assembly							
	Rear Deck Assembly	Replace		0.7				
	Rear Roller Assembly	Replace		1.0				
18	BODY, CAB, HOOD, AND HULL							
1802	Fenders, Running Boards with mounting and attaching Parts, Windshield Glass	Replace		0.7				
1808	Stowage Racks, Boxes, Straps, Carrying Cases, Cable Reels, Hose Reels: Ladder Support	Replace		0.5		33, 20		
		Repair		*		33, 20		
22	BODY, CHASSIS, OR HULL & ACCESSORY ITEMS							
2202	Accessory Items	Replace		0.5				
2210	Data Plates and Instruction Holders	Replace		0.5				
24	HYDRAULIC AND FLUID SYSTEMS							

(1) Group Number	(2) Component Assembly	(3) Maintenance Function	(4) Maintenance Level				(5) Tools & Equipment	(6) Remarks
			C	O	F	H		
2400	Major Assemblage	Inspect	0.1					
2400	Major Assemblage (Load Handling Systems)	Service Test Replace Repair		*	0.6 2.0 2.0	32, 22 32, 22, 2, 40	A	
2402	Manifold and/or Control Valves							
	LHS Load-Sensing Valve	Replace Test		*	0.5	33, 20	B	
2405	Mast Column	Service		*			A	
	LHS Hook Arm Cylinder	Replace Repair			1.4 2.5	32, 22, 18, 46 32, 22, 1, 35		
2406	Strainers, Filters, Lines and Fittings, etc.	Adjust Replace Test			0.5 1.0 0.5	22 32, 22 22		
	LHS Frame Main Cylinder	Replace Repair			1.1 2.5	32 32, 22, 18, 46		
	LHS Hook Arm Manifold Assembly	Replace Repair			1.6 1.6	33, 40, 42		
	LHS Main Manifold	Replace Repair			0.6 0.6	32, 22, 2 32		
	LHS Main Cylinder	Replace Repair			1.1 2.5	32 32, 20, 16, 43		
33	SPECIAL PURPOSE KITS							
3307	CHU Control Box Repair	Repair		*		33	B	
	CHU Proximity Switch and Sensing Plate (Hook Arm Up)	Adjust Replace		0.5 *		33, 10	A B	
	CHU Rear Lock Limit Switch	Adjust Replace		0.3 *		33	A B	
	CHU Light Bar and Brackets Assembly	Repair		0.8		33	B	
	CHU Container Guide	Repair		*		33	B	
	CHU Slider/Pivot Assembly	Repair		*		33, 19.1	B	
	CHU Short Strut and Pin Bracket Assembly	Repair		*		33, 19.1	B	
	CHU Slider Arm Assembly	Repair		*		33, 19.1	B	
	CHU Long Strut Bracket Assembly	Repair		*		33, 19.1	B	
	CHU Front Lift Adapter Lower Container Lock Plate	Repair		*		33	B	

(1) Group Number	(2) Component Assembly	(3) Maintenance Function	(4) Maintenance Level				(5) Tools & Equipment	(6) Remarks
			C	O	F	H		
	CHU Front Lift Adapter Flipper Bracket and Lock Plate	Repair			*		33	B
	CHU Pivot	Repair		*			33	B
	CHU Front Lift Adapter	Repair			*		33	B
	Lower Container Lock Handle							
	CHU Rail Transport ISO Corner Locks	Repair		*			33	B

Section II. Tool and Test Equipment Requirements

B-4. TOOLS, TEST EQUIPMENT, AND TOOL KITS GENERAL.

Tool or Test Equipment Ref Code	Maintenance Category	Nomenclature	National/ NATO Stock Number	Tool Number
1	O	Analyzer Set, STE/ICE-R	1910-01-222-6589	12259266
2	O	Cap and Plug Set	5340-00-450-5718	10935405
2.1	O	Clamp, Machinist's	5120-00-222-1612	GGG-C-406
2.2	F	Compressor Unit, Air	4130-00-752-9633	MIL-C-13874
3	O	Connector Remover	5120-01-158-4707	114010
4	O	Crimping Tool	5120-01-355-0844	J35123
5	O	Drill Set, Twist	5133-00-449-6775	GGG-D-751
6	O	Drill, Electric, Portable, 1/4 in.	5130-00-889-8993	1070
7	O	Extractor Tool, Electrical	5120-01-015-2154	901019-3
8	O	Extractor Tool, Electrical	5120-01-020-5926	305183
9	O	Gage, Feeler	5210-01-214-2138	007958
10	O	Gage, Feeler, Jacobs Brake	5210-01-214-2938	007958
11	O	Gloves, Chemical Oil Protective	8415-00-641-4601	ZZ-G-381
12	O	Goggles, Industrial	4140-00-269-7912	GGG-G-13
12.1	F	Gun, Air Blow	4940-00-333-5541	AA55543 TY2 CL1 STA
13	O	Kit, Pressure Test		4SK777
14	O	Insertion Tool, (Cannon)	5120-01-374-8967	CIT-SS-10
15	O	Multiplier, Torque	5120-00-574-9318	SC4910-95-A72-HR
16	O	Pan, Drain 4 gal	4910-00-387-9592	450
17	O	Pliers, Channel Lock	5120-00-287-2512	GGG-W-649

Tool or Test Equipment Ref Code	Maintenance Category	Nomenclature	National/ NATO Stock Number	Tool Number
18	F	Pliers, Channel Lock	5120-00-287-2412	GGG-W-649
19	O	Pliers, Retaining Ring	5120-00-288-9717	0200
19.1	O	Pliers, Retaining Ring	5120-01-375-5699	2BH945
19.2	O	Puller Kit, Universal	5180-00-423-1596	1677
20	O	Shop Equipment, Automotive Maintenance and Repair: Common No. 1	4910-00-754-0654	SC 4910-95-A74
21	O	Shop Equipment, Automotive Maintenance and Repair: Common No. 2	4910-00-754-0650	SC 4910-95-A72-HT
22	F	Shop Equipment, Automotive Maintenance and Repair: Field Maintenance, Basic	4910-00-754-0705	SC 4910-95-A31
23	O	Socket Set, 3/4 in.	5120-00-204-1999	SC4910-95-A72-HR
24	O	Stone, Sharpening	5345-00-584-4607	A6F0
25	O	Tape, Measuring	5210-00-234-6745	D-1420-A
26	O	Terminal Crimper	5120-01-355-0845	J356898
27	O	Terminal Remover	5120-01-353-2534	J33095
28	O	Terminal Remover	5120-01-357-2937	J33095-A
29	O	Terminal Remover (Weatherpac)	5120-01-374-8969	J36400-5
30	O	Tool Kit, Blind Rivet	5180-01-201-4978	D-100-MIL-1
31	O	Tool Kit, Electric	5180-00-876-9336	7550526
32	F	Tool Kit, General Mechanic's	5180-00-699-5273	SC5180-90-CL-N05
33	O	Tool Kit, General Mechanic's: Automotive	5180-00-177-7033	SC 5180-90-N26
34	O	Torch, Propane	3433-01-161-4998	737-1-0000
35	F	Vise, Pipe, Chain	5120-00-078-6662	CV12
36	O	Weatherpac Crimper	5120-00-374-8936	J38852
37	O	Wrench, Combination 1-1/8 in.	5120-00-228-9516	1172
38	O	Wrench, Combination 1-1/4 in.	5120-00-228-9517	1173
39	O	Wrench, Combination 1-1/2 in.	5120-00-277-8834	1178
40	O	Wrench, Combination 1-5/8 in.	5120-01-016-7144	1180
41	O	Wrench, Combination 1-13/16 in.	5120-00-081-9099	GGG-W-636TY4
42	O	Wrench, Combination 1-7/8 in.	5120-00-020-8632	1260
43	O	Wrench, Combination 2-1/8 in.	5120-00-203-4795	1268
44	O	Wrench Set, Socket 3/8 in. Drive	5120-00-322-6231	51200017510

Tool or Test Equipment Ref Code	Maintenance Category	Nomenclature	National/ NATO Stock Number	Tool Number
45	O	Wrench Set, Socket 3/4 in. Drive	5120-00-204-1999	FEDSTD353
46	F	Wrench, Spanner	5120-01-375-4502	J41108
47	O	Wrench, Torque (0-60 N•m)	5120-01-112-9531	TESI60
48	O	Wrench, Torque (0-175 lb-ft. [0-237 N•m])	5120-00-640-6364	A-A-2411
49	O	Wrench, Torque (0-600 lb-ft. [0-814 N•m])	5120-00-221-7983	SW130-301

Section III. Remarks

REFERENCE CODE	REMARKS
A	No specific times established. Times required for inspection, service, or test will depend on extent of testing required.
B	No specific times established. Times required for replacement or repair will depend on extent of work required.

APPENDIX C

REPAIR PARTS AND SPECIAL TOOLS LIST (RPSTL)

Section I. Introduction

C-1. SCOPE. This RPSTL lists and authorizes spares and repair parts; special tools; special test, measurement, and diagnostic equipment (TMDE); and other special support equipment required for performance of organizational, direct support, and general support maintenance of the M1120 series vehicles. It authorizes the requisitioning, issue, and disposition of spares, repair parts, and special tools as indicated by the source, maintenance, and recoverability (SMR) codes.

C-2. GENERAL. In addition to Section I, Introduction, this Repair Parts and Special Tools List is divided into the following sections:

a. Section II. Repair Parts List. A list of spares and repair parts authorized by this RPSTL for use in the performance of maintenance. The list also includes parts which must be removed for replacement of the authorized parts. Parts lists are composed of functional groups in ascending alphanumeric sequence, with the parts in each group listed in ascending figure and item number sequence. Bulk materials are listed in item name sequence. Repair parts kits are listed separately in their own functional group within Section II. Repair parts for repairable special tools are also listed in this section. Items listed are shown on the associated illustration(s)/figure(s).

b. Section III. Special Tools List. A list of special tools, special Test, Measurement and Diagnostic Equipment (TMDE), and other special support equipment authorized by this RPSTL (as indicated by Basis of Issue (BOI) information in DESCRIPTION AND USABLE ON CODE (UOC) column) for the performance of maintenance.

c. Section IV. Cross-reference Index. A list, in National Item Identification Number (NIIN) sequence, of all National stock numbered items appearing in the listing, followed by a list in alphanumeric sequence of all part numbers appearing in the listing. National stock numbers and part numbers are cross-referenced to each illustration figure and item number appearance. The figure and item number index lists figure and item numbers in alphanumeric sequence and cross-reference NSN, CAGE, and part numbers.

C-3. EXPLANATION OF COLUMNS (SECTIONS II AND III).

a. ITEM NO. (Column (1)). Indicates the number used to identify items called out in the illustration.

b. SMR CODE (Column (2)). The Source, Maintenance, and Recoverability (SMR) code is a 5-position code containing supply/requisitioning information, maintenance category authorization criteria, and disposition instructions, as shown in the following breakout:

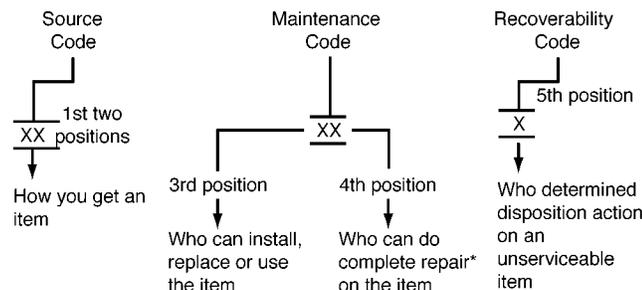

*Complete Repair: Maintenance capacity, capability, and authority to perform all corrective maintenance tasks of the "Repair" function in a use/user environment in order to restore serviceability to a failed item.

(1) *Source Code.* The source code tells you how to get an item needed for maintenance, repair, or overhaul of an end item/equipment. Explanations of source codes follow.

Code	Explanation
PA PB PC** PD PE PF PG	<p>Stocked items; use applicable NSN to request/requisition items with these source codes. They are authorized to the category indicated by the code entered in the 3rd position of the SMR code.</p> <p>**NOTE: Items coded PC are subject to deterioration.</p>
KD KF KB	<p>Items with these codes are not to be requested/requisitioned individually. They are part of a kit which is authorized to the maintenance category indicated in the 3rd position of the SMR code. The complete kit must be requisitioned and applied.</p>
MO- (Made at org Level) MF- (Made at DS Level) MH- (Made at GS Level) ML- (Made at Specialized Repair Act (SRA)) MD- (Made at Depot)	<p>Items with these codes are not to be requested/requisitioned individually. They must be made from bulk material which is identified by the part number in the DESCRIPTION AND USABLE ON CODE (UOC) column and listed in the Bulk Material group of the repair parts list in this RPSTL. If the item is authorized to you by the 3rd position code of the SMR code, but the source code indicates it is made at a higher level, order the item from the higher level of maintenance.</p>
AO- (Assembled by org Level) AF- (Assembled by DS Level) AH- (Assembled by GS Category) AL- (Assembled by SRA) AD- (Assembled by Depot)	<p>Items with these codes are not to be requested/requisitioned individually. The parts that make up the assembled item must be requisitioned or fabricated and assembled at the level of maintenance indicated by the source code. If the 3rd position code of the SMR code authorizes you to replace the item, but the source code indicates the item is assembled at a higher level, order the item from the higher level of maintenance.</p>

- XA - Do not requisition an “XA”-coded item. Order its next higher assembly. (Also, refer to the NOTE below.)
- XB - If an “XB” item is not available from salvage, order it using the CAGE and part number given.
- XC - Installation drawing, diagram, instruction sheet, field service drawing, that is identified by manufacturer’s part number.
- XD - Item is not stocked. Order an “XD”-coded item through normal supply channels using the CAGE and part number given, if no NSN is available.

NOTE

Cannibalization or controlled exchange, when authorized, may be used as a source of supply for items with the above source codes, except for those source coded “XA”.

(2) *Maintenance Code.* Maintenance codes tell you the level(s) of maintenance authorized to USE and REPAIR support items. The maintenance codes are entered in the third and fourth positions of the SMR Code as follows:

(a) The maintenance code entered in the third position tells you the lowest maintenance level authorized to remove, replace, and use an item. The maintenance code entered in the third position will indicate authorization to one of the following levels of maintenance.

Code	Application/Explanation
C	-Crew or operator maintenance done within Organizational Maintenance.
O	-Organizational can remove, replace, and use the item.
F	-Direct support level can remove, replace, and use the item.
H	-General support level can remove, replace, and use the item.
L	-Specialized repair activity can remove, replace, and use the item.
D	-Depot level can remove, replace, and use the item.

(b) The maintenance code entered in the fourth position tells you whether the item is to be repaired and identifies the lowest maintenance level with the capability to perform complete repair (i.e., all authorized maintenance functions). This position will contain one of the following maintenance codes.

Code	Application/Explanation
O	-Organizational is the lowest level that can do complete repair of the item.
F	-Direct support is the lowest level that can do complete repair of the item.
H	-General support is the lowest level that can do complete repair of the item.
L	-Specialized repair activity is the lowest level that can do complete repair of the item.
D	-Depot is the lowest level that can do complete repair of the item.
Z	-Nonreparable. No repair is authorized.
B	-No repair is authorized. (No parts or special tools are authorized for the maintenance of a “B” coded item.) However, the item may be reconditioned by adjusting, lubricating, etc., at the user level.

(3) *Recoverability Code.* Recoverability codes are assigned to items to indicate the disposition action on unserviceable items. The recoverability code is entered in the fifth position of the SMR Code as follows:

Recoverability
Code

Application/Explanation

- Z -Nonreparable item. When unserviceable, condemn and dispose of the item at the level of maintenance shown in 3rd position of SMR Code.
- O -Reparable item. When uneconomically reparable, condemn and dispose of the item at organizational level.
- F -Reparable item. When uneconomically reparable, condemn and dispose of the item at the direct support level.
- H -Reparable item. When uneconomically reparable, condemn and dispose of the item at the general support level.
- D -Reparable item. When beyond lower level repair capability, return to depot. Condemnation and disposal of item not authorized below depot level.
- L -Reparable item. Condemnation and disposal not authorized below specialized repair activity (SRA).
- A -Item requires special handling or condemnation procedures because of specific reasons (e.g., precious metal content, high dollar value, critical material, or hazardous material). Refer to appropriate manuals/directives for specific instructions.

c. CAGEC (Column (3)). The Commercial and Government Entity Code (CAGE) is a 5-digit numeric code which is used to identify the manufacturer, distributor, or Government agency, etc., that supplies the item.

d. PART NUMBER (Column (4)). Indicates the primary number used by the manufacturer (individual, company, firm, corporation, or Government activity), which controls the design and characteristics of the item by means of its engineering drawings, specifications standards, and inspection requirements to identify an item or range of items.

NOTE

When you use an NSN to requisition an item, the item you receive may have a different part number from the part ordered.

e. DESCRIPTION AND USABLE ON CODE (UOC) (Column(5)). This column includes the following information:

- (1) The Federal item name and, when required, a minimum description to identify the item.
- (2) Spare/repair parts that make up an assembled item are listed immediately following the assembled item line entry.
- (3) Part numbers for bulk materials are referenced in this column in the line item entry for the item to be manufactured/fabricated.
- (4) The usable on code, when applicable (see paragraph 5, Special Information).
- (5) In the Special Tools List section, the basis of issue (BOI) appears as the last line(s) in the entry for each special tool, special TMDE, and other special support equipment. When density of equipment supported exceeds density spread indicated in the basis of issue, the total authorization is increased proportionately.
- (6) The statement "END OF FIGURE" appears just below the last item description in Column 5 for a given figure in both Section II and Section III.

f. QTY (Column (6)). The QTY (quantity per figure column) indicates the quantity of the item used in the breakout shown on the illustration figure, which is prepared for a functional group, subfunctional group, or an assembly. A "V" appearing in this column in lieu of a quantity indicates that the quantity is variable and the quantity may vary from application to application.

C-4. EXPLANATION OF COLUMNS (SECTION IV).
--

a. NATIONAL STOCK NUMBER (NSN) INDEX.

- (1) *STOCK NUMBER column.* This column lists the NSN by National item identification number (NIIN) sequence. The NIIN consists of the last nine digits (i.e., $\overbrace{5305-01-674-1467}^{\text{NSN}}$). When using $\underbrace{\hspace{10em}}_{\text{NIIN}}$

the column to locate an item, ignore the first 4 digits of the NSN. However, the complete NSN should be used when ordering items by stock number.

- (2) *FIG. column.* This column lists the number of the figure where the item is identified/located. The figures are in numerical order in Section II and Section III.
- (3) *ITEM column.* The item number identifies the item associated with the figure listed in the adjacent FIG. column. This item is also identified by the NSN listed on the same line.

b. PART NUMBER INDEX. Part numbers in this index are listed by part number in ascending alphanumeric sequence (i.e., vertical arrangement of letter and number combination which places the first letter or digit of each group in order A through Z, followed by the numbers 0 through 9 and each following letter or digit in like order).

- (1) *CAGEC column.* The Commercial and Government Entity Code (CAGEC) is a 5-digit numeric code used to identify the manufacturer, distributor, or Government agency, etc., that supplies the item.
- (2) *PART NUMBER column.* Indicates the primary number used by the manufacturer (individual, firm, corporation, or Government activity) which controls the design and characteristics of the item by means of its engineering drawings, specifications standards, and inspection requirements to identify an item or range of items.
- (3) *STOCK NUMBER column.* This column lists the NSN for the associated part number and manufacturer identified in the PART NUMBER and CAGEC columns to the left.
- (4) *FIG. column.* This column lists the number of the figure where the item is identified/located in Sections II and III.
- (5) *ITEM column.* The item number is that number assigned to the item as it appears in the figure referenced in the adjacent figure number column.

c. FIGURE AND ITEM NUMBER INDEX.

- (1) *FIG. column.* This column lists the number of the figure where the item is identified/located in Sections II and III.
- (2) *ITEMS column.* The item number is that number assigned to the item as it appears in the figure referenced in the adjacent figure number column.
- (3) *STOCK NUMBER column.* This column lists the NSN for the item.
- (4) *CAGEC column.* The Commercial and Government Entity Code (CAGEC) is a 5-digit numeric code used to identify the manufacturer, distributor, or Government agency, etc., that supplies the item.
- (5) *PART NUMBER column.* Indicates the primary number used by the manufacturer (individual, firm corporation, or Government activity), which controls the design and characteristics of the item by means of its engineering drawings, specifications standards, and inspection requirements to identify an item or range of items.

C-5. SPECIAL INFORMATION.

a. USABLE ON CODE. Not applicable.

b. FABRICATION INSTRUCTIONS. Bulk materials required to manufacture items are listed in the Bulk Material Functional Group of this RPSTL. Part numbers for bulk materials are also referenced in the description column of the line entry for the item to be manufactured/fabricated. Detailed fabrication instructions for items source coded to be manufactured or fabricated are found in TM 9-2320-279-24P.

c. ASSEMBLY INSTRUCTION. Detailed assembly instructions for items source coded to be assembled from component spare/repair parts are found in TM 9-2320-279-24P. Items that make up the assembly are listed immediately following the assembled item entry or reference is made to an applicable figure.

d. KITS. Line item entries for repair parts kits appear in a group in Section II. (See table of contents.)

e. INDEX NUMBERS. Items which have the word BULK in the figure column will have an index number shown in the item number column. This index number is a cross-reference between the National Stock Number/Part Number Index and the bulk material list in Section II.

C-6. HOW TO LOCATE REPAIR PARTS.

a. When National Stock Number or Part Number Is Unknown:

- (1) First. Using the table of contents, determine the assembly group or subassembly group to which the item belongs. This is necessary since figures are prepared for assembly groups and subassembly groups, and listings are divided into the same groups.
- (2) Next. Find the figure covering the assembly group or subassembly group to which the item belongs.
- (3) Lastly. Identify the item on the figure and refer to the Figure and Item Number Index to find the NSN.

b. When National Stock Number or Part Number Is Known:

- (1) Using the Index of National Stock Numbers and Part Numbers, find the pertinent National Stock Number or Part Number. The NSN index is in the National Item Identification Number (NIIN) sequence (see C-4.a(1)). The part numbers in the Part Number Index are listed in ascending alphanumeric sequence (see C-4.b). Both indexes cross-reference you to the illustration figure and item number of the item you are looking for.
- (2) After finding the figure and item number, verify that the item is the one you're looking for, then locate the item number in the repair parts list for the figure.

C-7. ABBREVIATIONS. Not applicable.

Section II. Repair Parts List

		Page	Illus Figure
Group 06	Electrical System		
	0607 LHS rotary switch	1-1	1
	0607 Control panels	2-1	2
	0607 LHS control assembly	3-1	3
	0608 LHS proximity switch	4-1	4
	0608 Main junction box (LHS)	5-1	5
	0608 Main junction box (LHS) wiring harness	6-1	6
	0608 Junction box (LHS)	7-1	7
	0608 Junction box (LHS) wiring harness	8-1	8
	0609 Clearance lights	9-1	9
	0609 Rear light bar assembly	10-1	10
	0613 Cab to bulkhead harness	11-1	11
	0613 Cab to interface wiring harness	12-1	12
	0613 Cab to junction box wiring harness	13-1	13
	0613 Junction box to LHS wiring harness	14-1	14
	0613 Wire assembly	15-1	15
	0613 Wire assembly	16-1	16
	0613 Backup alarm harness	17-1	17
	0613 Side clearance light harness	18-1	18
	0613 Clearance light harness, rear	19-1	19
	0613 LHS main wiring harness	20-1	20
Group 15	Frame Towing Attachments, Drawbars, and Articulation Systems		
	1501 LHS roller and roller mounting bracket	21-1	21
	1501 Rear roller mounting assembly	22-1	22
	1501 Platform assembly	23-1	23
Group 18	Body, Cab, Hood, and Hull		
	1802 Rear fender assembly	24-1	24
	1802 Rear mud flap installation	25-1	25
	1802 Ladder support	26-1	26
Group 22	Body, Chassis, or Hull and Accessory Items		
	2202 Rear roller assembly reflectors	27-1	27
	2210 LHS data plates	28-1	28
Group 24	Hydraulic and Fluid Systems		
	2400 Load handling system	29-1	29
	2405 LHS hook arm cylinder	30-1	30
	2406 LHS hook arm manifold	31-1	31
	2406 LHS main manifold, relief valves, and load control valves ...	32-1	32
	2406 LHS main manifold fittings and adapters	33-1	33
	2406 LHS main manifold & junction box mounting	34-1	34
	2406 LHS main manifold to compression frame hoses	35-1	35
	2406 LHS compression frame bulkhead connectors	36-1	36
	2406 LHS compression frame tubes and mountings	37-1	37
	2406 LHS middle frame hydraulic lines and hoses	38-1	38
	2406 LHS middle frame bulkhead connectors	39-1	39
	2406 LHS main cylinder	40-1	40
	2406 LHS main cylinder manifold	41-1	41
	2406 LHS diverter manifold	42-1	42
	2406 LHS disconnect adapters	43-1	43

	Page	Illus Figure
Group 33 Special Purpose Kit		
3307 Sensor harness	44-1	44
3307 Jumper harness	45-1	45
3307 Proximity switch harness	46-1	46
3307 Clearance light wiring harness rear	47-1	47
3307 Proximity switch	48-1	48
3307 Main cylinder proximity switch	49-1	49
3307 Control box	50-1	50
3307 Light bar assembly	51-1	51
3307 Container guide	52-1	52
3307 Slider assembly	53-1	53
3307 Slider arm	54-1	54
3307 Short strut & flip lock pin	55-1	55
3307 Rear container support	56-1	56
3307 Rear container support cross brace	57-1	57
3307 Front container support	58-1	58
3307 Front lifting adapter	59-1	59
3307 Self recovery winch assembly	60-1	60
3307 Data plates	61-1	61
3307 CHU kit pivot pin	62-1	62
Group 94 9401 Repair kits	KITS-1	
Group 95 9501 Bulk materials	BULK-1	
Section III SPECIAL TOOLS LIST		
2604 Special tools	63-1	62
Section IV CROSS-REFERENCE INDEX		
National stock number index	I-1	
Part number index	I-6	
Figure and item number index	I-19	

SECTION II

TM 9-2320-304-14&P

(1) ITEM NO	(2) SMR CODE	(3) CAGEC CAGEC	(4) PART NUMBER	(5) DESCRIPTION AND USABLE ON CODES(UOC)	(6) QTY
GROUP 06 ELECTRICAL SYSTEM					
GROUP 0607 INSTRUMENT OR ENGINE					
CONTROL PANEL					
FIG. 1 LHS ROTARY SWITCH					
1	PBOOO	45152	1891360U	ROTARY CAM SWITCH ASSY	1
2	PFOZZ	77060	12015799	.CONNECTOR, PLUG, ELEC	1
3	MOOZZ	45152	121782A-006	.WIRE MAKE FROM WIRE P/N 121782A (45152), 6 IN LG	3
4	MOOZZ	45152	121782A-007	.WIRE MAKE FROM WIRE 121782A (45152), 7 IN LG	1
5	MOOZZ	45152	121782A-003	.WIRE MAKE FROM WIRE P/N 121782A (45152), 3 IN LG	3
6	PAOZZ	77060	12089040	.CONTACT, ELECTRICA	6
7	PAOZZ	77060	12015323	.BOOT, DUCT	12
8	MOOZZ	45152	121782A-004	.WIRE MAKE FROM WIRE P/N 121782A (45152), 4 IN LG	2
9	MOOZZ	45152	121782A-005	.WIRE MAKE FROM WIRE P/N 121782A (45152), 5 IN LG	3
10	PAOZZ	12603	2775859	.CONNECTOR, PLUG, ELEC	1
11	PAOZZ	77060	1203 4051	.SOCKET, CONTACT	6
12	PBOZZ	51918	9003-K2M0083US	.SWITCH, ROTARY CAM	1
13	PFOZZ	51917	9003-KAE1B	OPERATOR, ROTARY SWITCH	1

END OF FIGURE

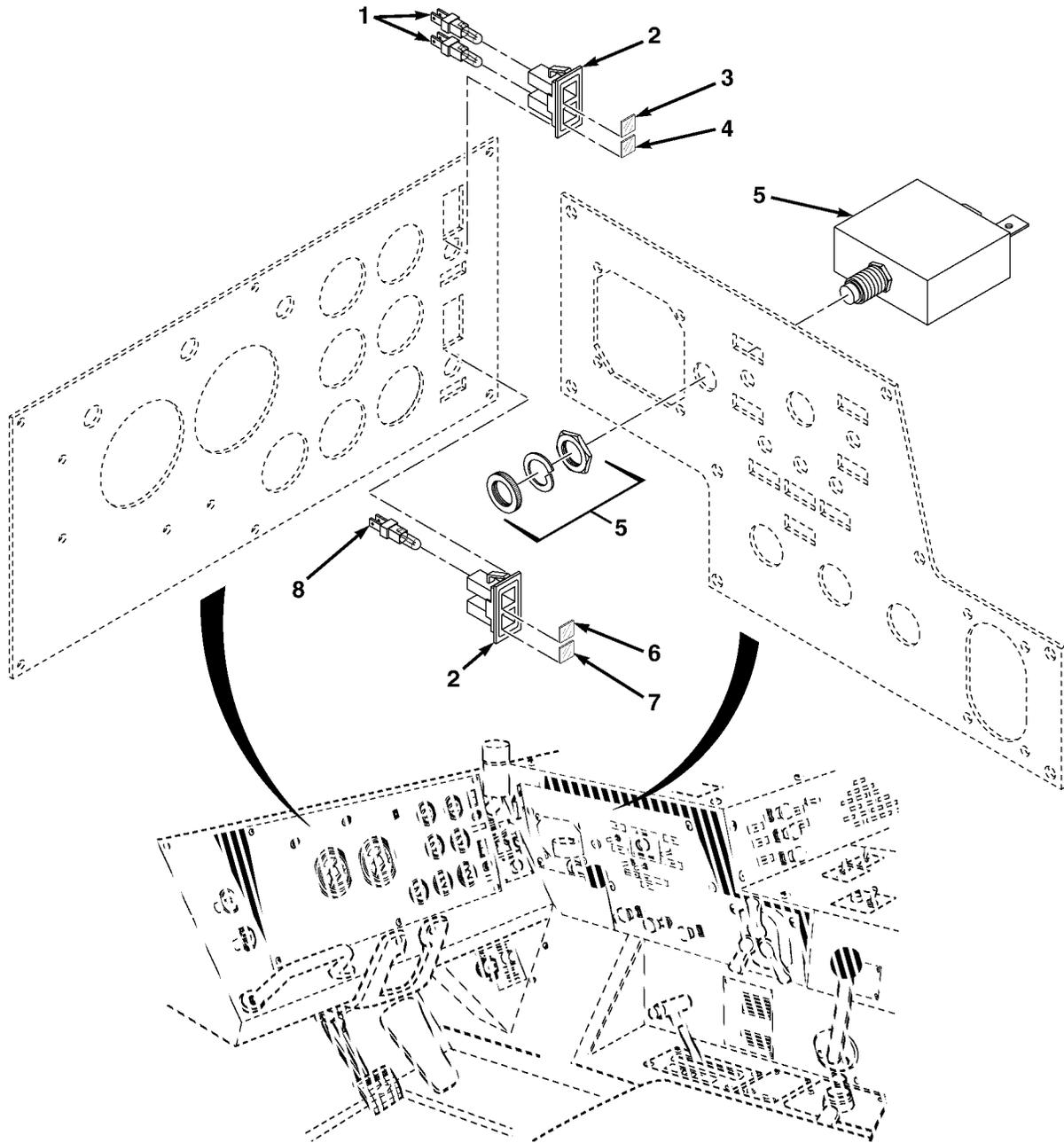

FIG. 2 CONTROL PANELS

SECTION II

TM 9-2320-304-14&P

(1) ITEM NO	(2) SMR CODE	(3) CAGEC CAGEC	(4) PART NUMBER	(5) DESCRIPTION AND USABLE ON CODES(UOC)	(6) QTY
GROUP 0607 INSTRUMENT OR ENGINE CONTROL PANEL FIG. 2 CONTROL PANELS					
1	PAOZZ	82484	E-013-004	BULB ASSY, AMBER	2
2	PAOZZ	82484	E-131-001	HOUSING,PILOT LAMP	2
3	PAOZZ	82484	59L.258	APPLIQUE,LHS NO TRA	1
4	PAOZZ	82484	59L.257	APPLIQUE,LHS OVERLO	1
5	PAOZZ	76374	1600-206-10032	CIRCUIT BREAKER	1
6	PAOZZ	82484	59L.261	APPLIQUE,LHS	1
7	PAOZZ	82484	596 620	APPLIQUE,BLACK SWIT	1
8	PAOZZ	82484	E-013-003	BULB ASSY, GREEN	1

END OF FIGURE

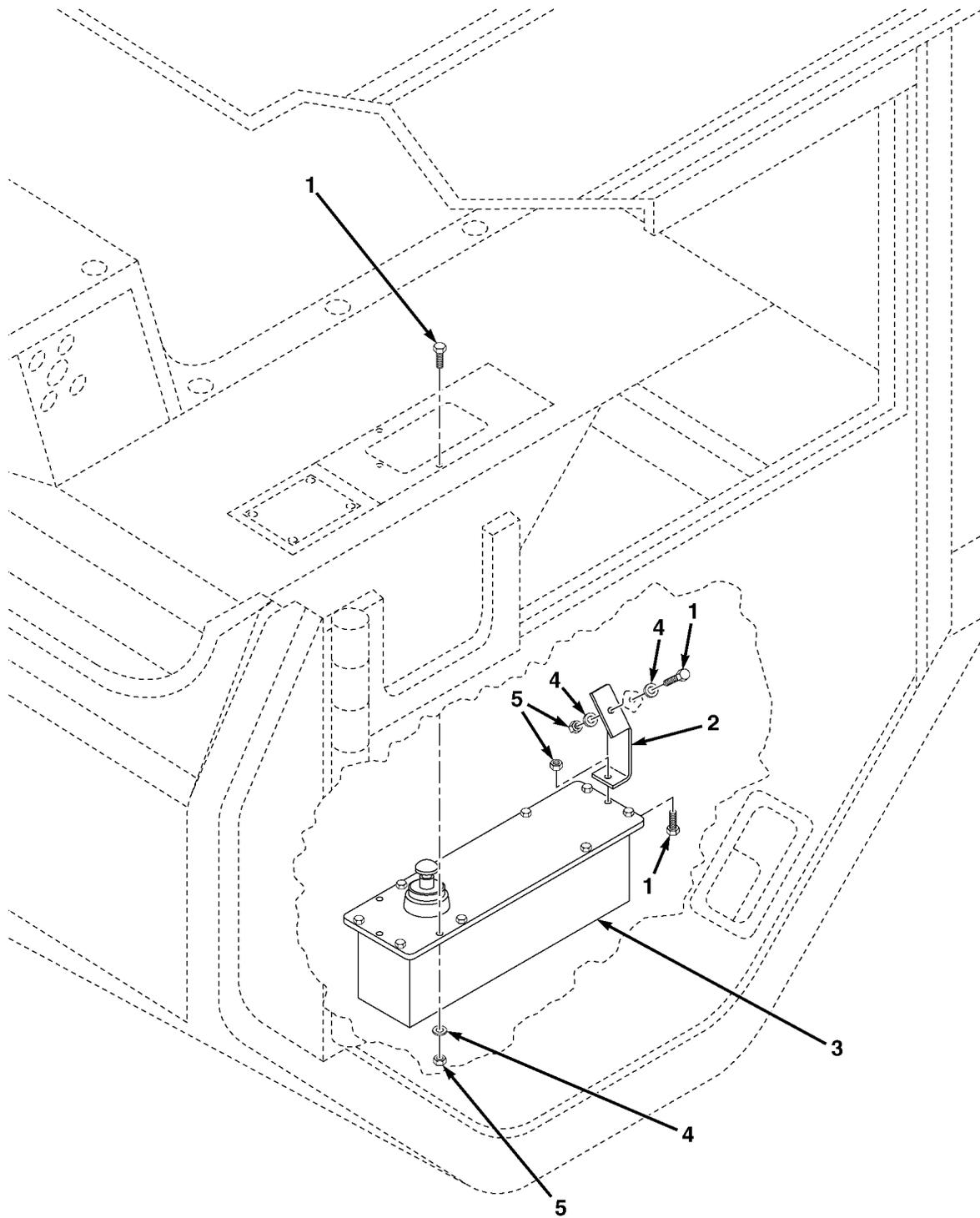

FIG. 3 LHS CONTROL ASSEMBLY

SECTION II

TM 9-2320-304-14&P

(1) ITEM NO	(2) SMR CODE	(3) CAGEC CAGEC	(4) PART NUMBER	(5) DESCRIPTION AND USABLE ON CODES(UOC)	(6) QTY
GROUP 0607 INSTRUMENT OR ENGINE CONTROL PANEL FIG. 3 LHS CONTROL ASSEMBLY					
1	PFOZZ	45152	59031AX	SCREW,MACHINE	5
2	PFOZZ	45152	3055018	BRACKET,DOUBLE ANGL	1
3	PAOZZ	0NYH2	D-191-7-1	CONTROL BOX,LHS	1
4	PFOZZ	45152	1379HX	WASHER,FLAT	5
5	PFOZZ	72962	22NM04	LOCKNUT, PAT	5

END OF FIGURE

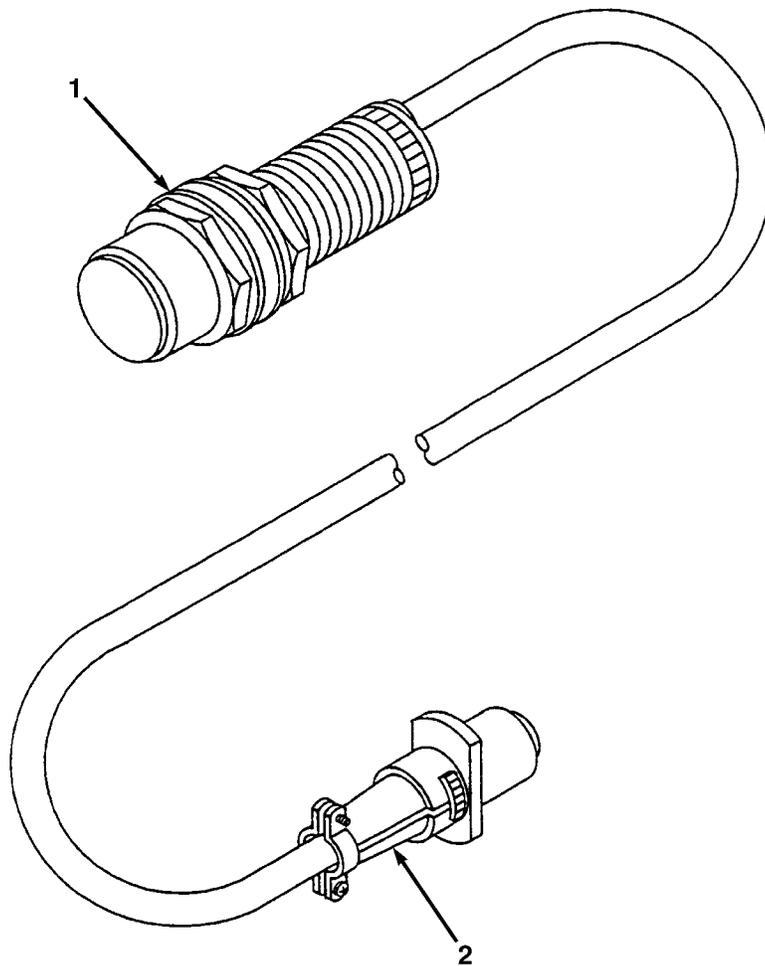

FIG. 4 LHS PROXIMITY SWITCH

SECTION II

TM 9-2320-304-14&P

(1) ITEM NO	(2) SMR CODE	(3) CAGEC CAGEC	(4) PART NUMBER	(5) DESCRIPTION AND USABLE ON CODES(UOC)	(6) QTY
GROUP 0608 MISCELLANEOUS ITEMS					
FIG. 4 LHS PROXIMITY SWITCH					
1	PFOZZ	52090	XS1M30PA370TF	SWITCH,PROXIMITY, HOOK ARM DOWN, 30 MM	1
2	PAOZZ	71468	CA3101F10SL-3PF8	CONNECTOR,PLUG	1

END OF FIGURE

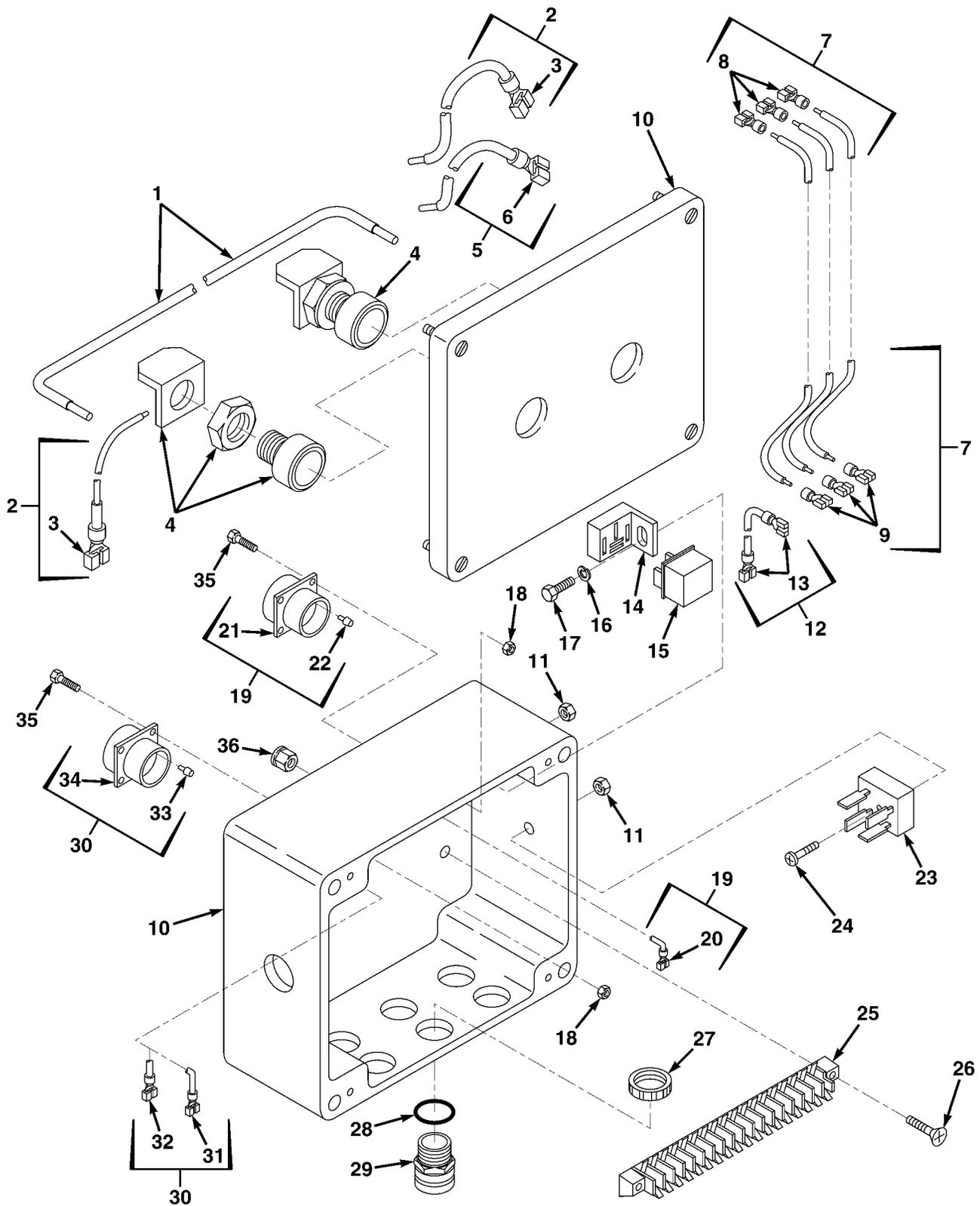

FIG. 5 MAIN JUNCTION BOX (LHS)

SECTION II

TM 9-2320-304-14&P

(1) ITEM NO	(2) SMR CODE	(3) CAGEC CAGEC	(4) PART NUMBER	(5) DESCRIPTION AND USABLE ON CODES(UOC)	(6) QTY
GROUP 0608 MISCELLANEOUS ITEMS					
FIG. 5 MAIN JUNCTION BOX (LHS)					
1	PFFZZ	45152	1949110	WIRE,JUMPER	1
2	MFOZZ	45152	3017872	WIRE ASSY MAKE FROM WIRE P/N 121782A (45152), 12 IN LG	2
2	MFOZZ	45152	3017871	WIRE ASSY MAKE FROM WIRE P/N 121782A (45152), 12 IN LG	2
3	PAFZZ	00779	41274	.TERMINAL,QDISC	1
4	PFOZZ	91929	1955680	SWITCH ASSY	2
5	MFOZZ	45152	3017873	WIRE ASSY MAKE FROM WIRE P/N 121782A (45152), 12 IN LG	1
6	PAFZZ	00779	41274	.TERMINAL,QDISC	1
7	MFOOO	45152	3017876	WIRE ASSY MAKE FROM WIRE P/N 121782A (45152), 12 IN LG	3
7	MFOOO	45152	3017875	WIRE ASSY MAKE FROM WIRE P/N 121782A (45152), 12 IN LG	3
7	MFOOO	45152	3017877	WIRE ASSY MAKE FROM WIRE P/N 121782A (45152), 12 IN LG	3
8	PAOZZ	00779	41274	.TERMINAL,QDISC	1
9	PAOZZ	00779	42282-2	.TERMINAL,FEMALE	1
10	PFFZZ	45152	1883410	BOX,JUNCTION	1
11	PAOZZ	78519	1571850	NUT,SELF-LOCKING, WASHE	2
12	MFOOO	45152	3017874	WIRE ASSY MAKE FROM WIRE P/N R-64932 (77060), 12 IN LG	1
13	PAOZZ	00779	41274	.TERMINAL,QDISC	2
14	PAFZZ	53867	3-334-485-008	SOCKET,ELEC COMP	1
15	PAOZZ	45152	1869500	RELAY,ELECTROMAG	1
16	PAFZZ	96906	MS45904-60	WASHER,LOCK	1
17	PAFZZ	96906	MS35206-264	SCREW,MACHINE	1
18	PAFZZ	78189	511-041810-01	NUT,SLFLKG,EW,HEX	8
19	PAFFF	45152	1883450	HARNES, LHS TO JUNC	1
20	PAFZZ	00779	41274	.TERMINAL,QDISC	10
21	PFOZZ	71468	CA3102R18-1S-F80	.CONNECTOR,RECEPTACL	1
22	PAOZZ	11139	114017	.PLUG,END SEAL, ELECT	1
23	PFOZZ	45152	1560090	RECTIFIER	1
24	PAOZZ	17566	45A115-P29	SCREW,MACHINE	1
25	PFFZZ	71400	A 203118-NL	STRIP,TERMINAL	1
26	PFFZZ	96906	MS35206-231	SCREW,MACHINE	2
27	PAOZZ	15235	141	LOCKNUT,ELECTRICAL	7
28	PAFZZ	56501	5262	RING,SEALING	7
29	PAFZZ	56501	SHC-1022	CONNECTOR,STRAIGHT	7
30	PAFFF	45152	1883440	HARNES,CAB TO JUNC	1
31	PAOZZ	00779	42282-2	.TERMINAL,FEMALE	1
32	PAOZZ	00779	41274	.TERMINAL,QDISC	15
33	PAOZZ	11139	114017	.PLUG,END SEAL, ELECT	1
34	PFOZZ	96906	MS3452W20-29S	.CONNECTOR	1
35	PAFZZ	45152	EE-105327	SCREW,MACHINE	8
36	PFFZZ	45152	1571870	NUT,HEX,WITH ASSEMB	2

END OF FIGURE

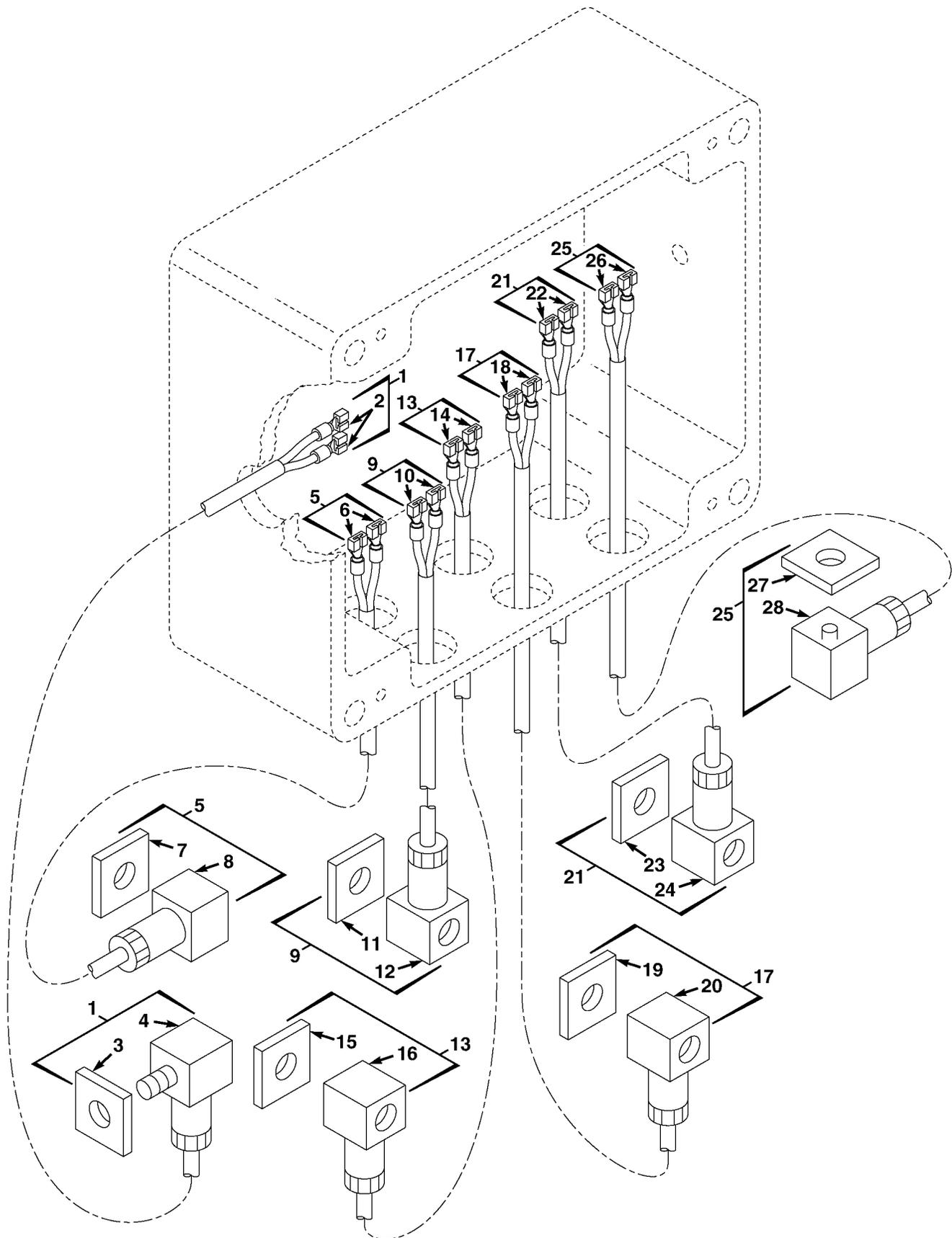

FIG. 6 MAIN JUNCTION BOX (LHS) WIRING HARNESS

SECTION II

TM 9-2320-304-14&P

(1) ITEM NO	(2) SMR CODE	(3) CAGEC CAGEC	(4) PART NUMBER	(5) DESCRIPTION AND USABLE ON CODES(UOC)	(6) QTY
GROUP 0608 MISCELLANEOUS ITEMS					
FIG. 6 MAIN JUNCTION BOX (LHS)					
WIRING HARNESS					
1	PBFFF	45152	1944310	HARNESS,PRESSURE	1
2	PAFZZ	00779	41274	.TERMINAL,QDISC	1
3	PAOZZ	0D5M6	731740-002	.GASKET	1
4	PAOZZ	0D5M6	931236-100	.CONNECTOR,PLUG, ELECT	1
5	PBFFF	45152	1877490	HARNESS,TRANSIT VAL	1
6	PAFZZ	00779	41274	.TERMINAL,QDISC	2
7	PAOZZ	0D5M6	731740-002	.GASKET	1
8	PAOZZ	0D5M6	931236-100	.CONNECTOR,PLUG, ELEC	1
9	PBFFF	45152	1877460	HARNESS,MAIN RAM	1
10	PAFZZ	00779	41274	.TERMINAL,QDISC	2
11	PAOZZ	0D5M6	731740-002	.GASKET	1
12	PAOZZ	0D5B6	931236-100	.CONNECTOR,PLUG, ELEC	1
13	PBFFF	45152	1877480	HARNESS,HOOK ARM	1
14	PAFZZ	00779	41274	.TERMINAL,QDISC	2
15	PAOZZ	0D5M6	731740-002	.GASKET	1
16	PAOZZ	0D5M6	931236-100	.CONNECTOR,PLUG, ELEC	1
17	PBFFF	45152	1877470	HARNESS,HOOK ARM	1
18	PAFZZ	00779	41274	.TERMINAL,QDISC	2
19	PAOZZ	0D5M6	731740-002	.GASKET	1
20	PAOZZ	0D5M6	931236-100	.CONNECTOR,PLUG, ELEC	1
21	PBFFF	45152	1877450	HARNESS,MAIN RAM	1
22	PAFZZ	00779	41274	.TERMINAL,QDISC	2
23	PAOZZ	0D5M6	731740-002	.GASKET	1
24	PAOZZ	0D5M6	931236-100	.CONNECTOR,PLUG, ELEC	1
25	PBFFF	45152	1877440	HARNESS,FRFLW	1
26	PAFZZ	00779	41274	.TERMINAL,QDISC	2
27	PAOZZ	0D5M6	731740-002	.GASKET	1
28	PAFZZ	0D5M6	931236-100	.CONNECTOR,PLUG, ELEC	1

END OF FIGURE

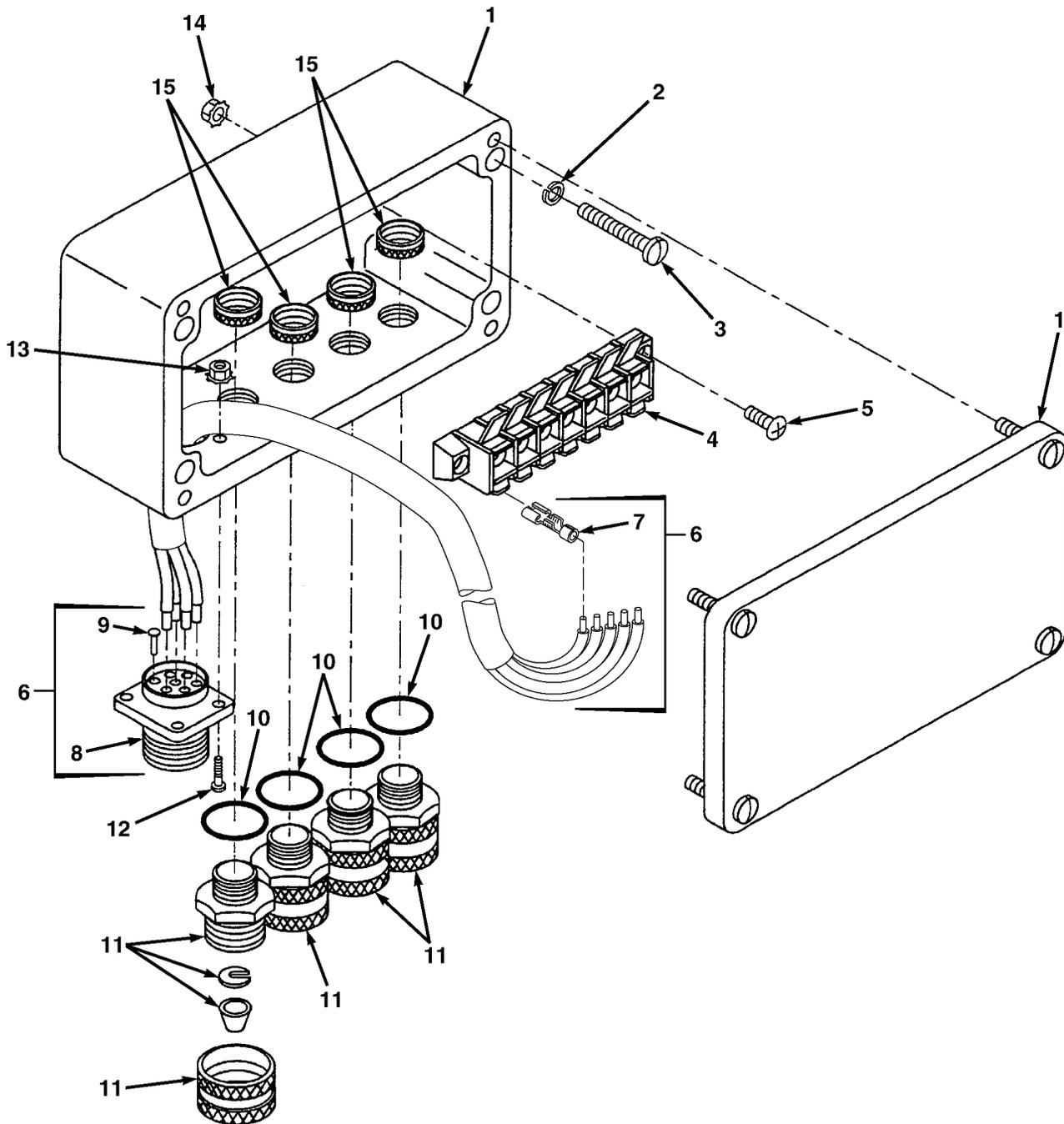

FIG. 7 JUNCTION BOX (LHS)

SECTION II

TM 9-2320-304-14&P

(1) ITEM NO	(2) SMR CODE	(3) CAGEC CAGEC	(4) PART NUMBER	(5) DESCRIPTION AND USABLE ON CODES(UOC)	(6) QTY
GROUP 0608 MISCELLANEOUS ITEMS					
FIG. 7 JUNCTION BOX (LHS)					
1	PFOZZ	45152	1891540	JUNCTION BOX	1
2	PAOZZ	35510	2434	WASHER, LOCK	4
3	PAOZZ	96906	MS51849-74	SCREW, MACHINE	4
4	PAOZZ	71400	A203107-NL	STRIP, TERMINAL	1
5	PFOZZ	96906	MS35206-231	SCREW, MACHINE	2
6	PFFFF	45152	1891410	LHS JUNCTION BOX HA	1
7	PAOZZ	00779	41274	.TERMINAL, QDISC	7
8	PFOZZ	71468	CA3102R18-1S-F80	.CONNECTOR, RECEPTACL	1
9	PAOZZ	11139	114017	.PLUG, END SEAL, ELECT	3
10	PAOZZ	56501	5262	RING, SEALING	4
11	PAOZZ	81922	SHC-1022	CONNECTOR, STRAIGHT	4
12	PAOZZ	45152	EE-105327	SCREW, MACHINE	4
13	PAOZZ	78189	511-041810-01	NUT, SLFLKG, EW, HEX	4
14	PFOZZ	45152	1571870	NUT, HEX, WITH ASSEMB	2
15	PAOZZ	15235	141	LOCKNUT, ELECTRICAL	4

END OF FIGURE

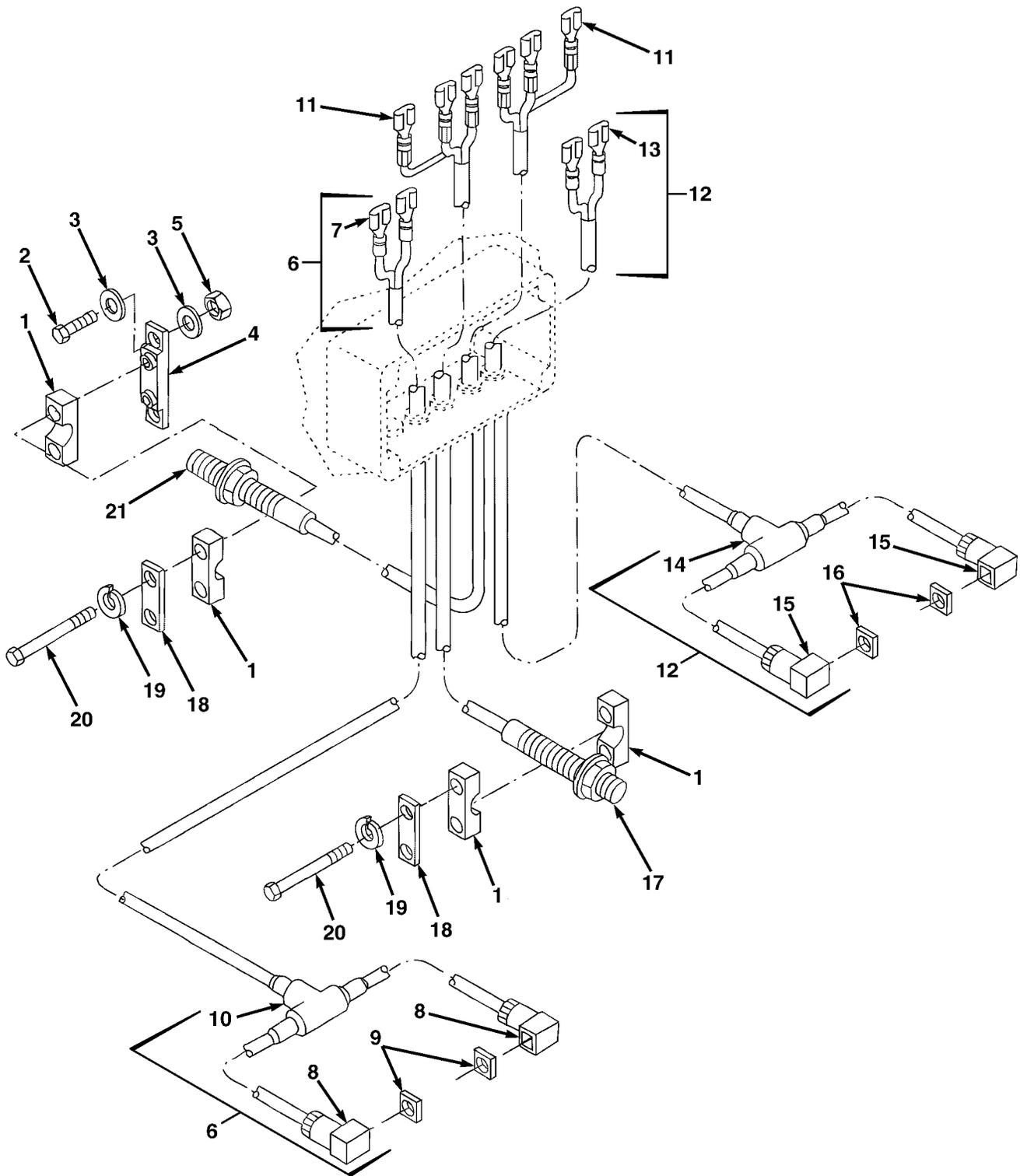

FIG. 8 JUNCTION BOX (LHS) WIRING HARNESS

SECTION II

TM 9-2320-304-14&P

(1) ITEM NO	(2) SMR CODE	(3) CAGEC CAGEC	(4) PART NUMBER	(5) DESCRIPTION AND USABLE ON CODES(UOC)	(6) QTY
GROUP 0608 MISCELLANEOUS ITEMS					
FIG. 8 JUNCTION BOX (LHS) WIRING HARNESS					
1	PFFZZ	53790	2180PA	CLAMP	2
2	PFFZZ	45152	66420AX	CAPSCREW,HEX HEAD	2
3	PAFZZ	96906	MS27183-10	WASHER,FLAT	2
4	PFFZZ	45152	1997520W	PLATE,PROXIMITY MOU	1
5	PAFZZ	72962	21NE-040	NUT,SELF-LOCKING,HE	2
6	PFFFF	45152	1878900	HARNESS,HOOK ARM, RH	1
7	PAOZZ	00779	41274	.TERMINAL,QDISC	2
8	PFOZZ	0D5M6	931236-100	.CONNECTOR,PLUG, ELEC	2
9	PAOZZ	0D5M6	731740-002	.GASKET	2
10	PFOZZ	06090	301A022-4/42	.BOOT,TEE	1
11	PAOZZ	00779	41274	TERMINAL,QDISC	6
12	PFFFF	45152	1878910	HARNESS,HOOK ARM, LH	1
13	PAOZZ	00779	41274	.TERMINAL,QDISC	2
14	PFOZZ	06090	301A022-4/42	.BOOT,TEE	1
15	PFOZZ	0D5M6	931236-100	.CONNECTOR,PLUG, ELEC	2
16	PAOZZ	0D5M6	731740-002	.GASKET	2
17	PFOZZ	52090	XS1M18PA370TF	SWITCH,PROXIMITY, HO HOOK ARM UP 18 MM	1
18	PFFZZ	53790	DP-2	COVERPLATE	2
19	PAFZZ	96906	MS35338-44	WASHER,LOCK	4
20	PFFZZ	45152	45092-AX	SCREW,CAP,HEX HEAD	4
21	PFOZZ	52090	XS1M18PA370TF	SWITCH,PROXIMITY, HO MAIN FRAME DOWN 18 MM	1

END OF FIGURE

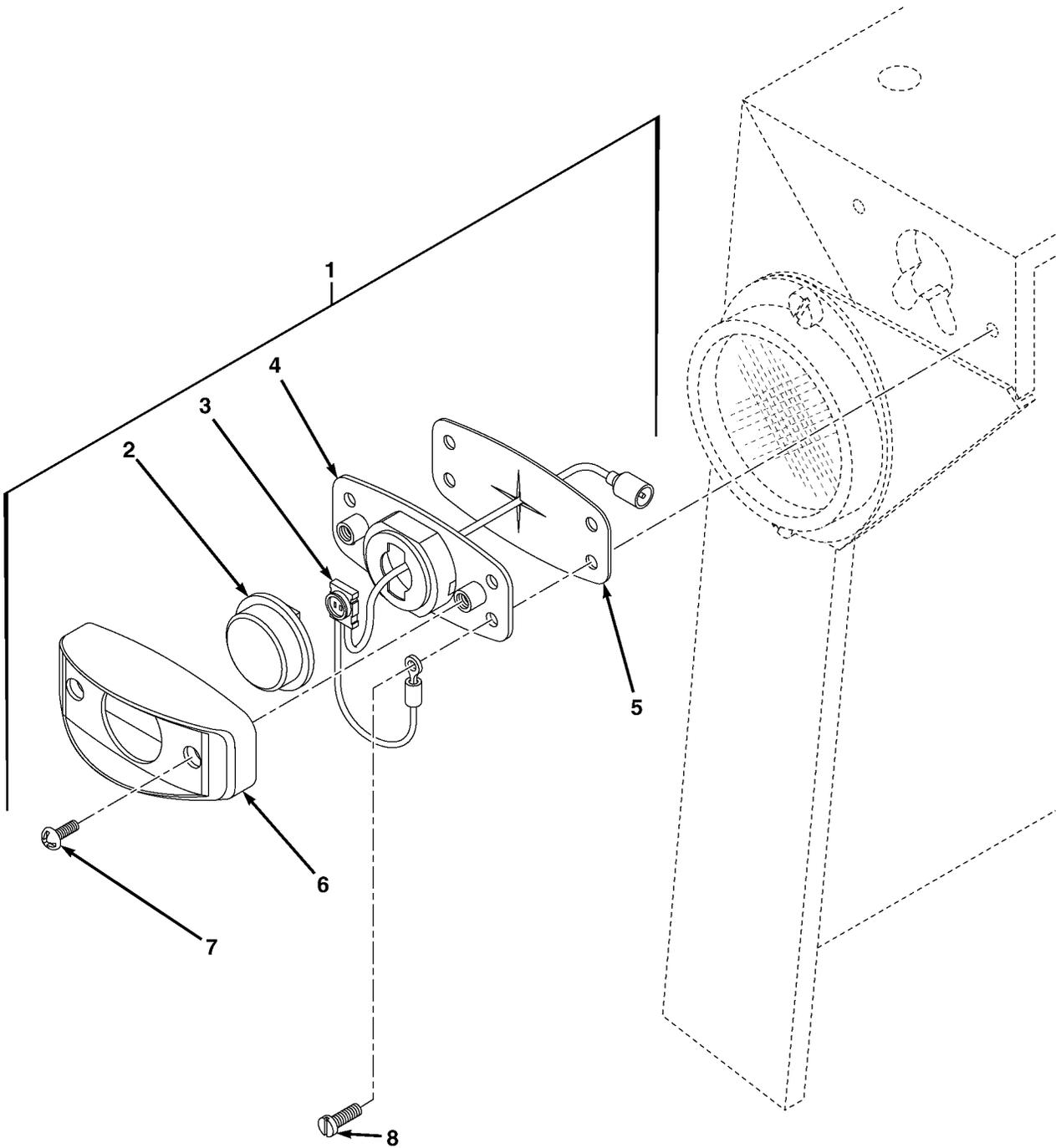

FIG. 9 CLEARANCE LIGHTS

SECTION II

TM 9-2320-304-14&P

(1) ITEM NO	(2) SMR CODE	(3) CAGEC CAGEC	(4) PART NUMBER	(5) DESCRIPTION AND USABLE ON CODES(UOC)	(6) QTY
GROUP 0609					
FIG. 9 CLEARANCE LIGHTS					
1	PAOOO	13548	07196	LIGHT,MARKER, CLEARANCE	1
2	PAOZZ	13548	30250Y	.DIODE,LIGHT EMITTIN	1
3	PFOZZ	13548	94626	.PIGTAIL	1
4	XAOZZ	13548	07197	.BASE,MOUNTING	1
5	PAOZZ	13548	5370	.GASKET,MOUNTING	1
6	XAOZZ	13548	07198	.BRACKET,OUTER	1
7	PAOZZ	96906	MS51958-64	.SCREW,MACHINE	2
8	PAOZZ	93907	B71-10015-002	SCREW,TAPPING	8

END OF FIGURE

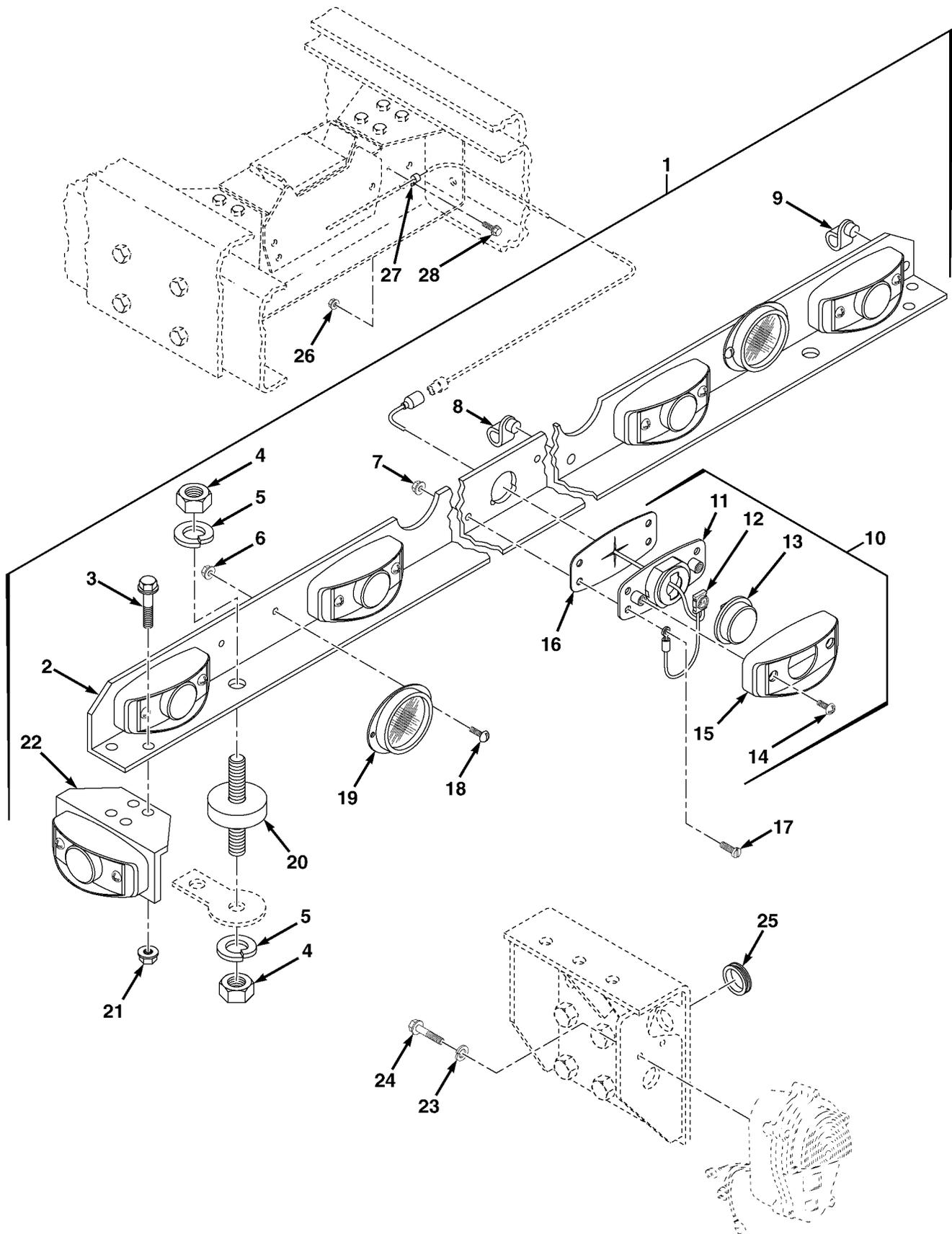

FIG. 10 REAR LIGHT BAR ASSEMBLY

SECTION II

TM 9-2320-304-14&P

(1) ITEM NO	(2) SMR CODE	(3) CAGEC CAGEC	(4) PART NUMBER	(5) DESCRIPTION AND USABLE ON CODES(UOC)	(6) QTY
GROUP 0609					
FIG. 10 REAR LIGHT BAR ASSEMBLY					
1	PAOOO	45152	3153166	LIGHT BAR ASSEMBLY, REAR	1
2	PAOZZ	45152	3154864	.BRACKET, ANGLE	1
3	PAOZZ	45152	1606140	.SCREW, CAP, HEX HEAD	4
4	PAOZZ	45152	434-A	.NUT, HEX HEAD	4
5	PAOZZ	45152	351AX	.WASHER, LOCK	4
6	PAOZZ	72962	21NE-040	.NUT, SELF-LOCKING, HE	4
7	PAOZZ	45152	1571850	.NUT, SELF-LOCKING, WASHE	14
8	PAOZZ	83014	H360K2598	.CLAMP, LOOP	4
9	PAOZZ	83014	H360-6-2	.CLAMP, LOOP	2
10	PAOZZ	13548	07195	.LIGHT, MARKER, CLEARA	7
11	XAOZZ	13548	07197	..BASE, MOUNTING	1
12	PFOZZ	13548	94626	..PIGTAIL	1
13	PAOZZ	13548	30250Y	..DIODE, LIGHT EMITTING	1
14	PAOZZ	96906	MS51958-64	..SCREW, MACHINE	2
15	XAOZZ	13548	07198	..BRACKET, OUTER	1
16	PAOZZ	13548	5370	..GASKET, MOUNTING	1
17	PAOZZ	45152	59031AX	.SCREW, MACHINE	14
18	PAOZZ	45152	1434HX	.SCREW, MACHINE	4
19	PAOZZ	96906	MS35387-1	.REFLECTOR, RED	2
20	PAOZZ	42366	16282B-35005	.MOUNT	2
21	PAOZZ	45152	1600460	.NUT, HEX	4
22	PAOZZ	45152	1867670	.BRACKET, LIGHT	2
23	PAOZZ	96906	MS45904-76	WASHER, LOCK	4
24	PAOZZ	96906	MS35295-60	SCREW, CAP, HEX	4
25	PAOZZ	70485	559	RUBBER GROMMET	2
26	PAOZZ	45152	1600460	NUT, HEX	1
27	PAOZZ	75272	COV-0713	CLAMP, LOOP, CUSHIONED	1
28	PAOZZ	45154	1754140	SCREW, CAP, HEX HEAD	1

END OF FIGURE

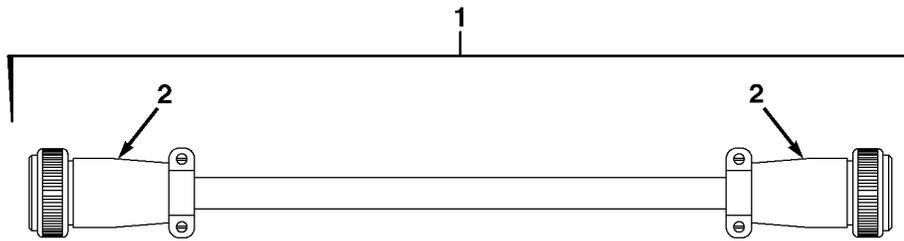

FIG. 11 CAB TO BULKHEAD HARNESS

SECTION II

TM 9-2320-304-14&P

(1) ITEM NO	(2) SMR CODE	(3) CAGEC CAGEC	(4) PART NUMBER	(5) DESCRIPTION AND USABLE ON CODES(UOC)	(6) QTY
				GROUP 0613 HULL OR CHASSIS WIRING HARNESS FIG. 11 CAB TO BULKHEAD HARNESS	
1	PAFOO	45152	1860800	CAB TO BULKHEAD HAR	1
2	PAOZZ	61468	CA3106F20-29S-F8	.CONNECTOR	2

END OF FIGURE

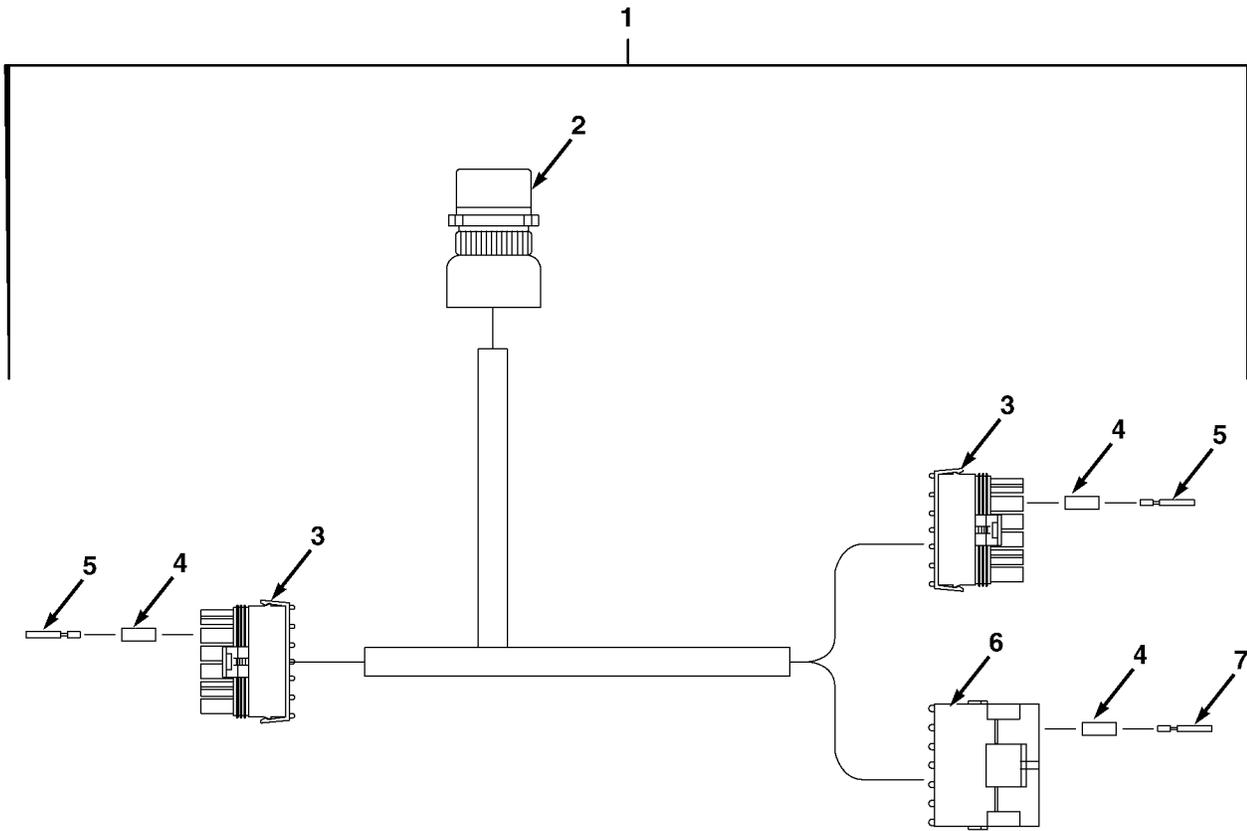

FIG. 12 CAB TO INTERFACE WIRING HARNESS

SECTION II

TM 9-2320-304-14&P

(1) ITEM NO	(2) SMR CODE	(3) CAGEC CAGEC	(4) PART NUMBER	(5) DESCRIPTION AND USABLE ON CODES(UOC)	(6) QTY
-------------------	--------------------	-----------------------	-----------------------	---	------------

GROUP 0613 HULL OR CHASSIS WIRING HARNESS
FIG. 12 CAB TO INTERFACE WIRING HARNESS

1	PAFOO	45152	1860810	HARNESS,CAB TO INTERFACE	1
2	PAOZZ	71468	CA3100R20-29PF80	.CONNECTOR	1
3	PAOZZ	77060	12015799	.CONNECTOR,PLUG, ELEC	2
4	PAOZZ	77060	12015323	.BOOT,DUCT	18
5	PAOZZ	77060	12034051	.TERMINAL	12
6	PAOZZ	12603	2775859	.CONNECTOR,PLUG, ELEC	1
7	PAOZZ	45152	1624120	.TERMINAL,MALE	6

END OF FIGURE

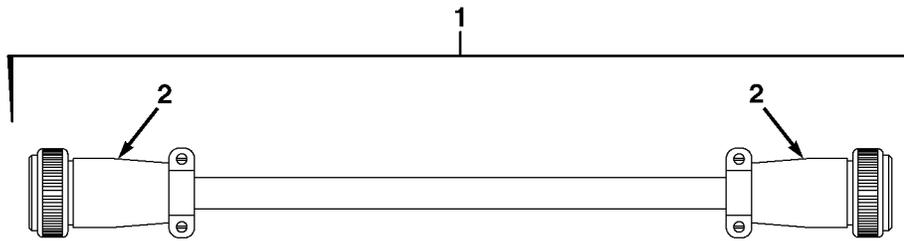

FIG. 13 CAB TO JUNCTION BOX WIRING HARNESS

SECTION II

TM 9-2320-304-14&P

(1) ITEM NO	(2) SMR CODE	(3) CAGEC CAGEC	(4) PART NUMBER	(5) DESCRIPTION AND USABLE ON CODES(UOC)	(6) QTY
				GROUP 0613 HULL OR CHASSIS WIRING HARNESS FIG. 13 CAB TO JUNCTION BOX WIRING HARNESS	
1	PAOFF	45152	1860790	HARNESS,CAB TO JB	1
2	PAOZZ	96906	MS3456W20-29P	.CONNECTOR	2

END OF FIGURE

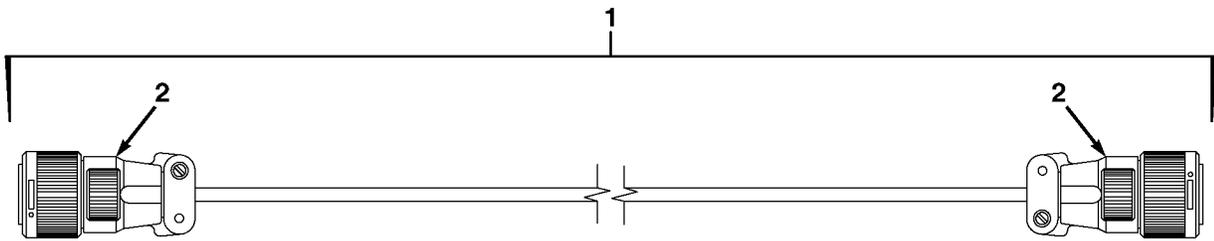

FIG. 14 JUNCTION BOX TO LHS WIRING HARNESS

SECTION II

TM 9-2320-304-14&P

(1) ITEM NO	(2) SMR CODE	(3) CAGEC CAGEC	(4) PART NUMBER	(5) DESCRIPTION AND USABLE ON CODES(UOC)	(6) QTY
GROUP 0613 HULL OR CHASSIS WIRING HARNESS FIG. 14 JUNCTION BOX TO LHS WIRING HARNESS					
1	PAFOO	45152	1860780	HARNESS,JB TO LHS	1
2	PAOZZ	71468	CA3106F18-1PF80	.CONNECTOR	2

END OF FIGURE

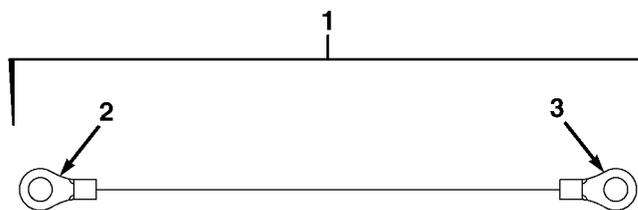

FIG. 15 WIRE ASSEMBLY

SECTION II

TM 9-2320-304-14&P

(1) ITEM NO	(2) SMR CODE	(3) CAGEC CAGEC	(4) PART NUMBER	(5) DESCRIPTION AND USABLE ON CODES(UOC)	(6) QTY
GROUP 0613 HULL OR CHASSIS WIRING HARNESS FIG. 15 WIRE ASSEMBLY					
1	PAOOO	45152	3060685	WIRE ELECTRICAL	1
2	PAOZZ	96906	MS25036-158	.TERMINAL,RING	1
3	PAOZZ	96906	MS25036-118	.TERMINAL,RING	1

END OF FIGURE

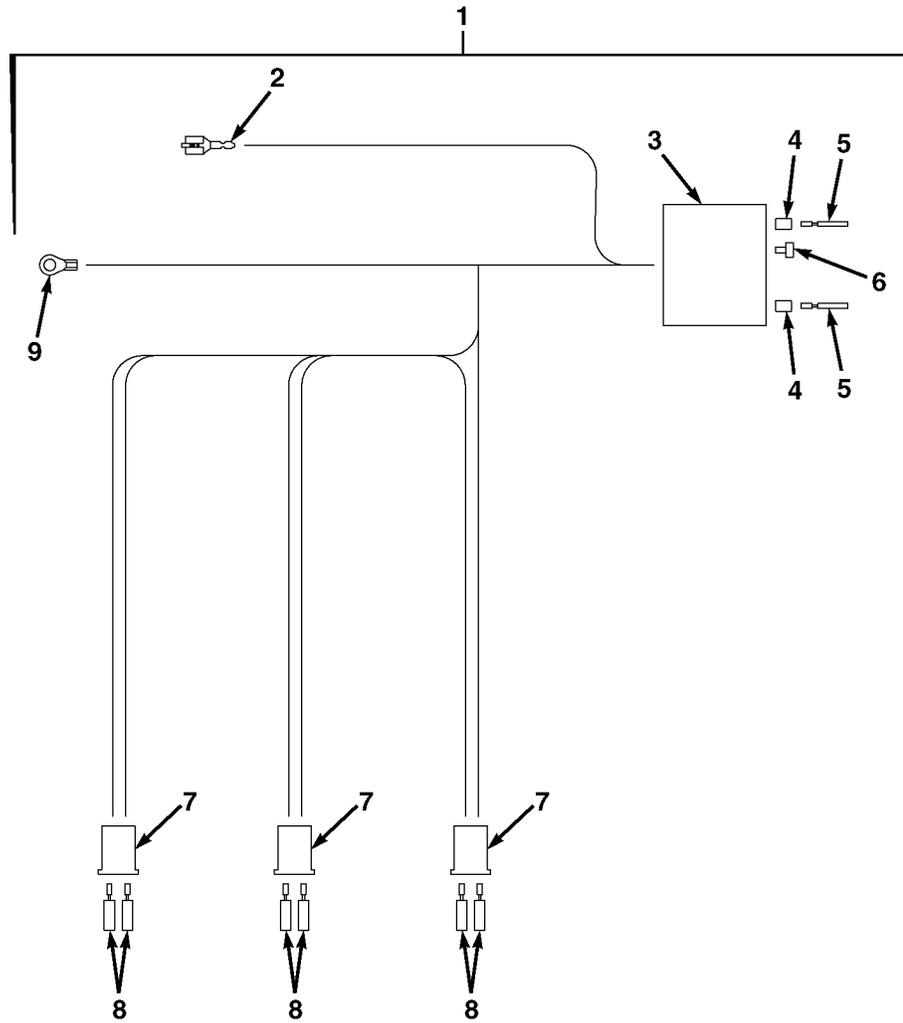

FIG. 16 WIRE ASSEMBLY

SECTION II

TM 9-2320-304-14&P

(1) ITEM NO	(2) SMR CODE	(3) CAGEC CAGEC	(4) PART NUMBER	(5) DESCRIPTION AND USABLE ON CODES(UOC)	(6) QTY
GROUP 0613 HULL OR CHASSIS WIRING HARNESS FIG. 16 WIRE ASSEMBLY					
1	PAFOO	45152	3060686	WIRING HARNESS, BRAN	1
2	PAOZZ	00779	341002-6	.TERMINAL, QUICK DIS	1
3	PAOZZ	12603	2775859	.CONNECTOR, PLUG, ELEC	1
4	PAOZZ	77060	12015193	.CABLE, SEAL	2
5	PAOZZ	77060	12089305	.TERMINAL	2
6	PAOZZ	77060	12010300	.PLUG, CABLE	4
7	PAOZZ	82484	913328	.SOCKET, HOUSING	3
8	PAOZZ	00779	42282-2	.TERMINAL, FEMALE	6
9	PAOZZ	96906	MS25036-158	.TERMINAL, RING	1

END OF FIGURE

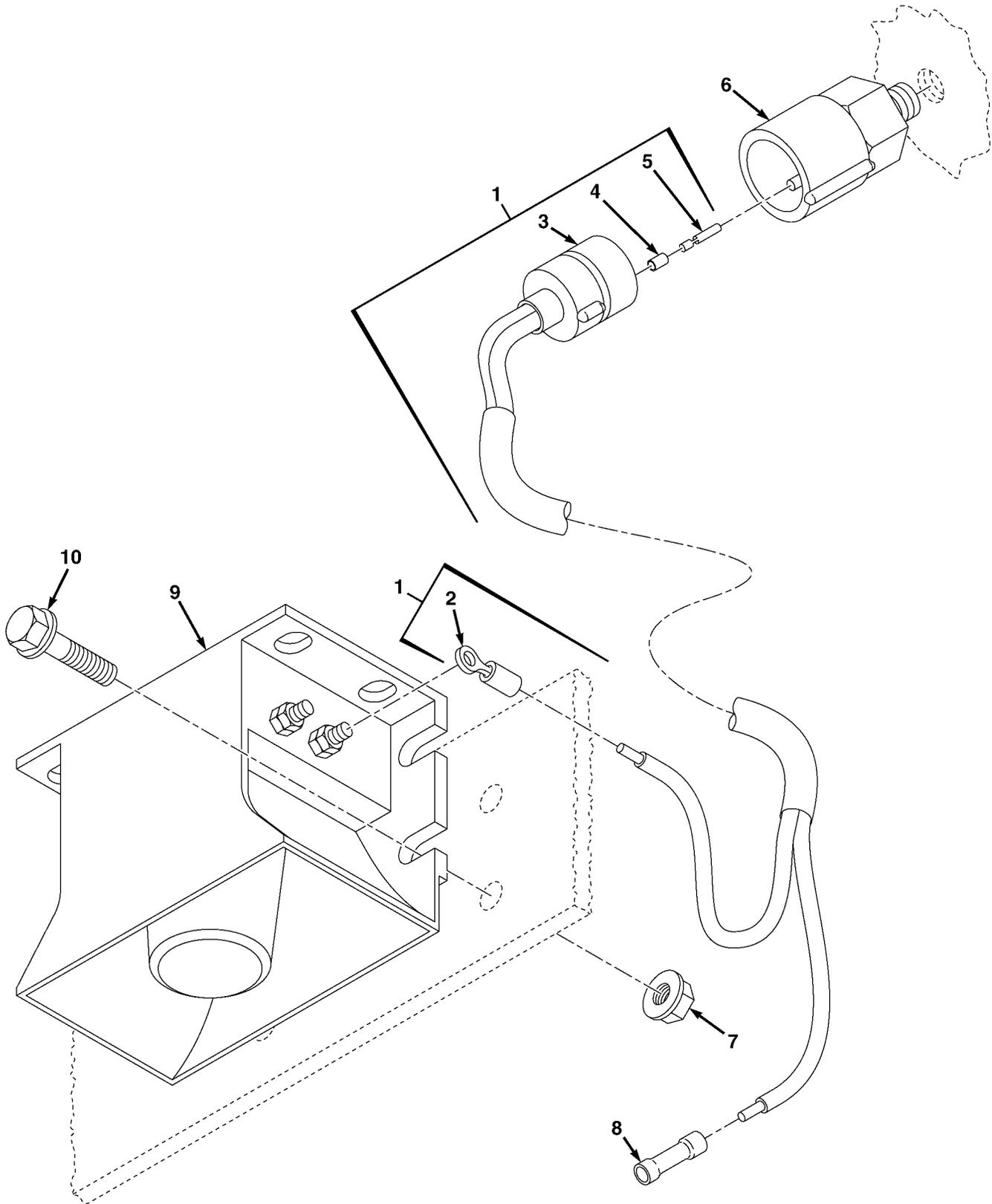

FIG. 17 BACKUP ALARM HARNESS

SECTION II

TM 9-2320-304-14&P

(1) ITEM NO	(2) SMR CODE	(3) CAGEC CAGEC	(4) PART NUMBER	(5) DESCRIPTION AND USABLE ON CODES(UOC)	(6) QTY
GROUP 0613 HULL OR CHASSIS WIRING HARNESS					
FIG. 17 BACKUP ALARM HARNESS					
1	PAFOO	45152	3061973	HARNESS, REVERSE ALA	1
2	PAOZZ	96906	MS25036-118	.TERMINAL, RING	1
3	PAOZZ	19207	7064586	.PLUG	1
4	PAOZZ	77060	297002	.SLEEVE	2
5	PAOZZ	24617	2965639	.TERMINAL ASSEMBLY	2
6	PAOZZ	58723	S-1733-1500	SWITCH, BACKUP LIGHT	1
7	PAOZZ	45152	1600460	NUT, FLG, HEX	4
8	PAOZZ	00779	327025	CONNECTOR, BUTT	1
9	PAOZZ	57013	688411-4	ALARM, BACK-UP	1
10	PAOZZ	45152	1754140	SCREW, CAP, HEX HEAD	4

END OF FIGURE

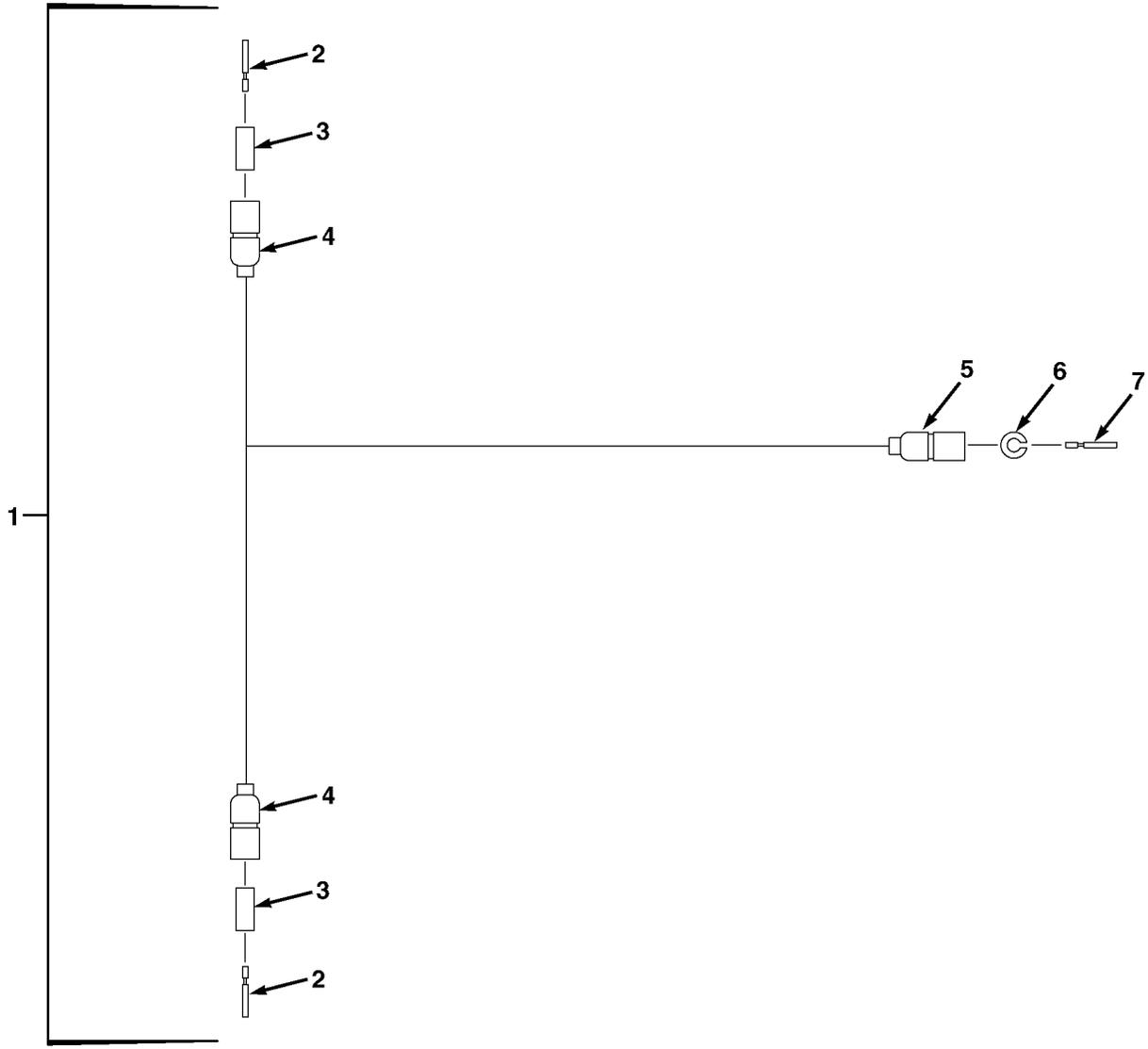

FIG. 18 SIDE CLEARANCE LIGHT HARNESS

SECTION II

TM 9-2320-304-14&P

(1) ITEM NO	(2) SMR CODE	(3) CAGEC CAGEC	(4) PART NUMBER	(5) DESCRIPTION AND USABLE ON CODES(UOC)	(6) QTY
GROUP 0613 HULL OR CHASSIS WIRING HARNESS					
FIG. 18 SIDE CLEARANCE LIGHT HARNESS					
1	PAFOO	45152	3055130	WIRING HARNESS, BRAN	1
2	PAOZZ	19207	8338564	.TERMINAL ASSEMBLY	2
3	PAOZZ	19207	8338562	.INSULATOR, BUSHING	2
4	PAOZZ	19207	8724494	.CABLE NIPPLE, ELECTR	2
5	PAOZZ	97403	13207E6498-2	.SHELL, ELECTRICAL CO	1
6	PAOZZ	19207	8338567	.WASHER, SLOTTED	1
7	PAOZZ	19204	572929	.CONTACT, ELECTRICAL	1

END OF FIGURE

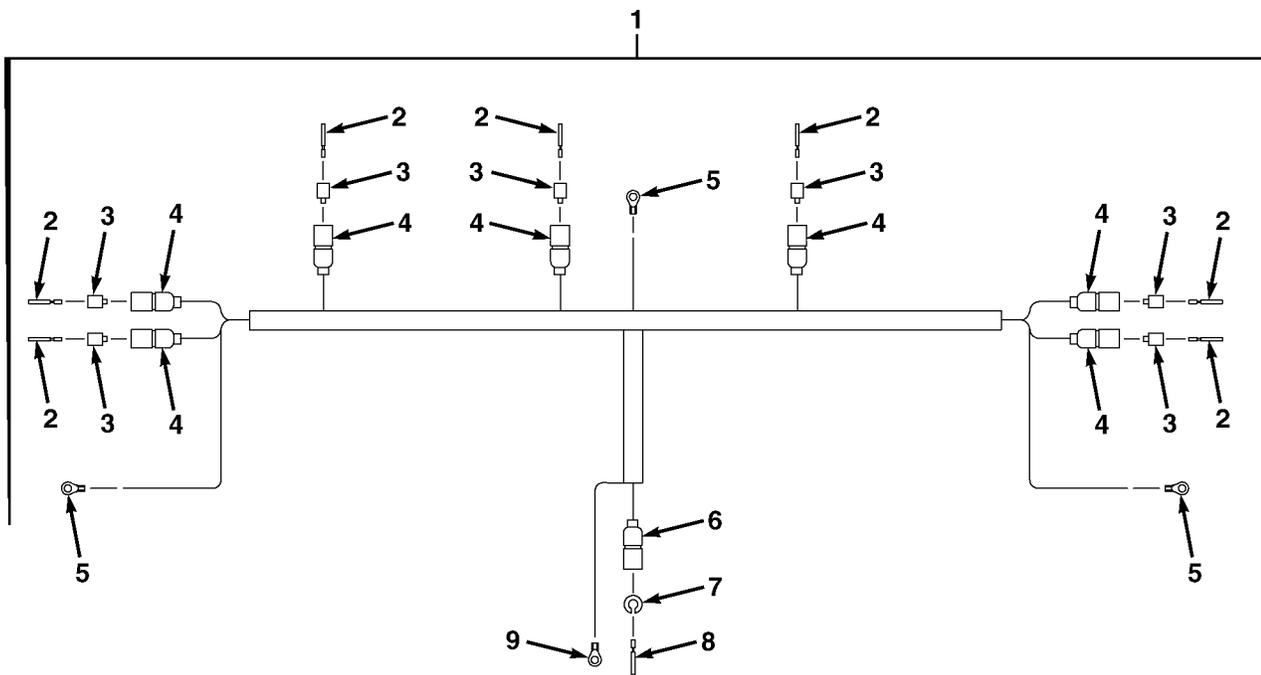

FIG. 19 CLEARANCE LIGHT HARNESS, REAR

SECTION II

TM 9-2320-304-14&P

(1) ITEM NO	(2) SMR CODE	(3) CAGEC CAGEC	(4) PART NUMBER	(5) DESCRIPTION AND USABLE ON CODES(UOC)	(6) QTY
GROUP 0613 HULL OR CHASSIS WIRING HARNESS FIG. 19 CLEARANCE LIGHT HARNESS, REAR					
1	PAFOO	45152	3276347	WIRING HARNESS BRAN	1
2	PAOZZ	19207	8338564	.TERMINAL ASSEMBLY	7
3	PAOZZ	19207	8338562	.INSULATOR,BUSHING	7
4	PAOZZ	19207	8724494	.PLUG CABLE NIPPLE, ELECTR	7
5	PAOZZ	96906	MS25036-158	.TERMINAL,RING	3
6	PAOZZ	97403	13207E6498-2	.SHELL,ELECTRICAL CO	1
7	PAOZZ	19207	8338567	.WASHER,SLOTTED	1
8	PAOZZ	96906	MS27148-2	.TERMINAL	1
9	PAOZZ	96906	MS25036-113	.TERMINAL,LUG	1

END OF FIGURE

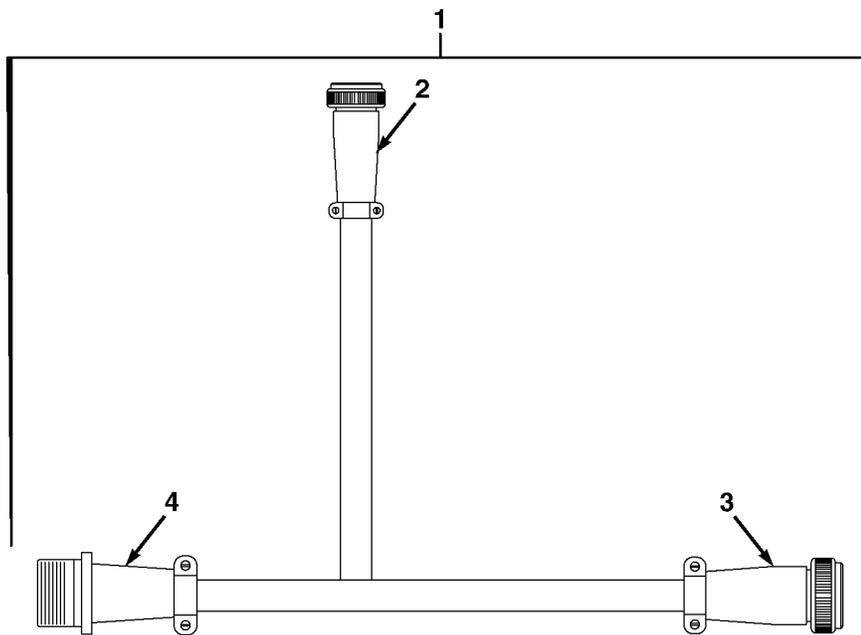

FIG. 20 LHS MAIN WIRING HARNESS

SECTION II

TM 9-2320-304-14&P

(1)	(2)	(3)	(4)	(5)	(6)
ITEM	SMR		PART		
NO	CODE	CAGEC	NUMBER	DESCRIPTION AND USABLE ON CODES(UOC)	QTY

GROUP 0613 HULL OR CHASSIS WIRING HARNESS
 FIG. 20 LHS MAIN WIRING HARNESS

1	PAFOO	45152	1860820	HARNESS,MAIN LHS	1
2	PAOZZ	71468	CA3106F10SL3SF80	.CONNECTOR	1
3	PAOZZ	71468	CA3106F18-1PF80	.CONNECTOR	1
4	PAOZZ	71468	CA3100F18-1SF80	.CONNECTOR	1

END OF FIGURE

SECTION II

TM 9-2320-304-14&P

(1) ITEM NO	(2) SMR CODE	(3) CAGEC CAGEC	(4) PART NUMBER	(5) DESCRIPTION AND USABLE ON CODES(UOC)	(6) QTY
GROUP 15 FRAME TOWING ATTACHMENTS, DRAWBARS, AND ARTICULATION SYSTEMS					
GROUP 1501 FRAME ASSEMBLY					
FIG. 21 LHS ROLLER AND ROLLER MOUNTING BRACKET					
1	PAOZZ	11929	93544216	SCREW,CAP,HEX HEAD	8
2	PAOZZ	45152	354AX	WASHER,LOCK	8
3	PFOZZ	45152	1862350	PLATE,LOCK	4
4	PFOZZ	45152	1862360	PLATE,END	2
5	PFOZZ	45152	3SK804	ROLLER,HORIZONTAL	2
6	PFOZZ	45152	1953740	BRACKET,DATA PLATE	2
7	PAOZZ	45152	738HX4	SCREW,CAP,HEX HEAD	8
8	PAOZZ	45152	355AX	WASHER,LOCK	8
9	PFOZZ	45152	3SK805	ROLLER ANGLED	2
10	PFOZZ	2K272	W08	WASHER,LOCK	2
11	PFOZZ	2K272	N08	NUT,LOCK	2
12	PFOZZ	45152	1862340	WASHER,THRUST	2
13	PFOZZ	2K272	W09	WASHER,KEY	2
14	PFOZZ	2K272	N09	NUT,LOCK	2
15	PBOZZ	45152	1862230W	BRACKET,HORIZONTAL	1

END OF FIGURE

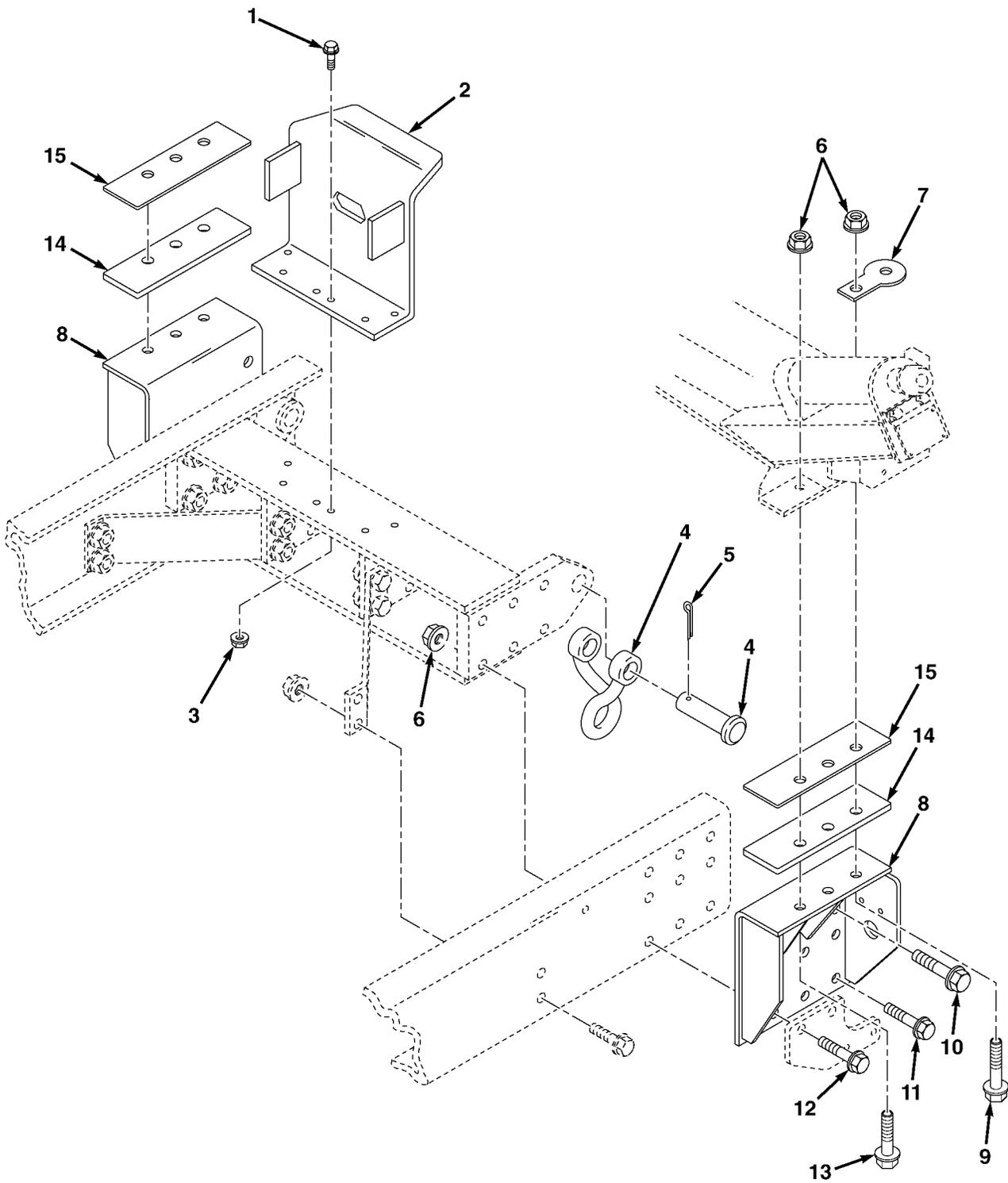

FIG. 22 REAR ROLLER MOUNTING ASSEMBLY

SECTION II

TM 9-2320-304-14&P

(1) ITEM NO	(2) SMR CODE	(3) CAGEC CAGEC	(4) PART NUMBER	(5) DESCRIPTION AND USABLE ON CODES(UOC)	(6) QTY
GROUP 1501 FRAME ASSEMBLY					
FIG. 22 REAR ROLLER MOUNTING ASSEMBLY					
1	PAOZZ	45152	128131A	SCREW,CAP, HEXAGON H	6
2	PAOZZ	45152	3053453	BRACKET,DOUBLE ANGL	1
3	PAOZZ	45152	110310A	NUT,SELF-LOCKING, EW	6
4	PAOZZ	90202	M885AG	SHACKLE	2
5	PAOZZ	96906	MS24665-717	COTTER PIN	2
6	PAOZZ	45152	110312A	NUT,SELF-LOCKING, EW	26
7	PFOZZ	45152	3055925	BRACKET,MOUNTING	2
8	PAOZZ	45152	3051989	BRACKET,MULTIPLE AN	1
8	PAOZZ	45152	3051990	BRACKET,MULTIPLE AN	1
9	PAOZZ	45152	126536A	SCREW,CAP, FLANGED	2
10	PAOZZ	45152	111320A	SCREW,CAP, FLANGED	14
11	PAOZZ	52167	WE1030TB	SCREW,CAP, FLANGED	4
12	PAOZZ	45152	1317120	SCREW,CAP, FLANGED	8
13	PAOZZ	45152	1324980	SCREW,CAP, FLANGED	4
14	PAOZZ	45152	3053912	SPACER,PLATE	2
15	PAOZZ	45152	3055128	SPACER,PLATE ROLLER	2

END OF FIGURE

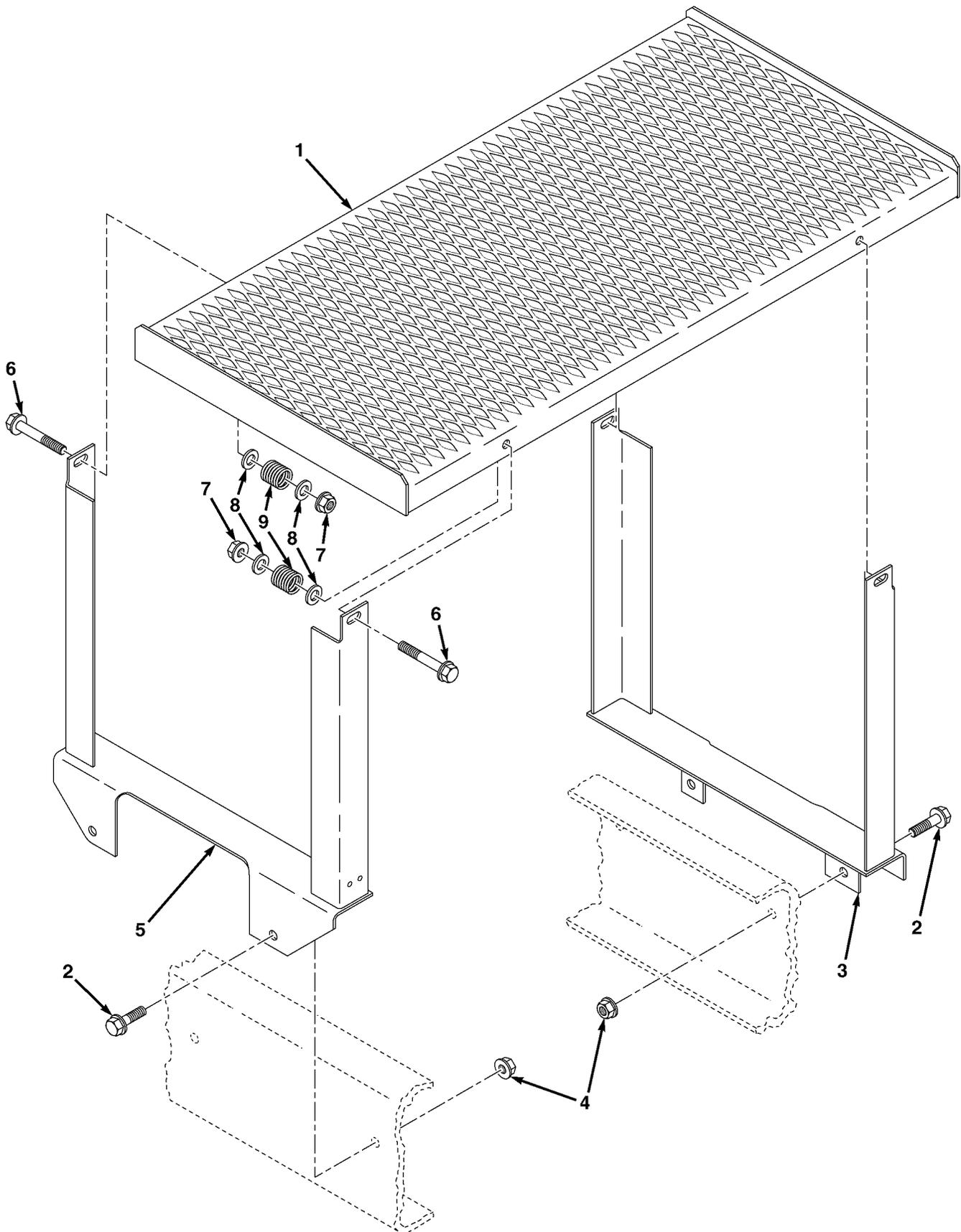

FIG. 23 PLATFORM ASSEMBLY

SECTION II

TM 9-2320-304-14&P

(1) ITEM NO	(2) SMR CODE	(3) CAGEC CAGEC	(4) PART NUMBER	(5) DESCRIPTION AND USABLE ON CODES(UOC)	(6) QTY
GROUP 1501 FRAME ASSEMBLY					
FIG. 23 PLATFORM ASSEMBLY					
1	PAFZZ	45152	1971460W	DECK ASSY	1
2	PAFZZ	52167	WE0818TB	SCREW, FLANGED, HEX	4
3	PAFZZ	45152	3054537	BRACKET, MOUNTING	1
4	PAFZZ	45152	110311A	NUT, FLANGED, HEX	4
5	PAFZZ	45152	3054536	BRACKET, MOUNTING	1
6	PAFZZ	52167	WE0628TB	SCREW, FLANGE, CAP	4
7	PAFZZ	45152	110310A	NUT, SELF-LOCKING, EX	4
8	PAFZZ	45152	720HX	WASHER, FLAT	8
9	PAFZZ	45152	1307840	SPRING	4

END OF FIGURE

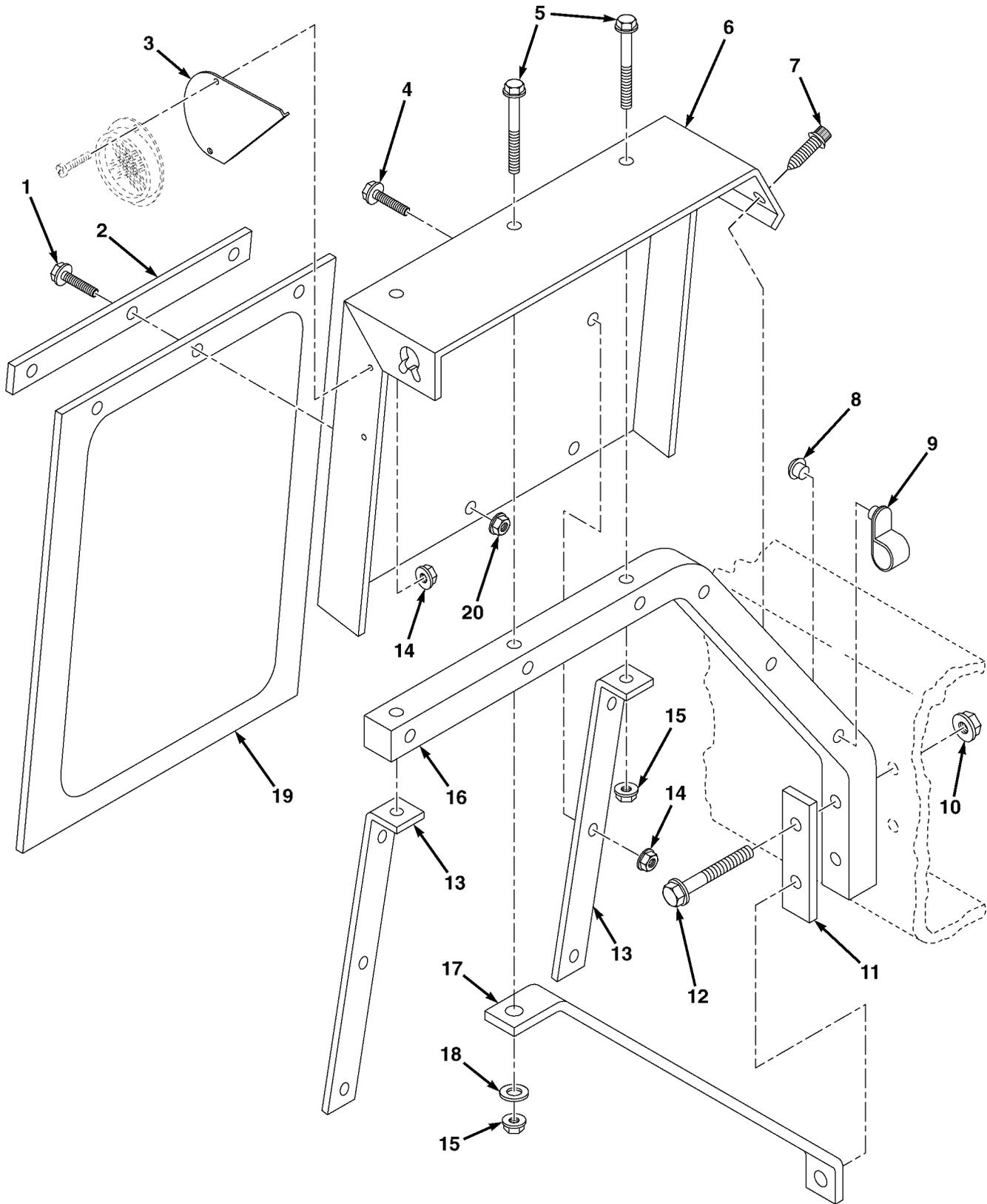

FIG. 24 REAR FENDER ASSEMBLY

SECTION II

TM 9-2320-304-14&P

(1) ITEM NO	(2) SMR CODE	(3) CAGEC CAGEC	(4) PART NUMBER	(5) DESCRIPTION AND USABLE ON CODES(UOC)	(6) QTY
				GROUP 18 BODY, CAB, HEAD, AND HULL GROUP 1802 FENDERS, RUNNING BOARDS WITH MOUNTING PARTS, ATTACHING PARTS, WINDSHIELD, GLASS, ETC. FIG. 24 REAR FENDER ASSEMBLY	
1	PAOZZ	45152	1754220	SCREW,CAP,HEX	6
2	PAOZZ	45152	1330560	PLATE,CLAMPING	2
3	PAOZZ	45152	1976560	RH REFLECTOR BRACKET	1
3	PAOZZ	45152	1976570	LH REFLECTOR BRACKET	1
4	PAOZZ	45152	1606140	SCREW,CAP,HEX HD	8
5	PFOZZ	45152	1754300	SCREW,CAP,HEX HD	6
6	PFOZZ	45152	1783090	FENDER,REAR,RH SIDE	1
6	PFOZZ	45152	1783100	FENDER,REAR,LH SIDE	1
7	PAOZZ	45152	1324510	SCREW,TAPPING	2
8	PAOZZ	28520	DP-312	PLUG,HOLE	4
9	PAOZZ	83014	H360-5-2	CLAMP,LOOP	12
10	PAOZZ	45152	110310A	NUT,SLFLKG,EX	4
11	PFOZZ	45152	1937190	PLATE	2
12	PAOZZ	52167	WE0630TB	SCREW,CAP,FLANGED HE	4
13	PFOZZ	45152	1783110	BRACE	4
14	PAOZZ	45152	1600460	NUT,HEX	8
15	PAOZZ	45152	1437220	NUT,SLFLKG,EX	6
16	PFOZZ	45152	1921380	TUBE	2
17	PFOZZ	45152	2068380	BRACE,FENDER	2
18	PAOZZ	19207	10892331	WASHER,FLAT	2
19	PAOZZ	45152	1321600	GUARD,SPLASH,VEHICU	2
20	PAOZZ	45152	1333510	NUT,SELF-LOCKING,EX	6

END OF FIGURE

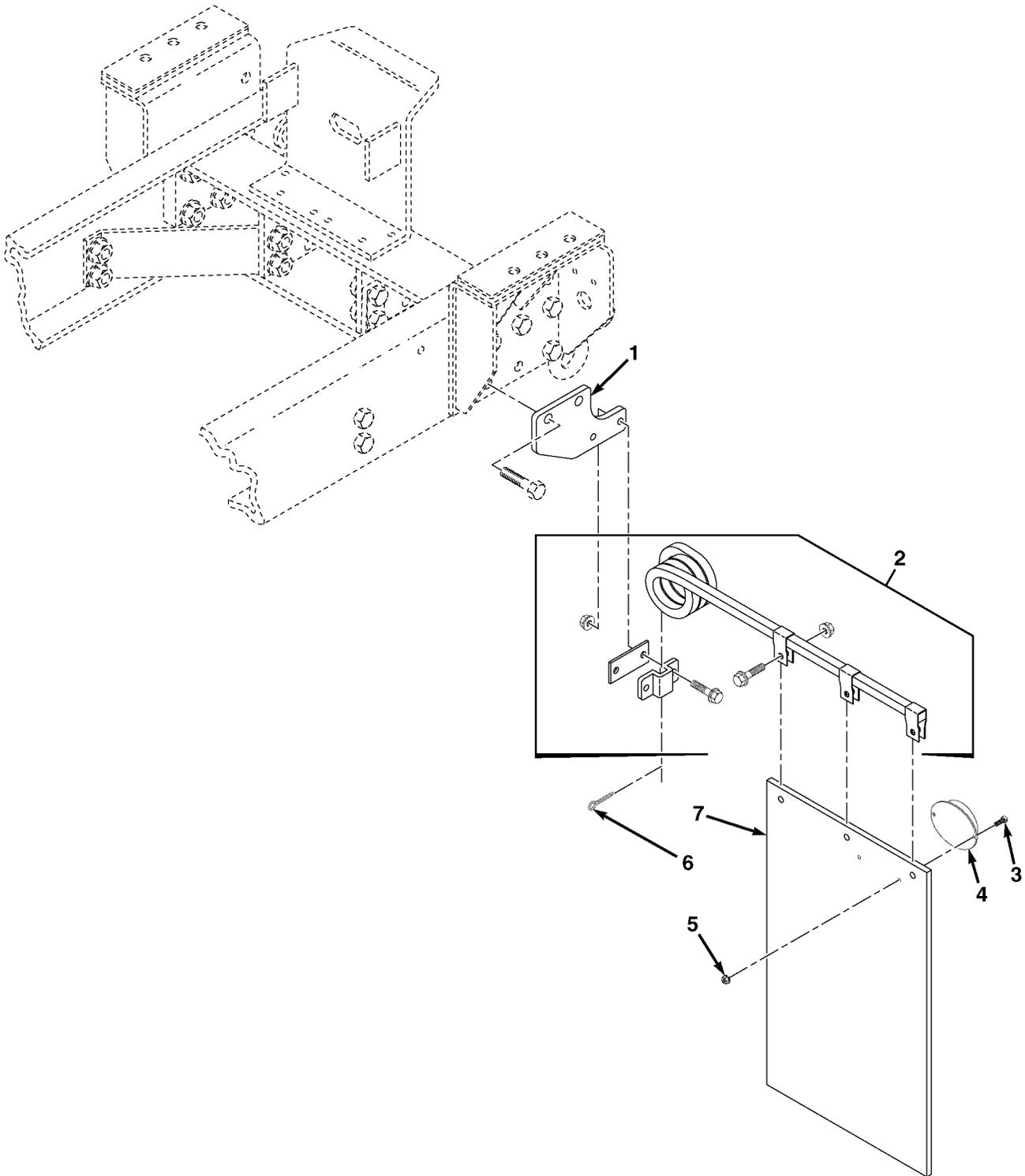

FIG. 25 REAR MUD FLAP INSTALLATION

SECTION II

TM 9-2320-304-14&P

(1) ITEM NO	(2) SMR CODE	(3) CAGEC CAGEC	(4) PART NUMBER	(5) DESCRIPTION AND USABLE ON CODES(UC)	(6) QTY
				GROUP 1802 FENDERS, RUNNING BOARDS WITH MOUNTING PARTS, ATTACHING PARTS, WINDSHIELD, GLASS, ETC. FIG. 25 REAR MUD FLAP INSTALLATION	
1	PAFZZ	45152	3263040	BRACKET,MOUNTING	2
2	PAOZZ	45152	1500280	MUD FLAP ACCESSORY BRACKET	2
3	PAOZZ	96906	MS35206-280	SCREW,MACHINE	4
4	PAOZZ	96906	MS35387-1	REFLECTOR,RED	2
5	PAOZZ	45152	1600468	NUT,SELF-LOCKING,HEX	4
6	PAOZZ	96906	MS24665-624	PIN,COTTER	2
7	PAOZZ	45152	1312410	GUARD,SPLASH,VEHICU	2

END OF FIGURE

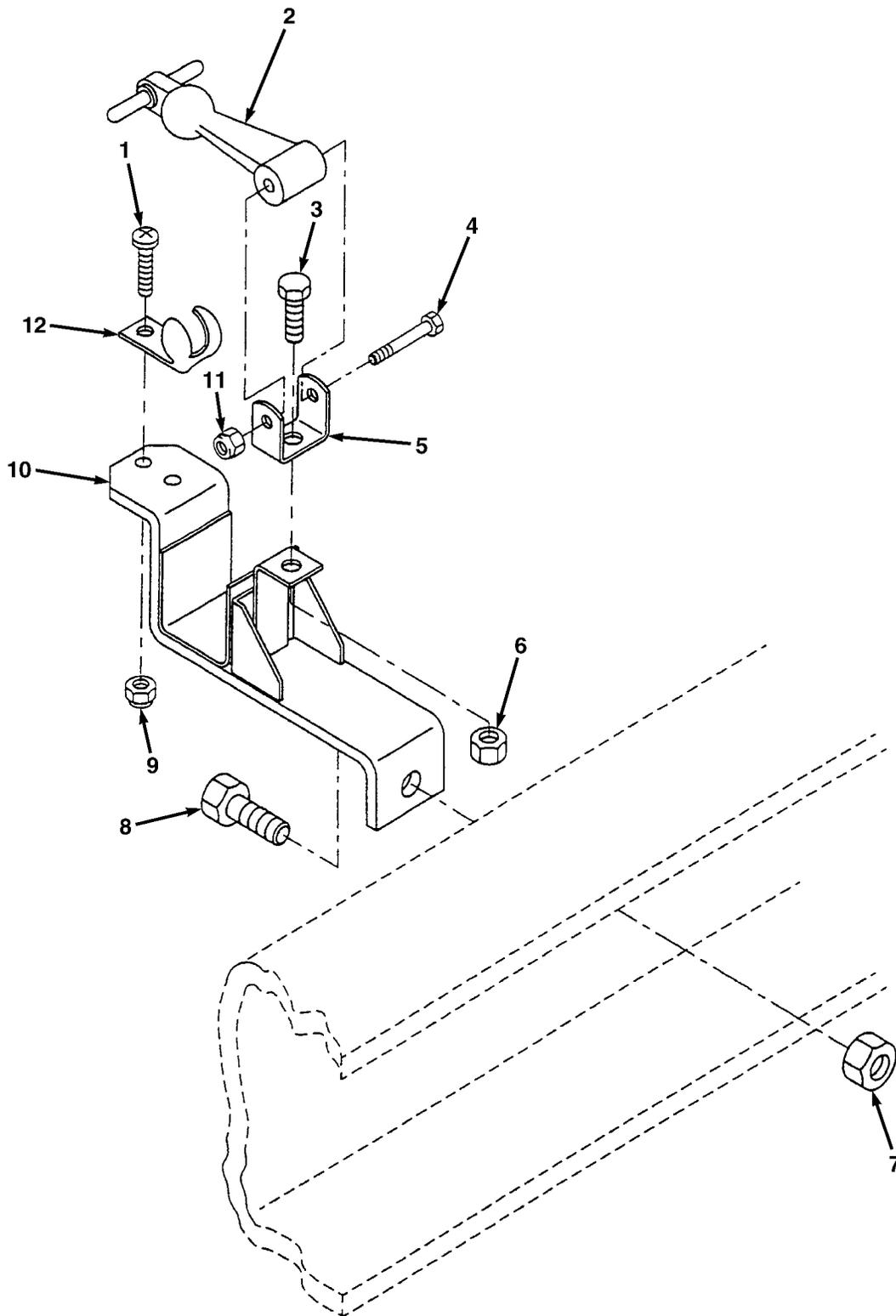

FIG. 26 LADDER SUPPORTS

SECTION II

TM 9-2320-304-14&P

(1) ITEM NO	(2) SMR CODE	(3) CAGEC CAGEC	(4) PART NUMBER	(5) DESCRIPTION AND USABLE ON CODES(UOC)	(6) QTY
GROUP 1802 FENDERS, RUNNING BOARDS WITH MOUNTING PARTS, ATTACHING PARTS, WINDSHIELD, GLASS, ETC. FIG. 26 LADDER SUPPORTS					
1	PAOZZ	45152	59031AX	SCREW,MACHINE	2
2	PAOZZ	64386	67D794	LATCH,HOOK,VEHICULAR	1
3	PFOZZ	45152	1367HX1	SCREW,CAP,HEX HD	1
4	PAOZZ	80204	B1821BH025C175N	BOLT,MACHINE	1
5	PAOZZ	64386	277-A-80-1	STRAP,RETAINING	1
6	PAOZZ	96906	MS51922-9	NUT,SLFLKG,HEX	1
7	PAOZZ	82458	T893R	NUT,SLFLKG,EW,HEX	1
8	PAOZZ	52167	WC0414PB	BOLT,MACHINE	1
9	PAOZZ	88044	AN365-1024A	NUT,SLFLKG,HEX	2
10	PFOZZ	45152	1778690W	SUPPORT	1
11	PAOZZ	96906	MS51943-31	NUT,SLFLKG,HEX	1
12	PAOZZ	74687	028-561	HOOK,SUPPORT	1

END OF FIGURE

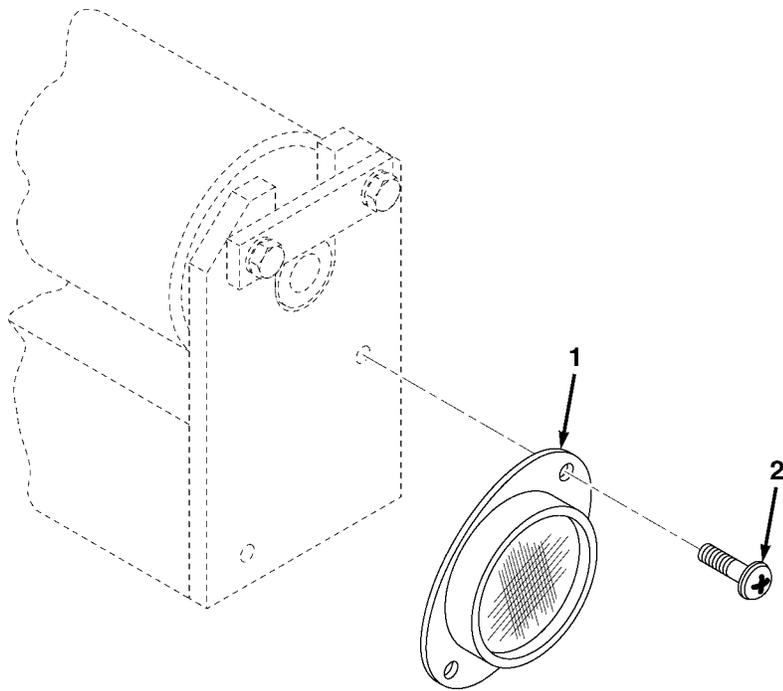

FIG. 27 REAR ROLLER ASSEMBLY REFLECTORS

SECTION II

TM 9-2320-304-14&P

(1) ITEM NO	(2) SMR CODE	(3) CAGEC	(4) PART NUMBER	(5) DESCRIPTION AND USABLE ON CODES(UOC)	(6) QTY
				GROUP 22 BODY, CHASSIS, OR HULL AND ACCESSORY ITEMS	
				GROUP 2202 ACCESSORY ITEMS	
				FIG. 27 REAR ROLLER ASSEMBLY REFLECTORS	
1	PAOZZ	96906	MS35387-2	REFLECTOR,INDICATIN	1
2	PAOZZ	96906	MS35206-280	SCREW,MACHINE	2

END OF FIGURE

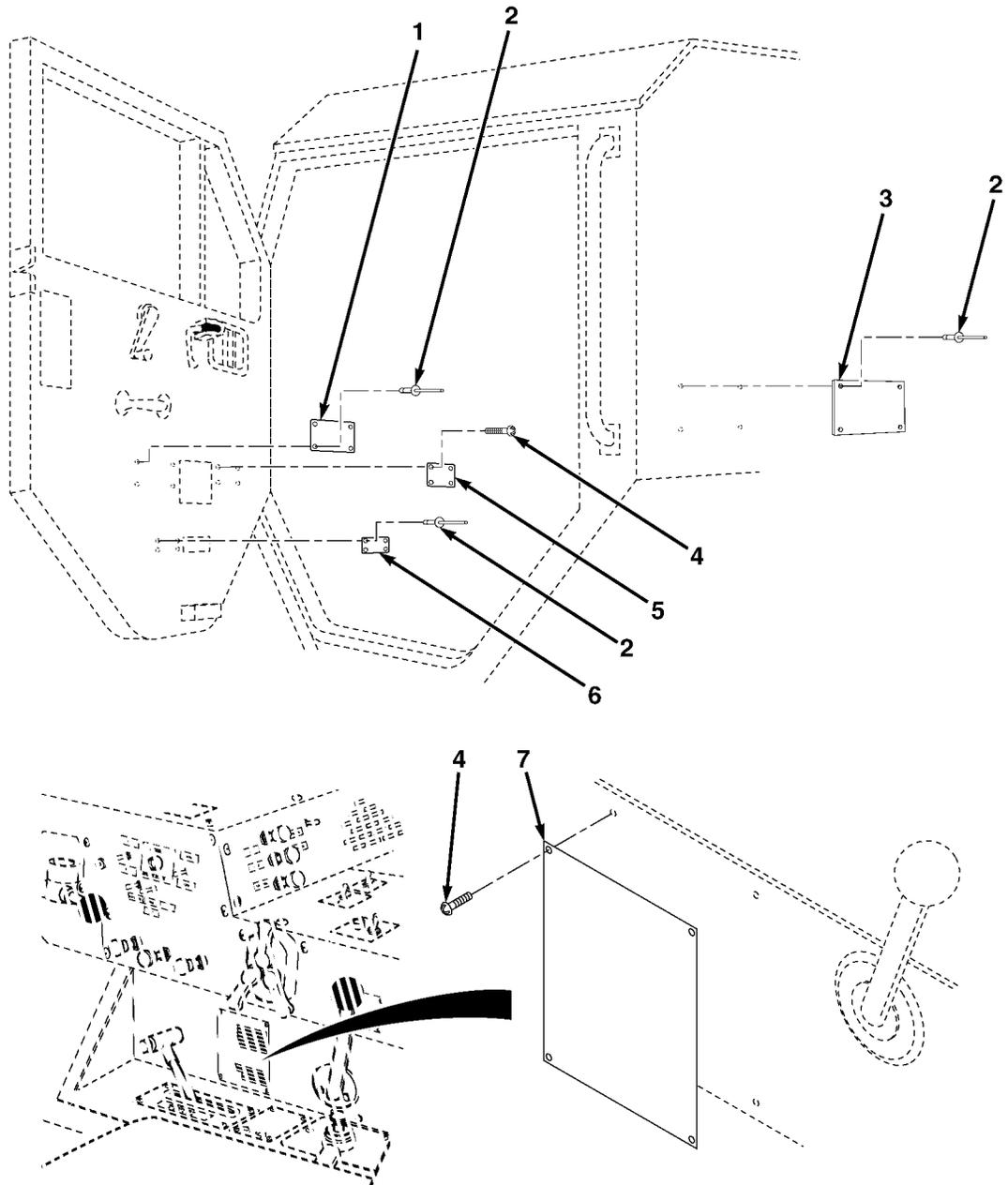

FIG. 28 LHS DATA PLATES (SHEET 1 OF 2)

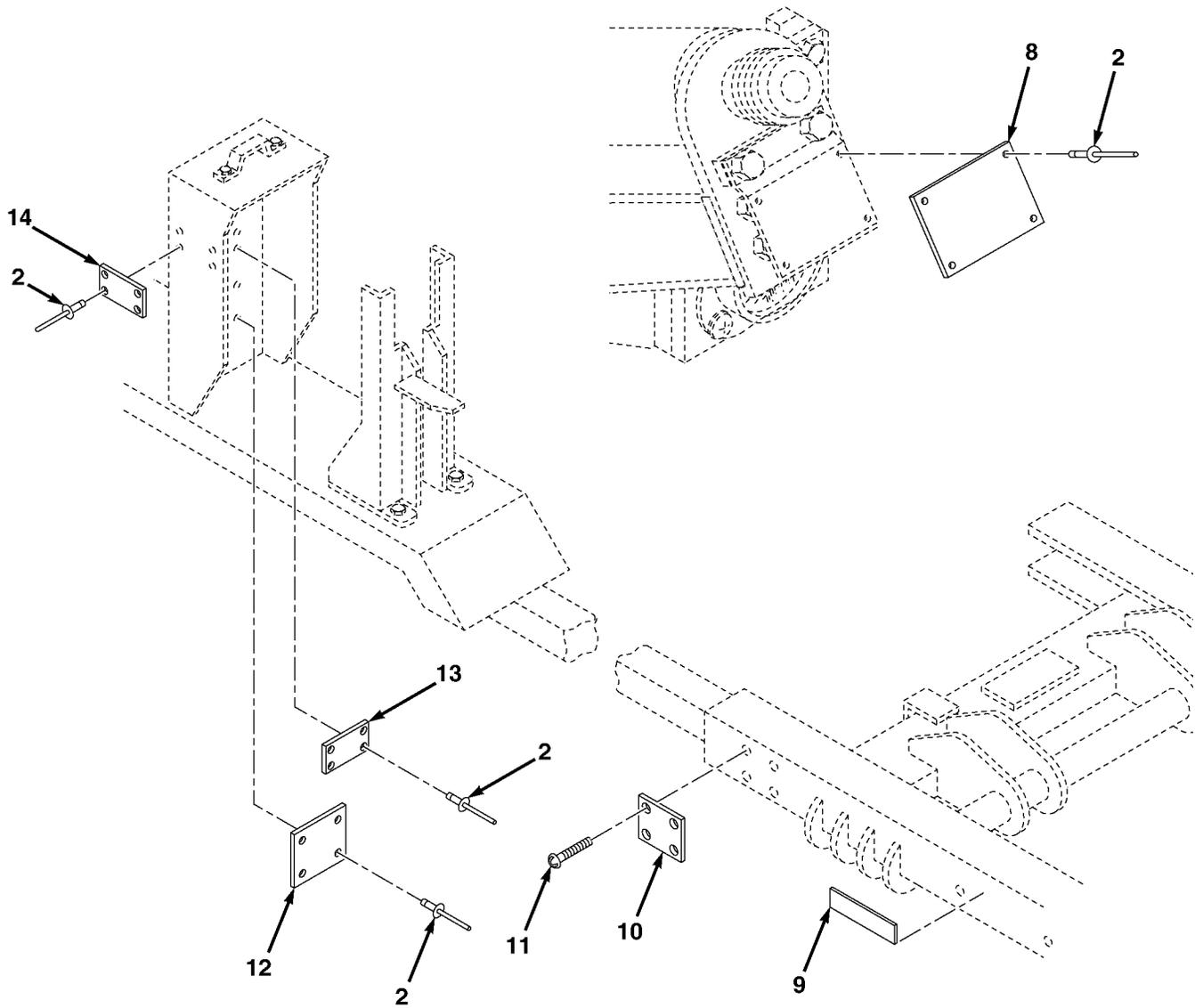

FIG. 28 LHS DATA PLATES (SHEET 2 OF 2)

SECTION II

TM 9-2320-304-14&P

(1) ITEM NO	(2) SMR CODE	(3) CAGEC CAGEC	(4) PART NUMBER	(5) DESCRIPTION AND USABLE ON CODES(UOC)	(6) QTY
				GROUP 22 BODY, CHASSIS, OR HULL & ACCESSORY ITEMS	
				GROUP 2210 DATA PLATES AND INSTRUCTION HOLDERS	
				FIG. 28 LHS DATA PLATES	
1	PFOZZ	45152	3126523	PLATE, MGF'S CERT	1
2	PFOZZ	3Z048	BTT43	RIVET, BLIND	24
3	PFOZZ	45152	3285672	PLATE, DATA SHIPPING	1
4	PFOZZ	45152	1381HX1	SCREW, SHEET METAL	8
5	PFOZZ	45152	3064067	PLATE, IDENTIFICATION	1
6	PFOZZ	45152	1320590	PLATE, INSTRUCTION	1
7	PFOZZ	45152	3064068	PLATE, IDENTIFICATION	1
8	PFOZZ	45152	1783190	PLATE, DATA WARNING	2
9	PFOZZ	45152	1987130	LABEL, MULTILIFT	2
10	PFOZZ	45152	3285659	PLATE, IDENTIFICATION	1
11	PFOZZ	96906	MS21318-20	SCREW, DRIVE	4
12	PFOZZ	45152	1948290	PLATE, DATA LHS OVERRIDE	1
13	PFOZZ	45152	1920730	PLATE, DATA MULTILIFT	1
14	PAOZZ	45152	1785220	DATE PLATE, HYD SLAV	1

END OF FIGURE

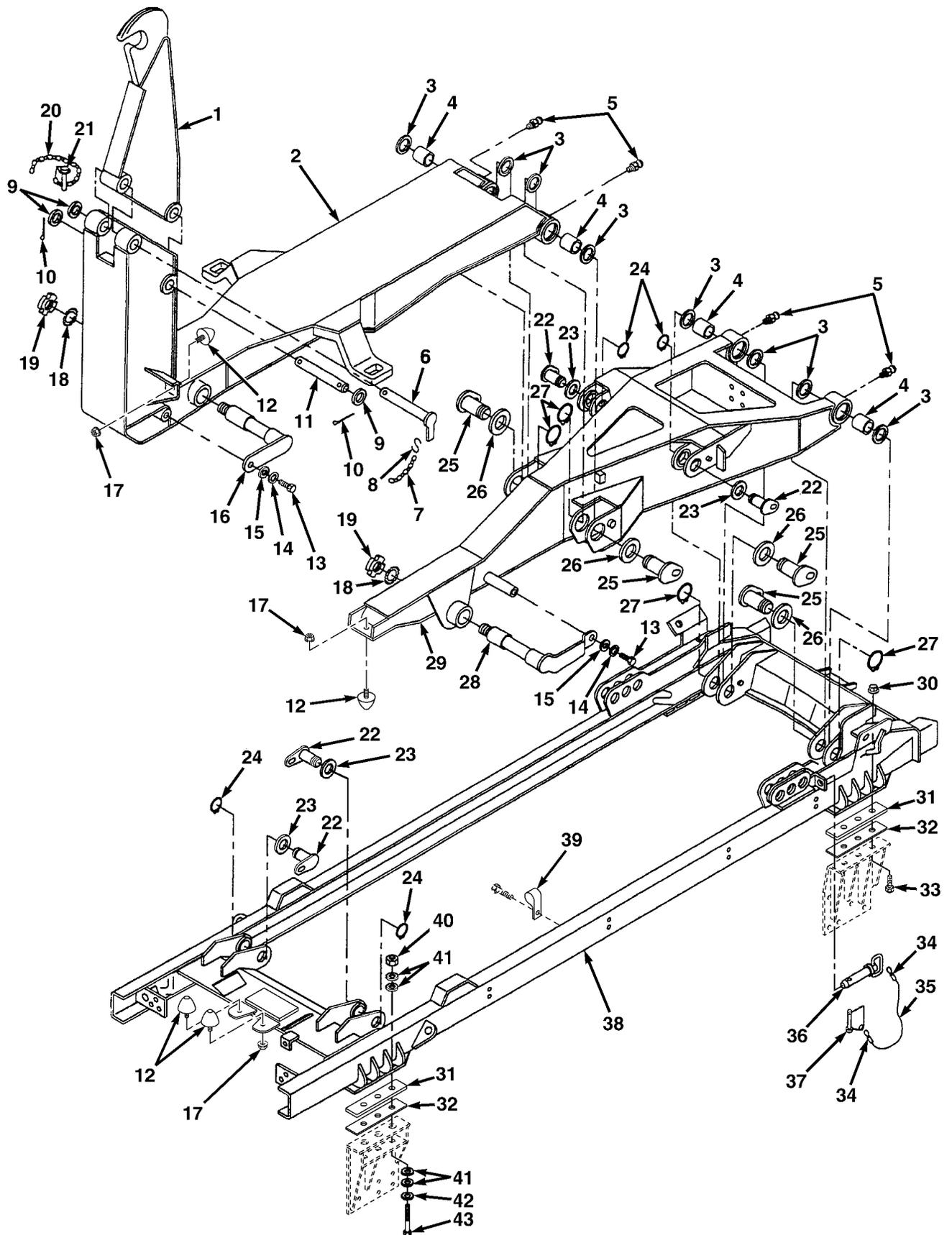

FIG. 29 LOAD HANDLING SYSTEM (SHEET 1 OF 2)

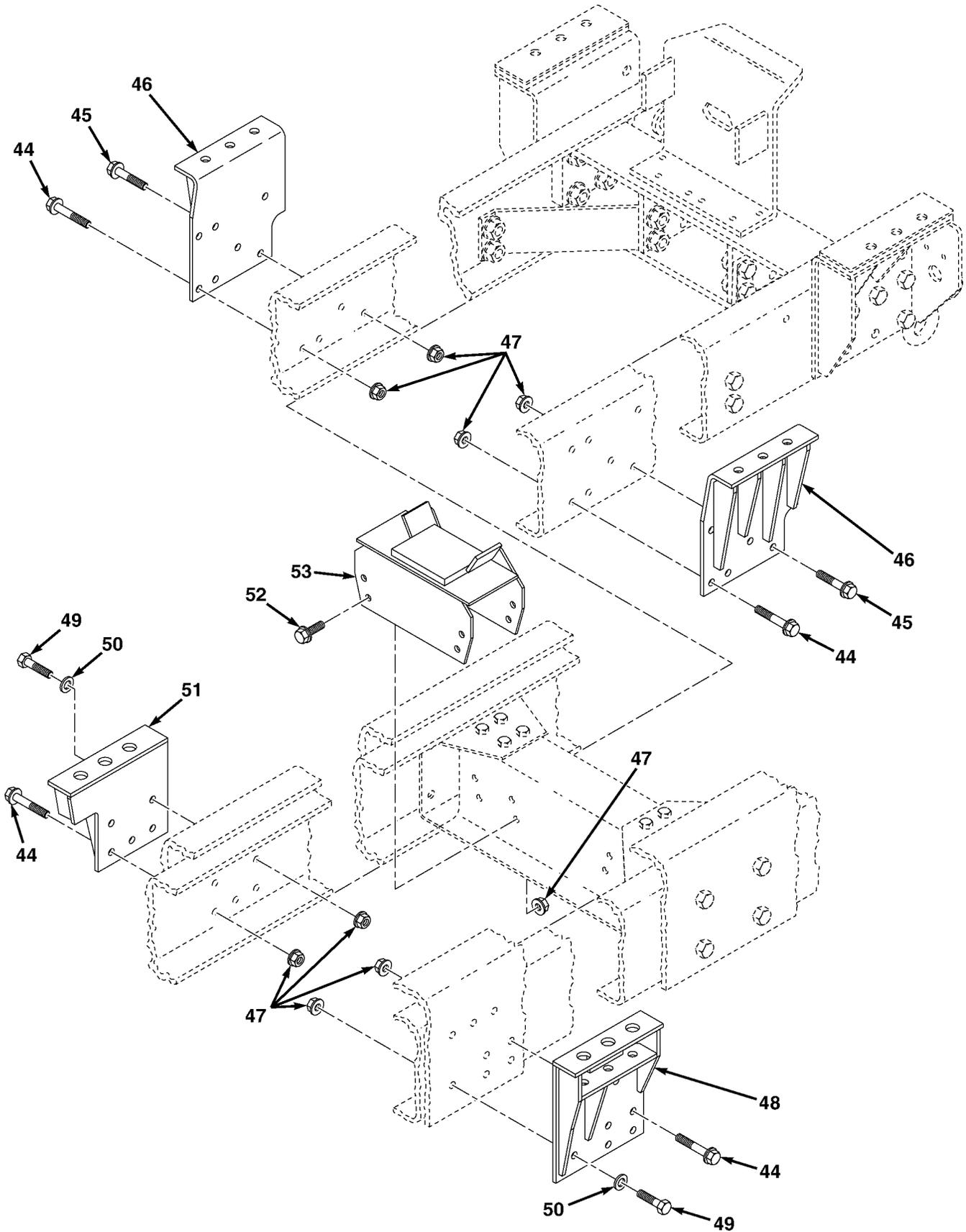

FIG. 29 LOAD HANDLING SYSTEM (SHEET 2 OF 2)

SECTION II

TM 9-2320-304-14&P

(1) ITEM NO	(2) SMR CODE	(3) CAGEC CAGEC	(4) PART NUMBER	(5) DESCRIPTION AND USABLE ON CODES(UOC)	(6) QTY
GROUP 24 HYDRAULIC AND FLUID SYSTEMS GROUP 2400 MAJOR ASSEMBLAGE (LOAD HANDLING SYSTEM) FIG. 29 LOAD HANDLING SYSTEM					
1	PBFZZ	45152	1861950	HOOKARM	1
2	XDFZZ	45152	1861940	ARM,HOOK	1
3	PAFZZ	01212	80X100X10	SEAL,OIL	8
4	PAFZZ	2K272	GLY.PG808560A	BUSHING	4
5	PAOZZ	45152	615FX	FITTING,LUBE	4
6	PAFZZ	45152	1862720W	PIN,HOOK ARM,RETAIN	1
7	MFFZZ	45152	1394510-012	CHAIN,WELDED MAKE FROM CHAIN P/N 031-0424 (80535), 12 IN LG	1
8	PFFZZ	35111	811	HOOK	1
9	PAFZZ	72447	330734	WASHER,FLAT	3
10	PAFZZ	96906	MS24665-15	PIN,COTTER	2
11	PFFZZ	45152	1862770	PIN,PIVOT HOOK ARM	1
12	PFFZZ	45152	1897980	BUMPER,RUBBER	5
13	PFFZZ	45152	2013HX1	SCREW,CAP,HEX HD	2
14	PAFZZ	45152	351AX	WASHER,LOCK	2
15	PFFZZ	19207	10892331	WASHER,FLAT	2
16	PFFZZ	45152	1863010W	SHAFT ASSY,CYLINDER	1
17	PAFZZ	45152	1598030	NUT,HEX,FLANGE	5
18	PAFZZ	2K272	W12	WASHER,LOCK	2
19	PAFZZ	96906	MS19068-121	LOCKNUT	2
20	MFFZZ	45152	1394510-018	CHAIN,WELDED MAKE FROM CHAIN P/N 031-0424 (80535), 18 IN LG	1
21	PAFZZ	96652	28-04	PIN,SNAPPER	1
22	PAFZZ	45152	1860250W	PIN,PIVOT MAIN CYL	4
23	PAFZZ	45152	1862830	SHIM	4
24	PAFZZ	96906	MS16624-250	RING,RETAINING	4
25	PAFZZ	45152	1860310W	PIN,PIVOT MID FRAME	4
26	PFFZZ	45152	1862820	SHIM	4
27	PAFZZ	79136	5100-315	RING,RETAINING	4
28	PAFZZ	45152	1862690W	SHAFT ASSY,CYLINDER	1
29	PAFZZ	45152	3051121	FRAME,MIDDLE MACH	1
30	PAFZZ	45152	110312A	NUT,SLFLKG,EW,HEX	6
31	PAFZZ	45152	3053913	SPACER,PLATE	4
32	PAFZZ	45152	3055129	SPACER,PLATE	4
33	PAFZZ	45152	111320A	SCREW,CAP,HEX HD	6
34	PFOZZ	96906	MS51844-43	SWAGE SLVE,WIRE ROPE	2
35	MFOZZ	45152	1533100-022	ROPE,WIRE MAKE FROM ROPE P/N 1533100 (45152), 22 IN LG	2
36	PAFZZ	45152	1956170	PIN,HITCH	2
37	PAFZZ	45152	1965220	PIN,QUICK RELEASE	2
38	PBFZZ	45152	3055132	FRAME,COMPRESSION	1
39	PAOZZ	84971	TA720-S8	CLIP,CUSHIONED	4
40	PAFZZ	10001	2533408-26	NUT,PLAIN,HEX	6
41	PAFZZ	81349	M12133/1-12P	WASHER,SPRING	48
42	PAFZZ	45152	2083HX	WASHER,FLAT	6
43	PAFZZ	45152	EE103647	SCREW,CAP,HEX HD	6

SECTION II			TM 9-2320-304-14&P C01		
(1)	(2)	(3)	(4)	(5)	(6)
ITEM	SMR		PART		
NO	CODE	CAGEC	NUMBER	DESCRIPTION AND USABLE ON CODES(UOC)	QTY
44	PAFZZ	45152	111452A	BOLT,MACHINE	8
45	PAFZZ	45152	120622A	BOLT,MACHINE	6
46	PAFZZ	45152	3053775	BRACKET,MULTIPLE AN	1
46	PAFZZ	45152	3053774	BRACKET,MULTIPLE AN	1
47	PAFZZ	45152	110311A	NUT,SELF-LOCKING,EW	35
48	PAFZZ	45152	3053776	BRACKET,MULTIPLE AN	1
49	PAFZZ	52167	WE0820TB	SCREW,FLANGE,HEX	4
50	PAFZZ	45152	8865GX	WASHER,FLAT	6
51	PAFZZ	45152	3053777	BRACKET,MULTIPLE AN	1
52	PAFZZ	52167	WE0816TB	BOLT,MACHINE	8
53	XDFZZ	45152	3056872	SUPPORT,MIDDLE FRAME NOSE	1

END OF FIGURE

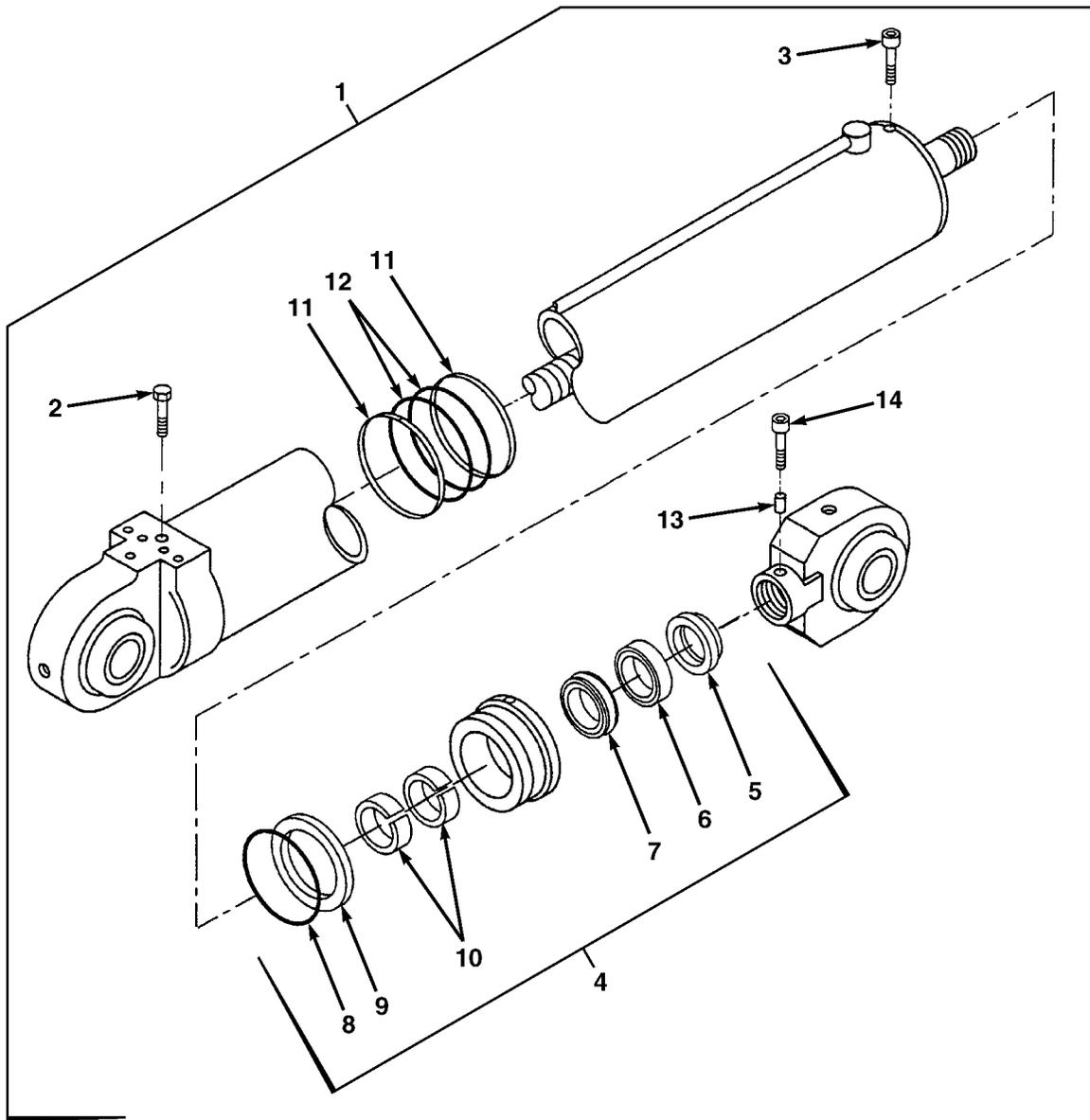

FIG. 30 LHS HOOK ARM CYLINDER

SECTION II

TM 9-2320-304-14&P

(1) ITEM NO	(2) SMR CODE	(3) CAGEC CAGEC	(4) PART NUMBER	(5) DESCRIPTION AND USABLE ON CODES(UOC)	(6) QTY
GROUP 2405 MAST COLUMN					
FIG. 30 LHS HOOK ARM CYLINDER					
1	PFFFF	63899	150234B	CYLINDER ASSEMBLY,HOOK	1
2	PFFZZ	63899	711009A	.SCREW,CAP,HEX	1
3	PFFZZ	63899	711053A	.SCREW,CAP,HEX	1
4	PFFZZ	63899	500419B	.BEARING ASSY,ROD	1
5	KFFZZ	63899	702001A	..WIPER,ROD PART OF KIT P/N 430457B ..	1
6	KFFZZ	63899	701121A	..SEAL,ROD PART OF KIT P/N 430457B ...	1
7	KFFZZ	63899	706069A	..STEP SEAL,K-R ASSY PART OF KIT P/N 430457B	1
8	KFFZZ	63899	703425A	..PACKING,PREFORMED PART OF KIT P/N 430457B	1
9	KFFZZ	63899	704425A	..RING,BACKUP PART OF KIT P/N 430457B	1
10	KFFZZ	63899	721175A	..RING,WEAR PART OF KIT P/N 430457B ..	2
11	KFFZZ	63899	721176A	.RING,WEAR PART OF KIT P/N 430457B ...	2
12	KFFZZ	63899	700079A	.SEAL ASSY,PISTON PART OF KIT P/N 430457B	1
13	PFFZZ	63899	715001A	.PLUG,NYLON	1
14	PFFZZ	63899	711083A	.SCREW,CAP,HEX	1

END OF FIGURE

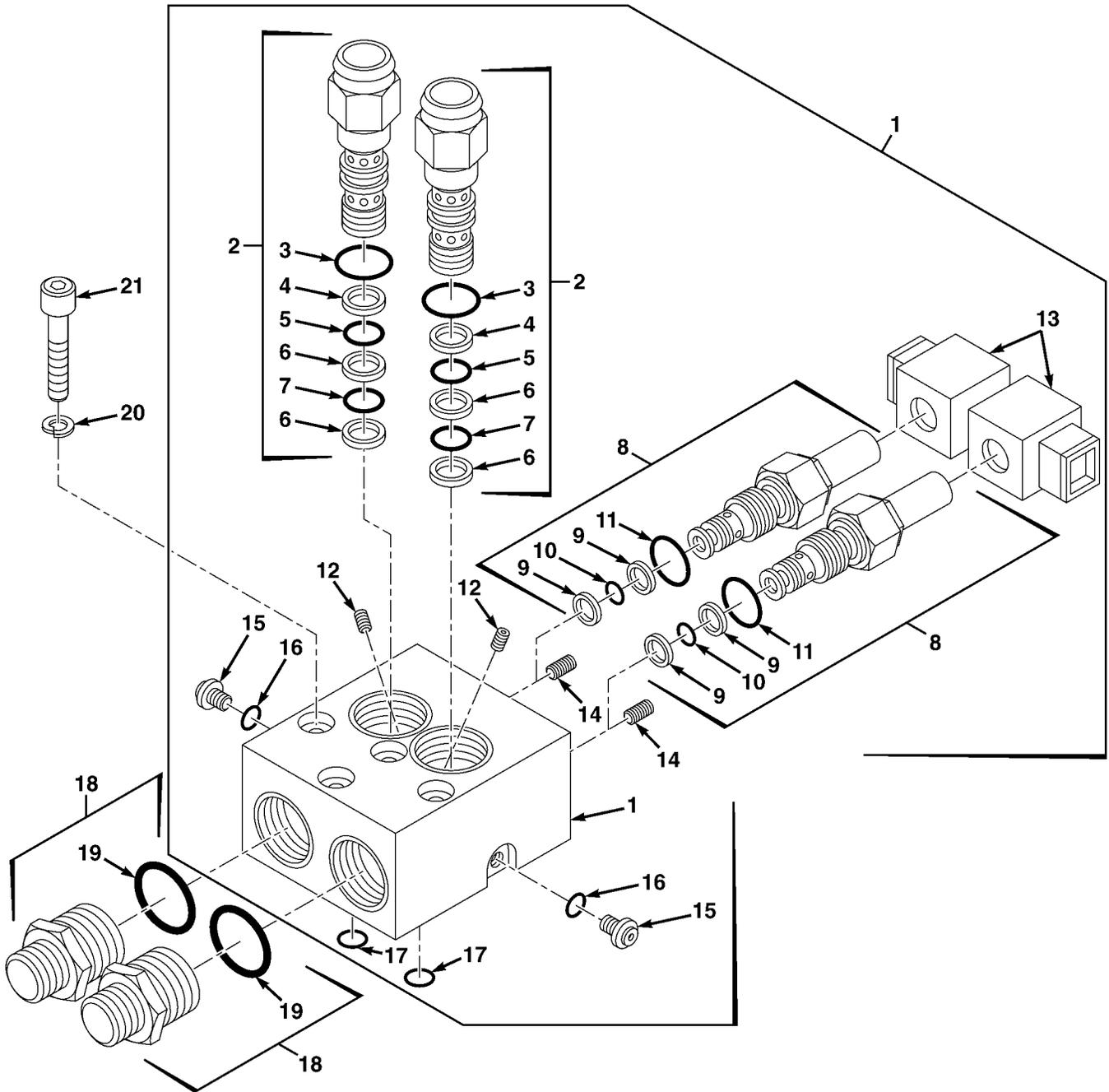

FIG. 31 LHS HOOK ARM MANIFOLD

SECTION II

TM 9-2320-304-14&P

(1) ITEM NO	(2) SMR CODE	(3) CAGEC CAGEC	(4) PART NUMBER	(5) DESCRIPTION AND USABLE ON CODES(UC) QTY	(6) QTY
GROUP 2406 STRAINERS, FILTERS, LINES, AND FITTINGS, ETC. FIG. 31 LHS HOOK ARM MANIFOLD					
1	PAFZZ	45152	1891390	MANIFOLD,HOOK ARM	1
2	PAFFF	0FHH8	E2A50Y4350NMK2	.VALVE,LOAD CONTROL	2
3	KFFZZ	0FHH8	8024N912	..PACKING,PREFORMED PART OF KIT P/N .. SK3-0039N-1	1
4	KFFZZ	0FHH8	8025N9016	..RING,BACKUP PART OF KIT P/N SK3-0039N-1	1
5	KFFZZ	0FHH8	8023N7015	..PACKING,PREFORMED PART OF KIT P/N SK3-0039N-1	1
6	KFFZZ	0FHH8	8025N9015	..RING,BACKUP PART OF KIT P/N SK3-0039N-1	2
7	KFFZZ	0FHH8	8022N7017	..PACKING,PREFORMED PART OF KIT P/N SK3-0017N-1	1
8	PAFZF	0FHH8	GS028000N	.VALVE,SOLENOID	2
9	KFFZZ	0FHH8	900565-012	..RING,BACKUP PART OF KIT P/N SK3-0088N-1	2
10	KFFZZ	0FHH8	8023N7009	..PACKING,PREFORMED PART OF KIT P/N SK3-0088N-1	1
11	KFFZZ	0FHH8	8024N908	..PACKING,PREFORMED PART OF KIT P/N SK3-0088N-1	1
12	PFFZZ	0FHH8	9P000202	.PLUG,ORIFICE	2
13	PAFZZ	0FHH8	CCS024D	.COIL,24V	2
14	PFFZZ	0FHH8	8H38529/53	.PLUG,ORIFICE	2
15	PFFZZ	0FHH8	801001M	.PLUG,HEX,HOLLOW	2
16	KFFZZ	0FHH8	8024N902	..PACKING,PREFORMED PART OF KIT P/N 9S000104	2
17	PAFZZ	0FHH8	8023N7013	..PACKING,PREFORMED PART OF KIT P/N 9S000104	2
18	PAFFF	01276	202702-8-8S	ADAPTER,STRAIGHT	4
19	PAFZZ	01276	22617-8	..PACKING,PREFORMED	1
20	PAFZZ	45152	1937550	WASHER,LOCK	8
21	PAFZZ	45152	3064801	SCREW,CAP,SOCKET HD	8

END OF FIGURE

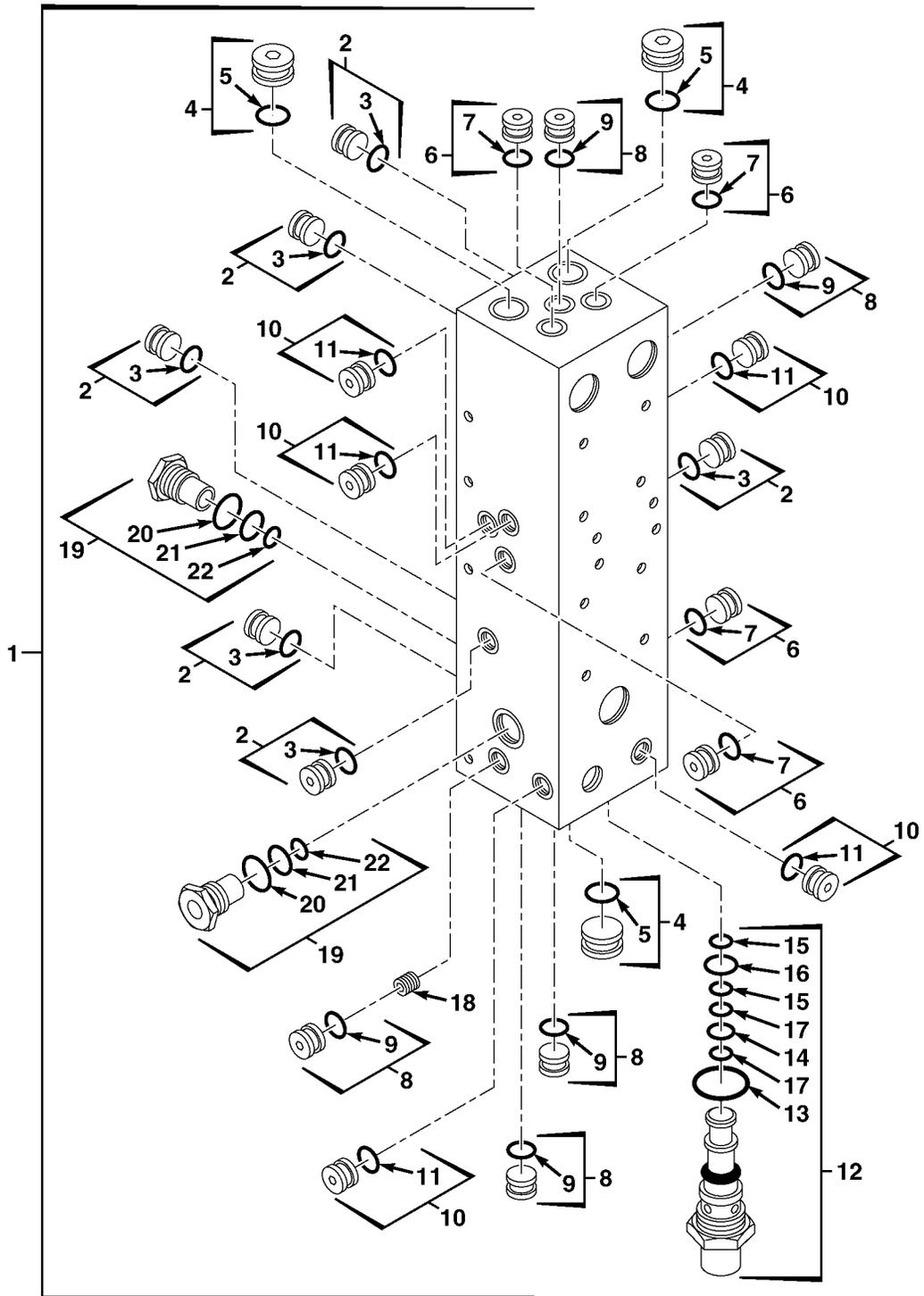
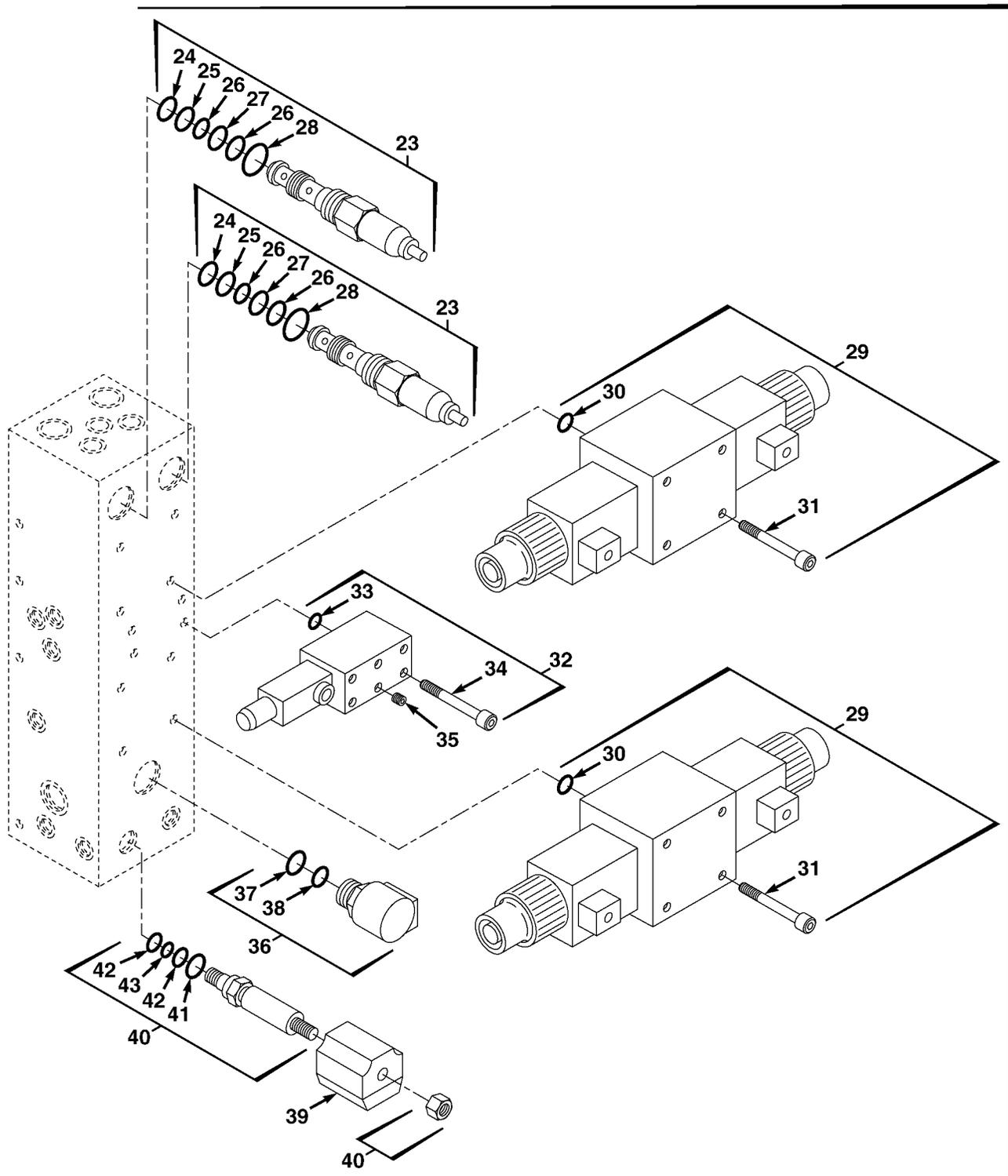

FIG. 32 LHS MAIN MANIFOLD, RELIEF VALVES, AND LOAD CONTROL VALVES
(SHEET 1 OF 2)



1

FIG. 32 LHS MAIN MANIFOLD, RELIEF VALVES, AND LOAD CONTROL VALVES
(SHEET 2 OF 2)

SECTION II

TM 9-2320-304-14&P

(1) ITEM NO	(2) SMR CODE	(3) CAGEC CAGEC	(4) PART NUMBER	(5) DESCRIPTION AND USABLE ON CODES(UOC)	(6) QTY
GROUP 2406 STRAINERS, FILTERS, LINES, AND FITTINGS, ETC. FIG. 32 LHS MAIN MANIFOLD, RELIEF VALVES AND LOAD CONTROL VALVES					
1	PFFHH	0FHH8	8F 3931	MANIFOLD, HYDRAULIC	1
2	PFFZZ	0FHH8	801004M	. PLUG, HEX, HOLLOW	6
3	KFFZZ	0FHH8	8024N905	.. PACKING, PREFORMED PART OF KIT P/N 9S000106	1
4	PFFZZ	0FHH8	801006M	. PLUG, HEX, HOLLOW	3
5	KFFZZ	0FHH8	8024N908	.. PACKING, PREFORMED PART OF KIT P/N 9S000106	1
6	PFFZZ	0FHH8	801005M	. PLUG, HEX, HOLLOW	4
7	KFFZZ	0FHH8	8024N906	.. PACKING, PREFORMED PART OF KIT P/N 9S000106	1
8	PFFZZ	0FHH8	801003M	. PLUG, HEX, HOLLOW	5
9	KFFZZ	0FHH8	8024N904	.. PACKING, PREFORMED PART OF KIT P/N 9S000106	1
10	PFFZZ	0FHH8	801001M	. PLUG, HEX, HOLLOW	5
11	KFFZZ	0FHH8	8024N902	.. PACKING, PREFORMED PART OF KIT P/N 9S000106	1
12	PFFZZ	0FHH8	A4B125T053525N	. VALVE, RELIEF	1
13	KFFZZ	0FHH8	8024N914	.. PACKING, PREFORMED PART OF KIT P/N SK3-0024N-1	1
14	KFFZZ	0FHH8	8023N7017	.. PACKING, PREFORMED PART OF KIT P/N SK3-0024N-1	1
15	KFFZZ	0FHH8	8025N9018	.. RING, BACKUP PART OF KIT P/N SK3-0024N-1	2
16	KFFZZ	0FHH8	8023N7018	.. PACKING, PREFORMED PART OF KIT P/N SK3-0024N-1	1
17	KFFZZ	0FHH8	8025N9017	.. RING, BACKUP PART OF KIT P/N SK3-0024N-1	2
18	PFFZZ	0FHH8	8H38529/53	. PLUG, ORIFICE	1
19	PAFZZ	0FHH8	D2A60-5.0N	. VALVE, CHECK	2
20	KFFZZ	0FHH8	8024N910	.. PACKING, PREFORMED PART OF KIT P/N SK3-0002N-1	1
21	KFFZZ	0FHH8	8025N9013	.. RING, BACKUP PART OF KIT P/N SK3-0002N-1	1
22	KFFZZ	0FHH8	8022N7014	.. PACKING, PREFORMED PART OF KIT P/N SK3-0002N-1	1
23	PAFZZ	0FHH8	E2E125Z4350NMK2	. VALVE, LOAD CONTROL	2
24	KFFZZ	0FHH8	8022N7019	.. PACKING, PREFORMED PART OF KIT P/N SK3-0035N-1	1
25	KFFZZ	0FHH8	8025N9019	.. RING, BACKUP PART OF KIT P/N SK3-0035N-1	1
26	KFFZZ	0FHH8	8025N9020	.. RING, BACKUP PART OF KIT P/N SK3-0035N-1	2
27	KFFZZ	0FHH8	8022N7020	.. PACKING, PREFORMED PART OF KIT P/N SK3-0035N-1	1
28	KFFZZ	0FHH8	8024N916	.. PACKING, PREFORMED PART OF KIT P/N SK3-0035N-1	1
29	PFFZZ	0FHH8	9DD000240	. VALVE, DC	2

SECTION II			TM 9-2320-304-14&P C01		
(1)	(2)	(3)	(4)	(5)	(6)
ITEM	SMR		PART		
NO	CODE	CAGEC	NUMBER	DESCRIPTION AND USABLE ON CODES(UOC)	QTY
30	KFFZZ	0FHH8	8023N7011	..PACKING,PREFORMED PART OF KIT P/N 9S000106	5
31	PFFZZ	0FHH8	804902B1W	.SCREW,CAP,SCH	8
32	PFFZZ	0FHH8	9DD000239	.VALVE,DC	1
33	KFFZZ	0FHH8	8023N7009	..PACKING,PREFORMED PART OF KIT P/N 9S000106	4
34	PFFZZ	0FHH8	9DD000241	.SCREW,CAP,SCH	4
35	PFFZZ	0FHH8	8H38529/53	.PLUG,ORIFICE	3
36	PFFZZ	0FHH8	9DD000255	.SWITCH	1
37	KFFZZ	0FHH8	8024N908	..PACKING,PREFORMED PART OF KIT P/N 9S000106	1
38	KFFZZ	0FHH8	8023N7011	..PACKING,PREFORMED PART OF KIT P/N 9S000106	1
39	PFFZZ	0FHH8	CCS024D	.COIL,24V	1
40	PFFZZ	0FHH8	GS028510N	.VALVE,SOLENOID	1
41	KFFZZ	0FHH8	8024N908	..PACKING,PREFORMED PART OF KIT P/N SK3-0088N-1	1
42	KFFZZ	0FHH8	900565-012	..RING,BACKUP PART OF KIT P/N SK3-0088N-1	2
43	KFFZZ	0FHH8	8023N7009	..PACKING,PREFORMED PART OF KIT P/N SK3-0088N-1	1

END OF FIGURE

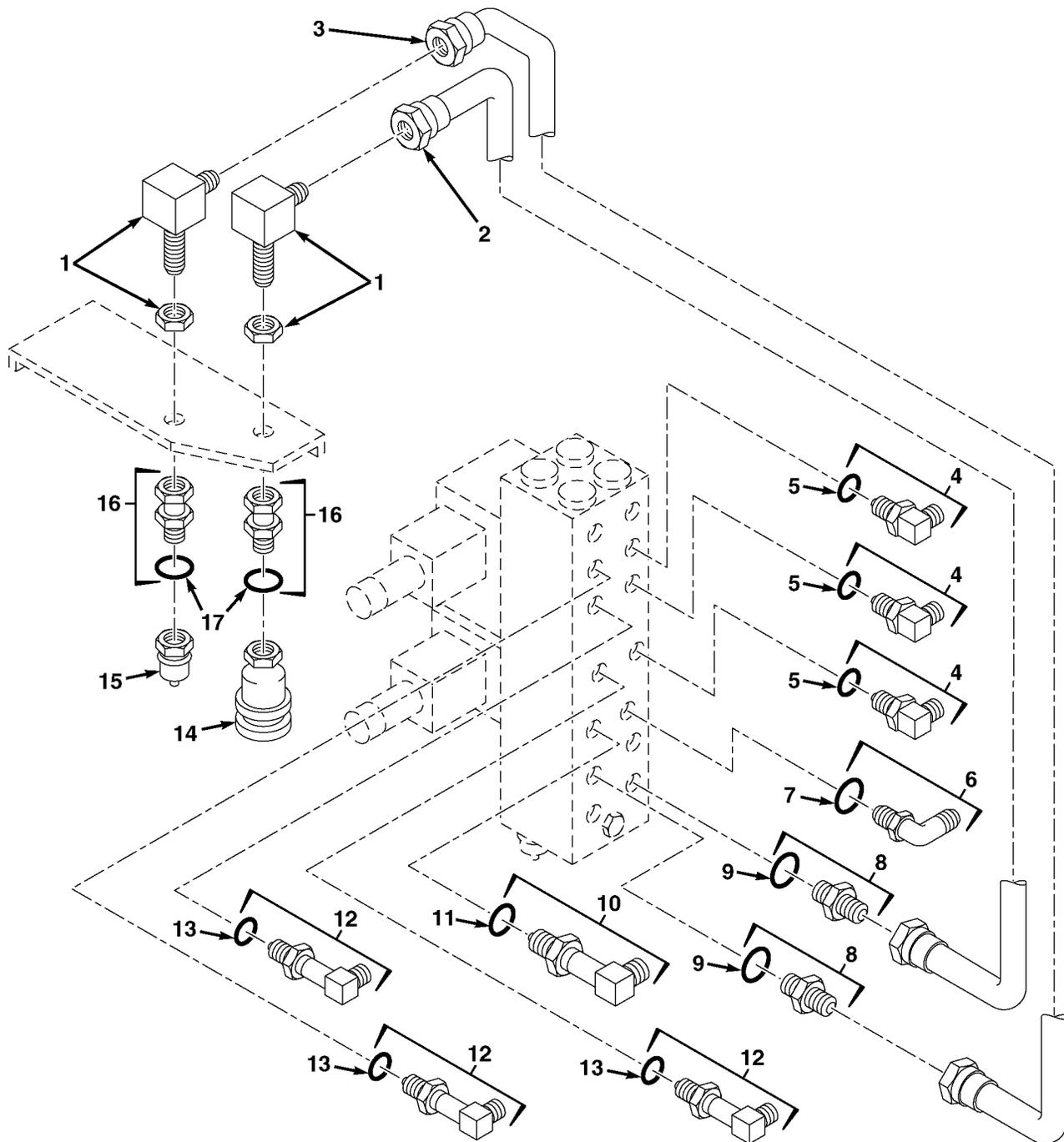

FIG. 33 LHS MAIN MANIFOLD FITTINGS AND ADAPTERS

SECTION II

TM 9-2320-304-14&P

(1) ITEM NO	(2) SMR CODE	(3) CAGEC CAGEC	(4) PART NUMBER	(5) DESCRIPTION AND USABLE ON CODES(UOC)	(6) QTY
GROUP 2406 STRAINERS, FILTERS, LINES, AND FITTINGS, ETC.					
FIG. 33 LHS MAIN MANIFOLD FITTINGS AND ADAPTERS					
1	PFFZZ	00624	2043-16-16S	ELBOW,BULKHEAD	2
2	PFFZZ	45152	1923580	TUBE ASSY	1
3	PFFZZ	45152	1923570	TUBE ASSY	1
4	PFFZZ	79470	5515X8	FITTING,ADAPTER	3
5	PAFZZ	01276	22617-8	.PACKING,PREFORMED	1
6	PFFZZ	96906	MS51527A12	ELBOW,TUBE TO BOSS	1
7	PAFZZ	01276	22617-12	.PACKING,PREFORMED	1
8	PFFZZ	96906	MS51525A12-16	ADAPTER,STRAIGHT,TU	2
9	PAFZZ	01276	22617-12	.PACKING,PREFORMED	1
10	PFFZZ	01276	206209-12-12S	ELBOW	1
11	PAFZZ	01276	22617-12	.PACKING,PREFORMED	1
12	PFFZZ	01276	206209-8-8S	ELBOW,TUBE TO BOSS	3
13	PAFZZ	01276	22617-8	.PACKING,PREFORMED	1
14	PFFZZ	01276	FD45-1169-16-16	COUPLING HALF,QUICK	1
15	PFFZZ	01276	FD45-1168-16-16	COUPLING HALF,QUICK	1
16	PFFZZ	01276	2266-16-16S	ADAPTER,STRAIGHT,TU	2
17	PAFZZ	01276	22617-16	.PACKING,PREFORMED	1

END OF FIGURE

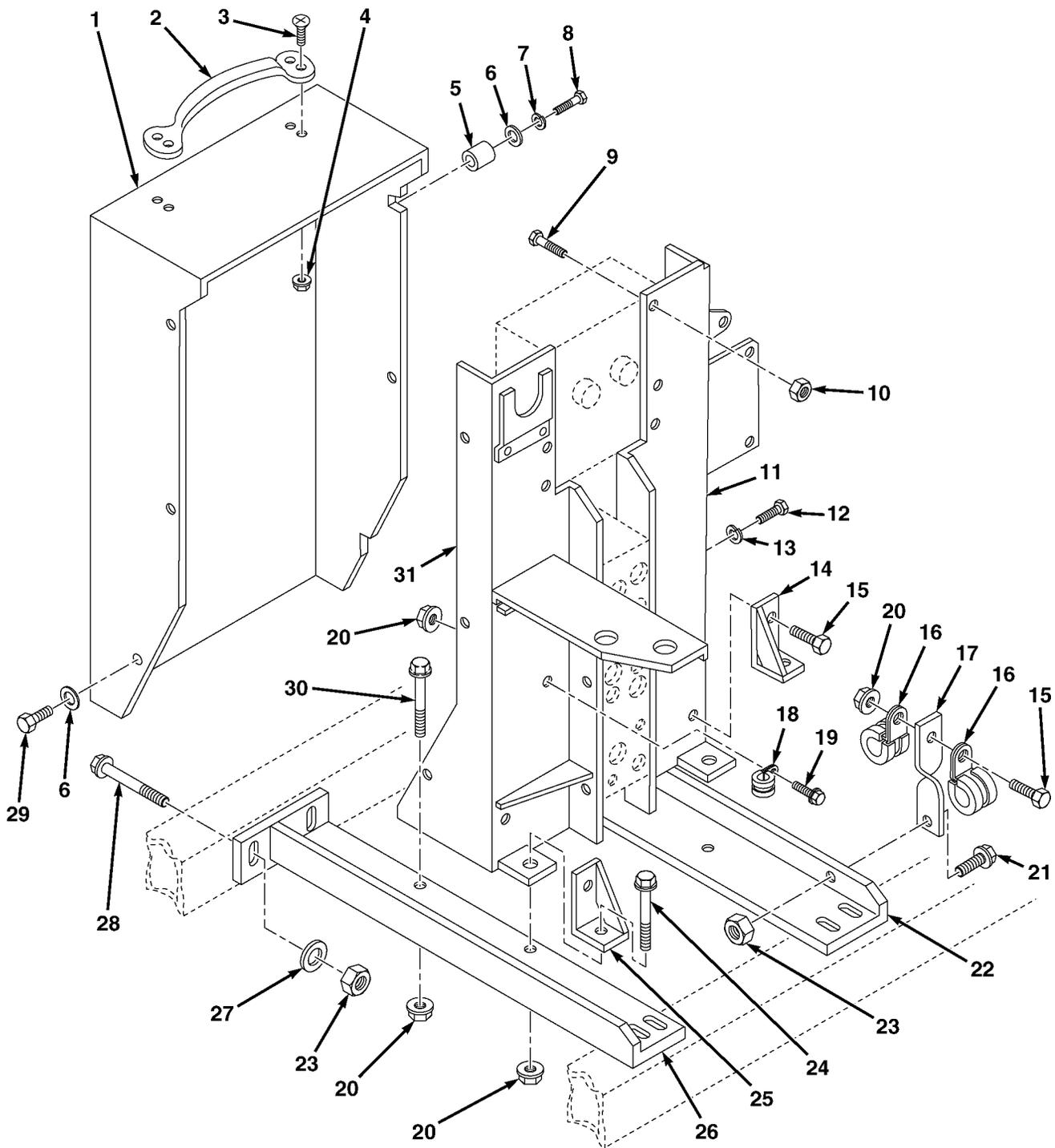

FIG. 34 LHS MAIN MANIFOLD & JUNCTION BOX MOUNTING

SECTION II

TM 9-2320-304-14&P

(1) ITEM NO	(2) SMR CODE	(3) CAGEC CAGEC	(4) PART NUMBER	(5) DESCRIPTION AND USABLE ON CODES(UOC)	(6) QTY
GROUP 2406 STRAINER, FILTERS, LINES AND FITTINGS, ETC FIG. 34 LHS MAIN MANIFOLD & JUNCTION BOX MOUNTING					
1	PFOZZ	45152	1862640	COVER,MAIN JNCTN BX	1
2	PFOZZ	57733	752023	HANDLE GRAB	1
3	PFOZZ	96906	MS35190-289	SCREW,MACHINE	4
4	PAOZZ	45152	1600460	NUT HEX	4
5	PFFZZ	45152	2063940	SPACER,SLEEVE	2
6	PAFZZ	88044	AN970-5	WASHER,FLAT	2
7	PAOZZ	45152	354AX	WASHER,LOCK	6
8	PAFZZ	45152	1367HX1	SCREW,CAP,HEX HD	2
9	PAFZZ	96906	MS51849-74	SCREW,MACHINE	4
10	PAFZZ	78519	1571850	NUT,SLFLKG,ASSY WASH	4
11	PFFZZ	45152	1862530W	MAIN JUNCTION BOX L	1
12	PAFZZ	45152	736HX1	SCREW,CAP,HEX HD	8
13	PAFZZ	45152	351AX	WASHER,LOCK	8
14	PFFZZ	45152	2048840W	BRACKET,RH	1
15	PAFZZ	52167	WC0412PB	BOLT,MACHINE	3
16	PAOZZ	75272	COV2113	CLAMP,LOOP	2
17	PAOZZ	45152	3737FX3	CLIP,BRACKET,HEATER	1
18	PAFZZ	53606	CJV-0809	J-CLIP,	1
19	PAFZZ	45152	1606140	SCREW,CAP,HEX HD	1
20	PAOZZ	45152	1600460	NUT,HEX	9
21	PAOZZ	45152	1754140	SCREW,CAP HEX HD	1
22	PFFZZ	45152	3053657	BRACKET,DOUBLE ANGL	1
23	PAOZZ	82458	T893R	NUT,SELF-LOCKING, H	9
24	PAFZZ	45152	1754280	SCREW,CAP,HEX HD	5
25	PFFZZ	45152	2048850W	BRACKET,LH	1
26	PFFZZ	45152	3053658	BRACKET,DOUBLE ANGL	1
27	PAOZZ	45152	362AX	WASHER,PLAIN,FLAT	8
28	PAOZZ	96906	MS51105-367	SCREW,CAP,HEX HD	8
29	PAOZZ	45152	50619AX	SCREW,CAP,HEX HD	6
30	PAOZZ	52167	WC0414PB	BOLT,MACHINE	2
31	PAOZZ	45152	1862510W	BRACKET MOUNTING	1

END OF FIGURE

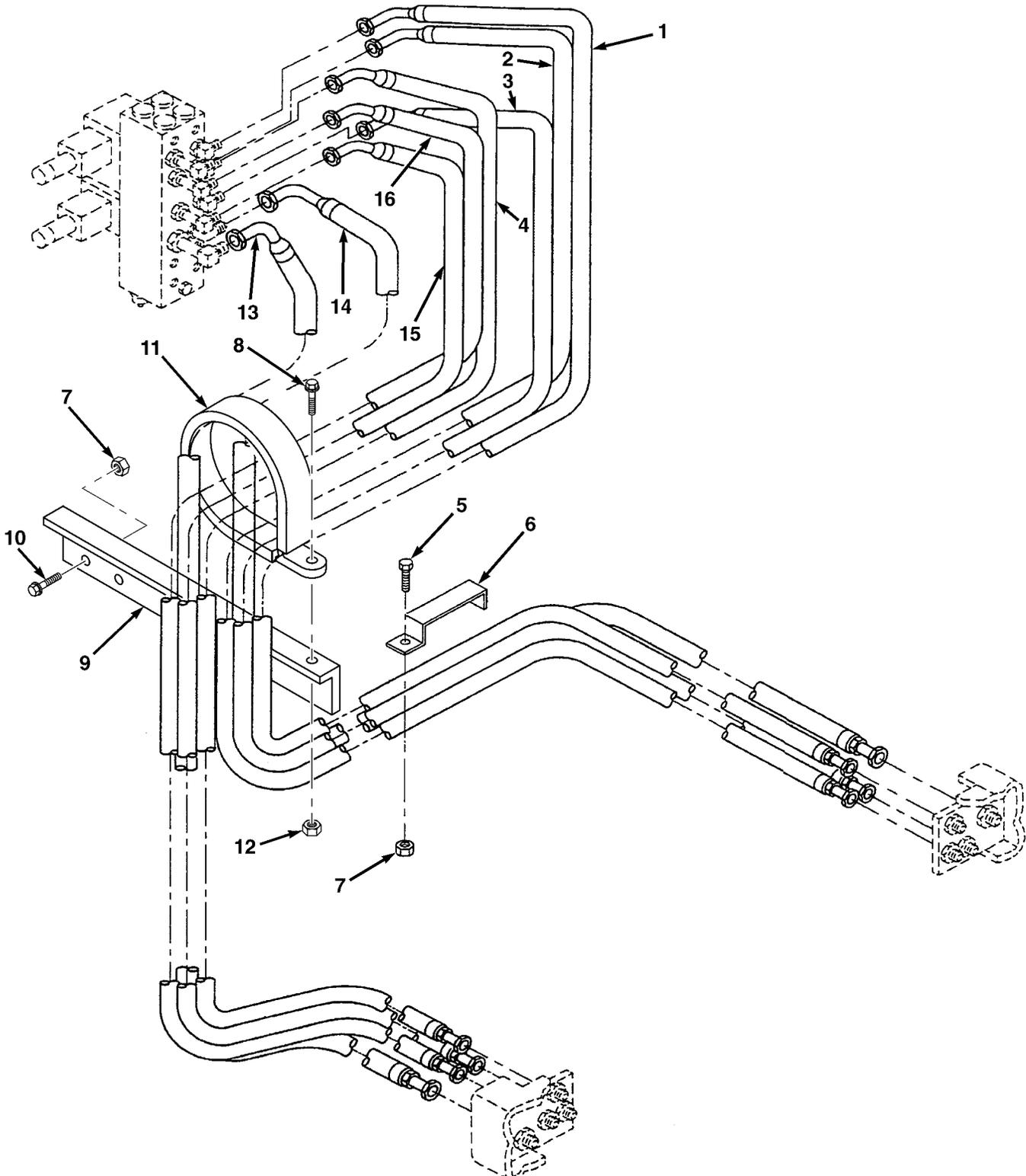

FIG. 35 LHS MAIN MANIFOLD TO COMPRESSION FRAME HOSES

SECTION II

TM 9-2320-304-14&P

(1) ITEM NO	(2) SMR CODE	(3) CAGEC CAGEC	(4) PART NUMBER	(5) DESCRIPTION AND USABLE ON CODES(UOC)	(6) QTY
GROUP 2406 STRAINERS, FILTERS, LINES, AND FITTINGS, ETC. FIG. 35 LHS MAIN MANIFOLD TO COMPRESSION FRAME HOSES					
1	PAFZZ	45152	3056242	HOSE ASSEMBLY, NONME	1
2	PAFZZ	45152	3056245	HOSE ASSEMBLY, NONME	1
3	PAFZZ	45152	3056240	HOSE ASSEMBLY, NONME	1
4	PAFZZ	45152	3056244	HOSE ASSEMBLY, NONME	1
5	PAOZZ	45152	1756870	BOLT, MACHINE	1
6	PAOZZ	45152	1779770	BRACKET	1
7	PAOZZ	45152	1333510	NUT, SELF-LOCKING, EX	3
8	PAOZZ	45152	1614120	SCREW, CAP, HEX	1
9	PAFZZ	45152	3057867	BRACKET, HOSE CLAMP	1
10	PAFZZ	45152	1754210	SCREW, CAP, HEX HD	2
11	PAFZZ	84971	TA720S24	CLIP, CUSHIONED	1
12	PAOZZ	45152	1437220	NUT, HEX	1
13	PAFZZ	45152	3056238	HOSE ASSEMBLY	1
14	PAFZZ	45152	3056239	HOSE ASSEMBLY	1
15	PAFZZ	45152	3056243	HOSE ASSEMBLY	1
16	PAFZZ	45152	3056241	HOSE ASSEMBLY	1

END OF FIGURE

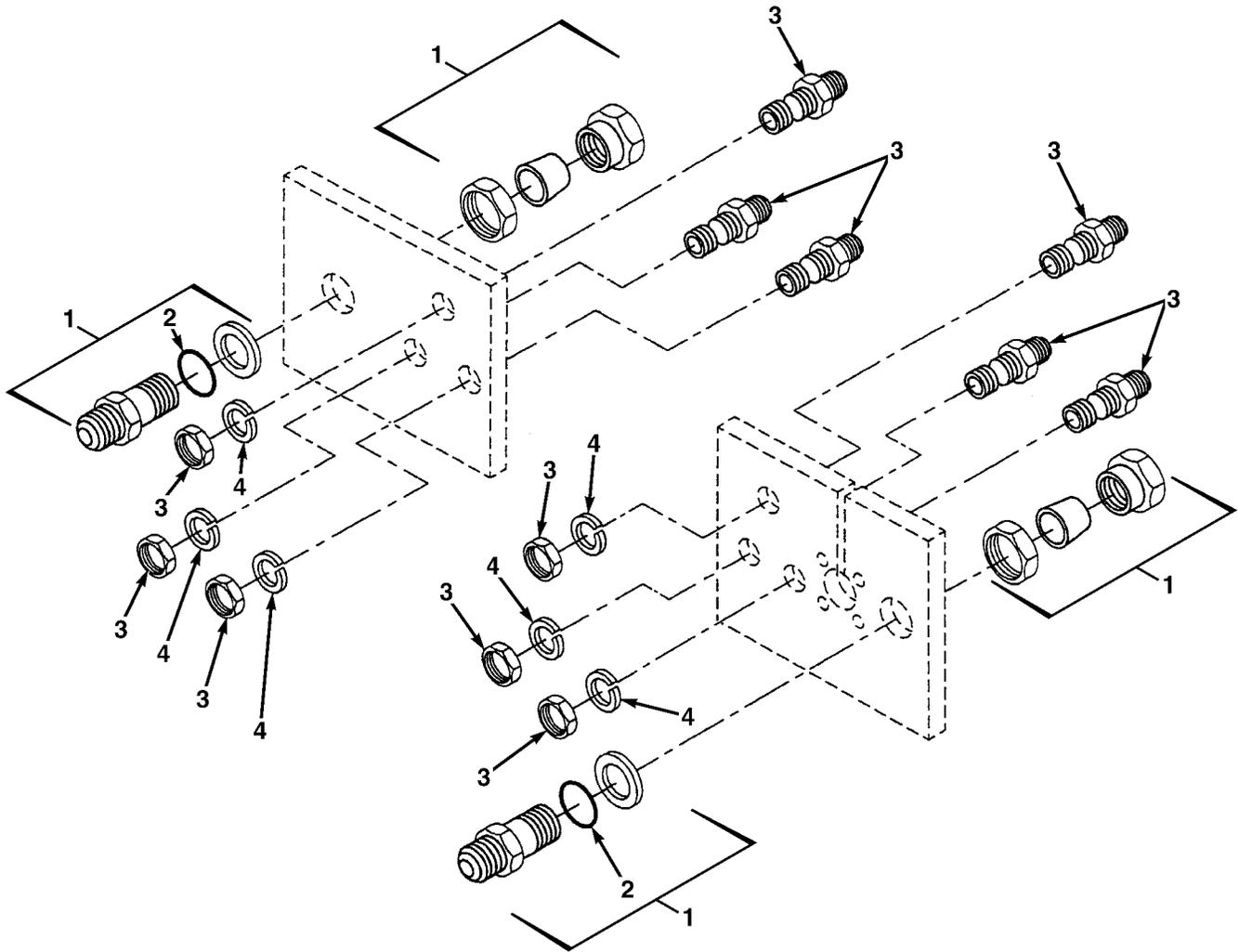

FIG. 36 LHS COMPRESSION FRAME BULKHEAD CONNECTORS

SECTION II

TM 9-2320-304-14&P

(1) ITEM NO	(2) SMR CODE	(3) CAGEC	(4) PART NUMBER	(5) DESCRIPTION AND USABLE ON CODES(UOC)	(6) QTY
				GROUP 2406 STRAINERS, FILTERS, LINES, AND FITTINGS, ETC. FIG. 36 LHS COMPRESSION FRAME BULKHEAD CONNECTORS	
1	PAFZZ	K0274	A16-17J1CBHR	UNION,BULKHEAD	2
2	PAFZZ	K0274	200-214-4490	.PACKING,PREFORMED	1
3	PAFZZ	96906	MS51520A8S	ADAPTER,STRAIGHT, TU	6
4	PAFZZ	96906	MS35338-138	WASHER,LOCK	6

END OF FIGURE

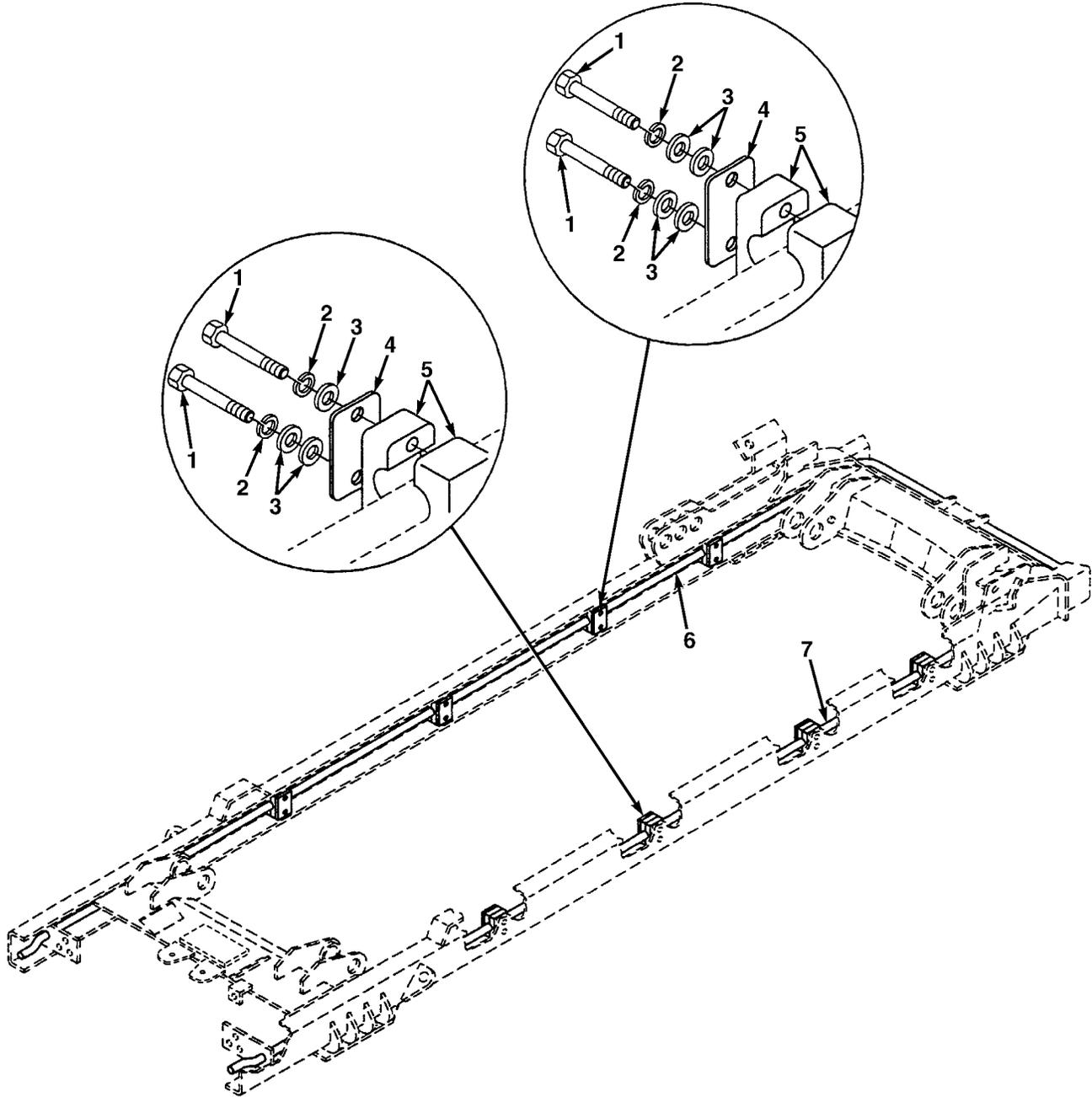

FIG. 37 LHS COMPRESSION FRAME TUBES AND MOUNTINGS

SECTION II

TM 9-2320-304-14&P

(1) ITEM NO	(2) SMR CODE	(3) CAGEC CAGEC	(4) PART NUMBER	(5) DESCRIPTION AND USABLE ON CODES(UOC)	(6) QTY
GROUP 2406 STRAINERS, FILTERS, LINES, AND FITTINGS, ETC.					
FIG. 37 LHS COMPRESSION FRAME TUBES AND MOUNTINGS					
1	PAFZZ	45152	1337630	SCREW,CAP,HEX HD	16
2	PAFZZ	46906	MS35338-44	WASHER,LOCK	16
3	PAFZZ	96906	MS27183-10	WASHER,FLAT	28
4	PFFZZ	53790	DP-3	COVER,ACCESS	8
5	PFFZZ	53790	3254PA	CLAMP	8
6	PFFZZ	45152	1862620	TUBE,FRAME COMPRESS	1
7	PFFZZ	45152	1862610	TUBE,FRAME COMPRESS	1

END OF FIGURE

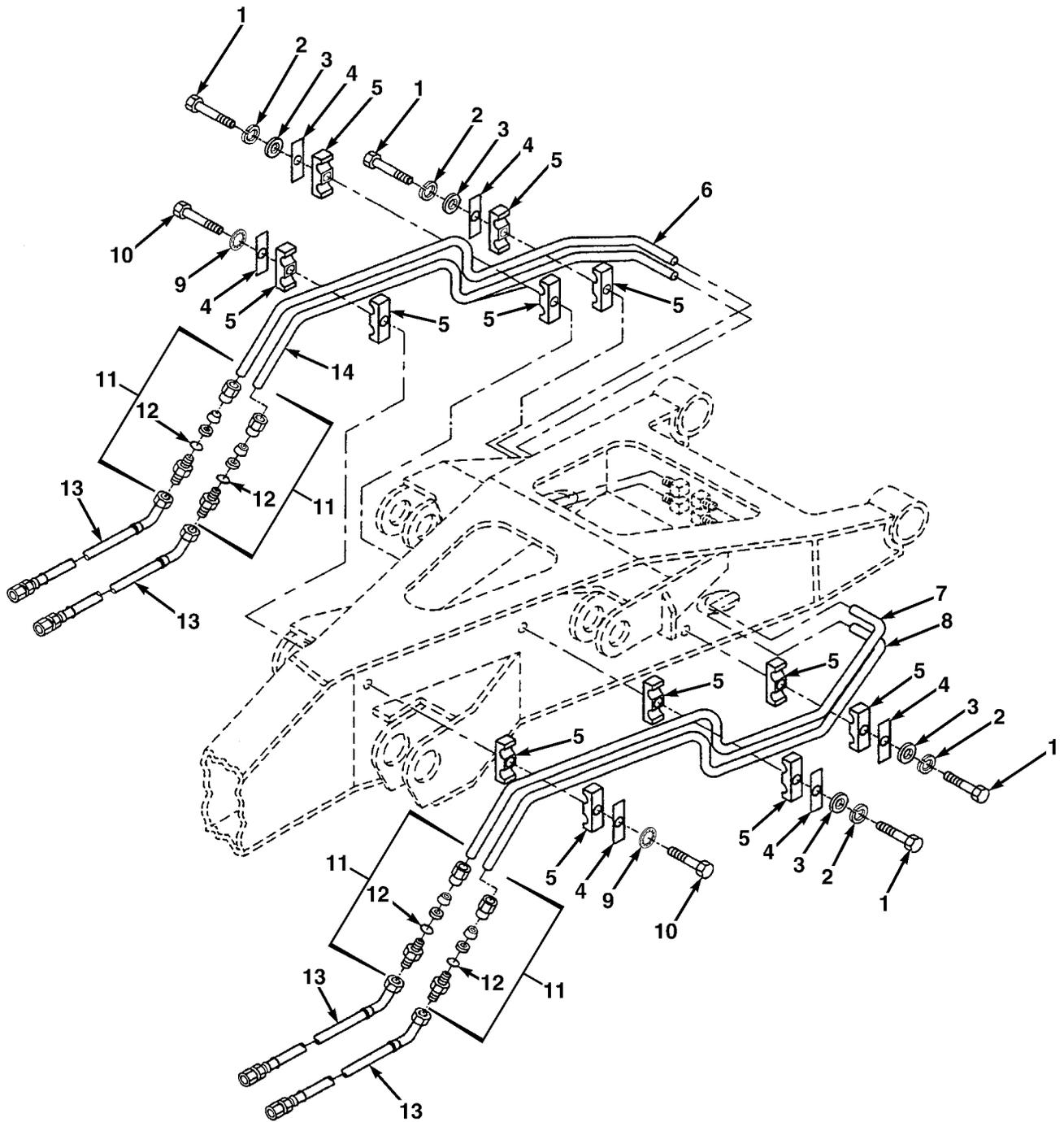

FIG. 38 LHS MIDDLE FRAME HYDRAULIC LINES AND HOSES

SECTION II

TM 9-2320-304-14&P

(1) ITEM NO	(2) SMR CODE	(3) CAGEC CAGEC	(4) PART NUMBER	(5) DESCRIPTION AND USABLE ON CODES(UOC)	(6) QTY
GROUP 2406 STRAINERS, FILTERS, LINES, AND FITTINGS, ETC. FIG. 38 LHS MIDDLE FRAME HYDRAULIC LINES AND HOSES					
1	PFFZZ	96906	MS35307-340	BOLT,MACHINE	4
2	PAFZZ	45152	354AX	WASHER,LOCK	4
3	PAFZZ	45152	1804HX	WASHER,FLAT	4
4	PFFZZ	53790	GD-3D	CLAMP,COVER	6
5	PFFZZ	53790	3190/190-PA	CLAMP,TWIN	6
6	PFFZZ	45152	1862600	TUBE, TOP RH HOOK AR	1
7	PFFZZ	45152	1862580	TUBE, TOP LH HOOK AR	1
8	PFFZZ	45152	1862570	TUBE, LH HOOK ARM BO	1
9	PAFZZ	45152	2150HX1	SAE INTERNAL LOCKWA	2
10	PFFZZ	45152	1849HX1	BOLT,MACHINE	2
11	PFFZZ	K0274	A12-12JICMSCR	UNION	4
12	PFFZZ	K0274	200-116-4490	.PACKING,PREFORMED	1
13	PFOZZ	01276	FK1328HHH0224	HOSE ASSY	4
14	PFFZZ	45152	1862590	TUBE,RH HOOK ARM BO	1

END OF FIGURE

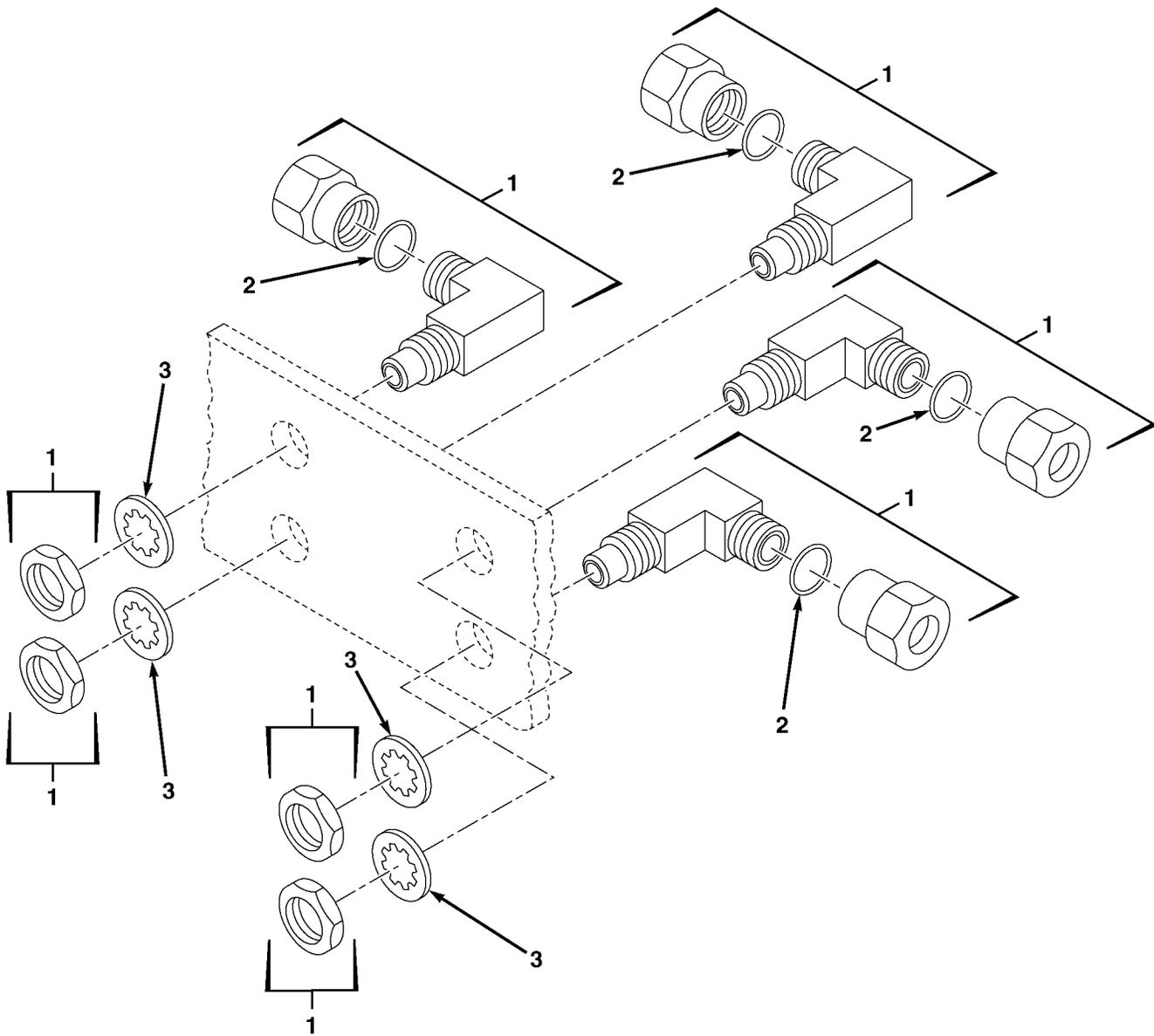

FIG. 39 LHS MIDDLE FRAME BULKHEAD CONNECTORS

SECTION II			TM 9-2320-304-14&P		
(1)	(2)	(3)	(4)	(5)	(6)
ITEM	SMR		PART		
NO	CODE	CAGEC	NUMBER	DESCRIPTION AND USABLE ON CODES(UOC)	QTY
				GROUP 2406 STRAINERS, FILTERS, LINES, AND FITTINGS, ETC. FIG. 39 LHS MIDDLE FRAME BULKHEAD CONNECTORS	
1	PFFZZ	K0274	A12-12JICBHMER	ELBOW,BULKHEAD	4
2	PFFZZ	K0274	200-116-4490	.PACKING,PREFORMED	1
3	PAFZZ	96906	MS35338-138	WASHER,LOCK	4

END OF FIGURE

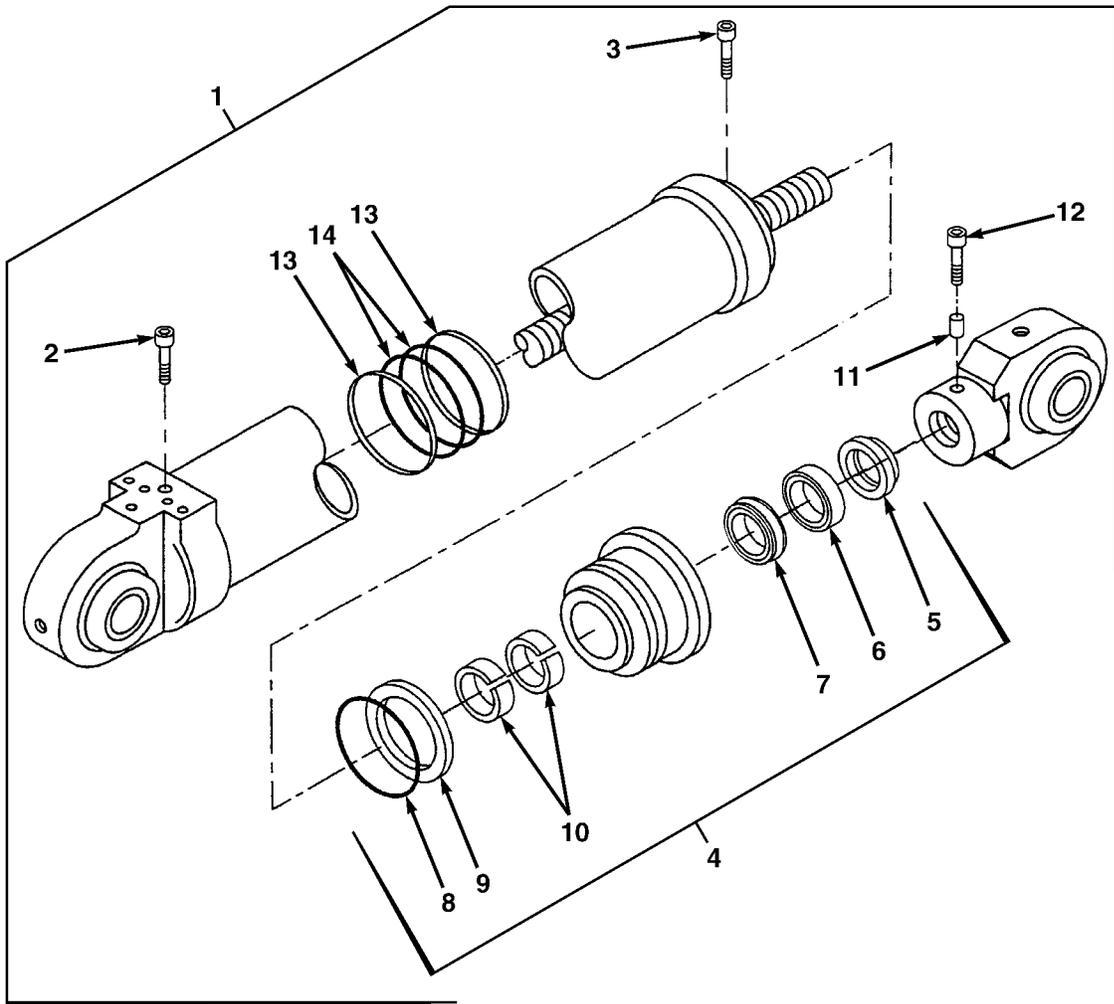

FIG. 40 LHS MAIN CYLINDER

SECTION II

TM 9-2320-304-14&P

(1) ITEM NO	(2) SMR CODE	(3) CAGEC CAGEC	(4) PART NUMBER	(5) DESCRIPTION AND USABLE ON CODES(UOC)	(6) QTY
GROUP 2406 STRAINERS, FILTERS, LINES, AND FITTINGS, ETC. FIG. 40 LHS MAIN CYLINDER					
1	PFFFF	63899	150235B	CYLINDER ASSY,MAIN	1
2	PFFZZ	63899	711009A	.SCREW,CAP,HEX	1
3	PFFZZ	63899	711053A	.SCREW,CAP	4
4	PFFFF	63899	500419B	.BEARING ASSY,ROD	1
5	KFFZZ	63899	702001A	..WIPER,ROD PART OF KIT P/N 430457B ..	1
6	KFFZZ	63899	701121A	..SEAL,ROD PART OF KIT P/N 430457B ...	1
7	KFFZZ	63899	706069A	..STEP SEAL,K-R ASSY PART OF KIT P/N 430457B	1
8	KFFZZ	63899	703425A	..PACKING,PREFORMED PART OF KIT P/N 430457B	1
9	KFFZZ	63899	704425A	..RING,BACKUP PART OF KIT P/N 430457B	1
10	KFFZZ	63899	721175A	..RING,WEAR PART OF KIT P/N 430457B ..	2
11	PFFZZ	63899	715001A	.PLUG,NYLON	1
12	PFFZZ	63899	711083A	.SCREW,CAP	1
13	KFFZZ	63899	721176A	.RING,WEAR PART OF KIT P/N 430457B ...	2
14	KFFZZ	63899	700079A	.SEAL ASSY,PISTON PART OF KIT P/N 430457B	1

END OF FIGURE

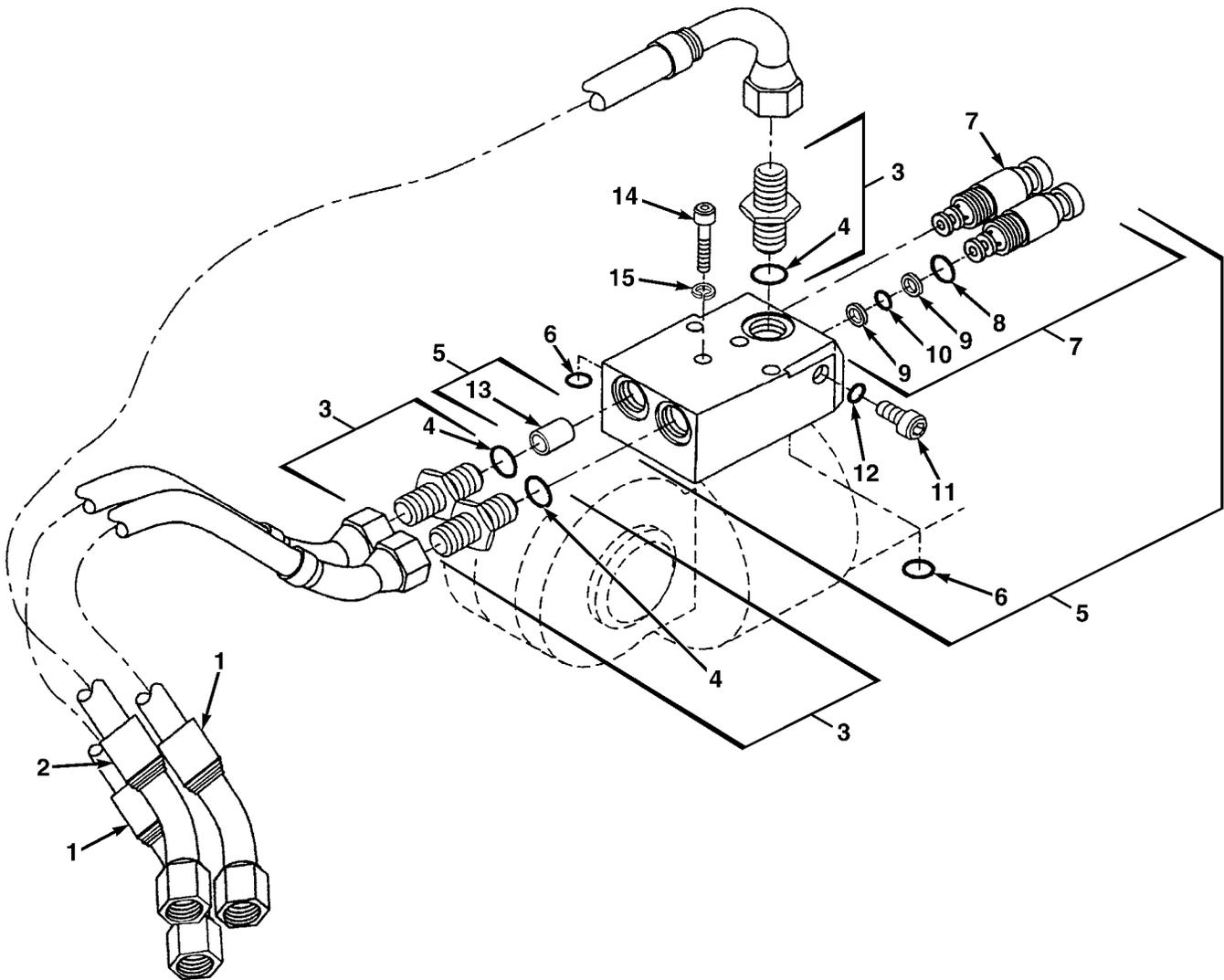

FIG. 41 LHS MAIN CYLINDER MANIFOLD

SECTION II

TM 9-2320-304-14&P

(1) ITEM NO	(2) SMR CODE	(3) CAGEC CAGEC	(4) PART NUMBER	(5) DESCRIPTION AND USABLE ON CODES(UOC)	(6) QTY
GROUP 2406 STRAINERS, FILTERS, LINES, AND FITTINGS, ETC. FIG. 41 LHS MAIN CYLINDER MANIFOLD					
1	PFOZZ	01276	FU680HHH0260180	HOSE ASSY	2
2	PFOZZ	01276	FU681HHH0300180	HOSE ASSY	1
3	PFFZZ	01276	202702-12-8S	ADAPTER,STRAIGHT TU	3
4	PFFZZ	01276	22617-12	.PACKING,PREFORMED	1
5	PBFFF	0FHH8	8F3930	MANIFOLD,MAIN CYL IN	1
6	PFFZZ	0FHH8	8023N7013	.PACKING,PREFORMED PART OF KIT P/N 9S000105	1
7	PAFZZ	0FHH8	A5B060014350N	.VALVE,RELIEF	2
8	KFFZZ	0FHH8	8024N908	..PACKING,PREFORMED PART OF KIT P/N SK3-0017N-1	1
9	KFFZZ	0FHH8	8025N9011	..RING,BACKUP PART OF KIT P/N SK3-0017N-1	2
10	KFFZZ	0FHH8	8022N7011	..PACKING,PREFORMED PART OF KIT P/N SK3-0017N-1	1
11	PFFZZ	0FHH8	801004M	.PLUG,HEX,HOLLOW	1
12	KFFZZ	0FHH8	8024N905	.PACKING,PREFORMED PART OF KIT P/N 9S000105	1
13	PAFZZ	0FHH8	9DD000140	.VALVE,SAFETY,RELIEF	2
14	PAFZZ	45152	3064801	SCREW,CAP,SOCKET HD	4
15	PAFZZ	45152	1937550	WASHER,LOCK	4

END OF FIGURE

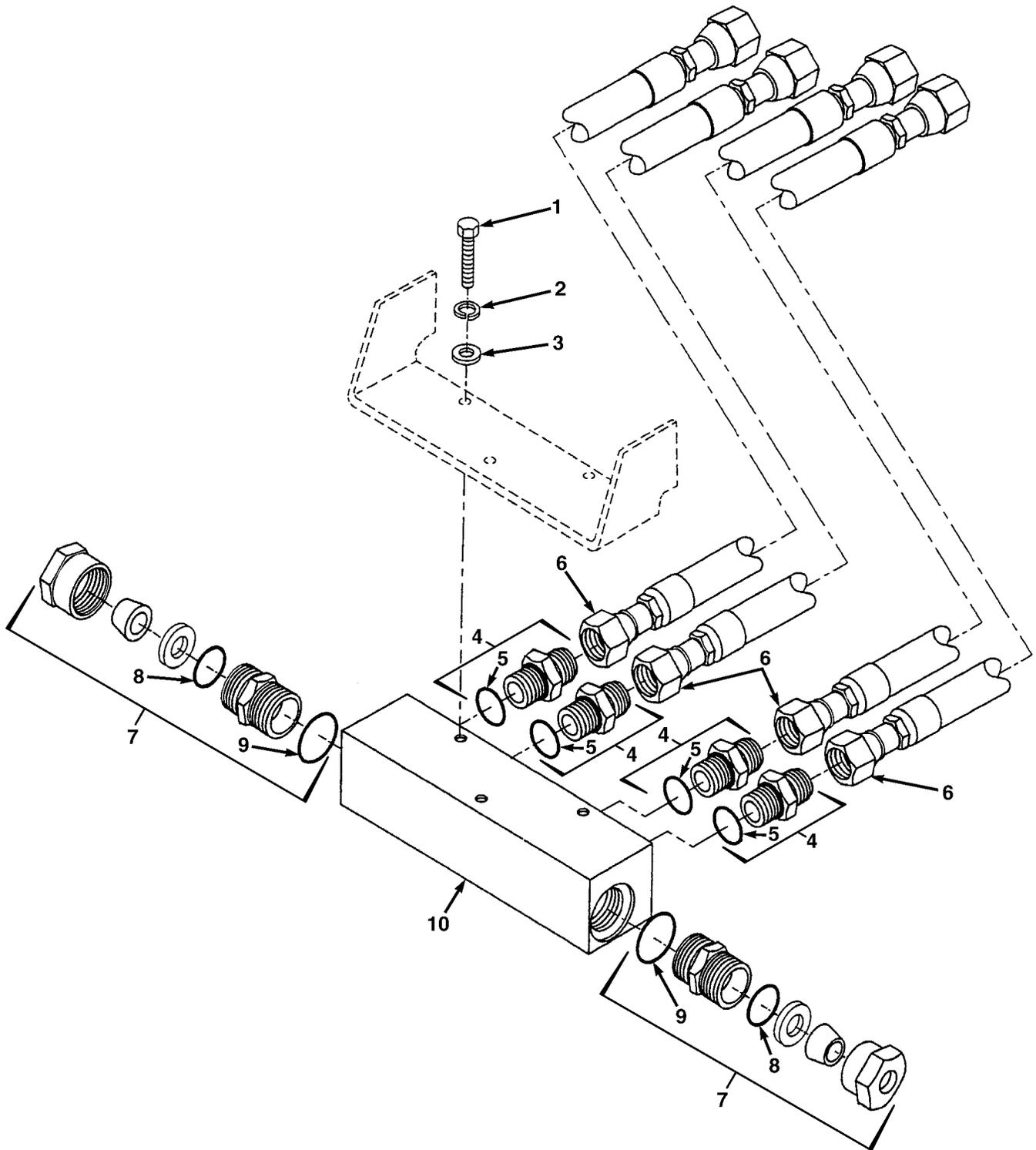

FIG. 42 LHS DIVERTER MANIFOLD

SECTION II

TM 9-2320-304-14&P

(1) ITEM NO	(2) SMR CODE	(3) CAGEC CAGEC	(4) PART NUMBER	(5) DESCRIPTION AND USABLE ON CODES(UOC)	(6) QTY
GROUP 2406 STRAINERS, FILTERS, LINES, AND FITTINGS, ETC. FIG. 42 LHS DIVERTER MANIFOLD					
1	PAFZZ	45152	1846HX1	BOLT,MACHINE	3
2	PAFZZ	11939	93613642	WASHER,LOCK	3
3	PAFZZ	45152	1804HX	WASHER,FLAT	3
4	PAFZZ	81343	8-8 070120CA	ADAPTER,STRAIGHT	4
5	PAFZZ	01276	22617-8	.PACKING,PREFORMED	1
6	PFOZZ	01276	FK1329HHH0244	HOSE ASSY	4
7	PFFZZ	K0274	A16-17DBMSCR	COUPLING,MALE STUD	2
8	PFFZZ	K0274	200-214-4490	.PACKING,PREFORMED	1
9	PFFZZ	K0274	200-912-4490	.PACKING,PREFORMED	1
10	PFFZZ	45152	1891380	MANIFOLD,DIVERTER	1

END OF FIGURE

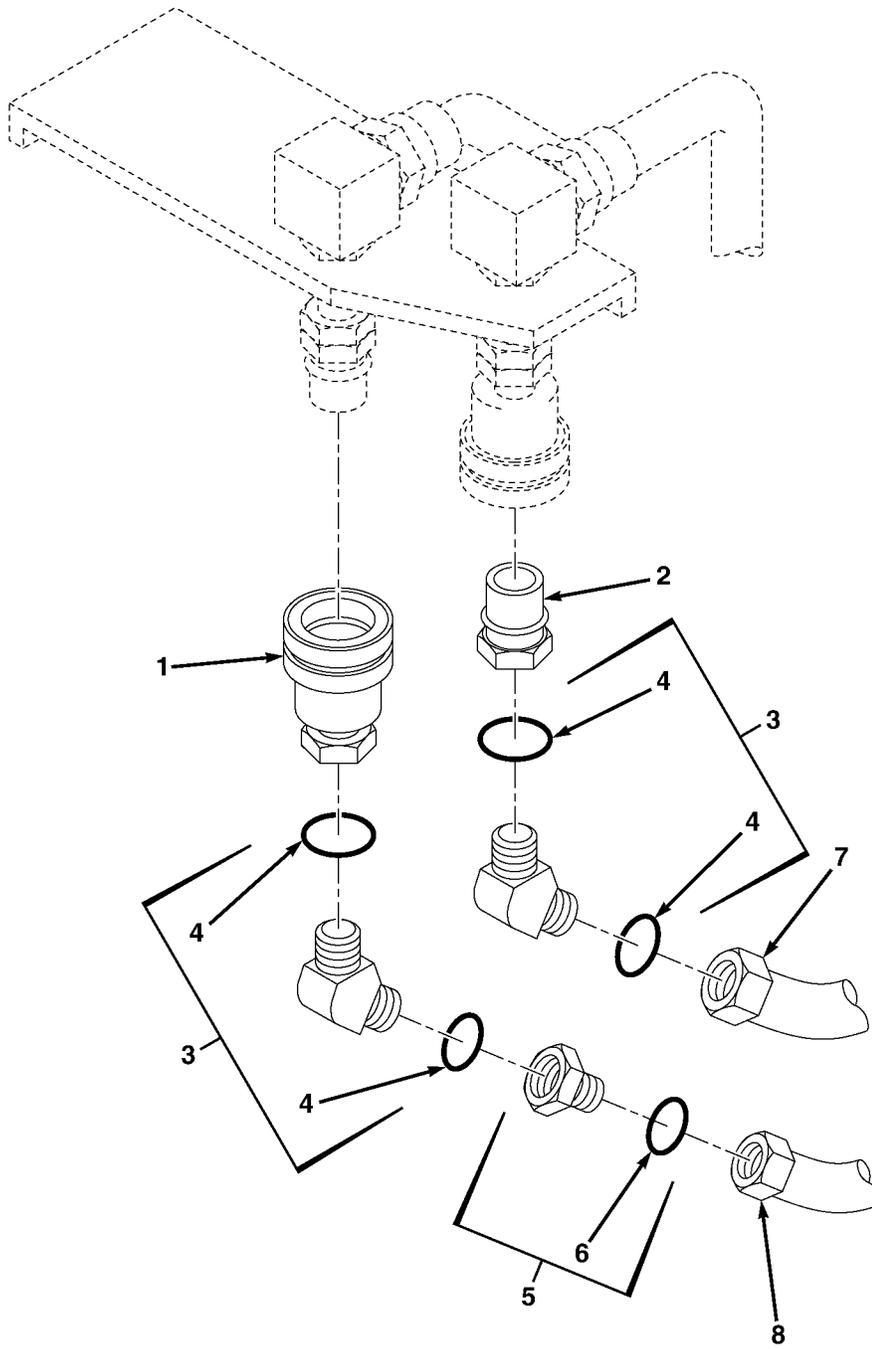

FIG. 43 LHS DISCONNECT ADAPTERS

SECTION II

TM 9-2320-304-14&P C01

(1) ITEM NO	(2) SMR CODE	(3) CAGEC CAGEC	(4) PART NUMBER	(5) DESCRIPTION AND USABLE ON CODES(UOC)	(6) QTY
GROUP 2406 STRAINERS, FILTERS, LINES, AND FITTINGS, ETC. FIG. 43 LHS DISCONNECT ADAPTER					
1	PFFZZ	01276	PD45-1169-16-16	COUPLING HALF,QUICK	1
2	PFFZZ	01276	FD45-1168-16-16	COUPLING HALF,QUICK	1
3	PFFOO	81343	16-16 080320CA	ELBOW	2
4	PFFZZ	01276	22617-8	.O-RING	2
5	PFFZZ	01276	221501-16-12S	REDUCER,ADAPTER, FIT	1
6	PAFZZ	01276	22617-12	.PACKING,PREFORMED	1
7	PFFZZ	45152	1456530	HOSE ASSEMBLY	1
8	PFFZZ	45152	3056237	HOSE ASSEMBLY	1

END OF FIGURE

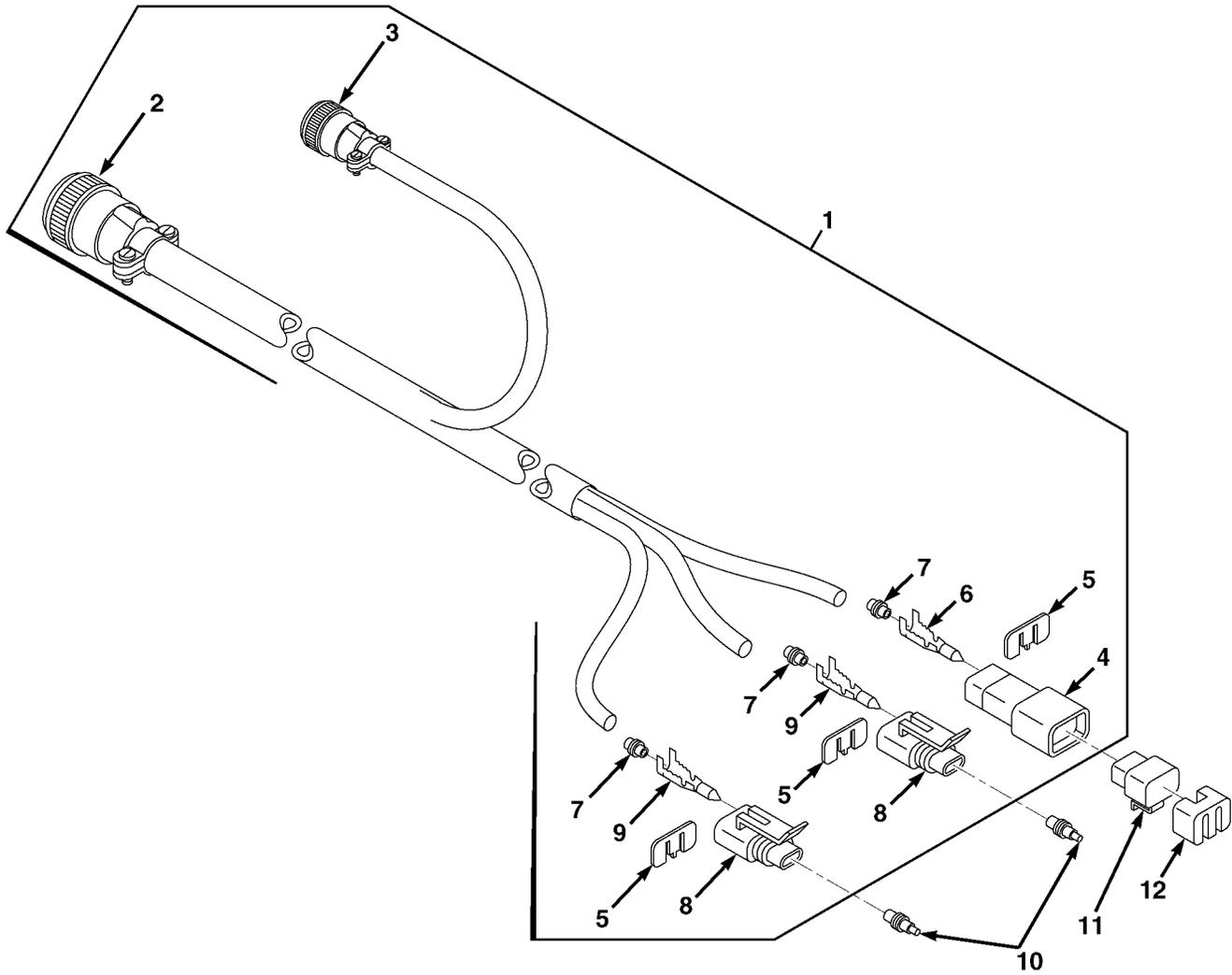

FIG. 44 SENSOR HARNESS

SECTION II

TM 9-2320-304-14&P C01

(1) ITEM NO	(2) SMR CODE	(3) CAGEC CAGEC	(4) PART NUMBER	(5) DESCRIPTION AND USABLE ON CODES(UOC)	(6) QTY
GROUP 3307 SPECIAL PURPOSE KIT					
FIG. 44 SENSOR HARNESS					
1	PAOOO	45152	3181842	CABLE ASSY,POWER,EL	1
				UOC: LHU	
2	PBOZZ	71468	CA3106F18-1PF80	.CONNECTOR	1
				UOC: LHU	
3	PBOZZ	71468	CA3106F10SL-3SF80	.CONNECTOR	1
				UOC: LHU	
4	PBOZZ	64678	1530 0002	.BODY,CONNECTOR	1
				UOC: LHU	
5	PFOZZ	77060	15300014	.LOCK,SECONDARY	3
				UOC: LHU	
6	PAOZZ	77060	12048159	.TERMINAL	2
				UOC: LHU	
7	PAOZZ	77060	12010293	.BOOT,DUST	6
				UOC: LHU	
8	PBOZZ	77060	15300027	.CONNECTOR	2
				UOC: LHU	
9	PAOZZ	77060	12077411	.TERMINAL,FEMALE	4
				UOC: LHU	
10	PAOZZ	77060	12010300	SEAL,PLUG	2
				UOC: LHU	
11	PAOZZ	77060	15300027	HOUSING,CONNECTOR	1
				UOC: LHU	
12	PAOZZ	77060	15300014	LOCK,SECONDARY	1
				UOC: LHU	

END OF FIGURE

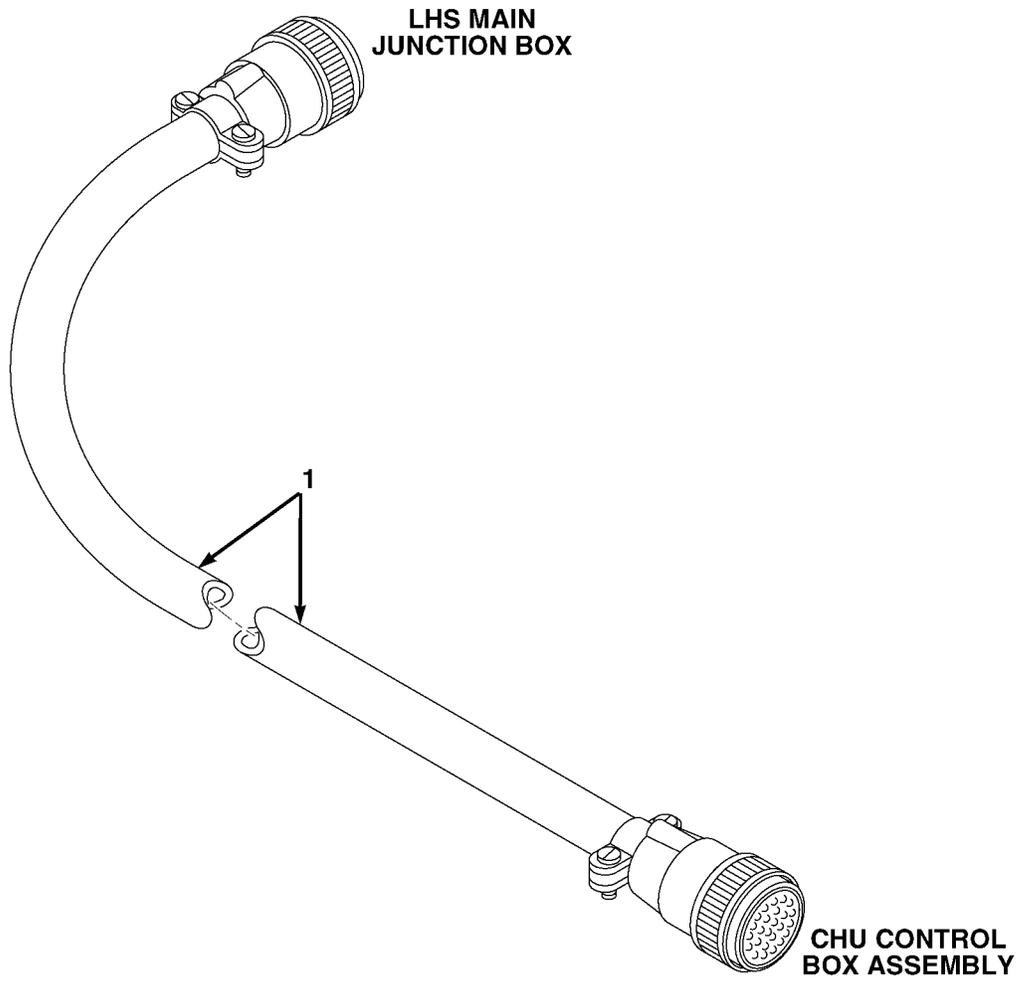

FIG. 45 JUMPER HARNESS

SECTION II

TM 9-2320-304-14&P C01

(1) ITEM NO	(2) SMR CODE	(3) CAGEC	(4) PART NUMBER	(5) DESCRIPTION AND USABLE ON CODES (UOC)	(6) QTY
				GROUP 3307 SPECIAL PURPOSE KIT FIG. 45 JUMPER HARNESS	
1	PAOZZ	45152	3135770	CABLE ASSY, POWER, EL UOC: LHU	1

END OF FIGURE

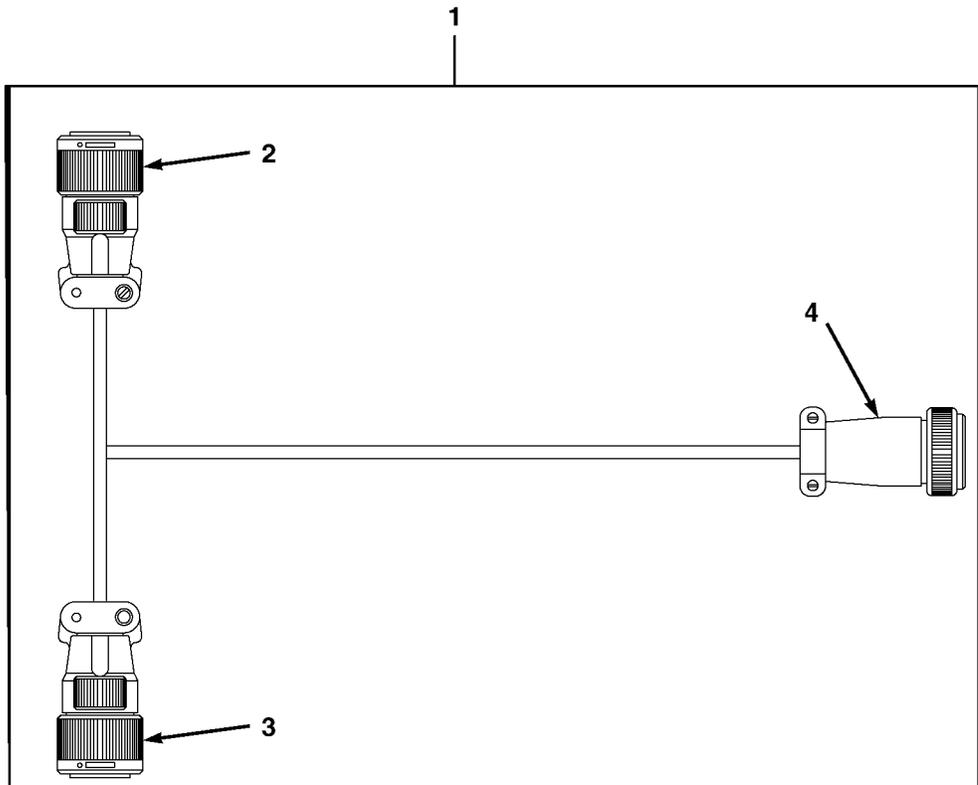

FIG. 46 PROXIMITY SWITCH HARNESS

SECTION II

TM 9-2320-304-14&P C01

(1) ITEM NO	(2) SMR CODE	(3) CAGEC CAGEC	(4) PART NUMBER	(5) DESCRIPTION AND USABLE ON CODES(UOC)	(6) QTY
GROUP 3307 SPECIAL PURPOSE KIT					
FIG. 46 PROXIMITY SWITCH HARNESS					
1	PAOOO	45152	3353067	HARNESS,PROXIMITY SWITCH	1
				UOC: LHU	
2	PHOZZ	71468	CA3106F18-1PF80	.CONNECTOR	1
				UOC: LHU	
3	PAOZZ	71468	CA3101F18-1SF80	.CONNECTOR	1
				UOC: LHU	
4	PAOZZ	71468	CA3106F10SL-3SF80	.CONNECTOR	1
				UOC: LHU	

END OF FIGURE

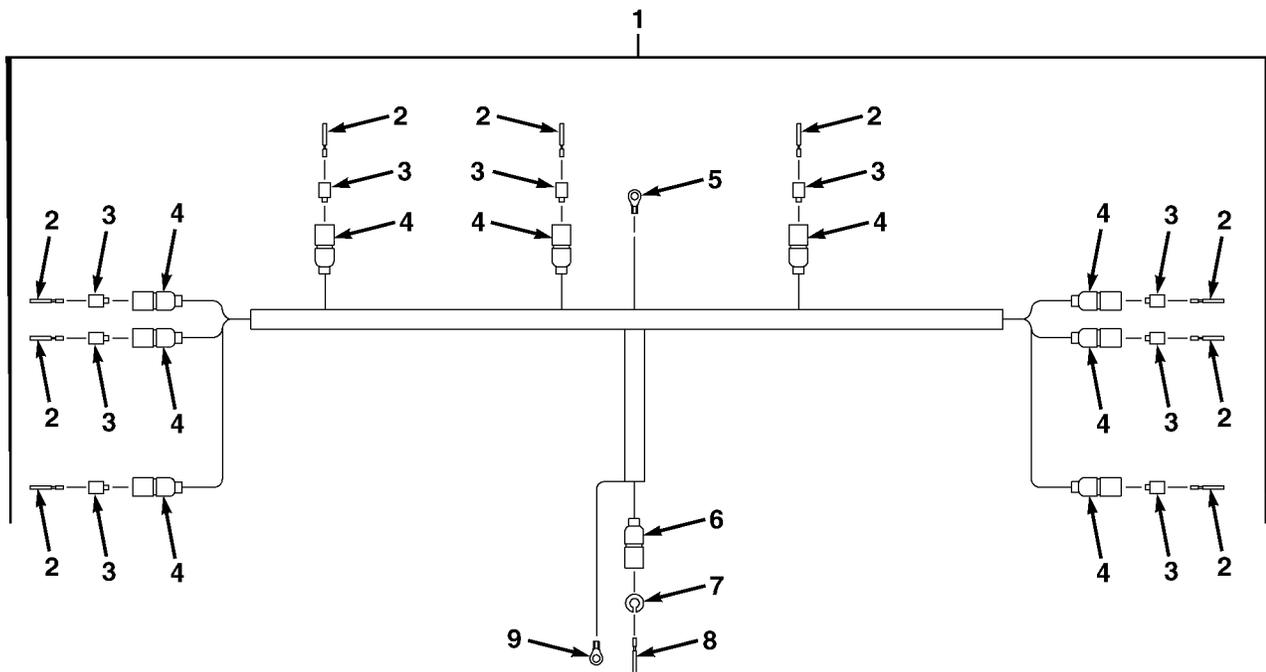

FIG. 47 CLEARANCE LIGHT WIRING HARNESS REAR

SECTION II

TM 9-2320-304-14&P C01

(1) ITEM NO	(2) SMR CODE	(3) CAGEC CAGEC	(4) PART NUMBER	(5) DESCRIPTION AND USABLE ON CODES(UOC)	(6) QTY
GROUP 3307 SPECIAL PURPOSE KIT					
FIG. 47 CLEARANCE LIGHT WIRING HARNESS					
REAR					
1	PAOOO	45152	3349086	WIRING HARNESS	1
				UOC: LHU	
2	PAOZZ	19207	8338564	.TERMINAL SET	9
				UOC: LHU	
3	PAOZZ	19207	8338562	.INSULATOR,BUSHING	9
				UOC: LHU	
4	PAOZZ	19207	8724494	.CABLE NIPPLE,ELECTR	9
				UOC: LHU	
5	PAOZZ	96906	MS25036-157	.TERMINAL,LUG	1
				UOC: LHU	
6	PAOZZ	97403	13207E6498-2	.SHELL,ELECTRICAL CO	1
				UOC: LHU	
7	PAOZZ	19207	8338567	.WASHER,SLOTTED	1
				UOC: LHU	
8	PAOZZ	19204	572929	.CONTACT,ELECTRICAL	1
				UOC: LHU	
9	PAOZZ	96906	MS25036-113	.TERMINAL,LUG	1
				UOC: LHU	

END OF FIGURE

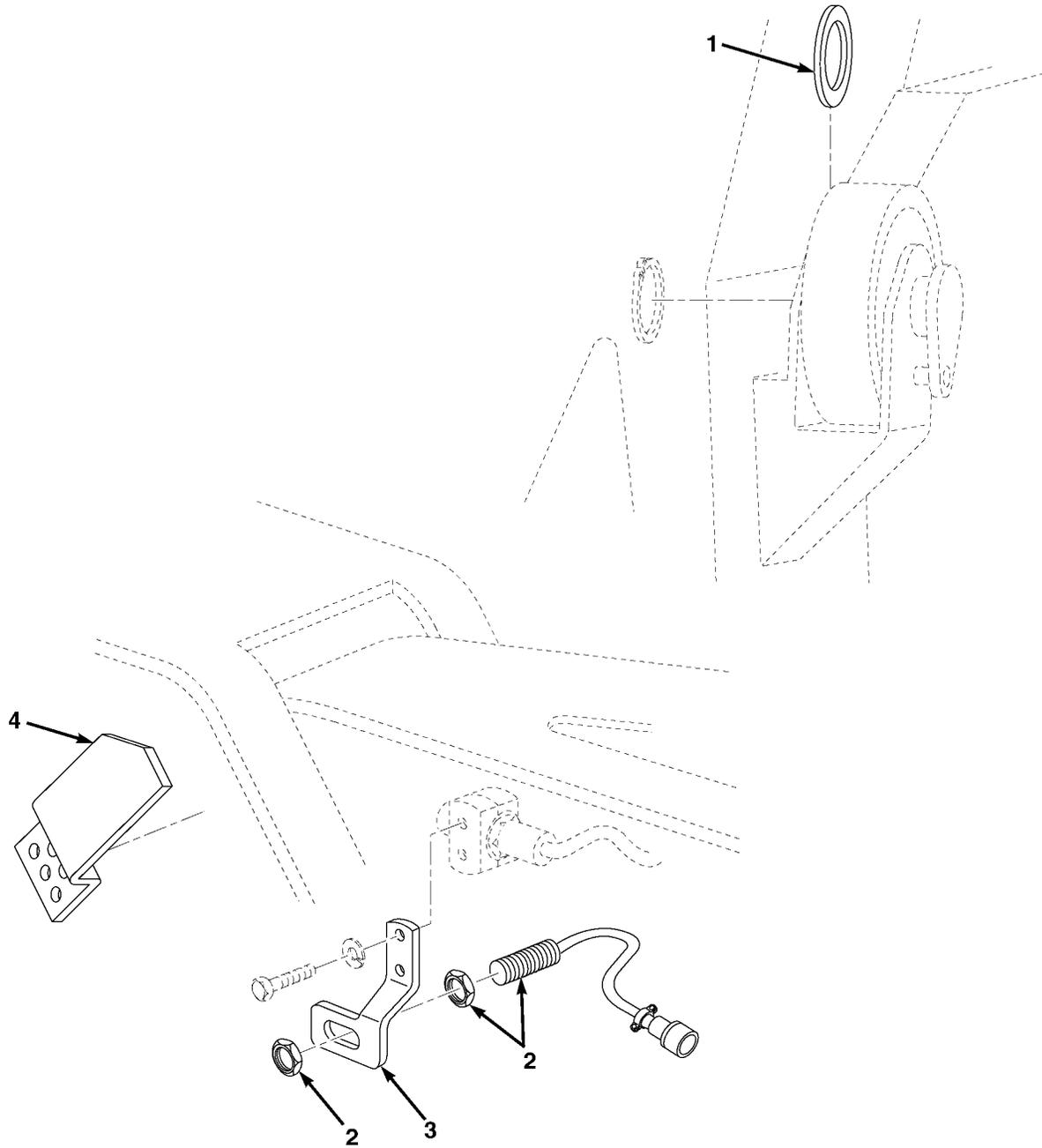

FIG. 48 PROXIMITY SWITCH

SECTION II

TM 9-2320-304-14&P C01

(1) ITEM NO	(2) SMR CODE	(3) CAGEC CAGEC	(4) PART NUMBER	(5) DESCRIPTION AND USABLE ON CODES(UOC)	(6) QTY
GROUP 3307 SPECIAL PURPOSE KIT					
FIG. 48 PROXIMITY SWITCH					
1	PFOZZ	45152	2221970	SHIM	2
				UOC: LHU	
2	PAOZZ	45152	3135832	SWITCH ASSY, PROXIMITY	1
				UOC: LHU	
3	PFOZZ	45152	3122223	PLATE, MOUNTING SWITCH	1
				UOC: LHU	
4	PFOZZ	45152	2265340	PLATE, MOUNTING	1
				UOC: LHU	

END OF FIGURE

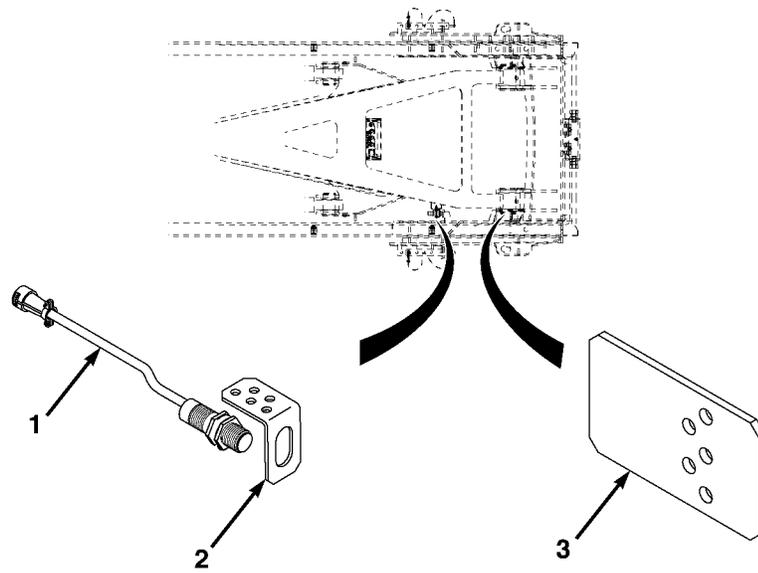

FIG. 49 MAIN CYLINDER PROXIMITY SWITCH

SECTION II

TM 9-2320-304-14&P C01

(1) ITEM NO	(2) SMR CODE	(3) CAGEC CAGEC	(4) PART NUMBER	(5) DESCRIPTION AND USABLE ON CODES(UOC)	(6) QTY
GROUP 3307 SPECIAL PURPOSE KIT					
FIG. 49 MAIN CYLINDER PROXIMITY SWITCH					
1	PAOZZ	45152	3135832	SWITCH,PROXIMITY	1
				UOC: LHU	
2	PFOZZ	45152	3353063	MTG PLATE,PROXIMITY SWITCH	1
				UOC: LHU	
3	PFOZZ	45152	3353061	PLATE,SENSING	1
				UOC: LHU	

END OF FIGURE

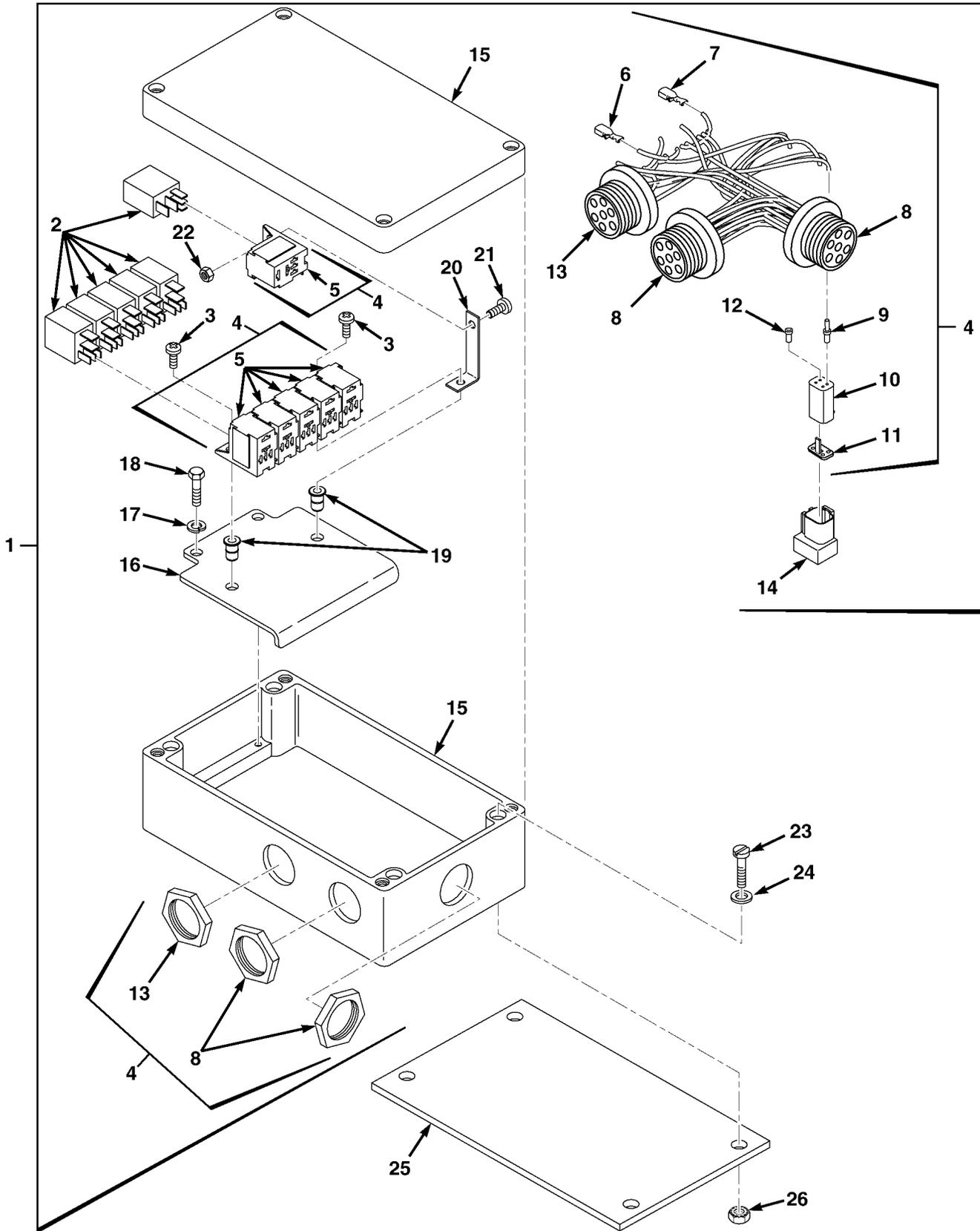

FIG. 50 CONTROL BOX

SECTION II

TM 9-2320-304-14&P C01

(1) ITEM NO	(2) SMR CODE	(3) CAGEC CAGEC	(4) PART NUMBER	(5) DESCRIPTION AND USABLE ON CODES(UOC)	(6) QTY
GROUP 3307 SPECIAL PURPOSE KIT					
FIG. 50 CONTROL BOX					
1	PBOOO	45152	3353059	CONTROL BOX ASSY	1
				UOC: LHU	
2	PAOZZ	53867	0332207402	.RELAY,MICRO	6
				UOC: LHU	
3	PAOZZ	45152	59030AX	.SCREW,PAN HEAD	2
				UOC: LHU	
4	PBOOO	45152	3353069	.HARNES,CONTROL BOX	1
				UOC: LHU	
5	PAOZZ	53867	3334485045	..SOCKET,MICRO RELAY	6
				UOC: LHU	
6	PAOZZ	00779	60435-1	..TERMINAL,QUICK DISC	10
				UOC: LHU	
7	PAOZZ	00779	60253-2	..TERMINAL,QUICK DISC	10
				UOC: LHU	
8	PAOZZ	71468	BFR20-29S-1	..CONNECTOR,RECEPTACLE	2
				UOC: LHU	
9	PAOZZ	11139	5962-202-16141	..CONTACT,ELECTRICAL	6
				UOC: LHU	
10	PAOZZ	11139	DT06-4S	..CONNECTOR,PLUG	2
				UOC: LHU	
11	PAOZZ	11139	W4S	..LOCK,SECONDARY	2
				UOC: LHU	
12	PAOZZ	11139	114017	..PLUG,END,SEAL	2
				UOC: LHU	
13	PAOZZ	71468	BFR18-1S-1	..CONNECTOR,RECEPTACLE	1
				UOC: LHU	
14	PAOZZ	11139	DT04-4P-RT	.MODULE,DIODE	2
				UOC: LHU	
15	PFOZZ	45152	3135833	.BOX,SWITCH	1
				UOC: LHU	
16	XDOZZ	45152	3353066	.BRACKET,RELAY MOUNT	1
				UOC: LHU	
17	PAOZZ	96906	MS35338-44	.LOCKWASHER	2
				UOC: LHU	
18	PAOZZ	96906	MS51488-2	.SCREW,CAP,HEX HD	2
				UOC: LHU	
19	PFOZZ	78276	ALS7-1024-130	.INSERT,THREAD	2
				UOC: LHU	
20	PAOZZ	45152	3389198	BRACKET,RELAY SOCKET	1
				UOC:LHU	
21	PAOZZ	45152	2CH281	SCREW,PAN HEAD	1
				UOC:LHU	
22	PAOZZ	45152	1571850	NUT,SELF-LOCKING,HEX	1
				UOC:LHU	
23	PAOZZ	96906	MS35206-285	SCREW,PAN HEAD	4
				UOC: LHU	
24	PAOZZ	96906	MS27183-10	WASHER,FLAT	4
				UOC: LHU	
25	PFOZZ	45152	3217374	MTG PLATE,CONTROL BOX	1
				UOC: LHU	

SECTION II			TM 9-2320-304-14&P C01		
(1)	(2)	(3)	(4)	(5)	(6)
ITEM	SMR		PART		
NO	CODE	CAGEC	NUMBER	DESCRIPTION AND USABLE ON CODES(UOC)	QTY
26	PAOZZ	72962	21NE-040	NUT, SELF-LOCKING, HEX	4
				UOC: LHU	

END OF FIGURE

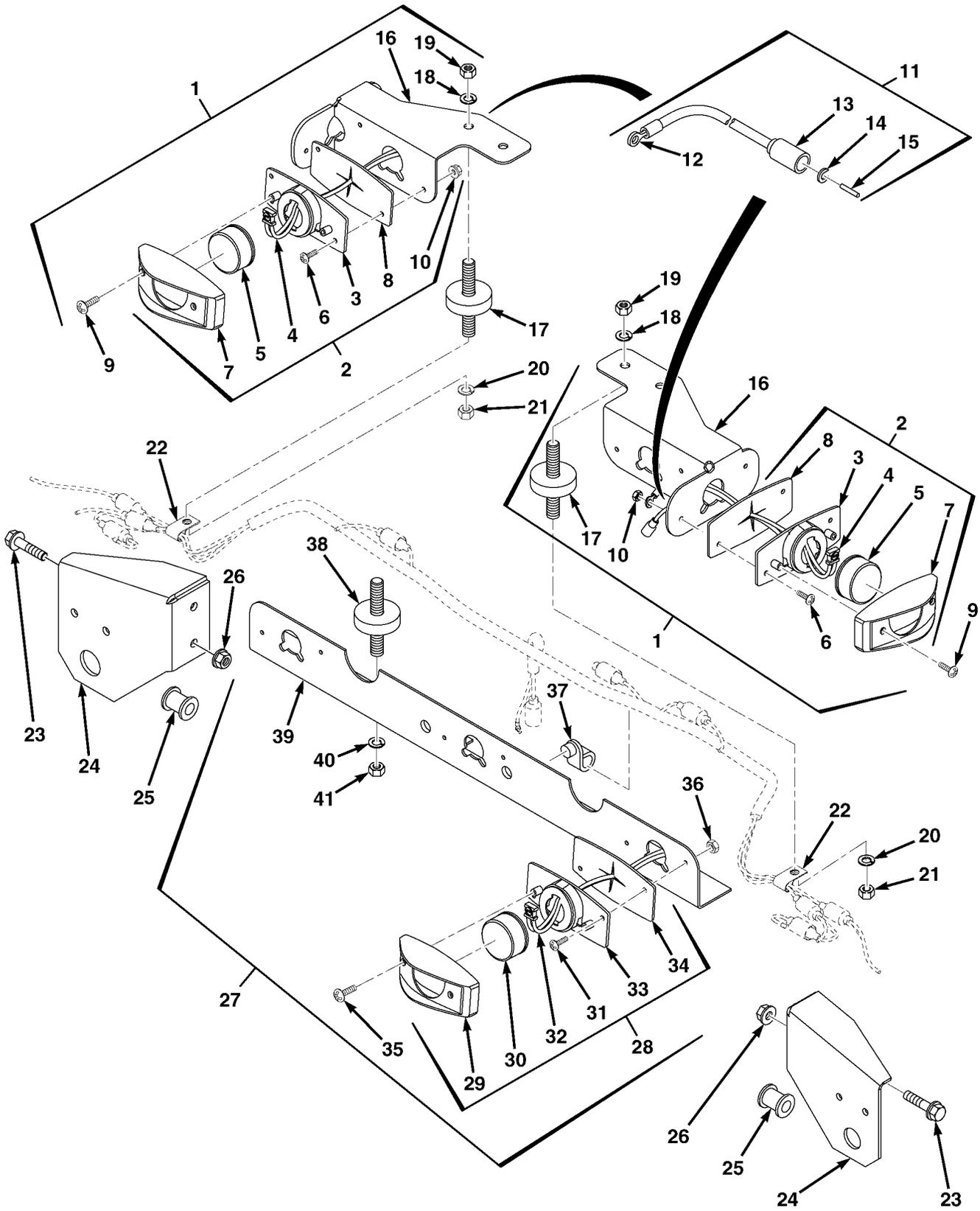

FIG. 51 LIGHT BAR ASSEMBLY

SECTION II

TM 9-2320-304-14&P C01

(1) ITEM NO	(2) SMR CODE	(3) CAGEC CAGEC	(4) PART NUMBER	(5) DESCRIPTION AND USABLE ON CODES(UOC)	(6) QTY
GROUP 3307 SPECIAL PURPOSE KIT					
FIG. 51 LIGHT BAR ASSEMBLY					
1	PAOOO	45152	3349084	LIGHT ASSY,CLEARANCE RH	1
				UOC: LHU	
1	PAOOO	45152	3349085	LIGHT ASSY, CLEARANCE LH	1
				UOC: LHU	
2	PAOZZ	13548	07195	.LIGHT,MARKER,CLEARANCE	2
				UOC: LHU	
3	XAOZZ	13548	07197	..BASE,MOUNTING	1
				UOC: LHU	
4	PFOZZ	12548	94626	..PIGTAIL	1
				UOC: LHU	
5	PAOZZ	13548	30250Y	..DIODE,LIGHT EMITTING	1
				UOC: LHU	
6	PAOZZ	96906	MS51958-64	..SCREW,MACHINE	2
				UOC: LHU	
7	XAOZZ	13548	07198	..BRACKET,OUTER	1
				UOC: LHU	
8	PAOZZ	13548	5370	..GASKET,MOUNTING	1
				UOC: LHU	
9	PAOZZ	45152	59031AX	..SCREW,MACHINE	4
				UOC: LHU	
10	PAOZZ	45152	1571850	..NUT,SELF-LOCKING,WASHER	4
				UOC: LHU	
11	PAOOO	45152	3349083	..WIRE ASSY	1
				UOC: LHU	
12	PAOZZ	96906	MS25036-112	..LUG,TERMINAL	1
				UOC: LHU	
13	PAOZZ	19207	8724495	..SHELL	1
				UOC: LHU	
14	PAOZZ	19207	8338567	..WASHER,SLOTTED	1
				UOC: LHU	
15	PAOZZ	96906	MS27148-2	..TERMINAL	1
				UOC: LHU	
16	XAOZZ	45152	2270080W	..BRACKET,LIGHT RH	1
				UOC: LHU	
16	XAOZZ	45152	2270090W	..BRACKET,LIGHT LH	1
				UOC: LHU	
17	PFOZZ	42366	16282B-35005	..MOUNT,SHEAR	2
				UOC: LHU	
18	PAOZZ	45152	351AX	..WASHER,LOCK	2
				UOC: LHU	
19	PAOZZ	45152	434-A	..NUT,PLAIN	2
				UOC: LHU	
20	PAOZZ	45152	351AX	WASHER,LOCK	6
				UOC: LHU	
21	PAOZZ	45152	434-A	NUT,HEX	6
				UOC: LHU	
22	PAOZZ	75272	COV0713	CLIP,CUSHIONED	2
				UOC: LHU	
23	PAOZZ	52167	WC0414PB	BOLT,MACHINE	4
				UOC: LHU	

SECTION II

TM 9-2320-304-14&P C01

(1) ITEM NO	(2) SMR CODE	(3) CAGEC	(4) PART NUMBER	(5) DESCRIPTION AND USABLE ON CODES(UOC)	(6) QTY
24	PFOZZ	45152	3150265	BRACKET,RH LIGHT MTG UOC: LHU	1
24	PFOZZ	45152	3149277	BRACKET,LH LIGHT MTG UOC: LHU	1
25	PAOZZ	70485	2406	GROMMET UOC: LHU	2
26	PAOZZ	82458	T892R	NUT,SELF-LOCKING,EW,HEX UOC: LHU	4
27	PAOOO	45152	3348988	LIGHT BAR ASSY UOC: LHU	1
28	PAOOO	13548	07195	.LIGHT,MARKER CLEARA UOC: LHU	3
29	XAOZZ	13548	07198	..BRACKET,OUTER UOC: LHU	1
30	PAOZZ	13548	30250Y	..DIODE,LIGHT EMITTING UOC: LHU	1
31	PAOZZ	96906	MS51958-64	..SCREW,MACHINE UOC: LHU	2
32	PAOZZ	13548	94626	..LEAD ASSY, ELECTRICAL UOC: LHU	1
33	XAOZZ	13548	07197	..BASE,MOUNTING UOC: LHU	1
34	PAOZZ	13548	5370	..GASKET,MOUNTING UOC: LHU	1
35	PAOZZ	45152	59031AX	.SCREW,MACHINE UOC: LHU	6
36	PAOZZ	45152	1571850	.NUT,SELF-LOCKING,WASHER UOC: LHU	6
37	PAOZZ	83014	H360K2598	.CLAMP,LOOP UOC: LHU	2
38	PFOZZ	43266	16282B-35005	.MOUNTING,SHEAR UOC: LHU	2
39	XAOZZ	45152	3217377	.BAR,LIGHT UOC: LHU	1
40	PAOZZ	45152	351AX	.WASHER,LOCK UOC: LHU	2
41	PAOZZ	45152	434-A	.NUT,HEX UOC: LHU	2

END OF FIGURE

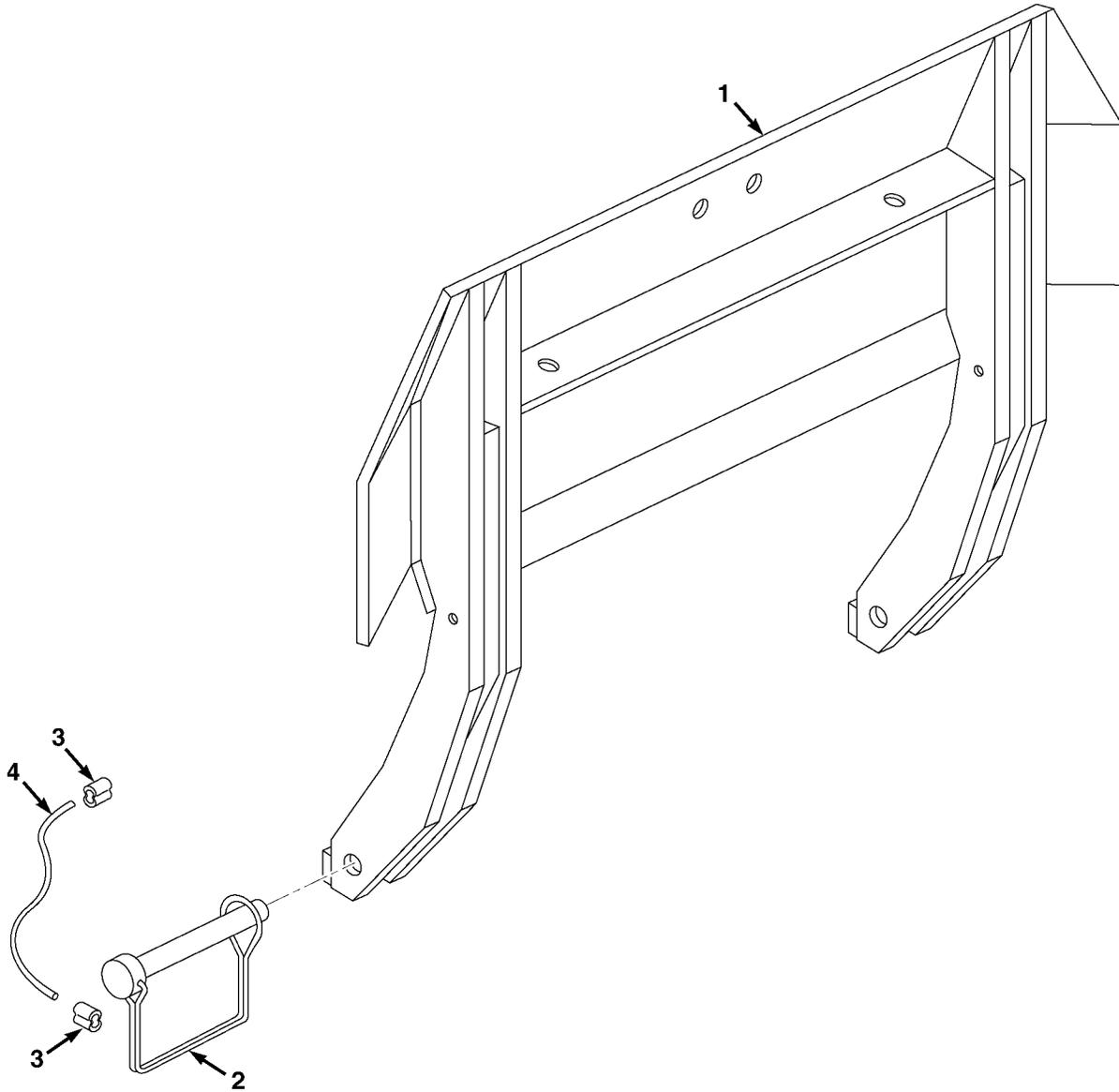

FIG. 52 CONTAINER GUIDE

SECTION II

TM 9-2320-304-14&P C01

(1) ITEM NO	(2) SMR CODE	(3) CAGEC CAGEC	(4) PART NUMBER	(5) DESCRIPTION AND USABLE ON CODES(UC)	(6) QTY
GROUP 3307 SPECIAL PURPOSE KIT					
FIG. 52 CONTAINER GUIDE					
1	PBOZZ	45152	3188476	GUIDE, POSITIONING	2
				UOC: LHU	
2	PAOZZ	96652	28-06	PIN, TOGGLE HEADED	4
				UOC: LHU	
3	PAOZZ	96906	MS51844-43	SWAGE SLEEVE, WIRE ROPE	8
				UOC: LHU	
4	MOOZZ	45152	1533100-32	ROPE, WIRE MAKE FROM WIRE	4
				879447-01 (18894)	
				32 IN LG.	
				UOC: LHU	

END OF FIGURE

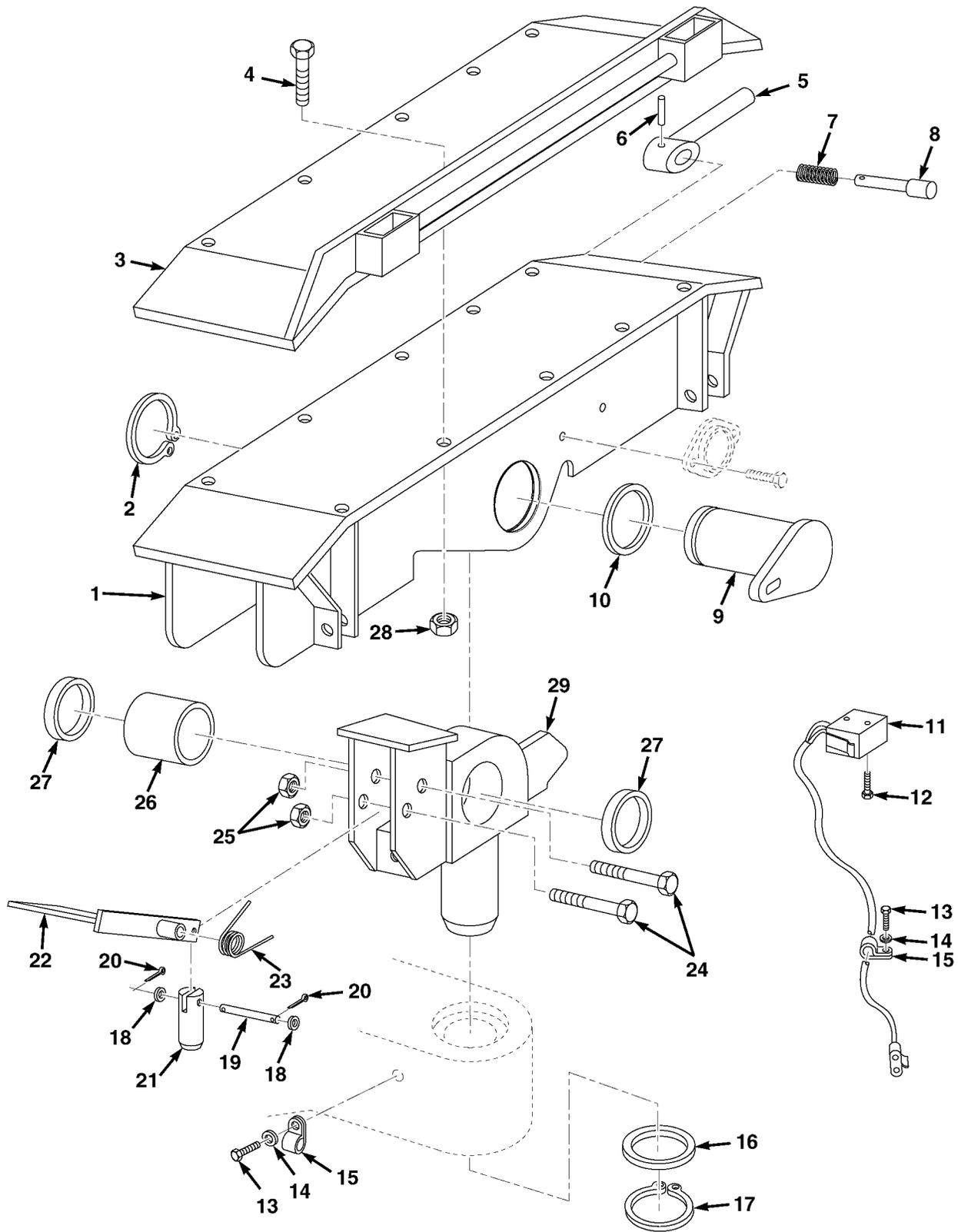

FIG. 53 SLIDER ASSEMBLY

SECTION II

TM 9-2320-304-14&P C01

(1) ITEM NO	(2) SMR CODE	(3) CAGEC	(4) PART NUMBER	(5) DESCRIPTION AND USABLE ON CODES(UOC)	(6) QTY
GROUP 3307 SPECIAL PURPOSE KIT FIG. 53 SLIDER ASSEMBLY					
1	PBOZZ	45152	3123917	SLIDER,RH UOC: LHU	1
1	PBOZZ	45152	3123918	SLIDER,LH UOC: LHU	1
2	PAOZZ	79136	5100-315	RING,RETAINING UOC: LHU	2
3	PFOZZ	45152	3117428	WEAR PLATE,RH UOC: LHU	1
3	PFOZZ	45152	3117429	WEAR PLATE,LH UOC: LHU	1
4	PFOZZ	45152	2196790	SCREW,CAP,SKT HEAD UOC: LHU	20
5	PBOZZ	45152	3129006	HANDLE UOC: LHU	2
6	PAOZZ	45152	1840070	PIN,SPRING UOC: LHU	2
7	PAOZZ	45152	3126499	SPRING,COMPRESSION UOC: LHU	2
8	PBOZZ	45152	3128999	PIN,LOCK UOC: LHU	2
9	PFOZZ	45152	1860310 W	PIN,PIVOT MID FRAME UOC: LHU	2
10	PFOZZ	45152	1862820	SHIM UOC: LHU	2
11	PAOZZ	81901	E1117-525	SWITCH,LIMIT REAR UOC: LHU	2
12	PAOZZ	45152	2CH281	SCREW,MACHINE UOC: LHU	4
13	PAOZZ	80204	B1821BH025C075N	SCREW,CAP,HEX UOC: LHU	6
14	PAOZZ	96906	MS27183-10	WASHER,FLAT UOC: LHU	6
15	PAOZZ	75272	COV050971	CLAMP,LOOP UOC: LHU	6
16	PFOZZ	45152	2253880	SHIM UOC: LHU	2
17	PAOZZ	96906	MS16624-250	RING,RETAINING UOC: LHU	2
18	PAOZZ	45152	362AX	WASHER,FLAT UOC: LHU	4
19	PBOZZ	45152	3117567	PIN,PIVOT LOCK UOC: LHU	2
20	PAOZZ	45152	1749HX	PIN,COTTER UOC: LHU	4
21	PBOZZ	45152	3117504	PIN,PIVOT LOCK UOC: LHU	2
22	PFOZZ	45152	3117505	ARM,PIVOT LOCK UOC: LHU	2

SECTION II

TM 9-2320-304-14&P C01

(1) ITEM NO	(2) SMR CODE	(3) CAGEC	(4) PART NUMBER	(5) DESCRIPTION AND USABLE ON CODES(UOC)	(6) QTY
23	PFOZZ	45152	3117507	SPRING,TORSION UOC: LHU	2
24	PAOZZ	45152	1754310	SCREW,CAP,HEX HD UOC: LHU	4
25	PAOZZ	82458	T892R	NUT,SELF-LOCKING HEX UOC: LHU	4
26	PFFZZ	2K272	GLY.PG 808560A	BUSHING UOC: LHU	2
27	PAOZZ	01212	80X100X10	SEAL,OIL UOC: LHU	4
28	PAOZZ	45152	115307A	NUT,HEX UOC: LHU	20
29	PAOZZ	45152	3121863	PIVOT,SLIDER UOC: LHU	2

END OF FIGURE

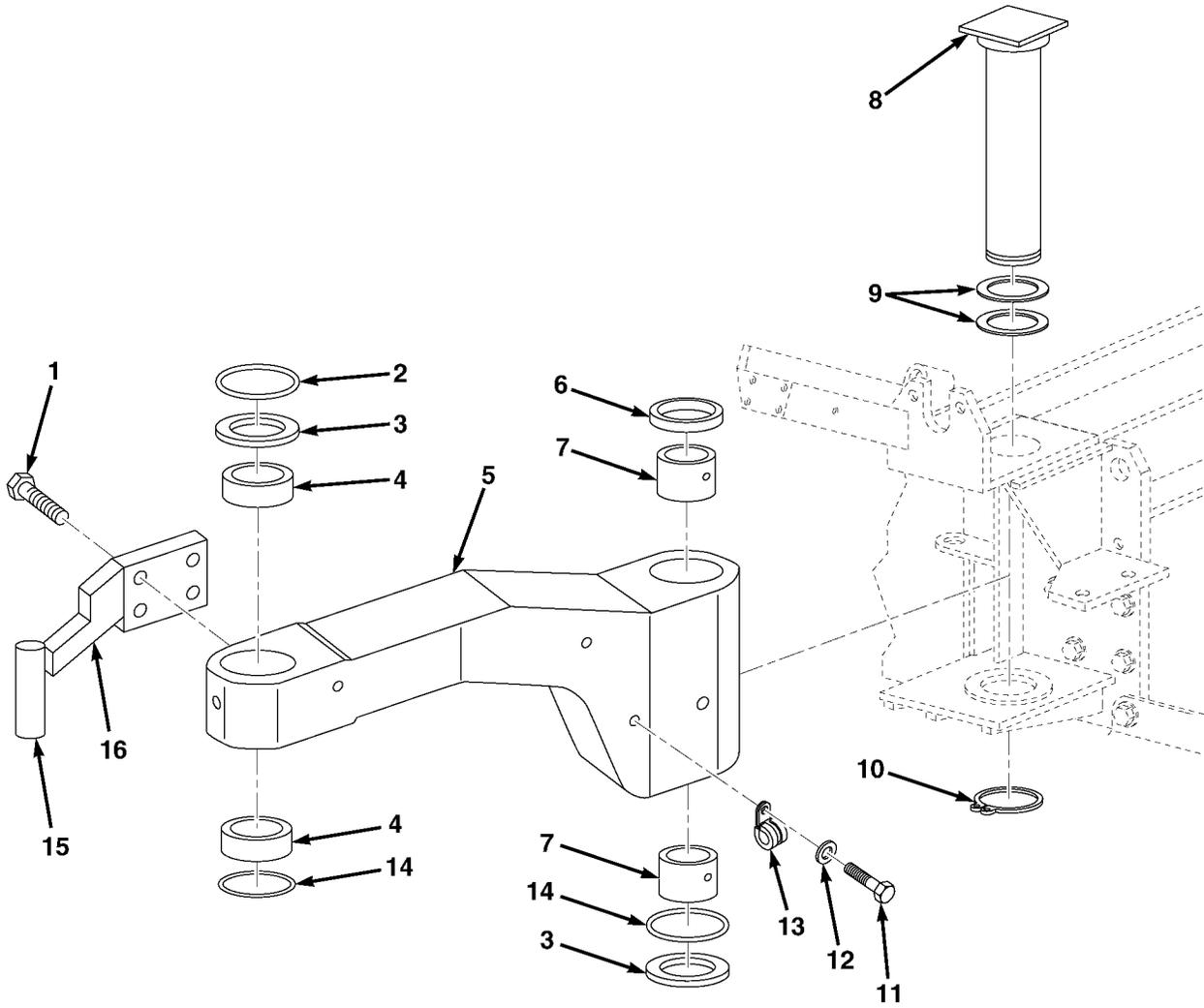

FIG. 54 SLIDER ARM

SECTION II

TM 9-2320-304-14&P C01

(1) ITEM NO	(2) SMR CODE	(3) CAGEC	(4) PART NUMBER	(5) DESCRIPTION AND USABLE ON CODES(UOC)	(6) QTY
GROUP 3307 SPECIAL PURPOSE KIT					
FIG. 54 SLIDER ARM					
1	PAOZZ	45152	115306A	SCREW,CAP,HEX HD	8
				UOC: LHU	
2	PAOZZ	01212	800850	SEAL,V-LIP	2
				UOC: LHU	
3	PFOZZ	45152	2254220	WASHER,THRUST	4
				UOC: LHU	
4	PAFZZ	45152	2258840	BUSHING	4
				UOC: LHU	
5	PBFZZ	45152	3121846	ARM,SLIDER RH	1
				UOC: LHU	
5	PBFZZ	45152	3121847	ARM,SLIDER LH	1
				UOC: LHU	
6	PAOZZ	01212	801000	SEAL,V-LIP	2
				UOC: LHU	
7	PAFZZ	2K272	GLY.PG657070A	BUSHING	4
				UOC: LHU	
8	PBOZZ	45152	3119744	PIN,PIVOT	2
				UOC: LHU	
9	PFOZZ	45152	3124572	SHIM	4
				UOC: LHU	
10	PAOZZ	96906	MS16624-250	RING,RETAINING	2
				UOC: LHU	
11	PAOZZ	80204	B1821BH025C075N	SCREW,CAP,HEX HD	6
				UOC: LHU	
12	PAOZZ	96906	MS27183-10	WASHER,FLAT	6
				UOC: LHU	
13	PAOZZ	75272	COVO50971	CLAMP,LOOP	1
				UOC: LHU	
14	PAOZZ	70485	OR150	SEAL,O-RING	4
				UOC: LHU	
15	PFOZZ	45152	3218659	LOCK,SLIDER PIVOT LH	1
				UOC: LHU	
15	PFOZZ	45152	3218660	LOCK,SLIDER PIVOT RH	1
				UOC: LHU	
16	XDOZZ	45152	3117546	HANDLE,ARM PIVOT LH	1
				UOC: LHU	
16	XDOZZ	45152	3127724	HANDLE,ARM PIVOT RH	1
				UOC: LHU	

END OF FIGURE

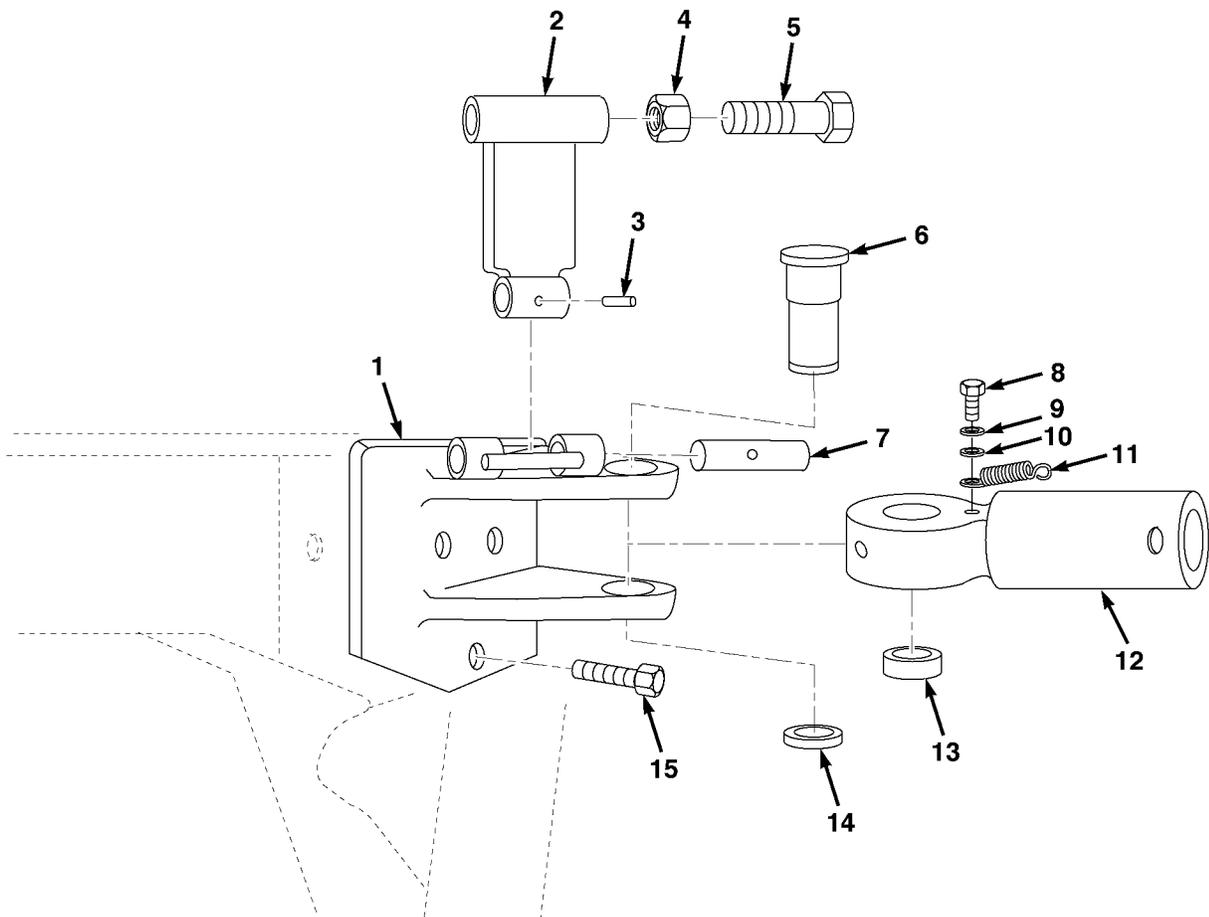

FIG. 55 SHORT STRUT & FLIP LOCK PIN

SECTION II

TM 9-2320-304-14&P C01

(1) ITEM NO	(2) SMR CODE	(3) CAGEC CAGEC	(4) PART NUMBER	(5) DESCRIPTION AND USABLE ON CODES(UOC)	(6) QTY
GROUP 3307 SPECIAL PURPOSE KITS					
FIG. 55 SHORT STRUT & FLIP LOCK PIN					
1	XDOZZ	45152	3126527	BRACKET,PIN RH	1
				UOC: LHU	
1	XDOZZ	45152	3126528	BRACKET,PIN LH	1
				UOC: LHU	
2	PAOZZ	45152	3127712	LOCK,FLIP	2
				UOC: LHU	
3	PAOZZ	45152	1840070	PIN,SPRING	2
				UOC: LHU	
4	PAOZZ	45152	1833HX1	NUT,PLAIN,HEX	2
				UOC: LHU	
5	PAOZZ	45152	1336700	SCREW,CAP,HEX HD	2
				UOC: LHU	
6	PAOZZ	45152	3227252	PIN,STRUT	1
				UOC: LHU	
7	PAOZZ	45152	3127723	PIN,FLIP LOCK	2
				UOC: LHU	
8	PAOZZ	45152	66420AX	SCREW,CAP,HEX HD	2
				UOC: LHU	
9	PAOZZ	96906	MS27183-10	WASHER,FLAT	2
				UOC: LHU	
10	PAOZZ	45152	362AX	WASHER,FLAT	2
				UOC: LHU	
11	PAOZZ	45152	3197833	SPRING	2
				UOC: LHU	
12	PBOZZ	45152	3121882	STRUT,SHORT	2
				UOC: LHU	
13	PAOZZ	45152	3127711	RING,ADJUSTING	1
				UOC: LHU	
14	PAOZZ	45152	2176780	RING,ADJUSTING	1
				UOC: LHU	
15	PAOZZ	45152	115304A	BOLT,MACHINE	8
				UOC: LHU	

END OF FIGURE

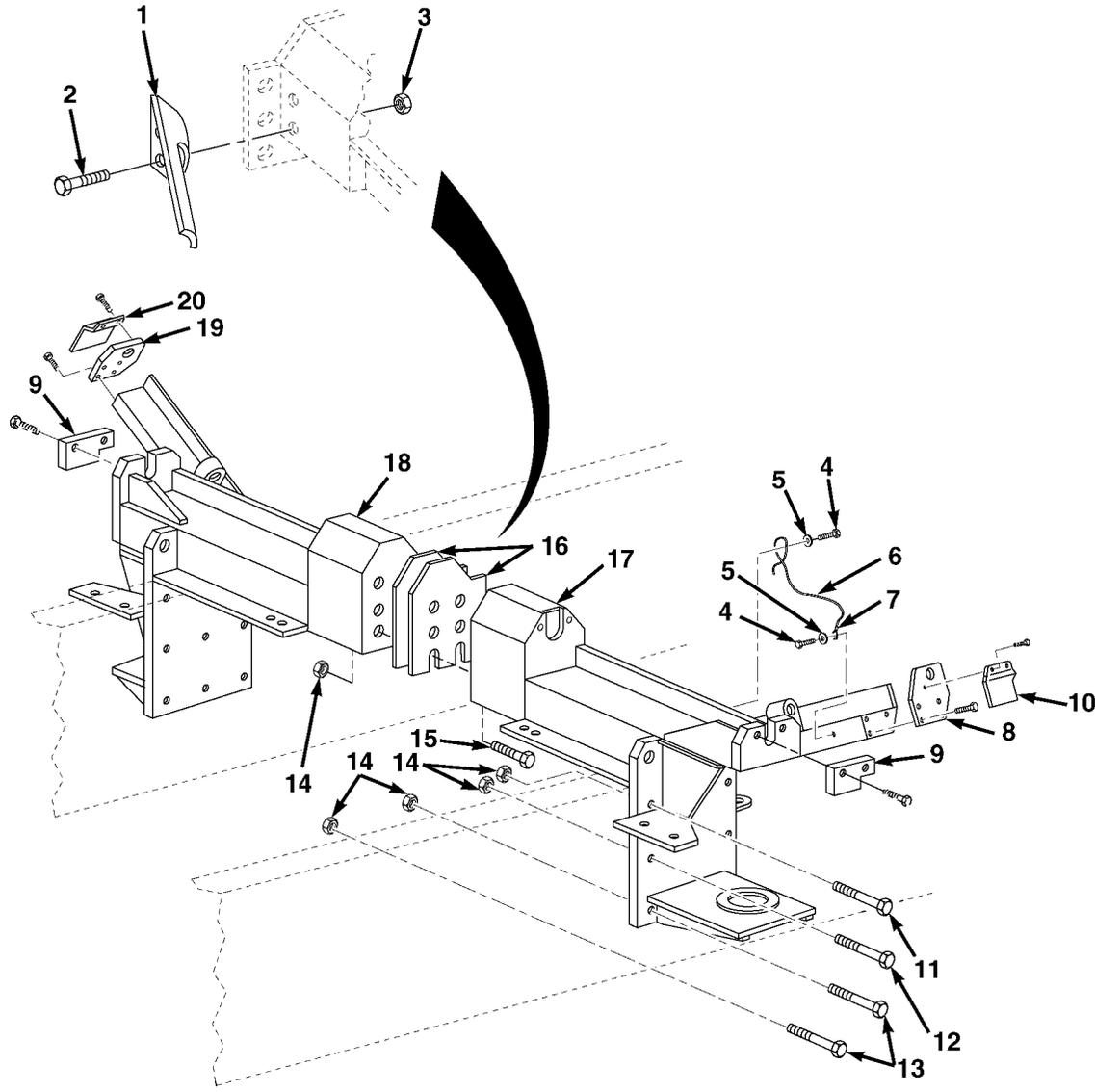

FIG. 56 REAR CONTAINER SUPPORT

SECTION II

TM 9-2320-304-14&P C01

(1) ITEM NO	(2) SMR CODE	(3) CAGEC CAGEC	(4) PART NUMBER	(5) DESCRIPTION AND USABLE ON CODES(UOC)	(6) QTY
GROUP 3307 SPECIAL PURPOSE KIT FIG. 56 REAR CONTAINER SUPPORT					
1	PFOZZ	45152	3192798	PLATE,REAR BRKT RH UOC: LHU	1
1	PFOZZ	45152	3192799	PLATE,REAR BRKT LH UOC: LHU	1
2	PAOZZ	45152	115293A	SCREW,CAP,HEX HD UOC: LHU	4
3	PAOZZ	45152	110310A	NUT,SELF-LOCKING,HEX UOC: LHU	4
4	PAOZZ	93907	234 86500-382	SCREW,CAP,HEX HD UOC: LHU	4
5	PAOZZ	45152	2302HX	WASHER,FLAT UOC: LHU	4
6	MOOZZ	45152	1533100-40	ROPE,WIRE MAKE FROM WIRE 879447-01 (18894), 40 IN. LG. UOC: LHU	1
7	PAOZZ	96906	MS51844-43	SWAGE,SLEEVE UOC: LHU	4
8	XDOZZ	45152	2255150	PLATE,END RH UOC: LHU	1
9	PFOZZ	45152	3117420	PLATE,LOCK UOC: LHU	2
10	PFOZZ	45152	3138310	BRACKET,RH UOC: LHU	1
11	PAOZZ	45152	1336700	SCREW,CAP,HEX HD UOC: LHU	14
12	PAOZZ	45152	1317120	SCREW,CAP,HEX HD UOC: LHU	4
13	PAOZZ	45152	111319A	SCREW,CAP,HEX HD UOC: LHU	6
14	PAOZZ	45152	110312A	NUT,SELF-LOCKING,HEX UOC: LHU	30
15	PAOZZ	45152	1337720	SCREW,CAP,HEX HD UOC: LHU	6
16	PFOZZ	45152	3124573	SHIM,BRACKET UOC: LHU	2
17	PFOZZ	45152	3335177	BRACKET,REAR RH UOC: LHU	1
18	PFOZZ	45152	3335176	BRACKET,REAR LH UOC: LHU	1
19	XDOZZ	45152	2255160	PLATE,END LH UOC: LHU	1
20	PFOZZ	45152	3124574	BRACKET,LH UOC: LHU	1

END OF FIGURE

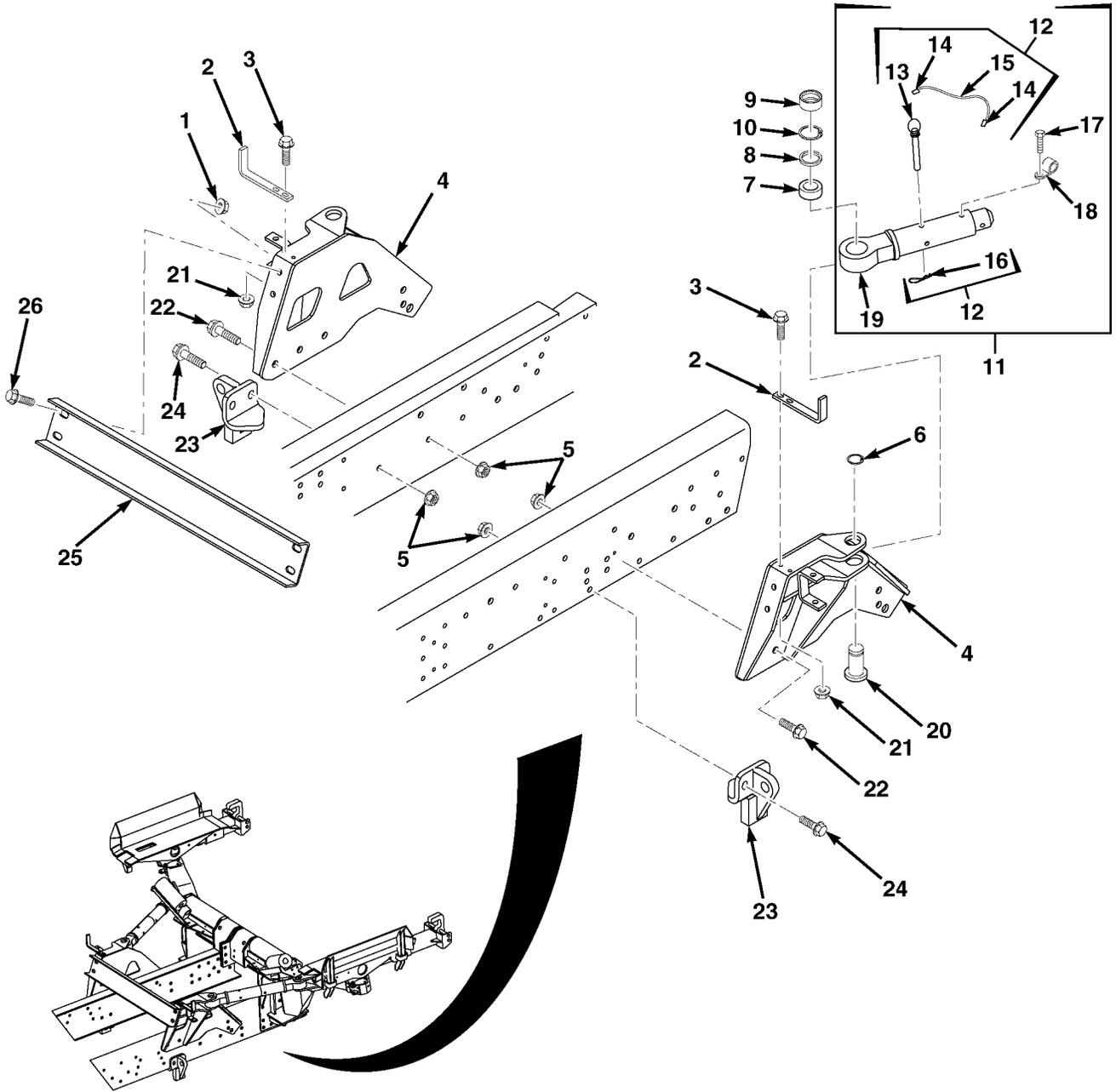

FIG. 57 REAR CONTAINER SUPPORT CROSS BRACE & LONG STRUT

SECTION II

TM 9-2320-304-14&P C01

(1) ITEM NO	(2) SMR CODE	(3) CAGEC CAGEC	(4) PART NUMBER	(5) DESCRIPTION AND USABLE ON CODES(UOC)	(6) QTY
GROUP 3307 SPECIAL PURPOSE KIT					
FIG. 57 REAR CONTAINER SUPPORT CROSS BRACE					
1	PAOZZ	45152	110311A	NUT, SELF-LOCKING, EW, HEX UOC: LHU	4
2	PFOZZ	45152	3217375	ANGLE, SLIDER STOWAGE UOC: LHU	2
3	PAOZZ	45152	120699A	SCREW, CAP, EW, HEX UOC: LHU	4
4	PFOZZ	45152	3353148	BRACKET, LH STRUT SUPPORT UOC: LHU	1
4	PFOZZ	45152	3353147	BRACKET, RH STRUT SUPPORT UOC: LHU	1
5	PAOZZ	45152	110312A	NUT, SELF-LOCKING, EW, HEX UOC: LHU	1
6	PAOZZ	96906	MS16624-4175	RING, RETAINING UOC: LHU	2
7	PFOZZ	2K272	GE45E8-2RS	BEARING, SPHERICAL UOC: LHU	4
8	PFOZZ	45152	1862320	RING, SUPPORT UOC: LHU	4
9	PFOZZ	45152	3127711	RING, ADJUSTING UOC: LHU	4
10	PAOZZ	79136	N5000-268	RING, RETAINING UOC: LHU	4
11	PBOOO	45152	3121879	STRUT, LONG UOC: LHU	2
12	PFOOO	45152	2173040	.PIN ASSEMBLY UOC: LHU	1
13	XAOZZ	45152	2173040XA	..PIN UOC: LHU	1
14	PAOZZ	37581	NICROPRESS18-1C	..SWAGING SLEEVE, WIRE UOC: LHU	2
15	MOOZZ	45152	1533100-10	..ROPE, WIRE MAKE FROM WIRE P/N 879447-01 (18894) 10 IN. LG. UOC: LHU	1
16	PAOZZ	45152	EE40567	..PIN, LOCK UOC: LHU	1
17	PAOZZ	45152	1606140	.SCREW, CAP, HEX HD UOC: LHU	1
18	PAOZZ	75272	COV050971	.CLAMP, LOOP UOC: LHU	1
19	PFOZZ	45152	3121881	.STRUT, SHAFT UOC: LHU	1
20	PAOZZ	45152	3227252	PIN, STRUT UOC: LHU	4
21	PAOZZ	45152	115307A	NUT, SELF-LOCKING UOC: LHU	4
22	PAOZZ	45152	1336700	SCREW, CAP, EW, HEX UOC: LHU	9
23	PFOZZ	45152	3353065	AXLES, STOP UOC: LHU	2

SECTION II			TM 9-2320-304-14&P C01		
(1)	(2)	(3)	(4)	(5)	(6)
ITEM	SMR		PART		
NO	CODE	CAGEC	NUMBER	DESCRIPTION AND USABLE ON CODES(UOC)	QTY
24	PAOZZ	45152	111320A	SCREW,CAP,EW,HEX	5
				UOC: LHU	
25	PFOZZ	45152	3145738	BRACE,CROSS,SUPPORT	1
				UOC: LHU	
26	PAOZZ	45152	WE0816TB	SCREW,CAP,EW,HEX	4
				UOC: LHU	

END OF FIGURE

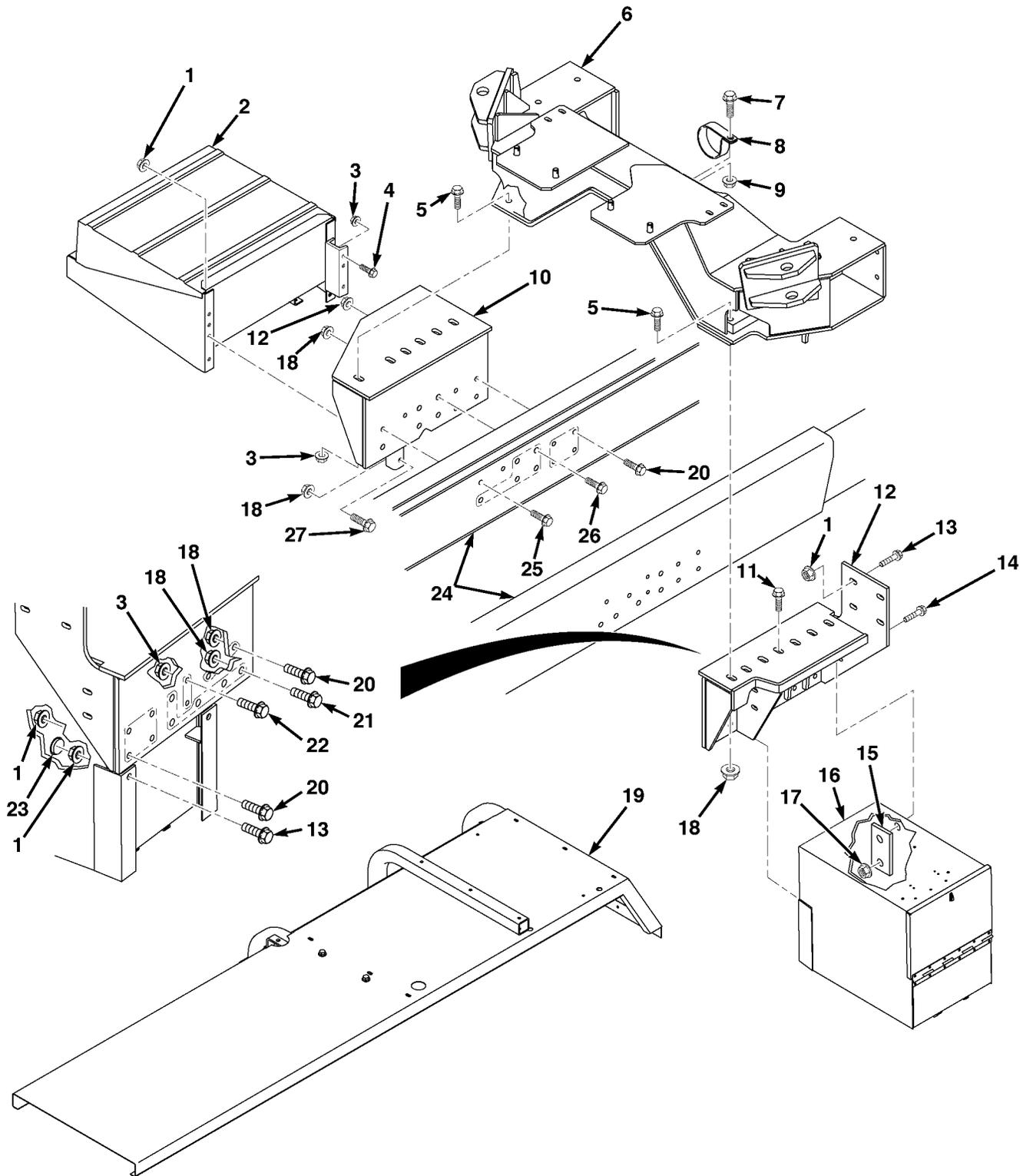

FIG. 58 FRONT CONTAINER SUPPORT (SHEET 1 OF 2)

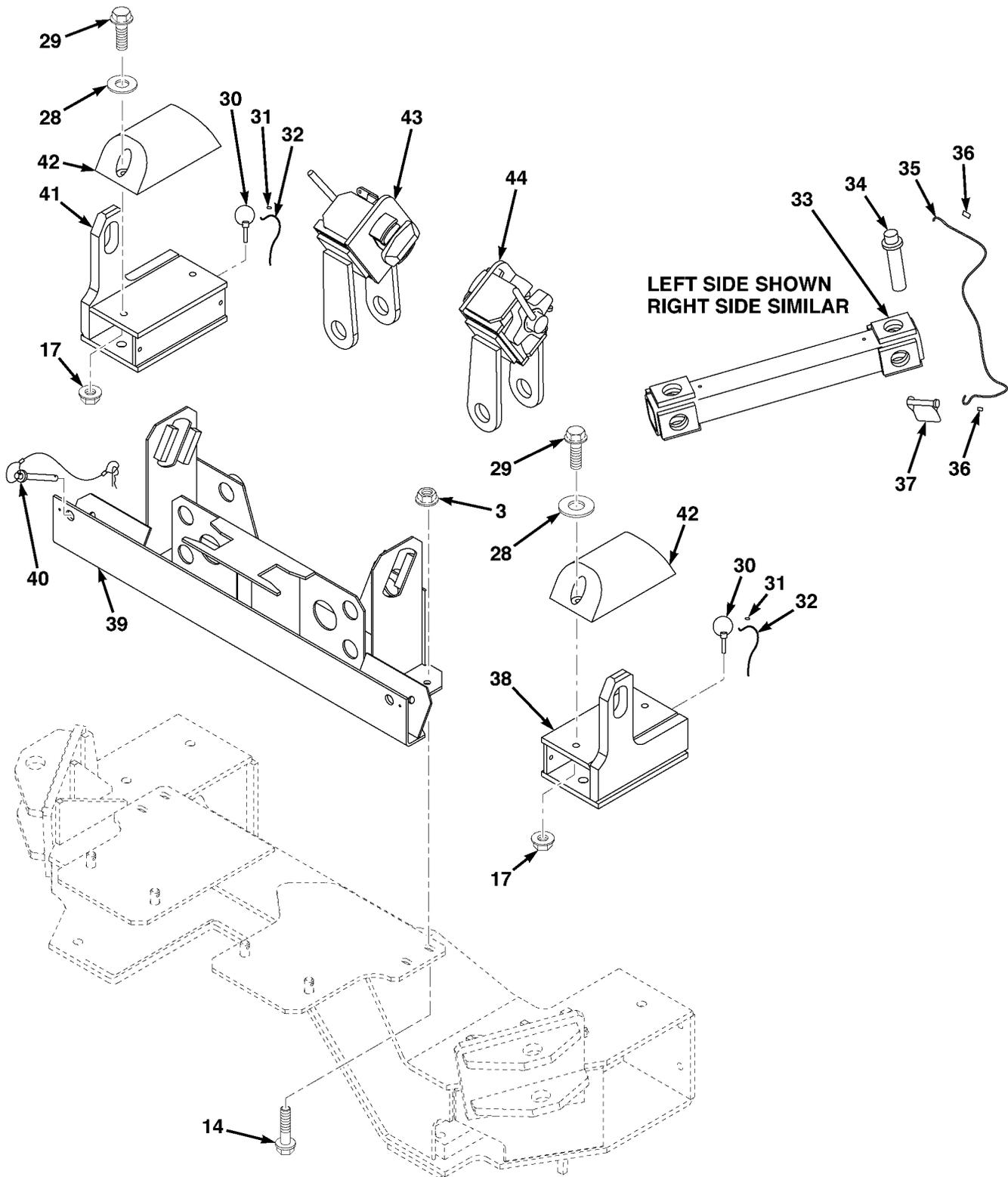

FIG. 58 FRONT CONTAINER SUPPORT (SHEET 2 OF 2)

SECTION II

TM 9-2320-304-14&P C01

(1) ITEM NO	(2) SMR CODE	(3) CAGEC CAGEC	(4) PART NUMBER	(5) DESCRIPTION AND USABLE ON CODES(UOC)	(6) QTY
GROUP 3307 SPECIAL PURPOSE KIT					
FIG. 58 FRONT CONTAINER SUPPORT					
1	PAOZZ	45152	110311A	NUT, SELF-LOCKING, FLANGED	17
				UOC: LHU	
2	PFOZZ	45152	3359616	BOX, BATTERY	1
				UOC: LHU	
3	PAOZZ	45152	110310A	NUT, SELF-LOCKING, FLANGED	10
				UOC: LHU	
4	PAOZZ	45152	1556620	SCREW, CAP, FLANGED	3
				UOC: LHU	
5	PAOZZ	45152	1324980	SCREW, CAP, FLANGED	6
				UOC: LHU	
6	PFOZZ	45152	3346716	CROSSMEMBER, FRONT CHU SUPPORT	1
				UOC: LHU	
7	PAOZZ	45152	1754210	SCREW, CAP, FLANGED	1
				UOC: LHU	
8	PAOZZ	84971	TA720S24	LOOP, CLAMP	1
				UOC: LHU	
9	PAOZZ	45152	1333510	NUT, SELF-LOCKING, FLANGED	1
				UOC: LHU	
10	PFOZZ	45152	3344561	CROSSMEMBER SUPPORT, FRONT	1
				UOC: LHU	
11	PAOZZ	45152	1317120	SCREW, CAP, FLANGED	7
				UOC: LHU	
12	PFOZZ	45152	3344562	CROSSMEMBER SUPPORT, FRONT	1
				UOC: LHU	
13	PAOZZ	52167	WE0820TB	SCREW, CAP, FLANGED	6
				UOC: LHU	
14	PAOZZ	45152	115293A	SCREW, CAP, FLANGED	8
				UOC: LHU	
15	PFOZZ	52167	3357391	PLATE, STOWAGE BOX MTG	2
				UOC: LHU	
16	PFOZZ	45152	3357080	BOX, STOWAGE	1
				UOC: LHU	
17	PAOZZ	45152	1598030	NUT, SELF-LOCKING, FLANGED	8
				UOC: LHU	
18	PAOZZ	45152	110312A	NUT, SELF-LOCKING, FLANGED	23
				UOC: LHU	
19	PFOZZ	45152	3217276	FENDER	1
				UOC: LHU	
20	PAOZZ	45152	120622A	SCREW, CAP, FLANGED	10
				UOC: LHU	
21	PAOZZ	45152	1337720	SCREW, CAP, FLANGED	10
				UOC: LHU	
22	PAOZZ	45152	111315A	SCREW, CAP, FLANGED	5
				UOC: LHU	
23	PAOZZ	28520	DP-1750-2773	PLUG, HOLE	2
				UOC: LHU	
24	PFOZZ	45152	3355525	FRAME	1
				UOC: LHU	
25	PAOZZ	45152	1337720	SCREW, CAP, FLANGED	1
				UOC: LHU	

SECTION II

TM 9-2320-304-14&P C01

(1) ITEM NO	(2) SMR CODE	(3) CAGEC	(4) PART NUMBER	(5) DESCRIPTION AND USABLE ON CODES(UOC)	(6) QTY
26	PAOZZ	45152	111317A	SCREW,CAP,FLANGED UOC: LHU	1
27	PAOZZ	45152	1781440	SCREW,CAP,FLANGED UOC: LHU	1
28	PAOZZ	45152	720HX	WASHER,FLAT UOC: LHU	4
29	PAOZZ	45152	1772HX2	SCREW,CAP,HEX UOC: LHU	4
30	PAOZZ	96652	63-02	PIN,QUICK RELEASE UOC: LHU	4
31	PAOZZ	06721	1737095	SLEEVE,CRIMPING UOC: LHU	4
32	MOOZZ	45152	2282360-28	ROPE,WIRE MAKE FROM WIRE 2282360 (45152), 28 IN. LG UOC: LHU	1
33	PFOZZ	45152	3345899	STRUT,RAIL,TRANSPORT UOC: LHU	2
34	PFOZZ	45152	3124495	PIN UOC: LHU	4
35	MOOZZ	45152	1533100-52	ROPE,WIRE MAKE FROM WIRE 879447-01 (18894), 52 IN. LG UOC: LHU	2
36	PAOZZ	45152	MS51844-43	SLEEVE,SWAGING UOC: LHU	8
37	PAOZZ	46652	28-07	PIN,SNAPPER UOC: LHU	4
38	PFOZZ	45152	3346009	BRACKET,FLA SUPPORT LH UOC: LHU	1
39	PBOZZ	45152	3347761	TRAY,STOWAGE UOC: LHU	1
40	PAOZZ	45152	2173040	PIN, 1/2 SNAPPER UOC: LHU	2
41	PFOZZ	45152	3346010	BRACKET,FLA SUPPORT RH UOC: LHU	1
42	PAOZZ	45152	3234880	BUMPER,RUBBER UOC: LHU	2
43	PAOZZ	45152	3143298	LOCK,ISO UOC: LHU	1
44	PAOZZ	45152	3143309	LOCK,ISO UOC: LHU	1

END OF FIGURE

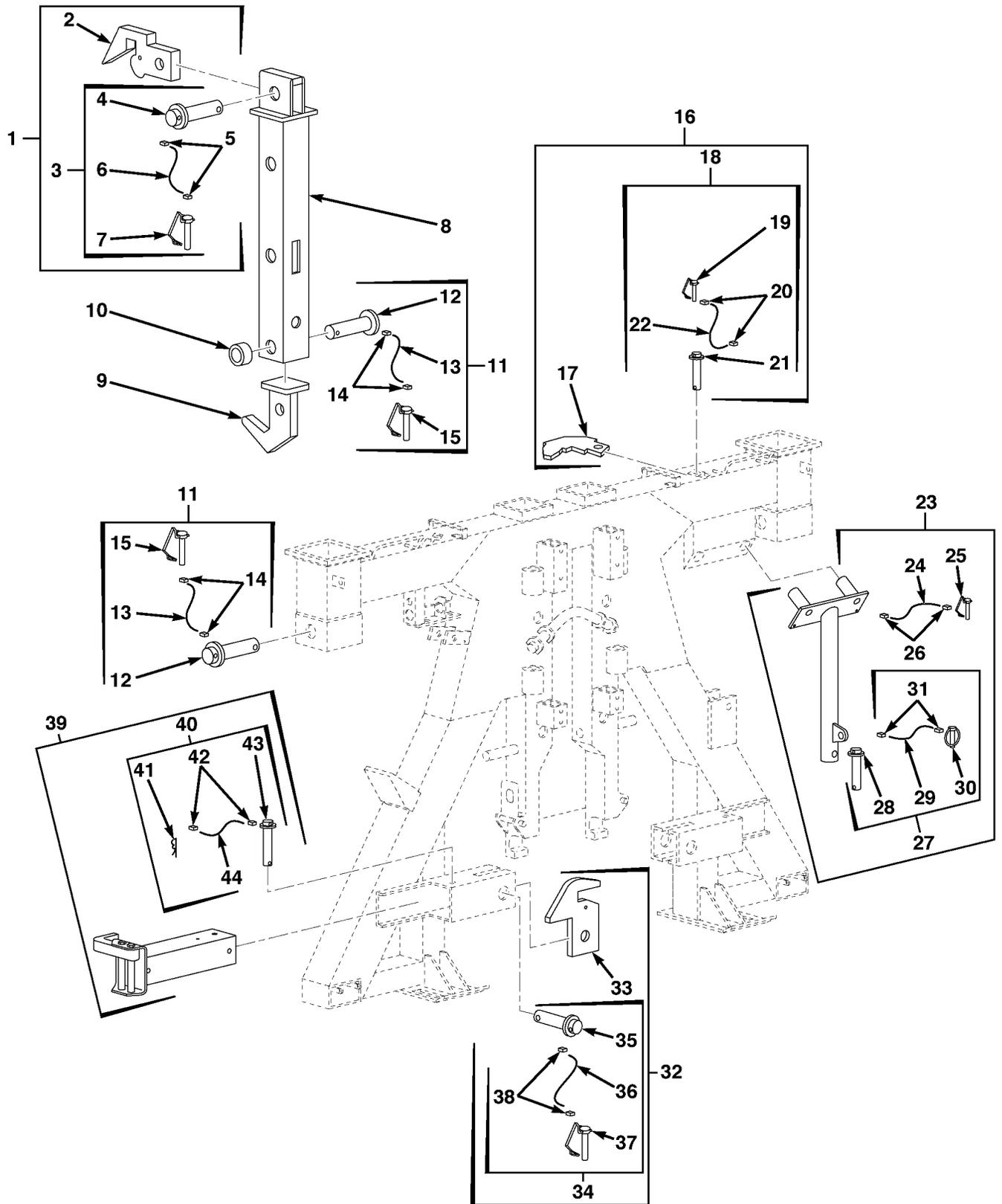

FIG. 59 FRONT LIFTING ADAPTER (SHEET 1 OF 2)

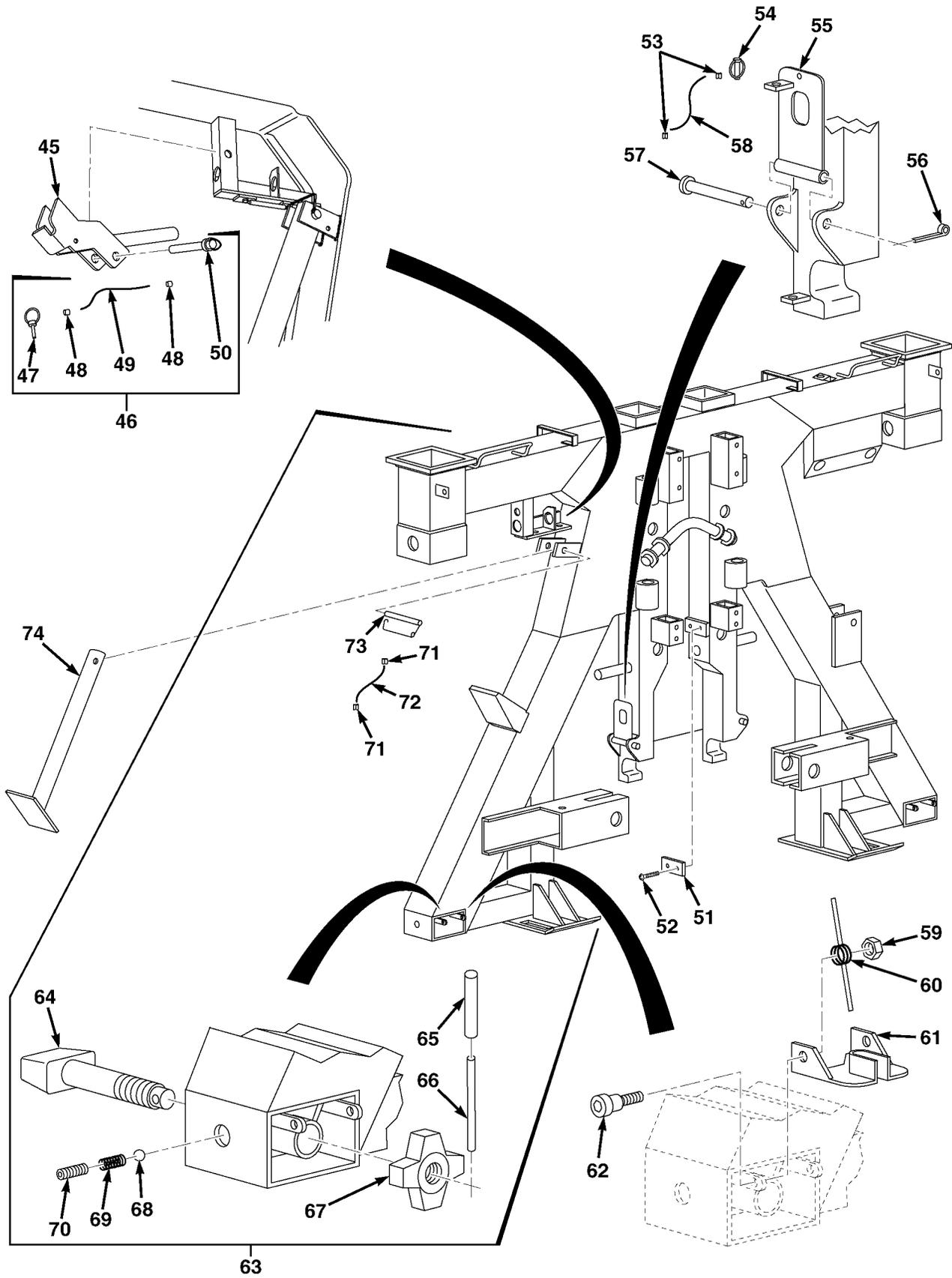

FIG. 59 FRONT LIFTING ADAPTER (SHEET 2 OF 2)

SECTION II

TM 9-2320-304-14&P C01

(1) ITEM NO	(2) SMR CODE	(3) CAGEC CAGEC	(4) PART NUMBER	(5) DESCRIPTION AND USABLE ON CODES(UOC)	(6) QTY
GROUP 3307 SPECIAL PURPOSE KIT FIG. 59 FRONT LIFTING ADAPTER					
1	PAOOO	45152	2172220W	HOOK, TOP LOCK	2
				UOC: LHU,	
2	XAOZZ	45152	2172250	.HOOK, TOP LOCK	1
				UOC: LHU,	
3	PFOOO	05FJ2	2172260	.PIN ASSEMBLY	1
				UOC: LHU,	
4	XAOZZ	45152	2172260XA	..PIN	1
				UOC: LHU,	
5	PAOZZ	37581	NIXROPRESS18-1C	..SWAGING SLEEVE, WIRE	2
				UOC: LHU,	
6	MOOZZ	45152	1533100-015	..ROPE, WIRE MAKE FROM WIRE P/N 879447-01 (18894), 15 IN. LG	1
				UOC: LHU,	
7	PAOZZ	96652	28-07	..PIN, SNAPPER	1
				UOC: LHU,	
8	PBOZZ	45152	2172170W	WELDMENT, SLIDE ARM	2
				UOC: LHU,	
9	PBOZZ	45152	3188569	HOOK, LIFTING	2
				UOC: LHU,	
10	PFOZZ	45152	3124496	COLLAR	1
				UOC: LHU,	
11	PAOOO	05FJ2	2176240	PIN, QUICK RELEASE	4
				UOC: LHU,	
12	XAOZZ	45152	2172640XA	.PIN	1
				UOC: LHU,	
13	MOOZZ	45152	1533100-022	..ROPE, WIRE MAKE FROM WIRE P/N 879447-01 (18894), 22 IN. LG	1
				UOC: LHU,	
14	PAOZZ	37581	NICROPRESS18-1C	..SWAGING SLEEVE, WIRE	2
				UOC: LHU,	
15	PAOZZ	96652	28-07	.PIN, SNAPPER	1
				UOC: LHU,	
16	PAOOO	45152	3122230	BRACKET, MOUNTING	2
				UOC: LHU,	
17	PAOZZ	45152	3117462	.HOOK, 6 FT LOCK	1
				UOC: LHU,	
18	PFOOO	05FJ2	2172260	.PIN ASSEMBLY	1
				UOC: LHU,	
19	PAOZZ	96652	28-07	..PIN, SNAPPER	1
				UOC: LHU,	
20	PAOZZ	37581	NICROPRESS18-1C	..SWAGING SLEEVE, WIRE	2
				UOC: LHU,	
21	XAOZZ	45152	2173040XA	..PIN	1
				UOC: LHU,	
22	MOOZZ	45152	1533100-015	..ROPE, WIRE MAKE FROM WIRE P/N 879447-01 (18894), 15 IN. LG	1
				UOC: LHU,	

SECTION II

TM 9-2320-304-14&P C01

(1) ITEM NO	(2) SMR CODE	(3) CAGEC	(4) PART NUMBER	(5) DESCRIPTION AND USABLE ON CODES(UOC)	(6) QTY
23	PFOOO	45152	3119747	STRUT,UPPER	1
				UOC: LHU,	
24	MOOOO	45152	1533100-026	.ROPE,WIRE MAKE FROM WIRE P/N 879447-01 (18894), 26 IN. LG	1
				UOC: LHU,	
25	PAOZZ	96652	28-07	.PIN,SNAPPER	2
				UOC: LHU,	
26	PAOZZ	96906	MS51844-43	.SWAG SLVE,WIRE ROPE	4
				UOC: LHU,	
27	PFOOO	05FJ2	2173040	.PIN ASSEMBLY	1
				UOC: LHU,	
28	XAOZZ	45152	2173040X1	..PIN	1
				UOC: LHU,	
29	MOOZZ	45152	1533100-013	..ROPE,WIRE MAKE FROM WIRE P/N 879447-01 (18894), 13 IN. LG	1
				UOC: LHU,	
30	PAOZZ	45152	EE40567	..PIN,LOCK	1
				UOC: LHU,	
31	PAOZZ	37581	NICROPRESS18-1C	..SWAGING SLEEVE,WIRE	2
				UOC: LHU,	
32	PAOOO	45152	3122231	BRACKET,MOUNTING	2
				UOC: LHU,	
33	XAOZZ	45152	3117461	,HOOK, TOP LOCK	1
				UOC: LHU,	
34	PFOZZ	05FJ2	2176430	.PIN ASSEMBLY	2
				UOC: LHU,	
35	XAOZZ	45152	2176430XA	..PIN ASSEMBLY	1
				UOC: LHU,	
36	MOOZZ	45152	1533100-015	..ROPE,WIRE MAKE FROM WIRE P/N 879447-01 (18894), 15 IN. LG	1
				UOC: LHU,	
37	PAOZZ	96652	28-07	..PIN,SNAPPER	1
				UOC: LHU,	
38	PAOZZ	37581	NICROPRESS18-1C	..SWAGING SLEEVE,WIRE	2
				UOC: LHU,	
39	PFOOO	45152	3217508	CONTAINER LOCK,REAR	2
				UOC: LHU,	
40	PFOOO	05FJ2	3123921	.PIN ASSEMBLY	1
				UOC: LHU,	
41	PAOZZ	45152	EE40567	..PIN,LOCK	1
				UOC: LHU,	
42	PAOZZ	37581	NICROPRESS18-1C	..SWAGING SLEEVE,WIRE	2
				UOC: LHU,	
43	XAOZZ	45152	3123921XA	..PIN	1
				UOC: LHU,	
44	MOOZZ	45152	1533100-021	..ROPE,WIRE MAKE FROM WIRE P/N 879447-01 (18894), 21 IN. LG	1
				UOC: LHU,	
45	PBOZZ	45152	3191030	LOCK,BAIL BAR	1
				UOC: LHU,	
46	PAOOO	05FJ2	2207830	PIN,SHOULDER	1
				UOC: LHU,	

SECTION II

TM 9-2320-304-14&P C01

(1) ITEM NO	(2) SMR CODE	(3) CAGEC	(4) PART NUMBER	(5) DESCRIPTION AND USABLE ON CODES(UOC)	(6) QTY
47	PAOZZ	45152	2207830XA	.PIN UOC: LHU,	1
48	PAOZZ	37581	NICROPRESS18-1C	.SWAGING SLEEVE,WIRE UOC: LHU,	2
49	MOOZZ	45152	1533100-018	.ROPE,WIRE MAKE FROM WIRE P/N 879447-01 (18894), 18 IN. LG UOC: LHU,	1
50	XAOZZ	45152	2207830XA	.PIN,STRAUGHT UOC: LHU,	1
51	PAOZZ	45152	3252505	WEAR PAD UOC: LHU,	2
52	PAOZZ	45152	1754220	SCREW,CAP,HEX HD 5/16-18 X 1-1/2 UOC: LHU,	8
53	PAOZZ	96906	MS51844-43	SWAG SLVE,WIRE ROPE UOC: LHU,	4
54	PAOZZ	0J7N2	LP0800	PIN,QUICK RELEASE UOC: LHU,	2
55	PFOZZ	45152	2176250W	LOCKING PLATE ASSY UOC: LHU,	2
56	PAOZZ	45152	1749HX	PIN,COTTER UOC: LHU,	4
57	PAOZZ	45152	2152250	PIN,HINGE UOC: LHU,	2
58	MOOZZ	45152	1533100-012	ROPE,WIRE MAKE FROM WIRE ROPE P/N 879447-01 (18894), 12 IN. LG UOC: LHU,	2
59	PAOZZ	06853	244095	NUT,PLAIN,HEX 5/16-18 UOC: LHU,	4
60	PAOZZ	45152	2232480	SPRING,TORSION UOC: LHU,	4
61	PBOZZ	45152	2235270W	BRACKET,ISO LOCK UOC: LHU,	2
62	PAOZZ	45152	2235380	BOLT,SHOULDER UOC: LHU,	4
63	PBFFF	45152	3117463	ADAPTER,FRONT LIFT UOC: LHU,	2
64	PBFZZ	65059	T15096A-100	.STEM UOC: LHU,	2
65	PAFZZ	80372	87024A0522	.TUBING,NONMETALLIC UOC: LHU,	2
66	PAFZZ	80372	87024A0521	.HANDLE,MANAL CNTRL UOC: LHU,	2
67	PAFZZ	65059	T15094A-100	.NUT,HAND UOC: LHU,	2
68	PFFZZ	65059	806PX15	.BALL UOC: LHU,	2
69	PAFZZ	65059	806PX12	.SPRING UOC: LHU,	2
70	PFFZZ	65059	8061508-1ZN	.SCREW,GRUB UOC: LHU,	2

SECTION II

TM 9-2320-304-14&P C01

(1) ITEM NO	(2) SMR CODE	(3) CAGEC	(4) PART NUMBER	(5) DESCRIPTION AND USABLE ON CODES(UOC)	(6) QTY
71	KFOZZ	06721	1737095	.SLEEVE,CRIMPING PART OF KIT P/N 175220-60	1
72	KFOZZ	45152	2008530-006	UOC: LHU, .CABLE,COATED PART OF KIT P/N 175220-60	1
73	PAFZZ	45152	1965220	UOC: LHU, .PIN,QUICK RELEASE	1
74	PFOZZ	45152	2242310W	UOC: LHU, STRUT,LOWER	1

END OF FIGURE

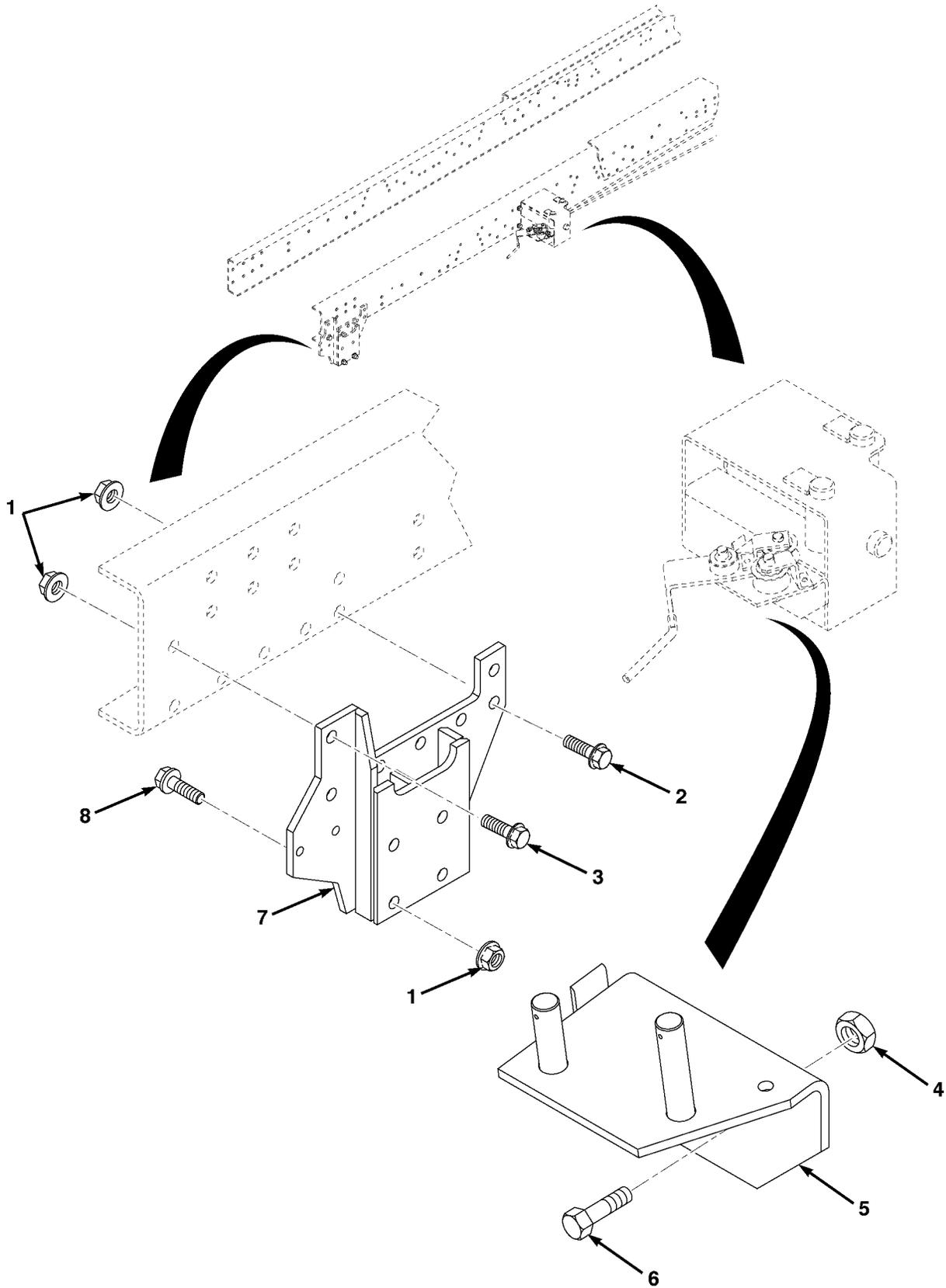

FIG. 60 SELF RECOVERY WINCH ASSEMBLY

SECTION II

TM 9-2320-304-14&P C01

(1) ITEM NO	(2) SMR CODE	(3) CAGEC	(4) PART NUMBER	(5) DESCRIPTION AND USABLE ON CODES(UOC)	(6) QTY
GROUP 3307 SPECIAL PURPOSE KIT					
FIG. 60 SELF RECOVERY WINCH ASSEMBLY					
1	PAOZZ	45152	110312A	NUT, SELF-LOCKING, EW, HEX	9
				UOC: LHU	
2	PAOZZ	45152	1337720	SCREW, CAP, EW, HEX	3
				UOC: LHU	
3	PAOZZ	45152	1317120	SCREW, CAP, EW, HEX	4
				UOC: LHU	
4	PAOZZ	45152	53925AX	NUT, HEX, LOCKING	3
				UOC: LHU	
5	PFOZZ	45152	3349157	PLATE ASSY, TENSIONER	1
				UOC: LHU	
6	PAOZZ	80204	B1821BH050C113N	SCREW, CAP, HEX HD	3
				UOC: LHU	
7	PFOZZ	45152	3340898	BRACKET, WINCH MTG	1
				UOC: LHU	
8	PAOZZ	45152	1337430	SCREW, CAP, EW, HEX	2
				UOC: LHU	

END OF FIGURE

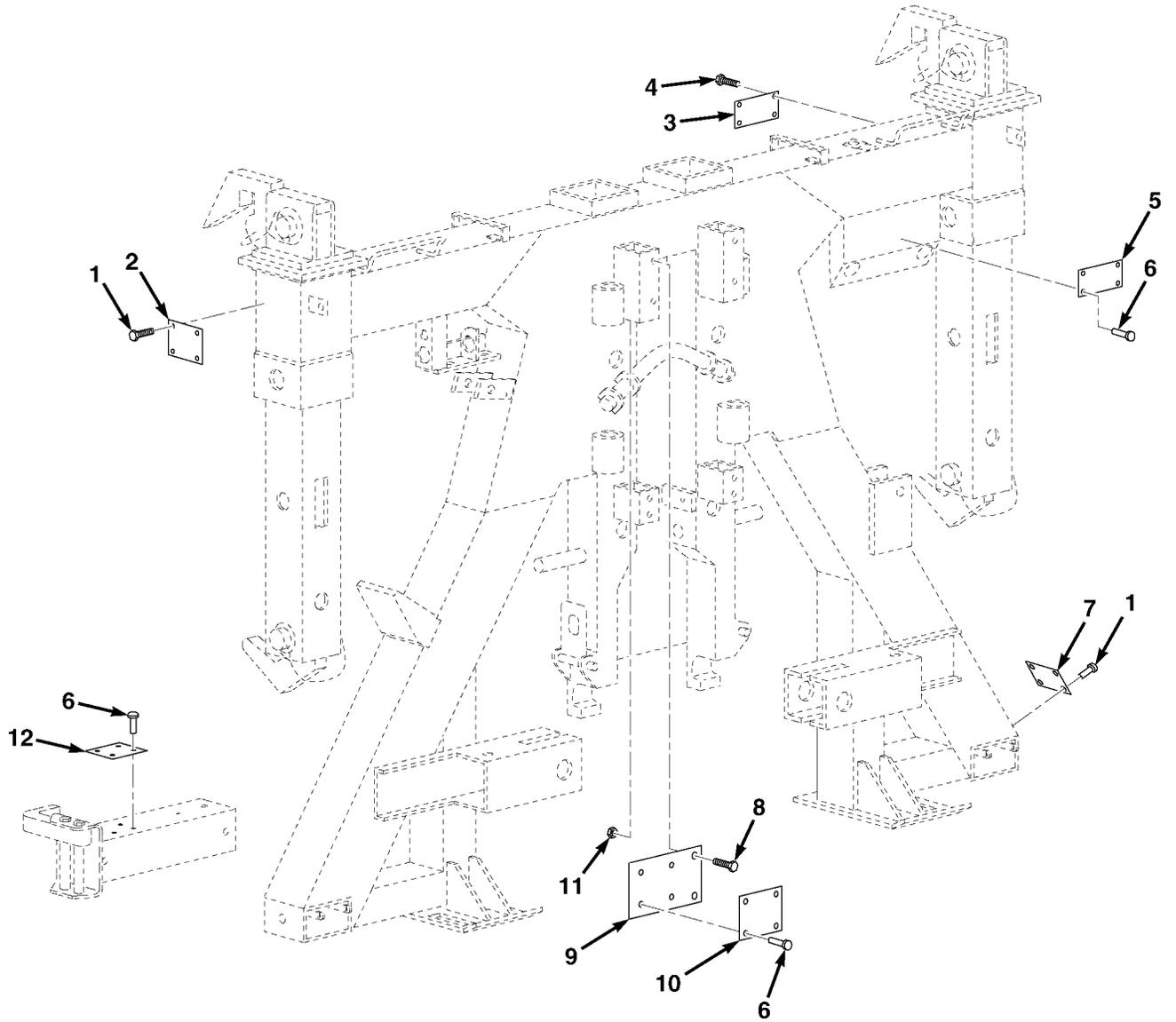

FIG. 61 DATA PLATES (SHEET 1 OF 2)

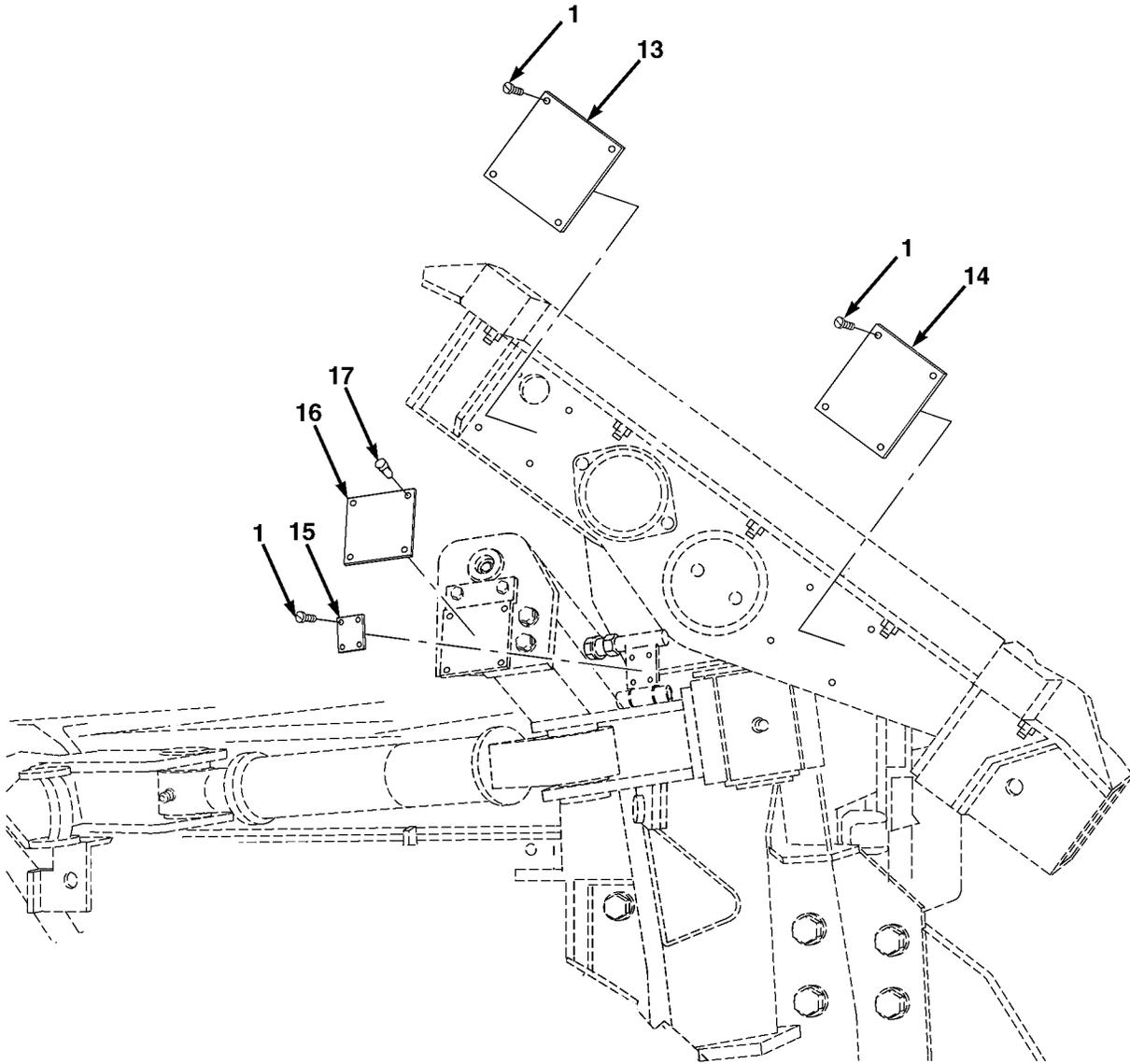

FIG. 61 DATA PLATES (SHEET 2 OF 2)

SECTION II

TM 9-2320-304-14&P C01

(1) ITEM NO	(2) SMR CODE	(3) CAGEC CAGEC	(4) PART NUMBER	(5) DESCRIPTION AND USABLE ON CODES(UOC)	(6) QTY
GROUP 3307 SPECIAL PURPOSE KIT					
FIG. 61 DATA PLATES					
1	PAOZZ	96906	MS21318-20	SCREW,DRIVE	20
				UOC: LHU	
2	PFOZZ	1DK67	3152164	DATA PLATE,LIFTING HOOK	2
				UOC: LHU	
3	PFOZZ	1DK67	3152167	DATA PLATE,WARNING	2
				UOC: LHU	
4	PAOZZ	05693	CCP-42	RIVET	8
				UOC: LHU	
5	PFOZZ	1DK67	3152159	DATA PLATE,LIFTING FRAME	1
				UOC: LHU	
6	PAOZZ	07707	SSD44-SSBS	RIVET	12
				UOC: LHU	
7	PFOZZ	45152	3367305	DATE PLATE,SHIPPING	1
				UOC: LHU	
8	PAOZZ	45152	1754220	SCREW,FLG,HEX	2
				UOC: LHU	
9	PFOZZ	45152	3373285	PLATE,DATA MTG	1
				UOC: LHU	
10	PFOZZ	1DK67	3152169	DATA PLATE,WARNING	2
				UOC: LHU	
11	PAOZZ	45152	1333510	NUT,FLG	2
				UOC: LHU	
12	PFOZZ	1DK67	3152161	DATA PLATE,TRANSIT LOCK	2
				UOC: LHU	
13	PFOZZ	1DK67	3117421	DATA PLATE,WARNING	2
				UOC: LHU	
14	PFOZZ	1DK67	3152168	DATA PLATE,WARNING	2
				UOC: LHU	
15	PFOZZ	1DK67	3152174	DATA PLATE,FLIP LOCK	2
				UOC: LHU	
16	PFOZZ	45152	1783190	DATA PLATE,WARNING	2
				UOC: LHU	
17	PAOZZ	3Z048	BTT43	RIVET,BLIND	8
				UOC: LHU	

END OF FIGURE

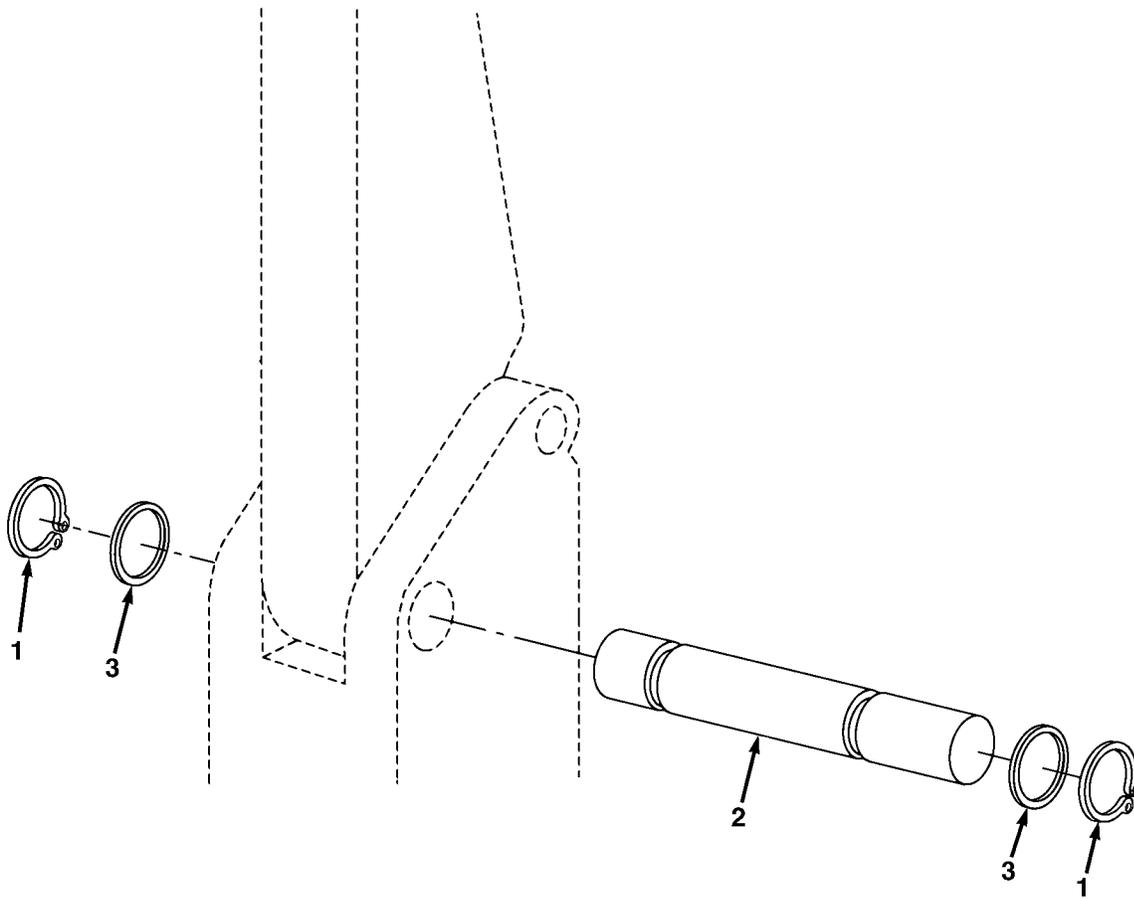

FIG. 62 CHU KIT PIVOT PIN

SECTION II

TM 9-2320-304-14&P C01

(1) ITEM NO	(2) SMR CODE	(3) CAGEC CAGEC	(4) PART NUMBER	(5) DESCRIPTION AND USABLE ON CODES(UOC)	(6) QTY
GROUP 3307 SPECIAL PURPOSE KIT					
FIG. 62 CHU KIT PIVOT PIN					
1	PAOZZ	96906	MS16624-4175	RING,RETAINING	2
				UOC: LHU	
2	PAOZZ	45152	2152010	PIN,GROOVED,HEADLESS	1
				UOC: LHU	
3	PAOZZ	45152	3227120	PACKING,PREFORMED	2
				UOC: LHU	

END OF FIGURE

SECTION II

TM 9-2320-304-14&P C01

(1) ITEM NO	(2) SMR CODE	(3) CAGEC CAGEC	(4) PART NUMBER	(5) DESCRIPTION AND USABLE ON CODES(UOC)	(6) QTY
				GROUP 94 REPAIR KITS GROUP 9401 REPAIR KITS FIG. KITS REPAIR KITS	
	PAOZZ	98343	175220-60	KIT, WIRE ROPE	1
				CABLE (1) 59-72	
				SLEEVE (1) 59-73	
	PFFZZ	63899	430		
457B				KIT, SEAL	1
				WIPER, ROD (1) 40-5	
				SEAL, ROD (1) 40-6	
				STEP SEAL, KR ASSY (1) 40-7	
				PACKING, PREFORMED (1) 40-8	
				RING, BACKUP (1) 40-9	
				RING, WEAR (2) 40-10	
				RING, WEAR (2) 40-13	
				SEAL ASSY, PISTON (1) 40-14	
				WIPER, ROD (1) 30-5	
				SEAL, ROD (1) 30-6	
				STEP, SEAL, KR ASSY (1) 30-7	
				PACKING, PREFORMED (1) 30-8	
				RING, BACKUP (1) 30-9	
				RING, WEAR (1) 30-10	
				RING, WEAR (1) 30-11	
				SEAL ASSY, PISTON (1) 30-12	
	PFFZZ	0FHH8	9S000104	KIT, SEAL	1
				PACKING, PREFORMED (2) 31-16	
				PACKING, PREFORMED (2) 31-17	
	PFFZZ	0FHH8	9S000105	KIT, SEAL	1
				PACKING, PREFORMED (1) 41-6	
				PACKING, PREFORMED (1) 41-12	
	PFFZZ	0FHH8	9S000106	KIT, SEAL	1
				PACKING, PREFORMED (1) 32-3	
				PACKING, PREFORMED (1) 32-5	
				PACKING, PREFORMED (1) 32-7	
				PACKING, PREFORMED (1) 32-9	
				PACKING, PREFORMED (1) 32-11	
				PACKING, PREFORMED (5) 32-30	
				PACKING, PREFORMED (4) 32-33	
				PACKING, PREFORMED (1) 32-37	
				PACKING, PREFORMED (1) 32-38	
	PFFZZ	0FHH8	SK3-0002N-1	KIT, SEAL	1
				PACKING, PREFORMED (1) 32-20	
				PACKING, PREFORMED (1) 32-22	
				RING, BACKUP (1) 32-21	
	PFFZZ	0FHH8	SK3-0017N-1	KIT, SEAL	1
				PACKING, PREFORMED (1) 41-8	
				RING, BACKUP (2) 41-9	
				PACKING, PREFORMED (1) 41-10	

SECTION II

TM 9-2320-304-14&P C01

(1) ITEM NO	(2) SMR CODE	(3) CAGEC	(4) PART NUMBER	(5) DESCRIPTION AND USABLE ON CODES(UOC)	(6) QTY
	PFFZZ	0FHH8	SK3-0024N-1	KIT, SEAL	1
				PACKING, PREFORMED (1) 32-13	
				PACKING, PREFORMED (1) 32-14	
				RING, BACKUP (2) 32-15	
				PACKING, PREFORMED (1) 32-16	
				RING, BACKUP (1) 32-17	
	PFFZZ	0FHH8	SK3-0035N-1	KIT, SEAL	1
				PACKING, PREFORMED (1) 32-24	
				RING, BACKUP (1) 32-25	
				RING, BACKUP (1) 32-26	
				PACKING, PREFORMED (1) 32-27	
				PACKING, PREFORMED (1) 32-28	
	PFFZZ	0FHH8	SK3-0039N-1	KIT, SEAL	1
				PACKING, PREFORMED (1) 31-3	
				RING, BACKUP (1) 31-4	
				PACKING, PREFORMED (1) 31-5	
				RING, BACKUP (2) 31-6	
				PACKING, PREFORMED (1) 31-7	
	PFFZZ	0FHH8	SK3-0088N-1	KIT, SEAL	1
				PACKING, PREFORMED (1) 32-43	
				RING, BACKUP (2) 31-9	
				PACKING, PREFORMED (1) 31-10	
				PACKING, PREFORMED (1) 31-11	
				PACKING, PREFORMED (1) 32-41	
				RING, BACKUP (2) 32-42	

SECTION II

TM 9-2320-304-14&P

(1) ITEM NO	(2) SMR CODE	(3) CAGEC CAGEC	(4) PART NUMBER	(5) DESCRIPTION AND USABLE ON CODES(UOC)	(6) QTY
GROUP 95 GENERAL USE STANDARDIZED PARTS					
GROUP 9501 HARDWARE SUPPLIES AND BULK					
MATERIEL					
FIG. BULK BULK MATERIALS					
1	PAFZZ	80535	031-0424	CHAIN,WELDED	V
2	PAOZZ	45152	1533100	ROPE	V
3	PAOZZ	45152	121782A	WIRE,ELECTRICAL	V
4	PAFZZ	77060	R-64932	WIRE,ELECTRICAL	V

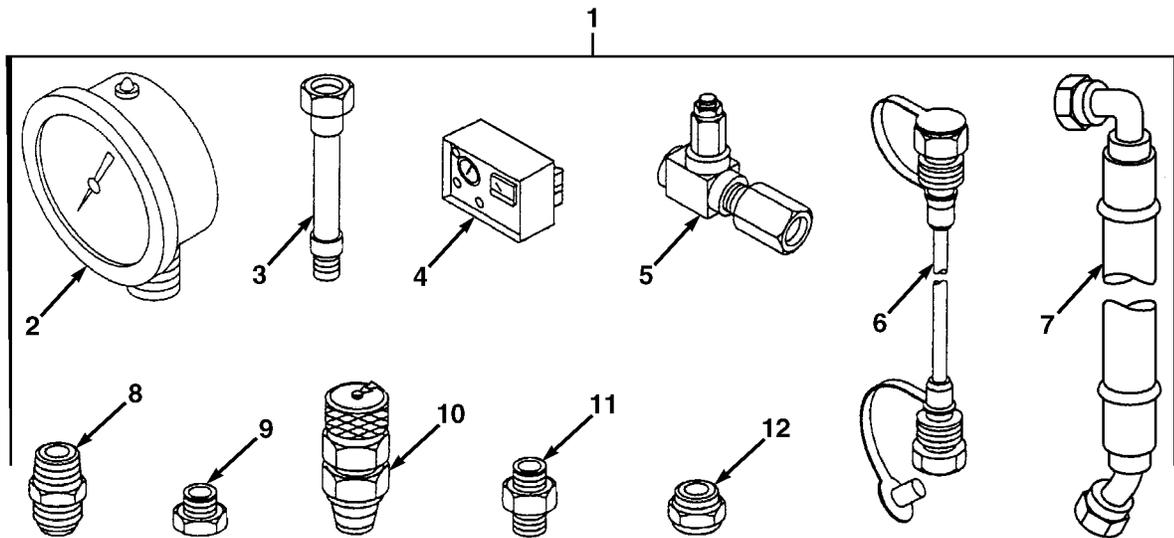

FIG. 63 SPECIAL TOOLS

SECTION III

TM 9-2320-304-14&P C01

(1) ITEM NO	(2) SMR CODE	(3) CAGEC CAGEC	(4) PART NUMBER	(5) DESCRIPTION AND USABLE ON CODES(UOC)	(6) QTY
GROUP 2604 SPECIAL TOOLS					
FIG. 63 SPECIAL TOOLS					
1	PAFFF	45152	4SK777	KIT,PRESSURE TEST	1
2	PAFZZ	61349	151467-P540	.GAGE,PRESSURE	1
3	PAFZZ	61349	GAH20-1/4NPT-V	.ADAPTER,DIRECT GAGE	1
4	PAFZZ	0LB04	FT6370	.FLOWMETER	1
5	PAFZZ	99752	PLV-255B (PRESET TO 1950 PSI)	.PRESSURE LTG SNUBBE	1
6	PAFZZ	53790	HFF20-060	.HOSE, NONMETALLIC	1
7	PAFZZ	45152	3056241	.HOSE ASSEMBLY, NONME	2
8	PAFZZ	01276	2027-8-8S	.ADAPTER	2
9	PAFZZ	01276	900599-8S	.PLUG	4
10	PAFZZ	01276	TCM20-1/2UNF-V	.ADAPTER	3
11	PAFZZ	01276	202702-16-8S	.ADAPTER	2
12	PAFZZ	01276	210292-8S	.CAP	4

END OF FIGURE

CROSS-REFERENCE INDEXES

STOCK NUMBER	NATIONAL STOCK NUMBER INDEX		STOCK NUMBER	FIG.	ITEM
	FIG.	ITEM			
5999-00-057-2929	18	7	5940-00-557-4345	17	2
	19	8		15	3
5305-00-059-3660	9	7	5310-00-582-5965	8	19
	10	14		37	2
5310-00-061-1258	10	23		50	17
5310-00-061-4650	26	11	5330-00-588-0892	5	28
5310-01-061-5301	29	50		7	10
5305-00-068-0508	53	13	5940-00-620-9780	5	31
	54	11		5	9
5940-00-113-8183	19	9		16	8
5940-00-143-4777	47	5	5935-00-655-3120	50	13
5940-00-143-4794	51	12	5975-00-660-5962	18	4
5935-00-146-5811	20	2		19	4
5310-00-167-0767	34	6	5935-00-677-4444	17	3
4730-00-173-1881	33	8	5940-00-682-2445	19	5
5320-00-173-8625	61	6		15	2
5325-00-175-1315	29	24		16	9
4730-00-177-5894	43	3	5935-00-691-5591	18	5
5315-00-182-6769	57	16		19	6
	59	30		51	13
	59	41	5305-00-732-0511	60	6
5310-00-185-6345	29	19	5325-00-722-8570	57	10
5310-00-185-6389	21	11	5310-00-775-5139	7	2
5315-00-187-9420	22	5	5310-00-809-4058	8	3
9905-00-205-2795	10	19		37	3
	25	4		50	24
5310-00-207-9341	3	5	5306-00-816-5272	38	1
5310-00-208-1918	26	9	5970-00-833-8562	18	3
5340-00-224-1204	35	11		19	3
5331-00-228-7196	33	11	5310-00-833-8567	18	6
	33	7		19	7
	43	6	4730-00-853-1182	31	18
	33	9	5940-00-874-9033	5	32
5305-00-253-5614	28	11		5	20
4730-00-266-6772	36	3		6	26
4030-00-278-0715	22	4		6	22
9905-00-282-3639	27	1		6	10
5325-00-282-7149	29	27		6	18
5930-00-292-0520	17	6		6	14
5331-00-395-5737	42	9		6	6
5940-00-399-6676	18	2		5	3
	19	2		5	6
	17	5		6	2
5340-00-404-4100	34	16		5	13
5315-00-465-8928	57	6		5	8
	62	1		7	7
5305-00-470-3321	34	9		8	7
	7	3		8	11
5310-00-542-0087	5	18		8	13
	7	13	5310-00-880-0626	29	15

CROSS-REFERENCE INDEXES

STOCK NUMBER	NATIONAL STOCK NUMBER INDEX		STOCK NUMBER	FIG. ITEM	
	FIG.	ITEM		FIG.	ITEM
	24	18	5935-01-112-9782	14	2
5305-00-889-3001	5	26		20	3
	7	5		20	4
4730-00-917-4794	33	4	5331-01-116-8112	42	8
5315-00-917-6226	29	10	5305-01-118-8860	34	28
5325-00-922-6273	51	25	5310-01-119-1811	5	27
4730-00-925-8039	41	3		7	15
5325-00-925-9838	10	25	5310-01-129-0450	34	13
5310-00-933-6120	36	4		10	5
5305-00-958-5246	34	3		29	14
5310-00-984-3806	26	6	2540-01-131-6242	24	19
5305-00-984-6210	50	3	5310-01-133-2130	21	8
5305-00-984-6211	5	17	5305-01-134-2052	28	4
5305-00-988-1171	50	23	2540-01-134-3714	25	7
5305-00-988-1724	25	3	5310-01-141-5565	38	9
5310-01-006-5018	63	12	5305-01-147-9723	58	26
4730-01-011-7736	33	6	5975-01-148-4607	17	4
5310-01-038-2294	29	41	5305-01-149-1934	22	10
5340-01-038-9481	53	15	5310-01-150-5918	29	30
	54	13		22	6
	57	18	5306-01-150-7726	29	45
5310-01-061-7452	42	3	5305-01-150-7736	56	2
	38	3		58	14
5305-01-061-7910	29	13	5310-01-151-1036	53	28
5305-01-062-1017	34	8		57	21
	26	3	5340-01-151-8391	24	9
5310-01-062-3379	34	27	5305-01-152-4223	60	8
5310-01-063-8970	10	4	2540-01-152-7764	26	2
5305-01-064-5470	8	20	5340-01-153-0313	24	2
5310-01-066-6759	10	6	5305-01-154-4323	22	12
	8	5	5305-01-155-3478	29	31
	50	26		22	13
5310-01-068-8446	21	2	5305-01-155-4357	58	22
	34	7	5305-01-155-5237	10	18
	42	2	5306-01-155-9765	55	15
	38	2	4730-01-156-4835	42	4
5935-01-075-9503	13	2	5306-01-156-5429	29	49
5310-01-080-9786	5	16	5305-01-156-5440	56	15
5340-01-081-1718	24	8		58	21
5305-01-082-0049	21	1		58	25
5320-01-083-9619	61	4		60	2
5306-01-084-5390	10	24	5305-01-156-5445	24	12
5306-01-086-2368	29	43	5340-01-156-6776	26	5
5305-01-086-3551	5	35	9905-01-157-1026	28	6
	7	12	5305-01-157-5624	24	7
5340-01-092-1637	26	12	5306-01-159-6549	29	44
5310-01-105-7229	59	59	5310-01-159-8178	24	10
5306-01-106-7496	23	2		23	7
5310-01-111-0645	29	47		22	3
	23	4	5305-01-159-8544	27	2

CROSS-REFERENCE INDEXES

STOCK NUMBER	NATIONAL STOCK NUMBER INDEX		STOCK NUMBER	FIG.	ITEM
	FIG.	ITEM			
4730-01-160-6708	63	11	4730-01-242-2840	63	8
5306-01-164-7437	38	10	5330-01-244-2273	33	13
5305-01-165-3297	54	1		33	5
5310-01-166-1708	60	4		42	5
5305-01-166-4410	5	24	5305-01-249-8564	10	17
5305-01-167-9408	22	1		26	1
5330-01-168-0885	33	17		3	1
5340-01-168-7285	34	2	4030-01-258-0467	29	32
5331-01-168-8112	36	2	5305-01-274-0028	56	4
5340-01-172-1566	38	4	5305-01-280-7901	8	2
5935-01-174-1235	5	33	5306-01-287-5714	34	15
	5	22		35	8
	7	9	5306-01-287-5715	34	30
	50	12		26	8
5342-01-175-0316	34	17	5310-01-288-1116	34	23
5305-01-185-8668	22	9		24	15
5305-01-196-8088	22	11		26	7
	56	13	5940-01-288-4774	16	2
5305-01-203-8360	37	1	5310-01-288-5096	5	11
	26	4		34	10
5340-01-204-4888	29	39		10	7
5975-01-207-0230	5	29	7690-01-292-9726	2	7
	7	11	5305-01-296-0341	34	12
5935-01-208-3507	5	14	5935-01-297-2794	11	2
5935-01-211-4440	5	34	5305-01-306-3507	50	18
5935-01-213-1826	1	2	4935-01-308-7866	44	8
	12	3		44	11
5310-01-214-4946	29	42	5975-01-310-5011	1	7
5315-01-215-7505	58	30		12	4
5310-01-216-2799	29	9	4030-01-315-7354	57	14
4730-01-217-1115	29	5		59	5
4730-01-220-8297	33	15		59	14
	43	2		59	20
4730-01-221-2080	33	14		59	31
	43	1		59	38
2540-01-222-9653	25	2		59	42
5340-01-224-8368	10	9		59	48
5975-01-226-8078	44	7	4730-01-316-9239	63	9
5340-01-231-3916	37	4	5340-01-317-5450	34	18
5940-01-234-7272	1	6	5935-01-317-6762	5	21
5306-01-236-1585	55	5		7	8
	56	11	5961-01-318-9764	5	23
	57	22	5935-01-319-5222	1	10
5360-01-236-2072	23	9		12	6
5305-01-236-5107	58	28		16	3
4010-01-237-7544	BULK	1	5999-01-319-7394	16	5
4730-01-241-4650	33	16	6350-01-319-9161	17	9
			4730-01-327-7081	33	1
5305-01-242-0655	57	3	5305-01-328-4384	21	7
4730-01-242-1290	33	12	5975-01-333-5974	16	4

CROSS-REFERENCE INDEXES

STOCK NUMBER	NATIONAL STOCK NUMBER INDEX		STOCK NUMBER	FIG. ITEM	
	FIG.	ITEM		FIG.	ITEM
5305-01-337-9120	10	28		30	2
	34	21	5340-01-355-3713	34	1
	17	10	5340-01-355-3733	38	5
5935-01-339-3227	44	4	5315-01-355-3744	29	21
5975-01-339-9574	16	6	5340-01-355-3794	21	3
5305-01-340-0225	35	10	5330-01-355-4809	6	27
5305-01-340-5061	34	24		6	23
5310-01-340-5671	35	7		6	11
	24	20		6	19
	35	5		6	15
5306-01-341-0712	23	6		6	7
5305-01-341-3090	58	27		6	3
	1	11		8	9
5940-01-342-0712	12	5		8	16
	29	17	4730-01-355-5140	31	1
5310-01-342-8595	29	40	5365-01-355-5141	32	2
5310-01-343-5712	2	5		41	11
5935-01-344-4901	42	1	5365-01-355-5142	32	4
5305-01-344-5532	34	19	5340-01-355-5248	21	4
5305-01-344-8899	10	3	5340-01-355-5259	34	31
	17	7	5340-01-355-5268	34	11
	24	4	5999-01-355-6670	12	7
	34	20	5340-01-355-6821	8	18
	34	4	5930-01-355-7099	32	36
5310-01-346-9445	10	26	5930-01-355-7110	1	12
	10	21	5930-01-355-7119	5	4
	24	14	5950-01-355-7136	32	39
	25	5		31	13
			5930-01-355-7309	1	13
4010-01-348-6039	KITS		5365-01-355-7357	29	26
5945-01-351-4593	5	15	5365-01-355-7358	29	23
5935-01-351-4732	16	7	5935-01-355-7505	6	28
5320-01-351-5621	28	2		6	24
5305-01-352-2066	9	8		6	12
5310-01-352-7732	5	36		6	20
	7	14		6	16
5940-01-353-3175	44	9		6	8
5310-01-353-6045	56	5		6	4
5940-01-353-6476	50	7		8	8
5305-01-353-8267	24	1		8	15
5305-01-353-8268	24	5		8	1
5340-01-354-0175	26	10	5340-01-355-8246	8	5
6220-01-354-7462	2	2	5340-01-355-8247	37	10
5305-01-355-1355	32	31	5310-01-355-8794	21	20
5305-01-355-1360	32	34	5310-01-355-8798	31	15
5305-01-355-1428	34	29		41	12
5305-01-355-2641	40	3	3120-01-355-8843	21	2
	30	3	4820-01-355-8975	31	8
5305-01-355-2642	40	12	4810-01-355-8979	31	12
	30	14	4820-01-355-8980	31	11
5305-01-355-2643	40	2	4730-01-355-9000	38	

CROSS-REFERENCE INDEXES

STOCK NUMBER	NATIONAL STOCK NUMBER INDEX		STOCK NUMBER	FIG.	ITEM
	FIG.	ITEM			
4730-01-355-9003	33	10	5940-01-357-9200	5	25
4730-01-355-9043	32	8	5940-01-358-1127	7	1
5330-01-355-9248	KITS		3990-01-358-1146	21	5
5330-01-355-9269	29	3	2540-01-358-1218	29	1
5340-01-355-9368	29	12	5970-01-358-3441	8	10
5365-01-355-9529	29	4		8	14
5331-01-355-9911	31	17	5315-01-358-3736	58	37
	41	6		59	7
5365-01-355-9965	40	4		59	15
	30	4		59	19
4810-01-356-0501	32	12		59	25
4810-01-356-0505	32	40		59	37
4730-01-356-0687	42	7	9905-01-358-4270	28	13
4730-01-356-1018	42	10	5340-01-358-6695	10	22
4820-01-356-2632	32	19	9905-01-358-6746	28	14
4810-01-356-2637	41	7	4710-01-358-6946	38	8
4820-01-356-2638	41	13	9905-01-358-7089	28	12
4730-01-356-2653	39	1	6240-01-358-7127	2	8
3040-01-356-2707	40	1	6110-01-358-9389	3	3
4810-01-356-4487	32	29	5303-01-359-7965	53	12
4720-01-356-4555	42	6	4710-01-360-2292	37	6
4720-01-356-4556	41	1	4710-01-360-2293	38	7
4720-01-356-4557	41	2	4710-01-360-9502	38	14
3040-01-356-4589	29	16	5315-01-361-2721	29	6
2530-01-356-4613	29	25	4710-01-361-3985	38	6
2530-01-356-4614	29	22	5365-01-361-5599	32	6
4820-01-356-5559	32	23	9905-01-361-8611	28	8
4820-01-356-6765	41	5	6150-01-362-5215	11	1
4720-01-356-6804	38	13	6150-01-362-5216	20	1
3040-01-356-6837	29	28	6150-01-362-5217	7	6
4710-01-356-7535	37	7	6150-01-362-5218	8	12
5340-01-356-8373	29	11	6150-01-362-5219	5	30
5340-01-356-8487	24	11	6150-01-362-5220	5	19
4730-01-356-8646	36	1	6150-01-362-5221	6	21
4710-01-356-8755	33	3	6150-01-362-5222	6	9
4710-01-356-8756	33	2	6150-01-362-5223	6	17
4730-01-356-9875	32	1	6150-01-362-5224	6	13
5935-01-357-1036	4	2	6150-01-362-5225	6	5
3990-01-357-1944	21	9	6150-01-362-5226	6	1
2510-01-357-2507	24	13	6150-01-362-5227	14	1
5305-01-357-4682	53	24	6150-01-362-5228	13	1
2510-01-357-5691	24	16	6150-01-362-5240	5	1
5330-01-357-7510	KITS		6150-01-362-6365	12	1
5330-01-357-7511	KITS		6150-01-362-6367	6	25
5330-01-357-7512	KITS		5330-01-363-0667	KITS	
5330-01-357-7903	KITS		6150-01-363-2162	8	6
5330-01-357-7904	KITS		5340-01-363-6139	21	6
2510-01-357-8795	24	6	5340-01-363-6141	35	6
2510-01-357-8796	24	6	5315-01-363-6984	29	34
5940-01-357-9199	7	4	5315-01-363-7062	29	35

CROSS-REFERENCE INDEXES

STOCK NUMBER	NATIONAL STOCK NUMBER INDEX		STOCK NUMBER	FIG. ITEM	
	FIG.	ITEM		FIG.	ITEM
5340-01-364-1959	24	3	5315-01-429-7284	59	34
5340-01-364-4343	24	3	5315-01-429-7296	59	11
2510-01-364-4489	24	17	2510-01-429-9684	59	1
6240-01-365-7995	2	1	5315-01-431-0602	59	46
6685-01-368-7134	63	2	5305-01-431-5149	53	4
5940-01-368-9579	17	8	5315-01-431-9369	59	3
6220-01-369-9849	2	3		59	18
6220-01-369-9851	2	4	4730-01-450-5139	58	31
6220-01-369-9852	2	6		59	71
5340-01-372-3982	40	11	2510-01-453-8548	29	29
	30	13	4030-01-456-1150	29	8
5999-01-372-4955	50	9	5331-01-457-1834	32	5
5330-01-372-8377	KITS			32	37
5930-01-372-9489	1	1		32	41
4730-01-372-9701	63	10		31	11
4730-01-373-0474	63	3		41	8
3040-01-373-0500	40	14	5331-01-457-3314	32	9
	30	12	2510-01-457-5270	29	53
4820-01-373-5688	63	5	5310-01-457-8573	23	8
4810-01-373-7257	32	32	5310-01-458-0248	29	18
4720-01-373-9871	44	6		50	11
3040-01-374-4803	30	1	5340-01-458-6165	59	55
5340-01-375-6932	59	66	5305-01-458-6171	59	62
9330-01-375-9240	59	65	5315-01-459-1409	52	2
5935-01-376-1003	8	4	6150-01-459-1811	9	3
6680-01-383-0784	63	4		10	12
5310-01-361-8388	3	4	5980-01-459-2073	9	2
5342-01-384-9511	10	20		10	13
5340-01-389-3462	32	10	5305-01-459-3059	31	21
	31	15		41	14
5340-01-389-3537	32	18	9905-01-459-4979	28	1
	32	35	5310-01-459-6126	21	13
	31	14	5310-01-459-6206	21	14
5330-01-393-5075	KITS		5315-01-459-7337	59	57
5340-01-394-2420	34	14	5315-01-459-7340	53	20
5340-01-394-2421	34	25		59	56
5330-01-394-3549	KITS		5365-01-459-8230	48	1
5365-01-394-3553	34	5	5331-01-460-9137	32	7
5325-01-395-0827	50	19	5331-01-460-9149	32	30
5315-01-395-4217	59	54		32	38
3910-01-397-5277	21	15	2510-01-461-2924	59	63
5935-01-408-2896	12	2	3120-01-461-8627	57	7
5670-01-408-8386	23	1	3120-01-461-8639	59	10
5975-01-413-6387	5	10	6150-01-461-9183	44	1
2590-01-414-3179	29	2	6150-01-461-9229	45	1
5340-01-419-1315	10	8	2530-01-462-0714	55	13
5310-01-420-7626	39	3		57	9
5315-01-429-6971	57	12	4710-01-462-1238	55	2
	58	40	5930-01-462-1321	53	11
	59	27	3120-01-462-1431	54	7

CROSS-REFERENCE INDEXES

STOCK NUMBER	NATIONAL STOCK NUMBER INDEX		STOCK NUMBER	FIG.	ITEM
	FIG.	ITEM			
3120-01-462-1442	54	4	5315-02-462-5888	53	21
5940-01-462-1717	44	6	5315-01-462-5890	53	22
5940-01-462-1718	44	5	5315-01-462-5964	54	16
	44	12		55	7
5340-01-462-1757	59	45	5315-01-462-5971	53	19
5340-01-462-1761	56	10	5340-01-462-6138	48	3
5340-01-462-1762	56	1	5340-01-462-6483	54	5
5351-01-462-2073	62	2	5310-01-462-6502	53	16
4730-01-462-2632	43	5	5310-01-462-6513	54	3
5935-01-462-3056	50	8	5310-01-462-6509	54	9
5340-01-462-3360	48	4	5315-01-462-6628	54	5
5340-01-462-3362	59	8	5340-01-462-6637	53	3
5340-01-462-3363	59	61	5340-01-462-6645	53	3
5340-01-462-3365	56	1	5325-01-462-7182	57	8
5340-01-462-3367	56	9	5360-01-462-7636	53	7
2510-01-462-4677	57	11	5315-01-462-7513	53	8
2510-01-462-4681	59	74	5315-01-462-7515	53	5
2510-01-462-4683	55	12	5360-01-462-8548	53	23
2510-01-462-4688	59	23	5315-01-463-0139	59	40
3040-01-462-5029	57	19	5330-01-463-1204	54	6
3040-01-462-5032	53	29	5330-01-462-1206	54	14
5340-01-462-5443	56	20	5330-01-463-1208	54	2
5340-01-462-5702	56	16	9905-01-463-1432	61	5
5340-01-462-5703	53	1	5930-01-464-9574	8	21
5340-01-462-5704	53	1		8	17
5340-01-462-5709	59	32	5935-01-464-9581	4	1
5340-01-462-5711	59	16	5315-01-480-7516	58	34
2590-01-462-5751	58	44			

CROSS-REFERENCE INDEXES

CAGEC	PART NUMBER	PART NUMBER INDEX STOCK NUMBER	FIG.	ITEM
78276	ALS7-1024-130	5326-01-395-08211	50	19
88044	AN365-1024A	5310-00-208-1918	26	9
88044	AN970-5	5310-00-167-0767	34	6
71400	A 203118-NL	5940-01-357-9200	5	25
K0274	A12-12JICBHMER	4730-01-356-2653	39	1
K0274	A12-12JICMSCR	4730-01-355-9000	38	11
K0274	A16-17DBMSCR	4730-01-356-0687	42	7
K0274	A16-17J1CBHR	4730-01-356-8646	36	1
71400	A203107-NL	5940-01-357-9199	7	4
0FHH8	A4B125T053525N	4810-01-356-0501	32	12
0FHH8	A5B060014350N	4810-01-356-2637	41	7
71468	BFR18-1S-1	5935-00-655-3120	50	13
71468	BFR20-29S-1	5935-01-462-3056	50	8
3Z048	BTT43	5320-01-351-5621	28	2
			61	17
80204	B1821BHO25CO75N	5305-00-068-0508	53	13
			54	11
80204	B1821BHO50C113N	5305-00-732-0511	60	6
80204	B1821BH025C175N	5305-01-203-8360	26	4
93907	B71-10015-002	5305-01-352-2066	9	8
71468	CA3100F18-1SF80	5935-01-112-9792	20	4
71468	CA3100R20-29PF80	5935-01-408-2896	12	2
71468	CA3101F10SL-3PF8	5935-01-357-1036	4	2
71468	CA3101F18-1SF80		46	3
71468	CA3102R18-1S-F80	5935-01-317-6762	5	21
			7	8
71468	CA3106F10SL3SF80	5935-00-146-5811	20	2
			44	3
			46	4
71468	CA3106F18-1PF80	5935-01-112-9782	14	2
			20	3
			44	2
			46	2
71468	CA3106F20-29S-F8	5935-01-297-2794	11	2
05693	CCP-42	5320-01-083-9619	61	4
0FHH8	CCS024D	5950-01-355-7136	32	39
			31	13
53606	CJV-0809	5340-01-317-5450	34	18
75272	COVO50971	5340-01-038-9481	53	15
			54	13
			57	18
75272	COV-0713		10	27
			51	22
75272	COV2113	5340-00-404-4100	34	16
28520	DP-1750-2773		58	23
53790	DP-2	5340-01-355-6821	8	18
53790	DP-3	5340-01-231-3916	37	4
28520	DP-312	5340-01-081-1718	24	8
11139	DTO4-4P-RT		50	14
11139	DTO6-4S		50	10
0NYH2	D-191-7-1	6110-01-358-9389	3	3

CROSS-REFERENCE INDEXES

CAGEC	PART NUMBER	PART NUMBER INDEX STOCK NUMBER	FIG.	ITEM
0FHH8	D2A60-5.0N	4820-01-356-2632	32	19
45152	EE103647	5306-01-086-2368	29	43
45152	EE40567	5315-00-182-6769	57	16
			59	30
			59	41
45152	EE-105327	5305-01-086-3551	5	35
			7	12
82484	E-013-003	6240-01-358-7127	2	8
82484	E-013-004	6240-01-365-7995	2	1
82484	E-131-001	6220-01-354-7462	2	2
81901	E1117-525	5930-01-462-1321	53	11
0FHH8	E2A50Y4350NMK2	4820-01-355-8975	31	2
0FHH8	E2E125Z4350NMK2	4820-01-356-5559	32	23
01276	FD45-1168-16-16	4730-01-220-8297	33	15
			43	2
01276	FD45-1169-16-16	4730-01-221-2080	33	14
			43	1
01276	FK1328HHH0224	4720-01-356-6804	38	13
01276	FK1329HHH0244	4720-01-356-4555	42	6
0LB04	FT6370	6680-01-383-0784	63	4
01276	FU680HHH0260180	4720-01-356-4556	41	1
01276	FU681HHH0300180	4720-01-356-4557	41	2
61349	GAH20-1/4NPT-V	4730-01-373-0474	63	3
53790	GD-3D	5340-01-172-1566	38	4
2K272	GE45E8-2RS	3120-01-461-8627	57	7
2K272	GLY.PG657070A	3120-01-462-1431	54	7
2K272	GLY.PG808560A	5365-01-355-9529	29	4
			53	26
0FHH8	GS028000N	4810-01-355-8979	31	8
0FHH8	GS028510N	4810-01-356-0505	32	40
53790	HFF20-060	4720-01-373-9871	63	6
83014	H360-5-2	5340-01-151-8391	24	9
83014	H360-6-2	5340-01-224-8368	10	9
83014	H360K2598	5340-01-419-1315	10	8
			51	37
OJ7N2	LPO800	5315-01-395-4217	59	54
96906	MS16624-250	5325-00-175-1315	29	24
			53	17
			54	10
96906	MS16624-4175	5315-00-465-8928	57	6
			62	1
96906	MS19068-121	5310-00-185-6345	29	19
96906	MS21318-20	5305-00-253-5614	28	11
			61	1
96906	MS24665-15	5315-00-917-6226	29	10
96906	MS24665-624		25	6
96906	MS24665-717	5315-00-187-9420	22	5
96906	MS25036-112	5940-00-143-4794	51	12
96906	MS25036-113	5940-00-113-8183	19	9
			47	9
96906	MS25036-118	5940-00-557-4345	17	2

SECTION IV

TM 9-2320-304-14&P C01

CROSS-REFERENCE INDEXES

CAGEC	PART NUMBER	PART NUMBER INDEX STOCK NUMBER	FIG.	ITEM
			15	3
96906	MS25036-157	5940-00-143-4777	47	5
96906	MS25036-158	5940-00-682-2445	19	5
			15	2
			16	9
96906	MS27148-2	5999-00-057-2929	19	8
			51	15
96906	MS27183-10	5310-00-809-4058	8	3
			37	3
			50	24
			53	14
			54	12
			55	9
96906	MS3452W20-29S	5935-01-211-4440	5	34
96906	MS3456W20-29P	5935-01-075-9503	13	2
96906	MS35190-289	5305-00-958-5246	34	3
96906	MS35206-231	5305-00-889-3001	5	26
			7	5
96906	MS35206-264	5305-00-984-6211	5	17
96906	MS35206-280	5305-01-159-8544	27	2
			25	3
96906	MS35206-285	5305-00-988-1171	50	23
96906	MS35295-60	5306-01-084-5390	10	24
96906	MS35307-340	5306-00-816-5272	38	1
96906	MS35338-138	5310-01-420-7626	39	3
			36	4
96906	MS35338-44	5310-00-582-5965	8	19
			37	2
			50	17
96906	MS35387-1	9905-00-205-2795	10	19
			25	4
96906	MS35387-2	9905-00-282-3639	27	1
96906	MS45904-60	5310-01-080-9786	5	16
96906	MS45904-76	5310-00-061-1258	10	23
96906	MS51105-367	5305-01-118-8860	34	28
96906	MS51488-2	5305-01-306-3507	50	18
96906	MS51520A8S	4730-00-266-6772	36	3
96906	MS51525A12-16	4730-00-173-1881	33	8
96906	MS51527A12	4730-01-011-7736	33	6
96906	MS51844-43	4030-01-258-0467	29	34
			52	3
			56	7
			58	36
			59	26
			59	53
96906	MS51849-74	5305-00-470-3321	34	9
			7	3
96906	MS51922-9	5310-00-984-3806	26	6
96906	MS51943-31	5310-00-061-4650	26	11
96906	MS51958-64	5305-00-059-3660	9	7
			10	14

CROSS-REFERENCE INDEXES

CAGEC	PART NUMBER	PART NUMBER INDEX STOCK NUMBER	FIG.	ITEM
			51	6
			51	31
81349	M12133/1-12P	5310-01-038-2294	29	41
90202	M885AG	4030-00-278-0715	22	4
08162	N08	5310-00-185-6389	21	11
2K272	N09	5310-01-459-6206	21	14
37581	NICOPRESS18-1C	4030-01-315-7354	57	14
			59	5
			59	14
			59	20
			59	31
			59	38
			59	42
			59	48
79136	N5000-268	5325-00-722-8570	57	10
70485	OR150	5330-01-463-1206	54	14
99752	PLV-255B (PRESET	4820-01-373-5688	63	5
77060	R-64932		BULK	4
56501	SCH-1022	5975-01-207-0230	5	29
			7	11
0FHH8	SK3-0002N-1	5330-01-357-7904	KITS	
			KITS	
0FHH8	SK3-0017N-1	5330-01-357-7511	KITS	
0FHH8	SK3-0024N-1	5330-01-357-7512	KITS	
0FHH8	SK3-0035N-1	5330-01-357-7903	KITS	
0FHH8	SK3-0039N-1	5330-01-357-7510	KITS	
0FHH8	SK3-0088N-1	5330-01-355-9248	KITS	
07707	SSD44-SSBS	5320-00-173-8625	61	6
58723	S-1733-1500	5930-00-292-0520	17	6
84971	TA720S24	5340-00-224-1204	35	11
			58	8
84971	TA720-S8	5340-01-204-4888	29	39
01276	TCM20-1/2UNF-V	4730-01-372-9701	63	10
65059	T15094A-100		59	67
65059	T15096-100		59	64
82458	T892R		51	26
			53	25
82458	T893R	5310-01-288-1116	34	23
			26	7
52167	WC0412PB	5306-01-287-5714	34	15
			35	8
52167	WC0414PB	5306-01-287-5715	34	30
			26	8
			51	23
52167	WE0628TB	5305-01-341-3090	23	6
52167	WE0630TB	5305-01-156-5445	24	12
52167	WE0816TB		29	52
			57	26
52167	WE0818TB	5306-01-106-7496	23	2
52167	WE0820TB	5306-01-156-5429	29	49
			58	13

SECTION IV

TM 9-2320-304-14&P C01

CROSS-REFERENCE INDEXES

CAGEC	PART NUMBER	PART NUMBER INDEX STOCK NUMBER	FIG.	ITEM
52167	WE1030TB	5305-01-196-8088	22	11
2K272	W08	5310-01-355-8794	21	10
2K272	W09	5310-01-459-6126	21	13
2K272	W12	5310-01-458-0248	29	18
11139	W4S		50	11
52090	XS1M18PA370TF	5930-01-464-9574	8	21
			8	21
			8	17
			8	17
52090	XS1M30PA370TF	5930-01-464-9581	4	1
74687	028-561	5340-01-092-1637	26	12
80535	031-0424	4010-01-237-7544	BULK	1
53867	0332207402		50	2
45152	03373285		61	9
13548	07195		51	2
			51	28
13548	07197		51	3
			51	33
13548	07198		51	7
			51	29
19207	10892331	5310-00-880-6260	29	15
			24	18
45152	110310A	5310-01-159-8178	24	10
			23	7
			22	3
			56	3
			58	3
45152	110311A	5310-01-111-6450	29	47
			23	4
			57	1
			58	1
			58	18
45152	110312A	5310-01-150-5918	29	30
			22	6
			56	14
			57	5
			52	24
			60	1
4512	111315A	5305-01-155-4357	58	22
45152	111317A	5305-01-147-9723	58	26
45152	111319A	5305-01-196-0800	56	13
45152	111320A	5305-01-149-1934	22	10
45152	111452A	5306-01-159-6549	29	44
11139	114017	5935-01-174-1235	5	33
			5	22
			7	9
			50	12
45152	115293A	5305-01-150-7736	56	2
			58	14
45152	115304A	5306-01-155-9765	55	15
45152	115306A	5305-01-165-3297	54	1

CROSS-REFERENCE INDEXES

CAGEC	PART NUMBER	PART NUMBER INDEX STOCK NUMBER	FIG.	ITEM
45152	115307A	5310-01-151-1036	53	28
			57	21
77060	12010293	5975-01-226-8078	44	7
77060	12010300	5975-01-339-9574	16	6
			44	10
77060	12015193	5975-01-333-5974	16	4
77060	12015323	5975-01-310-5011	1	7
			12	4
77060	12015799	5935-01-213-1826	1	2
			12	3
77060	12034051	5940-01-342-0712	1	11
			12	5
77060	12048159	5940-01-462-1717	44	6
45152	120622A	5306-01-150-7726	29	45
			58	20
45152	120699A	5305-01-242-0655	57	3
77060	12077411	5940-01-353-3175	44	9
77060	12089040	5940-01-234-7272	1	6
77060	12089305	5999-01-319-7394	16	5
45152	121782A		BULK	3
45152	121782A-003		1	5
45152	121782A-004		1	8
45152	121782A-005		1	9
45152	121782A-006		1	3
45152	121782A-007		1	4
45152	126536A	5305-01-185-8668	22	9
45152	128131A	5305-01-167-9408	22	1
45152	1307840	5360-01-236-2072	23	9
45152	1312410	2540-01-134-3714	25	7
45152	1317120	5305-01-154-4323	22	12
			56	12
			59	11
			60	3
45152	1320590	9905-01-157-1026	28	6
97403	13207E6498-2	5935-00-691-5591	18	5
			19	6
			47	6
45152	1321570		55	11
45152	1321600	2540-01-131-6242	24	19
45152	1324510	5305-01-157-5624	24	7
45152	1324980	5305-01-155-3478	29	31
			22	13
			58	5
45152	1330560	5340-01-153-0313	24	2
45152	1333510	5310-01-340-5671	35	7
			24	20
			58	9
			61	11
45152	1336700	5306-01-236-1585	55	5
			56	11
			57	22

SECTION IV

TM 9-2320-304-14&P C01

CROSS-REFERENCE INDEXES

CAGEC	PART NUMBER	PART NUMBER INDEX STOCK NUMBER	FIG.	ITEM
45152	1337430	5305-01-152-4223	60	8
45152	1337630	5305-01-203-8360	37	1
45152	1337720	5305-01-156-5440	56	15
			58	21
			58	25
			60	2
45152	1367HX1	5305-01-062-1017	34	8
			26	3
45152	1379HX	5310-01-361-8388	3	4
45152	1381HX1	5305-01-134-2052	28	4
45152	1394510-012		29	7
45152	1394510-018		29	20
15235	141	5310-01-119-1811	5	27
			7	15
45152	1434HX	5305-01-155-5237	10	18
45152	1437220	5310-01-288-1116	24	15
45152	1456530		43	6
645152	1500280	2540-01-222-9653	25	2
3899	150234B	3040-01-374-4803	30	1
63899	150235B	3040-01-356-2707	40	1
61349	151467-P540	6685-01-368-7134	63	2
64678	15300002	5935-01-339-3227	44	4
77060	15300014	5940-01-462-1718	44	5
			44	12
77060	15300027	4935-01-308-7866	44	8
			44	11
45152	1533100		BULK	2
45152	1533100-10		57	15
45152	1533100-012		59	58
45152	1533100-013		59	29
45152	1533100-015		58	6
			59	22
			59	36
45152	1533100-018		59	49
45152	1533100-021		59	44
45152	1533100-022		29	35
			59	13
45152	1533100-026		59	24
45152	1533100-32		51	4
45152	1533100-40		56	6
45152	1533100-52		58	35
45152	1556620		58	4
45152	1560090	5961-01-318-9764	5	23
78519	1571850	5310-01-288-5096	5	11
			34	10
			10	7
			51	10
			51	36
45152	1571850	5310-01-288-5096	50	22
45152	1571870	5310-01-352-7732	5	36
			7	14

CROSS-REFERENCE INDEXES

CAGEC	PART NUMBER	PART NUMBER INDEX STOCK NUMBER	FIG.	ITEM
45152	1598030	5310-01-342-8595	29	17
			58	17
76374	1600-206-10032	5935-01-344-4901	2	5
45152	1600460	5310-01-346-9445	34	20
			34	4
			10	26
			10	21
			17	7
			24	14
			25	5
45152	1606140	5305-01-344-8899	34	19
			10	3
			24	4
			57	17
81343	16-16 080320CA	4730-00-177-5894	43	3
45152	1624120	5999-01-355-6670	12	7
42366	16282B-35005	5342-01-384-9511	10	20
			51	17
			51	38
06721	1737095	4730-01-450-5139	58	31
			59	71
45152	1749HX	5315-01-459-7340	53	20
			59	56
98343	175220-60	4010-01-348-6039	KITS	
45152	1754310		53	24
45152	1754140	5305-01-337-9120	10	28
			34	21
			17	10
45152	1754210	5305-01-340-0225	35	10
			58	7
45152	1754220	5305-01-353-8267	24	1
			59	52
			61	8
45152	1754280	5305-01-340-5061	34	24
45152	1754300	5305-01-353-8268	24	5
45152	1754310	5305-01-357-4682	53	24
45152	1756870	5306-01-341-0712	35	5
45152	1772HX2	5305-01-236-5107	58	29
45152	1778690W	5340-01-354-0175	26	10
45152	1779770	5340-01-363-6141	35	6
45152	1781440	5305-01-341-3090	58	27
45152	1783090	2510-01-357-8795	24	6
45152	1783100	2510-01-357-8796	24	6
45152	1783110	2510-01-357-2507	24	13
45152	1783190	9905-01-361-8611	28	8
			61	16
45152	1785220	9905-01-358-6746	28	14
45152	1804HX	5310-01-061-7452	42	3
			38	3
45152	1833HX1		55	4
45152	1840070		55	3

CROSS-REFERENCE INDEXES

CAGEC	PART NUMBER	PART NUMBER INDEX STOCK NUMBER	FIG.	ITEM
45152	1846HX1	5305-01-344-5532	42	1
45152	1849HX1	5306-01-164-7437	38	10
45152	1860250W	2530-01-356-4614	29	22
45152	1860310W	2530-01-356-4613	29	25
			53	9
45152	1860780	6150-01-362-5227	14	1
45152	1860790	6150-01-362-5228	13	1
45152	1860800	6150-01-362-5215	11	1
45152	1860810	6150-01-362-6365	12	1
45152	1860820	6150-01-362-5216	20	1
45152	1861940	2590-01-414-3179	29	2
45152	1861950	2540-01-358-1218	29	1
45152	1862230W	3910-01-397-5277	21	15
45152	1862320	5325-01-462-7182	57	8
45152	1862340	3120-01-355-8843	21	12
45152	1862350	5340-01-355-3794	21	3
45152	1862360	5340-01-355-5248	21	4
45152	1862510W	5340-01-355-5259	34	31
45152	1862530W	5340-01-355-5268	34	11
45152	1862570	4710-01-358-6946	38	8
45152	1862580	4710-01-360-2293	38	7
45152	1862590	4710-01-360-9502	38	14
45152	1862600	4710-01-361-3985	38	6
45152	1862610	4710-01-356-7535	37	7
45152	1862620	4710-01-360-2292	37	6
45152	1862640	5340-01-355-3713	34	1
45152	1862690W	3040-01-356-6837	29	28
45152	1862720W	5315-01-361-2721	29	6
45152	1862770	5340-01-356-8373	29	11
45152	1862820	5365-01-355-7357	29	26
			53	10
45152	1862830	5365-01-355-7358	29	23
45152	1863010W	3040-01-356-4589	29	16
45152	1867670	5340-01-358-6695	10	22
45152	1869500	5945-01-351-4593	5	15
45152	1877440	6150-01-362-6367	6	25
45152	1877450	6150-01-362-5221	6	21
45152	1877460	6150-01-362-5222	6	9
45152	1877470	6150-01-362-5223	6	17
45152	1877480	6150-01-362-5224	6	13
45152	1877490	6150-01-362-5225	6	5
45152	1878900	6150-01-363-2162	8	6
45152	1878910	6150-01-362-5218	8	12
45152	1883410	5975-01-413-6387	5	10
45152	1883440	6150-01-362-5219	5	30
45152	1883450	6150-01-362-5220	5	19
45152	1891360U	5930-01-372-9489	1	1
45152	1891380	4730-01-356-1018	42	10
45152	1891390	4730-01-355-5140	31	1
45152	1891410	6150-01-362-5217	7	6
45152	1891540	5940-01-358-1127	7	1

CROSS-REFERENCE INDEXES

		PART NUMBER INDEX		
CAGEC	PART NUMBER	STOCK NUMBER	FIG.	ITEM
45152	1897980	5340-01-355-9368	29	12
45152	1920730	9905-01-358-4270	28	13
45152	1921380	2510-01-357-5691	24	16
45152	1923570	4710-01-356-8755	33	3
45152	1923580	4710-01-356-8756	33	2
45152	1937190	5340-01-356-8487	24	11
45152	1937550	5310-01-355-8798	31	20
			41	15
45152	1944310	6150-01-362-5226	6	1
45152	1948290	9905-01-358-7089	28	12
45152	1949110	6150-01-362-5240	5	1
45152	1953740	5340-01-363-6139	21	6
45152	1955680	5930-01-355-7119	5	4
45152	1956170	5315-01-363-6984	29	36
45152	1965220	5315-01-363-7062	29	37
			59	73
45152	1971460W	5670-01-408-8386	23	1
45152	1976560	5340-01-364-4343	24	3
45152	1976570	5340-01-364-1959	24	3
45152	1987130		28	9
45152	1997520W	5935-01-376-1003	8	4
45152	2CH281	5305-01-359-7965	53	12
			50	21
K0274	200-116-4490		39	2
			38	12
K0274	200-214-4490	5331-01-168-8112	36	2
			42	8
45152	2008530-006		59	72
K0274	200-912-4490	5331-00-395-5737	42	9
45152	2013HX1	5305-01-061-7910	29	13
00624	202702-12-8S	4730-00-925-8039	41	3
01276	202702-16-8S	4730-01-160-6708	63	11
01276	202702-8-8S	4730-00-853-1182	31	18
01276	2027-8-8S	4730-01-242-2840	63	8
01276	2043-16-16S	4730-01-327-7081	33	1
45152	2048840W	5340-01-394-2420	34	14
45152	2048850W	5340-01-394-2421	34	25
01276	206209-12-12S	4730-01-355-9003	33	10
01276	206209-8-8S	4730-01-242-1290	33	12
45152	2063940	5365-01-394-3553	34	5
45152	2068380	2510-01-364-4489	24	17
45152	2083HX	5310-01-214-4946	29	42
72962	21NE-040	5310-01-066-6759	10	6
			8	5
			50	26
01276	210292-8S	5310-01-006-5018	63	12
45152	2150HX1	5310-01-141-5565	38	9
45152	2152010	5315-01-462-2073	62	2
45152	2152250	5315-01-459-7337	59	57
45152	2172040X1		59	21
45152	2172170W	5340-01-462-3362	59	8

SECTION IV

TM 9-2320-304-14&P C01

CROSS-REFERENCE INDEXES

CAGEC	PART NUMBER	PART NUMBER INDEX STOCK NUMBER	FIG.	ITEM
45152	2172220W	2510-01-429-9684	59	1
45152	2172250		59	2
45152	2172260XA		59	4
45152	2172260	5315-01-431-9369	59	3
			59	18
45152	2173040XA		57	13
45152	2173040	5315-01-429-6971	57	12
			58	40
			59	27
45152	2176240XA		59	12
45152	2176240	5315-01-429-7296	59	11
451552	2176250W	5340-01-458-6165	59	55
45152	2176430XA		59	15
45152	2176430		59	14
45152	2176780		55	14
53790	2180PA	5340-01-355-8246	8	1
45152	2196790	5350-01-431-5149	53	4
72962	22NM04	5310-00-207-9341	3	5
45152	2207830XA		59	47
			59	50
05FJ2	2207830	5315-01-431-0602	59	46
01276	221501-16-12S	4730-01-462-2632	43	5
45152	2221970	5365-01-459-8230	48	1
45152	2232480		59	60
45152	2235270W	5340-01-462-3363	59	61
45152	2235280	5305-01-458-6171	59	62
45152	2242310W	2510-01-462-4681	59	74
45152	2253880	5310-01-462-6502	53	16
45152	2254220	5310-01-462-6513	54	3
45152	2255150		56	8
45152	2255160		56	19
45152	2258840	3120-01-462-1442	54	4
01276	22617-12	5331-00-228-7196	33	11
			33	7
			43	6
			33	9
			41	4
01276	22617-16	5330-01-168-0885	33	17
01276	22617-8	5330-01-244-2273	33	13
			33	5
			43	4
			42	5
			31	19
45152	2265340	5340-01-462-3360	48	4
45152	2270080W		51	16
45152	2270090W		51	17
45152	2282360-28		58	32
45152	2302HX	5310-01-353-6045	56	5
93907	234 86500-382	5305-01-274-0028	56	4
70485	2406	5325-00-022-6273	51	25

CROSS-REFERENCE INDEXES

CAGEC	PART NUMBER	PART NUMBER INDEX STOCK NUMBER	FIG.	ITEM
01276	2266-16-16S	4730-01-241-4650	33	16
35510	2434	5310-00-775-5139	7	2
06853	244095	5310-01-105-7229	59	59
10001	2533408-26	5310-01-343-5712	29	40
64386	277-A-80-1	5340-01-156-6776	26	5
12603	2775859	5935-01-319-5222	1	10
			12	6
			16	3
96652	28-04	5315-01-355-3744	29	21
96652	28-06	5315-01-459-1409	53	2
96652	28-07	5315-01-358-3736	58	37
			59	7
			59	15
			59	19
			59	25
			59	37
24617	2965639	5940-00-399-6676	17	5
77060	297002	5975-01-148-4607	17	4
45152	3SK804	3990-01-358-1146	21	5
45152	3SK805	3990-01-357-1944	21	9
06090	301A022-4/42	5970-01-358-3441	8	10
			8	14
45152	3017871		5	2
45152	3017872		5	2
45152	3017873		5	5
45152	3017874		5	12
45152	3017875		5	7
45152	3017876		5	7
45152	3017877		5	7
13548	30250Y	5980-01-459-2073	9	2
			10	13
			51	5
			51	30
45152	3051121	2510-01-453-8548	29	29
45152	3051989		22	8
45152	3051990		22	8
45152	3053453		22	2
45152	3053657		34	22
45152	3053658		34	26
45152	3053774		29	46
45152	3053775		29	46
45152	3053776		29	48
45152	3053777		29	51
45152	3053912		22	14
45152	3053913		29	31
45152	3054536		23	5
45152	3054537		23	3
45152	3055018		3	2
45152	3055128		22	15
45152	3055129		29	32
45152	3055130		18	1

SECTION IV

TM 9-2320-304-14&P C01

CROSS-REFERENCE INDEXES

CAGEC	PART NUMBER	PART NUMBER INDEX STOCK NUMBER	FIG.	ITEM
45152	3055132		29	38
45152	3055925		22	7
45152	3056237		43	7
45152	3056238		35	13
45152	3056239		35	14
45152	3056240		35	3
45152	3056241		35	16
			63	7
45152	3056242		35	1
45152	3056243		35	15
45152	3056244		35	4
45152	3056245		35	2
45152	3056872	2510-01-457-5270	29	53
45152	3057867		35	9
45152	3060685		15	1
45152	3060686		16	1
45152	3061973		17	1
45152	3064067		28	5
45152	3064068		28	7
45152	3064801	5305-01-459-3059	31	21
			41	14
45152	3117420	5340-01-462-3367	56	9
1DK67	3117421		61	13
45152	3117428	5340-01-462-6637	53	3
45152	3117429	5340-01-462-6645	53	3
45152	3117461		59	33
45152	3117462		59	17
45152	3117463	2510-01-461-2924	59	63
45152	3117504	5315-01-462-5888	53	21
45152	3117505	5315-01-462-5890	53	22
45152	3117507	5360-01-462-8548	53	23
45152	3117546		54	16
45152	3117567	5310-01-462-5971	53	19
45152	3119744		54	8
45152	3119747	2510-01-462-4688	59	23
45152	3121846	5340-01-462-6628	54	5
45152	3121847	5340-01-462-6483	54	5
45152	3121863	3040-01-462-5032	53	29
45152	3121879	2510-01-462-4677	57	11
45152	3121881	3030-01-462-5029	57	19
45152	3121882	2510-01-462-4683	55	12
45152	3122223	5340-01-462-6138	48	3
45152	2122230	5340-01-462-5711	59	16
45152	3122231	5340-01-462-5709	59	32
45152	3123917	5340-01-462-5704	53	1
45152	3123918	5340-01-462-5703	53	1
45152	3123921XA		59	43
45152	3123921	5315-01-463-0139	59	40
45152	3124495	5315-01-480-7516	58	34
45152	3124496	3120-01-461-8639	59	10
45152	3124572	5310-01-462-6509	54	9

CROSS-REFERENCE INDEXES

CAGEC	PART NUMBER	PART NUMBER INDEX STOCK NUMBER	FIG.	ITEM
45152	3124573	5340-01-462-5702	56	16
45152	3124574	5340-01-462-5443	56	20
45152	3126499	5360-01-462-7636	53	7
45152	3126523	9905-01-459-4979	28	1
45152	3126527		55	1
45152	3126528		55	1
45152	3127711	2530-01-462-0714	55	13
			57	9
45152	3127712	4710-01-462-1238	55	2
45152	3127723	5315-01-462-5964	55	7
			54	16
45152	3128999	5315-01-462-7513	53	8
45152	3129006	5315-01-462-7515	53	5
45152	3135770	6150-01-461-9229	45	1
45152	3135832	5930-01-462-2954	48	2
			49	1
45152	3135833		50	15
45152	3138310	5340-01-462-1761	56	10
45152	3143298		58	43
45152	3143309	2590-01-462-5751	58	44
45152	3145738		57	25
45152	3149277		51	24
45152	3150265		51	24
1DK67	3152159	9905-01-463-1432	61	5
1DK67	3152161	'	61	12
1DK67	3152164		61	2
1DK67	3152167		61	3
1DK67	3152168		61	14
1DK67	3152169		61	10
1DK67	3152174		61	15
45152	3153166		10	1
45152	3154864		10	2
45152	3181842	6150-01-461-9183	44	1
45152	3188476		52	1
45152	3188569		59	9
53790	3190/190-PA	5340-01-355-3733	38	5
45152	2191030	5340-01-462-1757	59	45
45152	3122798	5340-01-462-1762	56	1
45152	3192799	5340-01-462-3365	56	1
45152	3217276		58	19
45152	3217374		50	25
45152	3217375		57	2
45152	3217377		51	39
45152	3217508		59	39
45152	3218659		54	15
45152	3218660		54	15
45152	3227120		62	3
45152	3227252		55	6
			57	20
45152	3234880		58	42
45152	3252505		59	51

SECTION IV

TM 9-2320-304-14&P C01

CROSS-REFERENCE INDEXES

CAGEC	PART NUMBER	PART NUMBER INDEX STOCK NUMBER	FIG.	ITEM
53790	3254PA	5340-01-355-8247	37	5
45152	3263040		25	1
00779	327025	5940-01-368-9579	17	8
45152	3276347		19	1
45152	3285659		28	10
45152	3285672		28	3
53867	3-334-485-008	5935-01-208-3507	5	14
72447	330734	5310-01-216-2799	29	9
45152	3340898		60	7
53867	3334485045		50	5
45152	3335176		56	18
45152	3335177		56	17
45152	3344561		58	10
45152	3344562		58	12
45152	3345899		58	33
45152	3346009		58	38
45152	3346010		58	41
45152	3346716		58	6
45152	3347761		58	39
45152	3348988		51	27
45152	3349083		51	11
45152	3349084		51	1
45152	3349085		51	2
45152	3349086		47	1
45152	3349157		60	5
45152	3353059		50	1
45152	3353061		49	3
45152	3353063		49	2
45152	3353065		57	23
45152	3353066		50	16
45152	3353067		46	1
45152	3353069		50	4
45151	3353147		57	4
45152	3353148		57	4
45152	3355525		58	24
45152	3357080		58	16
45152	3357391		58	15
45152	3359616		58	2
45152	3367305		61	7
45152	3389198		50	20
00779	341002-6	5940-01-288-4774	16	2
45152	351AX	5310-01-129-0450	34	13
			10	5
			29	14
			51	18
			51	20
			51	40
45152	354AX	5310-01-068-8446	21	2
			34	7
			38	2
45152	355AX	5310-01-133-2130	21	8

SECTION IV

TM 9-2320-304-14&P C01

CROSS-REFERENCE INDEXES

CAGEC	PART NUMBER	PART NUMBER INDEX STOCK NUMBER	FIG.	ITEM
45152	362AX	5310-01-062-3379	34	27
			53	18
			55	10
45152	3737FX3	5342-01-175-0316	34	17
45152	4SK777		63	1
00779	41274	5940-00-874-9033	5	32
			5	20
			6	26
			6	22
			6	10
			6	18
			6	14
			6	6
			5	3
			5	6
			6	2
			5	13
			5	8
			7	7
8	7			
00779	42282-2	5940-00-620-9780	8	11
			8	13
			5	31
63899	430457B	5330-01-394-3549	5	9
			16	8
45152	434-A	5310-01-063-8970	KITS	
17566	45A115-P29	5305-01-166-4410	10	4
			51	19
			51	21
45152	45092AX	5305-01-064-5470	51	41
63899	500419B	5365-01-355-9965	5	24
			8	20
45152	50619AX	5305-01-355-1428	40	4
			30	4
79136	5100-315	5325-00-282-7149	34	29
78189	511-041810-01	5310-00-542-0087	29	27
			53	2
56501	5262	5330-00-588-0892	5	18
			7	13
13548	5370		5	28
			7	10
			9	5
45152	53925AX	5310-01-166-1708	10	16
			51	8
			51	34
79470	5515X8	4730-00-917-4794	60	4
70485	559	5325-00-925-9838	33	4
19204	572929	5999-00-057-2929	10	25
			18	7
82484	59L.257	6220-01-369-9851	47	8
			2	4

SECTION IV

TM 9-2320-304-14&P C01

CROSS-REFERENCE INDEXES

CAGEC	PART NUMBER	PART NUMBER INDEX STOCK NUMBER	FIG.	ITEM
82484	59L.258	6220-01-369-9849	2	3
82484	59L.261	6220-01-369-9852	2	6
45152	59030AX	5305-00-984-6210	50	3
45152	59031AX	5305-01-249-8564	10	17
			26	1
			3	1
			51	9
			51	35
82484	596 620	7690-01-292-9726	2	7
11139	5962-202-16141	5999-01-372-4955	50	9
45152	60253-2	5940-01-353-6476	50	7
45152	60435-1		50	6
45152	615FX	4730-01-217-1115	29	5
96652	63-02	5315-01-215-7505	58	30
45152	66420AX	5305-01-280-7901	8	2
			55	8
64386	67D794	2540-01-152-7764	26	2
57013	688411-4	6350-01-319-9161	17	9
63899	700079A	3040-01-373-0500	40	14
			30	12
63899	701121A		40	6
			30	6
63899	702001A		40	5
			30	5
63899	703425A		40	8
			30	8
63899	704425A		40	9
			30	9
63899	706069A		40	7
			30	7
19207	7064586	5935-00-677-4444	17	3
63899	711009A	5305-01-355-2643	40	2
			30	2
63899	711053A	5305-01-355-2641	40	3
			30	3
63899	711083A	5305-01-355-2642	40	12
			30	14
63899	715001A	5340-01-372-3982	40	11
			30	13
13548	7195		10	10
13548	7196		9	1
13548	7197		9	4
			10	11
13548	7198		9	6
			10	15
45152	720HX	5310-01-457-8573	23	8
			58	28
63899	721175A		40	10
			30	10
63899	721176A		40	13
			30	11

CROSS-REFERENCE INDEXES

CAGEC	PART NUMBER	PART NUMBER INDEX STOCK NUMBER	FIG.	ITEM
0D5M6	731740-002	5330-01-355-4809	6	27
			6	23
			6	11
			6	19
			6	15
			6	7
			6	3
			8	9
			8	16
45152	736HX1	5305-01-296-0341	34	12
45152	738HX4	5305-01-328-4384	21	7
57733	752023	5340-01-168-7285	34	2
81343	8-8 070120CA	4730-01-156-4835	42	4
0FHH8	8F3930	4820-01-356-6765	41	5
0FHH8	8F 3931	4730-01-356-9875	32	1
0FHH8	8H38529/53	5340-01-389-3537	32	18
			32	35
			31	14
01212	800850	5330-01-463-1208	54	2
01212	80X100X10	5330-01-355-9269	29	3
			53	27
01212	801000	5330-01-463-1204	54	6
0FHH8	801001M	5340-01-389-3462	32	10
			31	15
0FHH8	801003M	4730-01-355-9043	32	8
0FHH8	801004M	5365-01-355-5141	32	2
			41	11
0FHH8	801005M	5365-01-361-5599	32	6
0FHH8	801006M	5365-01-355-5142	32	4
0FHH8	8022N7011		41	10
0FHH8	8022N7014		32	22
0FHH8	8022N7017		31	7
0FHH8	8022N7019		32	24
0FHH8	8022N7020		32	27
0FHH8	8023N7009		32	33
			32	43
			31	10
0FHH8	8023N7011	5331-01-460-9149	32	30
			32	38
0FHH8	8023N7013	5331-01-355-9911	31	17
			41	6
0FHH8	8023N7015		31	5
0FHH8	8023N7017		32	14
0FHH8	8023N7018		32	16
0FHH8	8024N902		32	11
			31	16
0FHH8	8024N904	5331-01-457-3314	32	9
0FHH8	8024N905		32	3
			41	12
0FHH8	8024N906	5331-01-460-9137	32	7
0FHH8	8024N908	5331-01-457-1834	32	5

SECTION IV

TM 9-2320-304-14&P C01

CROSS-REFERENCE INDEXES

CAGEC	PART NUMBER	PART NUMBER INDEX STOCK NUMBER	FIG.	ITEM
			32	37
			32	41
			31	11
			41	8
0FHH8	8024N910		32	20
0FHH8	8024N912		31	3
0FHH8	8024N914		32	13
0FHH8	8024N916		32	28
0FHH8	8025N9011		41	9
0FHH8	8025N9013		32	21
0FHH8	8025N9015		31	6
0FHH8	8025N9016		31	4
0FHH8	8025N9017		32	17
0FHH8	8025N9018		32	15
0FHH8	8025N9019		32	25
0FHH8	8025N9020		32	26
0FHH8	804902B1W	5305-01-355-1355	32	31
65059	806PX12		59	69
65059	806PX15		59	68
65059	8061508		59	70
35111	811	4030-01-456-1150	29	8
19207	8338562	5970-00-833-8562	18	3
			19	3
			47	3
19207	8338564	5940-00-399-6676	18	2
			19	2
			47	2
19207	8338567	5310-00-833-8567	18	6
			19	7
			47	7
			51	14
80372	87024A0521	5340-01-375-6932	59	66
80372	87024A0522	9330-01-375-9240	59	65
19207	8724494	5975-00-660-5962	18	4
			19	4
			47	4
19207	8724495	5935-00-691-5591	51	13
45152	8865GX	5310-01-061-5301	29	50
0FHH8	9DD000140	4820-01-356-2638	41	13
0FHH8	9DD000239	4810-01-373-7257	32	32
0FHH8	9DD000240	4810-01-356-4487	32	29
0FHH8	9DD000241	5305-01-355-1360	32	34
0FHH8	9DD000255	5930-01-355-7099	32	36
0FHH8	9P000202	4820-01-355-8980	31	12
0FHH8	9S000104	5330-01-363-0667	KITS	
0FHH8	9S000105	5330-01-393-5075	KITS	
0FHH8	9S000106	5330-01-372-8377	KITS	
51917	9003-KAE1B	5930-01-355-7309	1	13
51918	9003-K2M0083US	5930-01-355-7110	1	12
0FHH8	900565-012		32	42
			31	9

SECTION IV

TM 9-2320-304-14&P C01

CROSS-REFERENCE INDEXES

CAGEC	PART NUMBER	PART NUMBER INDEX STOCK NUMBER	FIG.	ITEM
01276	900599-8S	4730-01-316-9239	63	9
82484	913328	5935-01-351-4732	16	7
0D5M6	931236-100	5935-01-355-7505	6	28
			6	24
			6	12
			6	20
			6	16
			6	8
			6	4
			8	8
			8	15
11939	93544216	5305-01-082-0049	21	1
11939	93613642	5310-01-068-8446	42	2
13548	94626	6150-01-459-1811	9	3
			10	12
			51	4
			51	32

CROSS-REFERENCE INDEXES

FIG.	ITEM	FIGURE AND ITEM NUMBER INDEX STOCK NUMBER	CAGEC	PART NUMBER
1	1	5930-01-372-9489	45152	1891360U
1	2	5935-01-213-1826	77060	12015799
1	3		45152	121782A-006
1	4		45152	121782A-007
1	5		45152	121782A-003
1	6	5940-01-234-7272	77060	12089040
1	7	5975-01-310-5011	77060	12015323
1	8		45152	121782A-004
1	9		45152	121782A-005
1	10	5935-01-319-5222	12603	2775859
1	11	5940-01-342-0712	77060	1203 4051
1	12	5930-01-355-7110	51918	9003-K2M0083US
1	13	5930-01-355-7309	51917	9003-KAE1B
2	1	6240-01-365-7995	82484	E-013-004
2	2	6220-01-354-7462	82484	E-131-001
2	3	6220-01-369-9849	82484	59L.258
2	4	6220-01-369-9851	82484	59L.257
2	5	5935-01-344-4901	76374	1600-206-10032
2	6	6220-01-369-9852	82484	59L.261
2	7	7690-01-292-9726	82484	596 620
2	8	6240-01-358-7127	82484	E-013-003
3	1	5305-01-249-8564	45152	59031AX
3	2		45152	3055018
3	3	6110-01-358-9389	0NYH2	D-191-7-1
3	4	5310-01-361-8388	45152	1379HX
3	5	5310-00-207-9341	72962	22NM04
4	1	5930-01-464-9581	52090	XS1M30PA370TF
4	2	5935-01-357-1036	71468	CA3101F10SL-3PF8
5	1	6150-01-362-5240	45152	1949110
5	2		45152	3017871
5	2		45152	3017872
5	3	5940-00-874-9033	00779	41274
5	4	5930-01-355-7119	45152	1955680
5	5		45152	3017873
5	6	5940-00-874-9033	00779	41274
5	7		45152	3017875
5	7		45152	3017876
5	7		45152	3017877
5	8	5940-00-874-9033	00779	41274
5	9	5940-00-620-9780	00779	42282-2
5	10	5975-01-413-6387	45152	1883410
5	11	5310-01-288-5096	78519	1571850
5	12		45152	3017874
5	13	5940-00-874-9033	00779	41274
5	14	5935-01-208-3507	53867	3-334-485-008
5	15	5945-01-351-4593	45152	1869500
5	16	5310-01-080-9786	96906	MS45904-60
5	17	5305-00-984-6211	96906	MS35206-264
5	18	5310-00-542-0087	78189	511-041810-01
5	19	6150-01-362-5220	45152	1883450

CROSS-REFERENCE INDEXES

FIG.	ITEM	FIGURE AND ITEM NUMBER INDEX		
		STOCK NUMBER	CAGEC	PART NUMBER
5	20	5940-00-874-9033	00779	41274
5	21	5935-01-317-6762	71468	CA3102R18-1S-F80
5	22	5935-01-174-1235	11139	114017
5	23	5961-01-318-9764	45152	1560090
5	24	5305-01-166-4410	17566	45A115-P29
5	25	5940-01-357-9200	71400	A 203118-NL
5	26	5305-00-889-3001	96906	MS35206-231
5	27	5310-01-119-1811	15235	141
5	28	5330-00-588-0892	56501	5262
5	29	5975-01-207-0230	56501	SCH-1022
5	30	6150-01-362-5219	45152	1883440
5	31	5940-00-620-9780	00779	42282-2
5	32	5940-00-874-9033	00779	41274
5	33	5935-01-174-1235	11139	114017
5	34	5935-01-211-4440	96906	MS3452W20-29S
5	35	5305-01-086-3551	45152	EE-105327
5	36	5310-01-352-7732	45152	1571870
6	1	6150-01-362-5226	45152	1944310
6	2	5940-00-874-9033	00779	41274
6	3	5330-01-355-4809	0D5M6	731740-002
6	4	5935-01-355-7505	0D5M6	931236-100
6	5	6150-01-362-5225	45152	1877490
6	6	5940-00-874-9033	00779	41274
6	7	5330-01-355-4809	0D5M6	731740-002
6	8	5935-01-355-7505	0D5M6	931236-100
6	9	6150-01-362-5222	45152	1877460
6	10	5940-00-874-9033	00779	41274
6	11	5330-01-355-4809	0D5M6	731740-002
6	12	5935-01-355-7505	0D5M6	931236-100
6	13	6150-01-362-5224	45152	1877480
6	14	5940-00-874-9033	00779	41274
6	15	5330-01-355-4809	0D5M6	731740-002
6	16	5935-01-355-7505	0D5M6	931236-100
6	17	6150-01-362-5223	45152	1877470
6	18	5940-00-874-9033	00779	41274
6	19	5330-01-355-4809	0D5M6	731740-002
6	20	5935-01-355-7505	0D5M6	931236-100
6	21	6150-01-362-5221	45152	1877450
6	22	5940-00-874-9033	00779	41274
6	23	5330-01-355-4809	0D5M6	731740-002
6	24	5935-01-355-7505	0D5M6	931236-100
6	25	6150-01-362-6367	45152	1877440
6	26	5940-00-874-9033	00779	41274
6	27	5330-01-355-4809	0D5M6	731740-002
6	28	5935-01-355-7505	0D5M6	931236-100
7	1	5940-01-358-1127	45152	1891540
7	2	5310-00-775-5139	35510	2434
7	3	5305-00-470-3321	96906	MS51849-74
7	4	5940-01-357-9199	71400	A203107-NL
7	5	5305-00-889-3001	96906	MS35206-231

CROSS-REFERENCE INDEXES

FIG.	ITEM	FIGURE AND ITEM NUMBER INDEX STOCK NUMBER	CAGEC	PART NUMBER
7	6	6150-01-362-5217	45152	1891410
7	7	5940-00-874-9033	00779	41274
7	8	5935-01-317-6762	71468	CA3102R18-1S-F80
7	9	5935-01-174-1235	11139	114017
7	10	5330-00-588-0892	56501	5262
7	11	5975-01-207-0230	81922	SHC-1022
7	12	5305-01-086-3551	45152	EE-105327
7	13	5310-00-542-0087	78189	511-041810-01
7	14	5310-01-352-7732	45152	1571870
7	15	5310-01-119-1811	15235	141
8	1	5340-01-355-8246	53790	2180PA
8	2	5305-01-280-7901	45152	66420AX
8	3	5310-00-809-4058	96906	MS27183-10
8	4	5935-01-376-1003	45152	1997520W
8	5	5310-01-066-6759	72962	21NE-040
8	6	6150-01-363-2162	45152	1878900
8	7	5940-00-874-9033	00779	41274
8	8	5935-01-355-7505	0D5M6	931236-100
8	9	5330-01-355-4809	0D5M6	731740-002
8	10	5970-01-358-3441	06090	301A022-4/42
8	11	5940-00-874-9033	00779	41274
8	12	6150-01-362-5218	45152	1878910
8	13	5940-00-874-9033	00779	41274
8	14	5970-01-358-3441	06090	301A022-4/42
8	15	5935-01-355-7505	0D5M6	931236-100
8	16	5330-01-355-4809	0D5M6	731740-002
8	17	5930-01-464-9574	52090	XS1M18PA370TF
8	18	5340-01-355-6821	53790	DP-2
8	19	5310-00-582-5965	96906	MS35338-44
8	20	5305-01-064-5470	45152	45092AX
8	21	5930-01-464-9574	52090	XS1M18PA370TF
9	1		13548	7196
9	2	5980-01-459-2073	13548	30250Y
9	3	6150-01-459-1811	13548	94626
9	4		13548	7197
9	5		13548	5370
9	6		13548	7198
9	7	5305-00-059-3660	96906	MS51958-64
9	8	5305-01-352-2066	93907	B71-10015-002
10	1		45152	3153166
10	2		45152	3154864
10	3	5305-01-344-8899	45152	1606140
10	4	5310-01-063-8970	45152	434-A
10	5	5310-01-129-0450	45152	351AX
10	6	5310-01-066-6759	72962	21NE-040
10	7	5310-01-288-5096	78519	1571850
10	8	5340-01-419-1315	83014	H360K2598
10	9	5340-01-224-8368	83014	H360-6-2
10	10		13548	7195
10	11		13548	7197

CROSS-REFERENCE INDEXES

FIG.	ITEM	FIGURE AND ITEM NUMBER INDEX		
		STOCK NUMBER	CAGEC	PART NUMBER
10	12	6150-01-459-1811	13548	94626
10	13	5980-01-459-2073	13548	30250Y
10	14	5305-00-059-3660	96906	MS51958-64
10	15		13548	7198
10	16		13548	5370
10	17	5305-01-249-8564	45152	59031AX
10	18	5305-01-155-5237	45152	1434HX
10	19	9905-00-205-2795	96906	MS35387-1
10	20	5342-01-384-9511	42366	16282B-35005
10	21	5310-01-346-9445	45152	1600460
10	22	5340-01-358-6695	45152	1867670
10	23	5310-00-061-1258	96906	MS45904-76
10	24	5306-01-084-5390	96906	MS35295-60
10	25	5325-00-925-9838	70485	559
10	26	5310-01-346-9445	45152	1600460
10	27		75272	COV-0713
10	28	5305-01-337-9120	45152	1754140
11	1	6150-01-362-5215	45152	1860800
11	2	5935-01-297-2794	71468	CA3106F20-29S-F8
12	1	6150-01-362-6365	45152	1860810
12	2	5935-01-408-2896	71468	CA3100R20-29PF80
12	3	5935-01-213-1826	77060	12015799
12	4	5975-01-310-5011	77060	12015323
12	5	5940-01-342-0712	77060	12034051
12	6	5935-01-319-5222	12603	2775859
12	7	5999-01-355-6670	45152	1624120
13	1	6150-01-362-5228	45152	1860790
13	2	5935-01-075-9503	96906	MS3456W20-29P
14	1	6150-01-362-5227	45152	1860780
14	2	5935-01-112-9782	71468	CA3106F18-1PF80
15	1		45152	3060685
15	2	5940-00-682-2445	96906	MS25036-158
15	3	5940-00-557-4345	96906	MS25036-118
16	1		45152	3060686
16	2	5940-01-288-4774	00779	341002-6
16	3	5935-01-319-5222	12603	2775859
16	4	5975-01-333-5974	77060	12015193
16	5	5999-01-319-7394	77060	12089305
16	6	5975-01-339-9574	77060	12010300
16	7	5935-01-351-4732	82484	913328
16	8	5940-00-620-9780	00779	42282-2
16	9	5940-00-682-2445	96906	MS25036-158
17	1		45152	3061973
17	2	5940-00-557-4345	96906	MS25036-118
17	3	5935-00-677-4444	19207	7064586
17	4	5975-01-148-4607	77060	297002
17	5	5940-00-399-6676	24617	2965639
17	6	5930-00-292-0520	58723	S-1733-1500
17	7	5310-01-344-8899	45152	1600460
17	8	5940-01-368-9579	00779	327025

CROSS-REFERENCE INDEXES

FIG.	ITEM	FIGURE AND ITEM NUMBER INDEX STOCK NUMBER	CAGEC	PART NUMBER
17	9	6350-01-319-9161	57013	688411-4
17	10	5305-01-337-9120	45152	1754140
18	1		45152	3055130
18	2	5940-00-399-6676	19207	8338564
18	3	5970-00-833-8562	19207	8338562
18	4	5975-00-660-5962	19207	8724494
18	5	5935-00-691-5591	97403	13207E6498-2
18	6	5310-00-833-8567	19207	8338567
18	7	5999-00-057-2929	19204	572929
19	1		45152	3276347
19	2	5940-00-399-6676	19207	8338564
19	3	5970-00-833-8562	19207	8338562
19	4	5975-00-660-5962	19207	8724494
19	5	5940-00-682-2445	96906	MS25036-158
19	6	5935-00-691-5591	97403	13207E6498-2
19	7	5310-00-833-8567	19207	8338567
19	8	5999-00-057-2929	96906	MS27148-2
19	9	5940-00-113-8183	96906	MS25036-113
20	1	6150-01-362-5216	45152	1860820
20	2	5935-00-146-5811	71468	CA3106F10SL3SF80
20	3	5935-01-112-9782	71468	CA3106F18-1PF80
20	4	5935-01-112-9792	71468	CA3100F18-1SF80
21	1	5305-01-082-0049	11939	93544216
21	2	5310-01-068-8446	45152	354AX
21	3	5340-01-355-3794	45152	1862350
21	4	5340-01-355-5248	45152	1862360
21	5	3990-01-358-1146	45152	3SK804
21	6	5340-01-363-6139	45152	1953740
21	7	5305-01-328-4384	45152	738HX4
21	8	5310-01-133-2130	45152	355AX
21	9	3990-01-357-1944	45152	3SK805
21	10	5310-01-355-8794	2K272	W08
21	11	5310-00-185-6389	08162	N08
21	12	3120-01-355-8843	45152	1862340
21	13	5310-01-459-6126	2K272	W09
21	14	5310-01-459-6206	2K272	N09
21	15	3910-01-397-5277	45152	1862230W
22	1	5305-01-167-9408	45152	128131A
22	2		45152	3053453
22	3	5310-01-159-8178	45152	110310A
22	4	4030-00-278-0715	90202	M885AG
22	5	5315-00-187-9420	96906	MS24665-717
22	6	5310-01-150-5918	45152	110312A
22	7		45152	3055925
22	8		45152	3051989
22	8		45152	3051990
22	9	5305-01-185-8668	45152	126536A
22	10	5305-01-149-1934	45152	111320A
22	11	5305-01-196-8088	52167	WE1030TB
22	12	5305-01-154-4323	45152	1317120

CROSS-REFERENCE INDEXES

FIG.	ITEM	FIGURE AND ITEM NUMBER INDEX		
		STOCK NUMBER	CAGEC	PART NUMBER
22	13	5305-01-155-3478	45152	1324980
22	14		45152	3053912
22	15		45152	3055128
23	1	5670-01-408-8386	45152	1971460W
23	2	5306-01-106-7496	52167	WE0818TB
23	3		45152	3054537
23	4	5310-01-111-0645	45152	110311A
23	5		45152	3054536
23	6	5305-01-341-3090	52167	WE0628TB
23	7	5310-01-159-8178	45152	110310A
23	8	5310-01-457-8573	45152	720HX
23	9	5360-01-236-2072	45152	1307840
24	1	5305-01-353-8267	45152	1754220
24	2	5340-01-153-0313	45152	1330560
24	3	5340-01-364-4343	45152	1976560
24	3	5340-01-364-1959	45152	1976570
24	4	5305-01-344-8899	45152	1606140
24	5	5305-01-353-8268	45152	1754300
24	6	2510-01-357-8795	45152	1783090
24	6	2510-01-357-8796	45152	1783100
24	7	5305-01-157-5624	45152	1324510
24	8	5340-01-081-1718	28520	DP-312
24	9	5340-01-151-8391	83014	H360-5-2
24	10	5310-01-159-8178	45152	110310A
24	11	5340-01-356-8487	45152	1937190
24	12	5305-01-156-5445	52167	WE0630TB
24	13	2510-01-357-2507	45152	1783110
24	14	5310-01-346-9445	45152	1600460
24	15	5310-01-288-1116	45152	1437220
24	16	2510-01-357-5691	45152	1921380
24	17	2510-01-364-4489	45152	2068380
24	18	5310-00-880-0626	19207	10892331
24	19	2540-01-131-6242	45152	1321600
24	20	5310-01-340-5671	45152	1333510
25	1		45152	3263040
25	2	2540-01-222-9653	45152	1500280
25	3	5305-00-988-1724	96906	MS35206-280
25	4	9905-00-205-2795	96906	MS35387-1
25	5	5310-01-346-9445	45152	1600460
25	6		96906	MS24665-624
25	7	2540-01-134-3714	45152	1312410
26	1	5305-01-249-8564	45152	59031AX
26	2	2540-01-152-7764	64386	67D794
26	3	5305-01-062-1017	45152	1367HX1
26	4	5305-01-203-8360	80204	B1821BH025C175N
26	5	5340-01-156-6776	64386	277-A-80-1
26	6	5310-00-984-3806	96906	MS51922-9
26	7	5310-01-288-1116	82458	T893R
26	8	5306-01-287-5715	52167	WC0414PB
26	9	5310-00-208-1918	88044	AN365-1024A

CROSS-REFERENCE INDEXES

FIG.	ITEM	FIGURE AND ITEM NUMBER INDEX STOCK NUMBER	CAGEC	PART NUMBER
26	10	5340-01-354-0175	45152	1778690W
26	11	5310-00-061-4650	96906	MS51943-31
26	12	5340-01-092-1637	74687	028-561
27	1	9905-00-282-3639	96906	MS35387-2
27	2	5305-01-159-8544	96906	MS35206-280
28	1	9905-01-459-4979	45152	3126523
28	2	5320-01-351-5621	3Z048	BTT43
28	3		45152	3285672
28	4	5305-01-134-2052	45152	1381HX1
28	5		45152	3064067
28	6	9905-01-157-1026	45152	1320590
28	7		45152	3064068
28	8	9905-01-361-8611	45152	1783190
28	9		45152	1987130
28	10		45152	3285659
28	11	5305-00-253-5614	96906	MS21318-20
28	12	9905-01-358-7089	45152	1948290
28	13	9905-01-358-4270	45152	1920730
28	14	9905-01-358-6746	45152	1785220
29	1	2540-01-358-1218	45152	1861950
29	2	2590-01-414-3179	45152	1861940
29	3	5330-01-355-9269	01212	80X100X10
29	4	5365-01-355-9529	2K272	GLY.PG808560A
29	5	4730-01-217-1115	45152	615FX
29	6	5315-01-361-2721	45152	1862720W
29	7		45152	1394510-012
29	8	4030-01-456-1150	35111	811
29	9	5310-01-216-2799	72447	330734
29	10	5315-00-917-6226	96906	MS24665-15
29	11	5340-01-356-8373	45152	1862770
29	12	5340-01-355-9368	45152	1897980
29	13	5305-01-061-7910	45152	2013HX1
29	14	5310-01-129-0450	45152	351AX
29	15	5310-00-880-0626	19207	10892331
29	16	3040-01-356-4589	45152	1863010W
29	17	5310-01-342-8595	45152	1598030
29	18	5310-01-458-0248	2K272	W12
29	19	5310-00-185-6345	96906	MS19068-121
29	20		45152	1394510-018
29	21	5315-01-355-3744	96652	28-04
29	22	2530-01-356-4614	45152	1860250W
29	23	5365-01-355-7358	45152	1862830
29	24	5325-00-175-1315	96906	MS16624-250
29	25	2530-01-356-4613	45152	1860310W
29	26	5365-01-355-7357	45152	1862820
29	27	5325-00-282-7149	79136	5100-315
29	28	3040-01-356-6837	45152	1862690W
29	29	2510-01-453-8548	45152	3051121
29	30	5310-01-150-5918	45152	110312A
29	31		45152	3053913

CROSS-REFERENCE INDEXES

FIGURE AND ITEM NUMBER INDEX

FIG.	ITEM	STOCK NUMBER	CAGEC	PART NUMBER
29	32		45152	3055129
29	33	5305-01-155-3478	45152	111320A
29	34	4030-01-258-0467	96906	MS51844-43
29	35		45152	1533100-022
29	36	5315-01-363-6984	45152	1956170
29	37	5315-01-363-7062	45152	1965220
29	38		45152	3055132
29	39	5340-01-204-4888	84971	TA720-S8
29	40	5310-01-343-5712	10001	2533408-26
29	41	5310-01-038-2294	81349	M12133/1-12P
29	42	5310-01-214-4946	45152	2083HX
29	43	5306-01-086-2368	45152	EE103647
29	44	5306-01-159-6549	45152	111452A
29	45	5306-01-150-7726	45152	120622A
29	46		45152	3053774
29	46		45152	3053775
29	47	5310-01-111-0645	45152	110311A
29	48		45152	3053776
29	49	5306-01-156-5429	52167	WE0820TB
29	50	5310-01-061-5301	45152	8865GX
29	51		45152	3053777
29	52		52167	WE0816TB
29	53	2510-01-457-5270	45152	3056872
30	1	3040-01-374-4803	63899	150234B
30	2	5305-01-355-2643	63899	711009A
30	3	5305-01-355-2641	63899	711053A
30	4	5365-01-355-9965	63899	500419B
30	5		63899	702001A
30	6		63899	701121A
30	7		63899	706069A
30	8		63899	703425A
30	9		63899	704425A
30	10		63899	721175A
30	11		63899	721176A
30	12	3040-01-373-0500	63899	700079A
30	13	5340-01-372-3982	63899	715001A
30	14	5305-01-355-2642	63899	711083A
31	1	4730-01-355-5140	45152	1891390
31	2	4820-01-355-8975	0FHH8	E2A50Y4350NMK2
31	3		0FHH8	8024N912
31	4		0FHH8	8025N9016
31	5		0FHH8	8023N7015
31	6		0FHH8	8025N9015
31	7		0FHH8	8022N7017
31	8	4810-01-355-8979	0FHH8	GS028000N
31	9		0FHH8	900565-012
31	10		0FHH8	8023N7009
31	11	5331-01-457-1834	0FHH8	8024N908
31	12	4820-01-355-8980	0FHH8	9P000202
31	13	5950-01-355-7136	0FHH8	CCS024D
31	14	5340-01-389-3537	0FHH8	8H38529/53

CROSS-REFERENCE INDEXES

FIG.	ITEM	FIGURE AND ITEM NUMBER INDEX STOCK NUMBER	CAGEC	PART NUMBER
31	15	5340-01-389-3462	0FHH8	801001M
31	16		0FHH8	8024N902
31	17	5331-01-355-9911	0FHH8	8023N7013
31	18	4730-00-853-1182	01276	202702-8-8S
31	19		01276	22617-8
31	20	5310-01-355-8798	45152	1937550
31	21	5305-01-459-3059	45152	3064801
32	1	4730-01-356-9875	0FHH8	8F 3931
32	2	5365-01-355-5141	0FHH8	801004M
32	3		0FHH8	8024N905
32	4	5365-01-355-5142	0FHH8	801006M
32	5	5331-01-457-1834	0FHH8	8024N908
32	6	5365-01-361-5599	0FHH8	801005M
32	7	5331-01-460-9137	0FHH8	8024N906
32	8	4730-01-355-9043	0FHH8	801003M
32	9	5331-01-457-3314	0FHH8	8024N904
32	10	5340-01-389-3462	0FHH8	801001M
32	11		0FHH8	8024N902
32	12	4810-01-356-0501	0FHH8	A4B125T053525N
32	13		0FHH8	8024N914
32	14		0FHH8	8023N7017
32	15		0FHH8	8025N9018
32	16		0FHH8	8023N7018
32	17		0FHH8	8025N9017
32	18	5340-01-389-3537	0FHH8	8H38529/53
32	19	4820-01-356-2632	0FHH8	D2A60-5.0N
32	20		0FHH8	8024N910
32	21		0FHH8	8025N9013
32	22		0FHH8	8022N7014
32	23	4820-01-356-5559	0FHH8	E2E125Z4350NMK2
32	24		0FHH8	8022N7019
32	25		0FHH8	8025N9019
32	26		0FHH8	8025N9020
32	27		0FHH8	8022N7020
32	28		0FHH8	8024N916
32	29	4810-01-356-4487	0FHH8	9DD000240
32	30	5331-01-460-9149	0FHH8	8023N7011
32	31	5305-01-355-1355	0FHH8	804902B1W
32	32	4810-01-373-7257	0FHH8	9DD000239
32	33		0FHH8	8023N7009
32	34	5305-01-355-1360	0FHH8	9DD000241
32	35	5340-01-389-3537	0FHH8	8H38529/53
32	36	5930-01-355-7099	0FHH8	9DD000255
32	37	5331-01-457-1834	0FHH8	8024N908
32	38	5331-01-460-9149	0FHH8	8023N7011
32	39	5950-01-355-7136	0FHH8	CCS024D
32	40	4810-01-356-0505	0FHH8	GS028510N
32	41	5331-01-457-1834	0FHH8	8024N908
32	42		0FHH8	900565-012
32	43		0FHH8	8023N7009

CROSS-REFERENCE INDEXES

FIG.	ITEM	FIGURE AND ITEM NUMBER INDEX		
		STOCK NUMBER	CAGEC	PART NUMBER
33	1	4730-01-327-7081	01276	2043-16-16S
33	2	4710-01-356-8756	45152	1923580
33	3	4710-01-356-8755	45152	1923570
33	4	4730-00-917-4794	79470	5515X8
33	5	5330-01-244-2273	01276	22617-8
33	6	4730-01-011-7736	96906	MS51527A12
33	7	5331-00-228-7196	01276	22617-12
33	8	4730-00-173-1881	96906	MS51525A12-16
33	9	5331-00-228-7196	01276	22617-12
33	10	4730-01-355-9003	01276	206209-12-12S
33	11	5331-00-228-7196	01276	22617-12
33	12	4730-01-242-1290	01276	206209-8-8S
33	13	5330-01-244-2273	01276	22617-8
33	14	4730-01-221-2080	01276	FD45-1169-16-16
33	15	4730-01-220-8297	01276	FD45-1168-16-16
33	16	4730-01-241-4650	01276	2266-16-16S
33	17	5330-01-168-0885	01276	22617-16
34	1	5340-01-355-3713	45152	1862640
34	2	5340-01-168-7285	57733	752023
34	3	5305-00-958-5246	96906	MS35190-289
34	4	5310-01-346-9445	45152	1600460
34	5	5365-01-394-3553	45152	2063940
34	6	5310-00-167-0767	88044	AN970-5
34	7	5310-01-068-8446	45152	354AX
34	8	5305-01-062-1017	45152	1367HX1
34	9	5305-00-470-3321	96906	MS51849-74
34	10	5310-01-288-5096	78519	1571850
34	11	5340-01-355-5268	45152	1862530W
34	12	5305-01-296-0341	45152	736HX1
34	13	5310-01-129-0450	45152	351AX
34	14	5340-01-394-2420	45152	2048840W
34	15	5306-01-287-5714	52167	WC0412PB
34	16	5340-00-404-4100	75272	COV2113
34	17	5342-01-175-0316	45152	3737FX3
34	18	5340-01-317-5450	53606	CJV-0809
34	19	5305-01-344-8899	45152	1606140
34	20	5310-01-346-9445	45152	1600460
34	21	5305-01-337-9120	45152	1754140
34	22		45152	3053657
34	23	5310-01-288-1116	82458	T893R
34	24	5305-01-340-5061	45152	1754280
34	25	5340-01-394-2421	45152	2048850W
34	26		45152	3053658
34	27	5310-01-062-3379	45152	362AX
34	28	5305-01-118-8860	96906	MS51105-367
34	29	5305-01-355-1428	45152	50619AX
34	30	5306-01-287-5715	52167	WC0414PB
34	31	5340-01-355-5259	45152	1862510W
35	1		45152	3056242
35	2		45152	3056245

CROSS-REFERENCE INDEXES

FIG.	ITEM	FIGURE AND ITEM NUMBER INDEX STOCK NUMBER	CAGEC	PART NUMBER
35	3		45152	3056240
35	4		45152	3056244
35	5	5306-01-341-0712	45152	1756870
35	6	5340-01-363-6141	45152	1779770
35	7	5310-01-340-5671	45152	1333510
35	8	5306-01-287-5714	52167	WC0412PB
35	9		45152	3057867
35	10	5305-01-340-0225	45152	1754210
35	11	5340-00-224-1204	84971	TA720S24
35	13		45152	3056238
35	14		45152	3056239
35	15		45152	3056243
35	16		45152	3056241
36	1	4730-01-356-8646	K0274	A16-17J1CBHR
36	2	5331-01-168-8112	K0274	200-214-4490
36	3	4730-00-266-6772	96906	MS51520A8S
36	4	5310-00-933-6120	96906	MS35338-138
37	1	5305-01-203-8360	45152	1337630
37	2	5310-00-582-5965	96906	MS35338-44
37	3	5310-00-809-4058	96906	MS27183-10
37	4	5340-01-231-3916	53790	DP-3
37	5	5340-01-355-8247	53790	3254PA
37	6	4710-01-360-2292	45152	1862620
37	7	4710-01-356-7535	45152	1862610
38	1	5306-00-816-5272	96906	MS35307-340
38	2	5310-01-068-8446	45152	354AX
38	3	5310-01-061-7452	45152	1804HX
38	4	5340-01-172-1566	53790	GD-3D
38	5	5340-01-355-3733	53790	3190/190-PA
38	6	4710-01-361-3985	45152	1862600
38	7	4710-01-360-2293	45152	1862580
38	8	4710-01-358-6946	45152	1862570
38	9	5310-01-141-5565	45152	2150HX1
38	10	5306-01-164-7437	45152	1849HX1
38	11	4730-01-355-9000	K0274	A12-12JICMSCR
38	12		K0274	200-116-4490
38	13	4720-01-356-6804	01276	FK1328HHH0224
38	14	4710-01-360-9502	45152	1862590
39	1	4730-01-356-2653	K0274	A12-12JICBHMER
39	2		K0274	200-116-4490
39	3	5310-01-420-7626	96906	MS35338-138
40	1	3040-01-356-2707	63899	150235B
40	2	5305-01-355-2643	63899	711009A
40	3	5305-01-355-2641	63899	711053A
40	4	5365-01-355-9965	63899	500419B
40	5		63899	702001A
40	6		63899	701121A
40	7		63899	706069A
40	8		63899	703425A
40	9		63899	704425A

CROSS-REFERENCE INDEXES

FIGURE AND ITEM NUMBER INDEX

FIG.	ITEM	STOCK NUMBER	CAGEC	PART NUMBER
40	10		63899	721175A
40	11	5340-01-372-3982	63899	715001A
40	12	5305-01-355-2642	63899	711083A
40	13		63899	721176A
40	14	3040-01-373-0500	63899	700079A
41	1	4720-01-356-4556	01276	FU680HHH0260180
41	2	4720-01-356-4557	01276	FU681HHH0300180
41	3	4730-00-925-8039	00624	202702-12-8S
41	4		01276	22617-12
41	5	4820-01-356-6765	0FHH8	8F3930
41	6	5331-01-355-9911	0FHH8	8023N7013
41	7	4810-01-356-2637	0FHH8	A5B060014350N
41	8	5331-01-457-1834	0FHH8	8024N908
41	9		0FHH8	8025N9011
41	10		0FHH8	8022N7011
41	11	5365-01-355-5141	0FHH8	801004M
41	12		0FHH8	8024N905
41	13	4820-01-356-2638	0FHH8	9DD000140
41	14	5305-01-459-3059	45152	3064801
41	15	5310-01-355-8798	45152	1937550
42	1	5305-01-344-5532	45152	1846HX1
42	2	5310-01-068-8446	11939	93613642
42	3	5310-01-061-7452	45152	1804HX
42	4	4730-01-156-4835	81343	8-8 070120CA
42	5	5330-01-244-2273	01276	22617-8
42	6	4720-01-356-4555	01276	FK1329HHH0244
42	7	4730-01-356-0687	K0274	A16-17DBMSCR
42	8	5331-01-116-8112	K0274	200-214-4490
42	9	5331-00-395-5737	K0274	200-912-4490
42	10	4730-01-356-1018	45152	1891380
43	1	4730-01-221-2080	01276	FD45-1169-16-16
43	2	4730-01-220-8297	01276	FD45-1168-16-16
43	3	4730-00-177-5894	81343	16-16 080320CA
43	4		01276	22617-8
43	5	4730-01-462-2632	01276	221501-16-12S
43	6	5331-00-228-7196	01276	22617-12
43	7		45152	1456530
43	8		45152	3056237
44	1	6150-01-461-9183	45152	3181842
44	2	5935-01-112-9782	71468	CA3106F18-1PF80
44	3	5935-00-146-5811	71468	CA3106F10SL-3SF80
44	4	5935-01-339-3227	64678	1530 0002
44	5	5940-01-462-1718	77060	15300014
44	6	5940-01-462-1717	77060	12048159
44	7	5975-01-226-8078	77060	12010293
44	8	4935-01-308-7866	77060	15300027
44	9	5940-01-353-3175	77060	12077411
44	10	5975-01-339-9574	77060	12010300
44	11	4935-01-308-7866	77060	15300027
44	12	5940-01-462-1718	77060	15300014
45	1	6150-01-461-9229	45152	3135770

CROSS-REFERENCE INDEXES

FIGURE AND ITEM NUMBER INDEX

FIG.	ITEM	STOCK NUMBER	CAGEC	PART NUMBER
46	1		45152	3353067
46	2	5935-01-112-9782	71468	CA3106F18-1PF80
46	3	5935-01-357-1036	71468	CA3101F18-1SF80
46	4	5935-00-146-5811	71468	CA3106F10SL-3SF80
47	1		45152	3349086
47	2	5940-00-399-6676	19207	8338564
47	3	5970-00-833-8562	19207	8338562
47	4	5975-00-660-5962	19207	8724494
47	5	5940-00-143-4777	96906	MS25036-157
47	6	5935-00-691-5591	97403	13207E6498-2
47	7	5310-00-833-8567	19207	8338567
47	8	5999-00-057-2929	19204	572929
47	9	5940-00-113-8183	96906	MS25036-113
48	1	5365-01-459-8230	45152	2221970
48	2	5930-01-462-2954	45152	3135832
48	3	5340-01-462-6138	45152	3122223
48	4	5340-01-462-3360	45152	2265340
49	1		45152	3135832
49	2		45152	3353063
49	3		45152	3353061
50	1		45152	3353059
50	2		53867	0332207402
50	3	5305-00-984-6210	45152	59030AX
50	4		45152	3353069
50	5		53867	3334485045
50	6		00779	60435-1
50	7	5940-01-353-6476	00779	60253-2
50	8	5935-01-462-3056	71468	BFR20-29S-1
50	9	5999-01-372-4955	11139	5962-202-16141
50	10		11139	DT06-4S
50	11	5310-01-458-0248	11139	W4S
50	12	5935-01-174-1235	11139	114017
50	13	5935-00-655-3120	71468	BFR18-1S-1
50	14		11139	DT04-4P-RT
50	15		45152	3135833
50	16		45152	3353066
50	17	5310-00-582-5965	96906	MS35338-44
50	18	5305-01-306-3507	96906	MS51488-2
50	19	5325-01-395-0827	78276	ALS7-1024-130
50	20		45152	3389198
50	21		45152	2CH281
50	22	5310-01-288-5096	45152	1571850
50	23	5305-00-988-1171	96906	MS35206-285
50	24	5310-00-809-4058	96906	MS27183-10
50	25		45152	3217374
50	26	5310-01-066-6759	72962	21NE-040
51	1		45152	3349084
51	1		45152	3349085
51	2		13548	07195
51	3		13548	07197
51	4	6150-01-459-1811	13548	94626

CROSS-REFERENCE INDEXES

FIG.	ITEM	FIGURE AND ITEM NUMBER INDEX		
		STOCK NUMBER	CAGEC	PART NUMBER
51	5	5980-01-459-2073	13548	30250Y
51	6	5305-00-059-3660	96906	MS51958-64
51	7		13548	07198
51	8		13548	5370
51	9	5305-01-249-8564	45152	59031AX
51	10	5310-01-288-5096	45152	1571850
51	11		45152	3349083
51	12	5940-00-143-4794	96906	MS25036-112
51	13	5935-00-691-5591	19207	8724495
51	14	5310-00-833-8567	19207	8338567
51	15	5999-00-057-2929	96906	MS27148-2
51	16		45152	2270080W
51	16		45152	2270090W
51	17	5342-01-384-9511	42366	16282B-35005
51	18	5310-01-129-0450	45152	351AX
51	19	5310-01-063-8970	45152	434-A
51	20	5310-01-129-0450	45152	351AX
51	21	5310-01-063-8970	45152	434-A
51	22	5340-01-317-5450	75272	COV0713
51	23	5306-01-287-5715	52167	WC0414PB
51	24		45152	3150265
51	24		45152	3149277
51	25	5325-00-922-6273	70485	2406
51	26		82458	T892R
51	27		45152	3348988
51	28		13548	07195
51	29		13548	07198
51	30	5980-01-459-2073	13548	30250Y
51	31	5305-00-059-3660	96906	MS51958-64
51	32	6150-01-459-1811	13548	94626
51	33		13548	07197
51	34		13548	5370
51	35	5305-01-249-8564	45152	59031AX
51	36	5310-01-288-5096	45152	1571850
51	37	5340-01-419-1315	83014	H360K2598
51	38	5342-01-384-9511	43266	16282B-35005
51	39		45152	3217377
51	40	5310-01-129-0450	45152	351AX
51	41	5310-01-063-8970	45152	434-A
52	1		45152	3188476
52	2	5315-01-459-1409	96652	28-06
52	3	4030-01-258-0467	96906	MS51844-43
52	4	5305-01-431-5149	45152	1533100-32
53	1	5340-01-462-5704	45152	3123917
53	1	5340-01-462-5703	45152	3123918
53	2	5325-00-282-7149	79136	5100-315
53	3	5340-01-462-6637	45152	3117428
53	3	5340-01-462-6645	45152	3117429
53	4		45152	2196790
53	5	5315-01-462-7515	45152	3129006
53	6		45152	1840070

CROSS-REFERENCE INDEXES

FIGURE AND ITEM NUMBER INDEX

FIG.	ITEM	STOCK NUMBER	CAGEC	PART NUMBER
53	7	5360-01-462-7636	45152	3126499
53	8	5315-01-462-7513	45152	3128999
53	9		45152	1860310 W
53	10	5365-01-355-7357	45152	1862820
53	11	5930-01-462-1321	81901	E1117-525
53	12	5305-01-359-7965	45152	2CH281
53	13	5305-00-068-0508	80204	B1821BH025C075N
53	14	5310-00-809-4058	96906	MS27183-10
53	15	5340-01-038-9481	75272	COV050971
53	16	5310-01-462-6502	45152	2253880
53	17	5325-00-175-1315	96906	MS16624-250
53	18	5310-01-062-3379	45152	362AX
53	19	5315-01-462-5971	45152	3117567
53	20	5315-01-459-7340	45152	1749HX
53	21	5315-01-462-5888	45152	3117504
53	22	5315-01-462-5890	45152	3117505
53	23	5360-01-462-8548	45152	3117507
53	24	5305-01-357-4682	45152	1754310
53	25		82458	T892R
53	26	5365-01-355-9529	2K272	GLY.PG 808560A
53	27	5330-01-355-9269	01212	80X100X10
53	28	5310-01-151-1036	45152	115307A
53	29	3040-01-462-5032	45152	3121863
54	1	5305-01-165-3297	45152	115306A
54	2	5330-01-463-1208	01212	800850
54	3	5310-01-462-6513	45152	2254220
54	4	3120-01-462-1442	45152	2258840
54	5	5340-01-462-6483	45152	3121846
54	5	5340-01-462-6628	45152	3121847
54	6	5330-01-463-1204	01212	801000
54	7	3120-01-462-1431	2K272	GLY.PG657070A
54	8		45152	3119744
54	9	5310-01-462-6509	45152	3124572
54	10	5325-00-175-1315	96906	MS16624-250
54	11	5305-00-068-0508	80204	B1821BH025C075N
54	12	5310-00-809-4058	96906	MS27183-10
54	13	5340-01-038-9481	75272	COV050971
54	14	5330-01-463-1206	70485	OR150
54	15		45152	3218659
54	15		45152	3218660
54	16		45152	3117546
54	16		45152	3127724
55	1		45152	3126527
55	1		45152	3126528
55	2	4710-01-462-1238	45152	3127712
55	3		45152	1840070
55	4		45152	1833HX1
55	5	5306-01-236-1585	45152	1336700
55	6		45152	3227252
55	7	5315-01-462-5964	45152	3127723
55	8	5305-01-280-7901	45152	66420AX

CROSS-REFERENCE INDEXES

FIG.	ITEM	FIGURE AND ITEM NUMBER INDEX		
		STOCK NUMBER	CAGEC	PART NUMBER
55	9	5310-00-809-4058	96906	MS27183-10
55	10	5310-01-062-3379	45152	362AX
55	11		45152	1321570
55	12	2510-01-462-4683	45152	3121882
55	13	2530-01-462-0714	45152	3127711
55	14		45152	2176780
55	15	5306-01-155-9765	45152	115304A
56	1	5340-01-462-1762	45152	3192798
56	1	5340-01-462-3365	45152	3192799
56	2	5305-01-150-7736	45152	115293A
56	3	5310-01-159-8178	45152	110310A
56	4	5305-01-274-0028	93907	234 86500-382
56	5	5310-01-353-6045	45152	2302HX
56	6		45152	1533100-40
56	7	4030-01-258-0467	96906	MS51844-43
56	8		45152	2255150
56	9	5340-01-462-3367	45152	3117420
56	10	5340-01-462-1761	45152	3138310
56	11	5306-01-236-1585	45152	1336700
56	12	5305-01-154-4323	45152	1317120
56	13	5305-01-196-8088	45152	111319A
56	14	5310-01-150-5918	45152	110312A
56	15	5305-01-156-5440	45152	1337720
56	16	5340-01-462-5702	45152	3124573
56	17		45152	3335177
56	18		45152	3335176
56	19		45152	2255160
56	20	5340-01-462-5443	45152	3124574
57	1	5310-01-111-6450	45152	110311A
57	2		45152	3217375
57	3	5305-01-242-0655	45152	120699A
57	4		45152	3353148
57	4		45152	3353147
57	5	5310-01-150-5918	45152	110312A
57	6	5315-00-465-8928	96906	MS16624-4175
57	7	3120-01-461-8627	2K272	GE45E8-2RS
57	8	5325-01-462-7182	45152	1862320
57	9		45152	3127711
57	10	5325-00-722-8570	79136	N5000-268
57	11	2510-01-462-4677	45152	3121879
57	12	5315-01-429-6971	45152	2173040
57	13		45152	2173040XA
57	14	4030-01-315-7354	37581	NICROPRESS18-1C
57	15		45152	1533100-10
57	16	5315-00-182-6769	45152	EE40567
57	17	5305-01-344-8899	45152	1606140
57	18	5340-01-038-9481	75272	COV050971
57	19	3040-01-462-5029	45152	3121881
57	20		45152	3227252
57	21	5310-01-151-1036	45152	115307A
57	22	5306-01-236-1585	45152	1336700

CROSS-REFERENCE INDEXES

FIGURE AND ITEM NUMBER INDEX

FIG.	ITEM	STOCK NUMBER	CAGEC	PART NUMBER
57	23		45152	3353065
57	24		45152	111320A
57	25		45152	3145738
57	26	5305-01-156-5445	45152	WE0816TB
58	1	5310-01-111-6450	45152	110311A
58	2		45152	3359606
58	3	5310-01-159-8178	45152	110310A
58	4		45152	1556620
58	5	5305-01-155-3478	45152	1324980
58	6		45152	3346716
58	7	5305-01-340-0225	45152	1754210
58	8	5340-00-224-1204	84971	TA720S24
58	9	5310-01-340-5671	45152	1333510
58	10		45152	3344561
58	11	5305-01-154-4323	45152	1317120
58	12		45152	3344562
58	13	5306-01-156-5429	52167	WE0820TB
58	14	5305-01-150-7736	45152	115293A
58	15		52167	3357391
58	16		45152	3357080
58	17	5310-01-342-8595	45152	1598030
58	18	5310-01-111-6450	45152	110311A
58	19		45152	3217276
58	20	5306-01-150-7726	45152	120622A
58	21	5305-01-156-5440	45152	1337720
58	22	5305-01-155-4357	45152	111315A
58	23		28520	DP-1750-2773
58	24		45152	3355525
58	25	5305-01-156-5440	45152	1337720
58	26	5305-01-147-9723	45152	111317A
58	27	5305-01-341-3090	45152	1781440
58	28	5310-01-457-8573	45152	720HX
58	29	5305-01-236-5107	45152	1772HX2
58	30	5315-01-215-7505	96652	63-02
58	31	4730-01-450-5139	06721	1737095
58	32		45152	2282360-28
58	33		45152	3345899
58	34	5315-01-480-7516	45152	3124495
58	35		45152	1533100-52
58	36	4030-01-258-0467	96906	MS51844-43
58	37	5315-01-358-3736	96652	28-07
58	38		45152	3346009
58	39		45152	3347761
58	40	5315-01-429-6971	45152	2173040
58	41		45152	3346010
58	42		45152	3234880
58	43		45152	3143298
58	44	2590-01-462-5751	45152	3143309
59	1	2510-01-429-9684	45152	2172220W
59	2		45152	2172250
59	3	5315-01-431-9369	05FJ2	2172260

CROSS-REFERENCE INDEXES

FIGURE AND ITEM NUMBER INDEX

FIG.	ITEM	STOCK NUMBER	CAGEC	PART NUMBER
59	4		45152	2172260XA
59	5	4030-01-315-7354	37581	NICROPRESS18-1C
59	6		45152	1533100-015
59	7	5315-01-358-3736	96652	28-07
59	8	5340-01-462-3362	45152	2172170W
59	9		45152	3188569
59	10	3120-01-461-8639	45152	3124496
59	11	5315-01-429-7296	05FJ2	2176240
59	12		45152	2172640XA
59	13		45152	1533100-022
59	14	4030-01-315-7354	37581	NICROPRESS18-1C
59	15	5315-01-358-3736	96652	28-07
59	16	5340-01-462-5711	45152	3122230
59	17		45152	3117462
59	18		05FJ2	2172260
59	19	5315-01-358-3736	96652	28-07
59	20	4030-01-315-7354	37581	NICROPRESS18-1C
59	21		45152	2173040XA
59	22		45152	1533100-015
59	23	2510-01-462-4688	45152	3119747
59	24		45152	1533100-026
59	25	5315-01-358-3736	96652	28-07
59	26	4030-01-258-0467	96906	MS51844-43
59	27	5315-01-429-6971	05FJ2	21730470
59	28		45152	2173040X1
59	29		45152	1533100-013
59	30	5315-00-182-6769	45152	EE40567
59	31	4030-01-315-7354	37581	NICROPRESS18-1C
59	32	5340-01-462-5709	45152	3122231
59	33		45152	3117461
59	34		05FJ2	2176430
59	35		45152	2176430XA
59	36		45152	1533100-015
59	37	5315-01-358-3736	96652	28-07
59	38	4030-01-315-7354	37581	NICROPRESS18-1C
59	39		45152	3217508
59	40	5315-01-463-0139	05FJ2	3123921
59	41	5315-00-182-6769	45152	EE40567
59	42	4030-01-315-7354	37581	NICROPRESS18-1C
59	43		45152	3123921XA
59	44		45152	1533100-021
59	45	5340-01-462-1757	45152	3191030
59	46	5315-01-431-0602	05FJ2	2207830
59	47		45152	2207830XA
59	48	4030-01-315-7354	37581	NICROPRESS18-1C
59	49		45152	1533100-018
59	50		45152	2207830XA
59	51		45152	3252505
59	52	5305-01-353-8267	45152	1754220
59	53	4030-01-258-0467	96906	MS51844-43
59	54	5315-01-395-4217	0J7N2	LP0800

CROSS-REFERENCE INDEXES

FIGURE AND ITEM NUMBER INDEX

FIG.	ITEM	STOCK NUMBER	CAGEC	PART NUMBER
59	55	5340-01-458-6165	45152	2176250W
59	56	5315-01-459-7340	45152	1749HX
59	57	5315-01-459-7337	45152	2152250
59	58		45152	1533100-012
59	59	5310-01-105-7229	06853	244095
59	60		45152	2232480
59	61	5340-01-462-3363	45152	2235270W
59	62	5305-01-458-6171	45152	3325280
59	63	2510-01-461-2924	45152	3117463
59	64		65059	T15096A-100
59	65	9330-01-375-9240	80372	87024A0522
59	66	5340-01-375-6932	80372	87024A0521
59	67		65059	T15044A-100
59	68		65059	806PX15
59	69		65059	806PX12
59	70		65059	8061508-1ZN
59	71	4730-01-450-5139	06721	1737095
59	72		45152	2008530-006
59	73	5315-01-363-7062	45152	1965220
59	74	2510-01-462-4681	45152	2242310W
60	1	5310-01-150-5918	45152	110312A
60	2	5305-01-156-5440	45152	1337720
60	3	5305-01-154-4323	45152	1317120
60	4	5310-01-166-1708	45152	53925AX
60	5		45152	3349157
60	6	5305-00-732-0511	80204	B1821BH050C113N
60	7		45152	3340898
60	8	5305-01-152-4223	45152	1337430
61	1	5305-00-253-5614	96906	MS21318-20
61	2		1DK67	3152164
61	3		1DK67	3152167
61	4	5320-01-083-9619	05693	CCP-42
61	5	9905-01-463-1432	1DK67	3152159
61	6	5320-00-173-8625	07707	SSD44-SSBS
61	7		45152	3367305
61	8	5305-01-353-8267	45152	1754220
61	9		45152	3373285
61	10		1DK67	3152169
61	11	5310-01-340-5671	45152	1333510
61	12		1DK67	3152161
61	13		1DK67	3117421
61	14		1DK67	3152168
61	15		1DK67	3152174
61	16	9905-01-361-8611	45152	1783190
61	17	5320-01-351-5621	3Z048	BTT43
62	1	5315-00-465-8928	96906	MS16624-4175
62	2	5315-01-462-2073	45152	2152010
62	3		45152	3227120
KITS		5330-01-394-3549	63899	430457B
KITS		5330-01-363-0667	0FHH8	9S000104
KITS		5330-01-393-5075	0FHH8	9S000105

CROSS-REFERENCE INDEXES

FIG.	ITEM	FIGURE AND ITEM NUMBER INDEX		PART NUMBER
		STOCK NUMBER	CAGEC	
KITS		5330-01-372-8377	0FHH8	9S000106
KITS			0FHH8	SK3-0002N-1
KITS		5330-01-357-7511	0FHH8	SK3-0017N-1
KITS		5330-01-357-7512	0FHH8	SK3-0024N-1
KITS		5330-01-357-7903	0FHH8	SK3-0035N-1
KITS		5330-01-357-7510	0FHH8	SK3-0039N-1
KITS		5330-01-355-9248	0FHH8	SK3-0088N-1
BULK	1	4010-01-237-7544	80535	031-0424
BULK	2		45152	1533100
BULK	3		45152	121782A
BULK	4		77060	R-64932

APPENDIX D

COMPONENTS OF END ITEM & BASIC ISSUE ITEMS LISTS

Section I. Introduction

D-1. SCOPE.

This appendix lists components of end item and basic issue items for the M1120 series vehicles to help inventory items required for safe and efficient operation.

D-2. GENERAL.

The Components of End Item (COEI) and Basic Issue Items (BII) lists are divided into the following sections:

a. Section II. Components of End Item. This listing is for informational purposes only and is not authority to requisition replacements. These items are part of the end item, but are removed and separately packaged for transportation or shipment. As part of the end item, these items must be with the end item whenever it is issued or transferred between property accounts. Illustrations are furnished to assist in identifying the items.

b. Section III. Basic Issue Items. These are the minimum essential items required to place the M1120 series vehicles in operation, to operate them, and to perform emergency repairs. Although shipped separately packaged, BII must be with the vehicle during operation and whenever it is transferred between property accounts. The illustrations will assist with hard-to-identify items. This manual is the authority to request/requisition replacement BII, based on TOE/MTOE authorization of the end item.

D-3. EXPLANATION OF COLUMNS.

The following provides an explanation of columns found in the tabular listings:

a. Column (1) - Illustration Number (Illus Number). This column indicates the number of the illustration in which the item is shown.

b. Column (2) - National Stock Number. Indicates the National Stock Number (NSN) assigned to the item and will be used for requisitioning purposes.

c. Column (3) - Description. Indicates the Federal item name and, if required, a minimum description to identify and locate the item. The last line of each item indicates the FSCM (in parentheses) followed by the part number.

d. Column (4) - Unit of Measure (U/M). Indicates the measure used in performing the actual operation or maintenance function. This measure is expressed by a two-character alphabetical abbreviation (ea, in., pr).

e. Column (5) - Quantity Required (Qty. Reqd). Indicates the quantity of the item authorized to be used with/on the equipment.

Section II. Components of End Item

Section III. Basic Issue Items

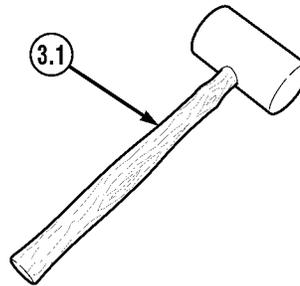
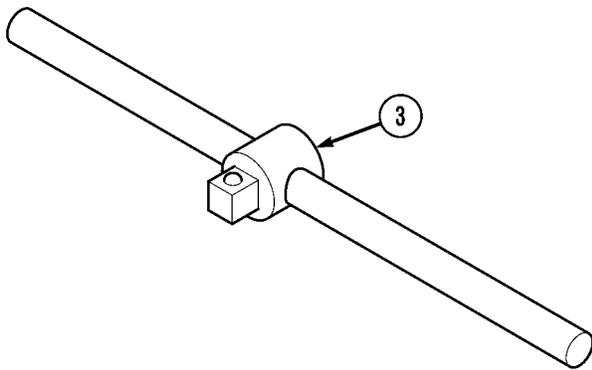
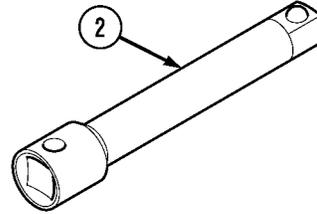
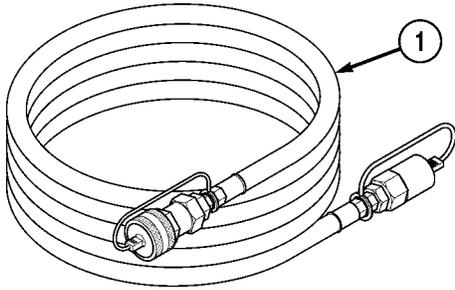

(1) Illus Number	(2) National Stock Number	(3) Description FSCM and Part Number	Usable On Code	(4) U/M	(5) Qty Reqd
0.1	5140-00-650-5103	BAR, PIN (19200) 12468755 (USED WITH CROP)		EA	1
1		CABLE, SLAVE (45152) 3294652		EA	1
1.1	2540-01-471-5071	EXTENSION, HOOK ARM (OBJH4) 12468660 (USED WITH CROP)		EA	1
2	5130-01-400-0129	EXTENSION, WRENCH (1CV05) 07569		EA	1
3	5120-00-709-4072	HANDLE, SLIDING (55719) L52BH		EA	1
3.1	5120-00-293-3396	HAMMER, WOODEN HANDLE, SOFT FACE (49181) KT171714 (USED WITH CROP)		EA	1

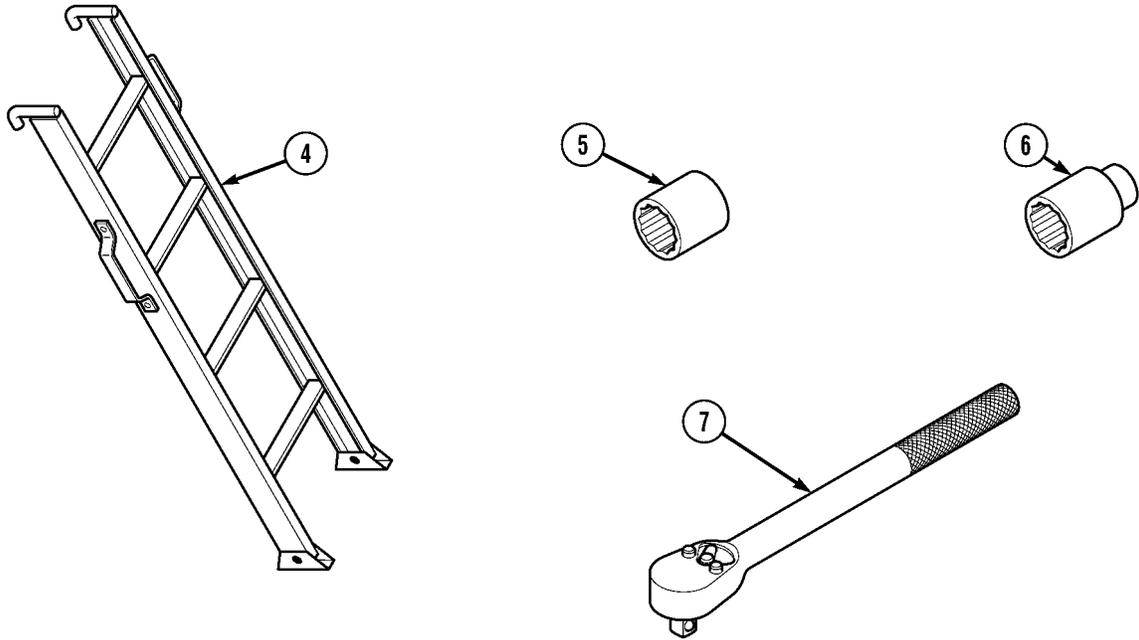

(1) Illus Number	(2) National Stock Number	(3) Description FSCM and Part Number	Usable On Code	(4) U/M	(5) Qty Reqd
4	5440-01-342-0700	LADDER (45152) 2019940		EA	1
5	5130-00-541-7839	SOCKET, 1-1/2 IN. (1DJ82) DP482TW		EA	1
6	5120-00-199-7771	SOCKET, 2-1/4 IN., 3/4 IN. DRIVE (82799) H1272 (USED WITH CROP)		EA	1
7	5120-00-249-1076	SOCKET WRENCH, 3/4 IN. DRIVE (77053) 9649 (USE WITH CROP)		EA	1

APPENDIX E

ADDITIONAL AUTHORIZED LIST

Section I. Introduction

E-1. SCOPE.

This appendix lists additional items that are authorized for the support of the M1120 series vehicles.

E-2. GENERAL.

This list identifies items that do not have to accompany the M1120 series vehicles and that do not have to be turned in with it. These items are all authorized for use by CTA, MTOE, TDA, or JTA.

E-3. EXPLANATION OF LISTING.

National Stock Numbers, description, and quantities are provided to help identify and request the additional items required to support this equipment. The items are listed in alphabetical sequence by item name under the type document (CTA, MTOE, TDA, or JTA) which authorizes the item(s) to you.

Section II. Additional Authorized List

APPENDIX F

EXPENDABLE/DURABLE SUPPLIES AND MATERIALS LIST

Section I. Introduction

F-1. SCOPE.

This appendix lists expendable supplies and materials you will need to operate and maintain the truck. These items are authorized to you by CTA50-970, Expendable Items (Except Medical, Class V, Repair Parts and Heraldic Items) or CRA8-100, Army Medical Department Expendable/Durable Items.

F-2. EXPLANATION OF COLUMNS.

- a. Column (1) - Item Number.** This number is assigned to the entry in the listing and is referenced in the narrative task box to identify the material (e.g., "Compound, Antiseize, Item 14, Appendix B").
- b. Column (2) - Level.** This indicates the level of maintenance authorized to use the material as approved by the Maintenance Allocation Chart (MAC).
- c. Column (3) - National Stock Number.** This is the National Stock Number assigned to the item; use it to request or requisition the item.
- d. Column (4) - Description.** Indicates the federal item name and, if required, a description to identify the item. The last line for each item indicates the Commercial and Government Entity (CAGE) code in parentheses followed by the part number.
- e. Column (5) - Unit of Measure (U/M).** Indicates the measure used in performing the actual maintenance function. This measure is expressed by a two-character alphabetical abbreviation (e.g., in., pr). If the unit of measure differs from the unit of issue, requisition the lowest unit of issue that will satisfy your requirements.

Section II. Expendable/Durable Supplies and Materials List

(1) Item Number	(2) Level	(3) National Stock Number	(4) Description	(5) U/M
1	O	8040-01-260-1939	Adhesive (71984) RTV 738 5 oz tube	oz
1.1		8040-01-321-1254 8040-01-363-0157	Adhesive (05972) Loctite #409 20 gm tube 200 gm tube	tu tu
2	O	6810-01-075-5546	Alcohol, Isopropyl (53390) 7618-19-4 40 oz bottle	oz
3	O	6840-00-300-6373 6840-01-173-6940	Biocide, Fuel Preservative (OU7J1) Biobar J.F. 1 quart 5 gallon	qt gl
4	O	5975-00-273-8133	Cable Ties (96906) MS3367-3	pk
5	O	7920-00-165-7195 7920-00-044-9281	Cloth, Cleaning (81349) MIL-C-85043 Type 1 - 10 lb box Type 2 - 10 lb box	lb lb
6	O	8030-01-087-8254 8030-00-155-6444	Compound, Antiseize (81399) MIL-A-907 8 ounce can with brush applicator 16 ounce aerosol can	oz oz
6.1	O	8030-00-251-3980	Compound, Antiseize (81349) MIL-A-907 1 lb. can	lb
7	O	8030-00-231-2340 8030-00-231-2344	Corrosion Preventive Compound (13548) 97940 8 ounce can 1 gallon can 5 gallon can	
7.1	O	8030-00-062-6950 8030-01-149-1731 8030-00-837-6557 8030-00-903-0931	Corrosion Preventive Compound (81349) MIL-C-16173 Grade 1 - 1 quart can Grade 2 - 1 quart can Grade 3 - 1 quart can Grade 4 - 1 quart can	qt qt qt qt
7.2	O	8040-00-092-2816	Epoxy (96900) 04001	ea

(1) Item Number	(2) Level	(3) National Stock Number	(4) Description	(5) U/M
8	O	9150-01-306-9202 9150-00-823-8047	Grease, General Purpose (81349) MIL-G-23549 1 pound can 35 pound can	lb lb
9	O		Heatshrink (45152) 1704950	ea
10	O	9250-00-186-6681 9150-00-188-9858 9150-00-189-6729	Lubricating Oil, Engine OD/HDO 30 (81349) MIL-L-2104 1 quart can 5 gallon can 55 gallon drum	qt gl gl
11	O	9150-01-293-7696 9150-01-293-2792	Lubricating Oil, Preservative (15W40) (Engine) (81349) MIL-L-21260C 5 gallon can 55 gallon drum	gl gl
12	O	9150-00-189-6727 9150-00-183-7807	Oil, Hydraulic OE/HDO 10 (81349) MIL-L-2104 1 quart can 55 gallon drum	qt gl
13	O	9150-00-250-0931 9150-00-250-0926 9150-00-250-0933	Petrolatum. Technical (81348) VV-P-236 8 ounce tube 1.75 pound can 7.5 pound can	oz lb lb
14	O	8030-01-054-0740 8030-00-204-9149 8030-01-166-0675	Sealing Compound (05972) Loctite #567 50 milliliter bottle 250 milliliter tube (05972) Loctite #567-47 50 milliliter tube	
15	O	8030-01-158-6060	Sealing Compound (05972) MIL-S-46163 Type 1 Grade K 10 milliliter bottle	bt
15.1		8030-01-303-0502 8030-01-387-2007	Sealing Compound (05972) Loctite #680 50 ml bottle 250 ml bottle	ml ml

(1) Item Number	(2) Level	(3) National Stock Number	(4) Description	(5) U/M
16	O	8030-01-104-5392 8030-01-014-5869 8030-01-025-1692	Sealing Compound (05972) Loctite #242 (80244) MIL-S-46163A Type 2 Grade N (45152) 079-820400 10 milliliter bottle 50 ml bottle 250 milliliter bottle	ml ml ml
17	O	8030-00-180-6150 8030-00-180-6222 8030-00-891-8358	Sealing Compound (05972) Loctite #609 (80244) MIL-R-46082B Type 1 10 milliliter bottle 50 milliliter bottle 250 milliliter bottle	bt bt bt
17.1	O	6850-00-177-5094	Silicone Compound (71984) Anti Corrosion DC4-20Z 2 ounce tube	oz
17.2	O	6810-00-252-1345	Solution, Soap (81349) MIL-W-15000 Class C	bt
18	O	6850-00-664-5685 6850-00-264-9038 6850-01-378-0679	Solvent, Drycleaning (81348) P-D-680 1 quart can 5 gallon can (Environmentally Compliant Solvent) (OK209) Breakthrough 5 gallon can	qt gl gl
19	O	9905-00-537-8957 9905-00-537-8955	Tags, Identification (81349) MIL-T-12755 White Yellow	ea ea
20	O	5970-00-547-0966	Tape, Electrical (19207) GISEALTYPE3	ea
21	O		Vapor Corrosion Inhibitor (44695) VCI 326 (81349) MIL-P-46002B 1 pint	pt
22	O		Vapor Corrosion Inhibitor (44695) VCI 329 (81349) MIL-P-46002B 1 pint	pt

APPENDIX G

STOWAGE AND SIGN GUIDE

Section I. Introduction

G-1. SCOPE.

This appendix shows locations for data plates, decals, and stencils that are required to be in place on the M1120 vehicles.

G-2. GENERAL.

The figures on the next pages show the location of metal signs, decals, and stencils used on the vehicle. Most of these signs and stencils contain cautions or information needed to operate the vehicle safely. For stowage locations of Components of End Items (COEI) and Basic Issue Items (BII), refer to Appendix D.

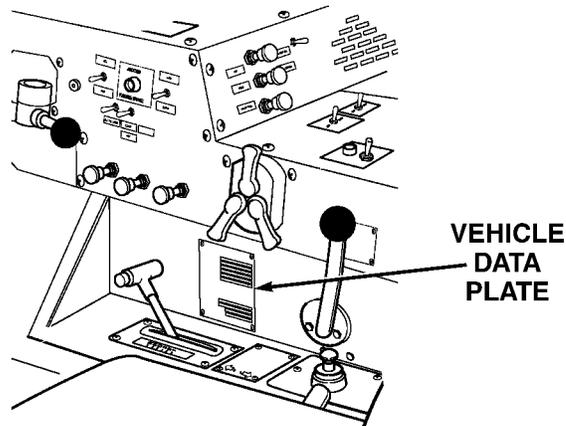
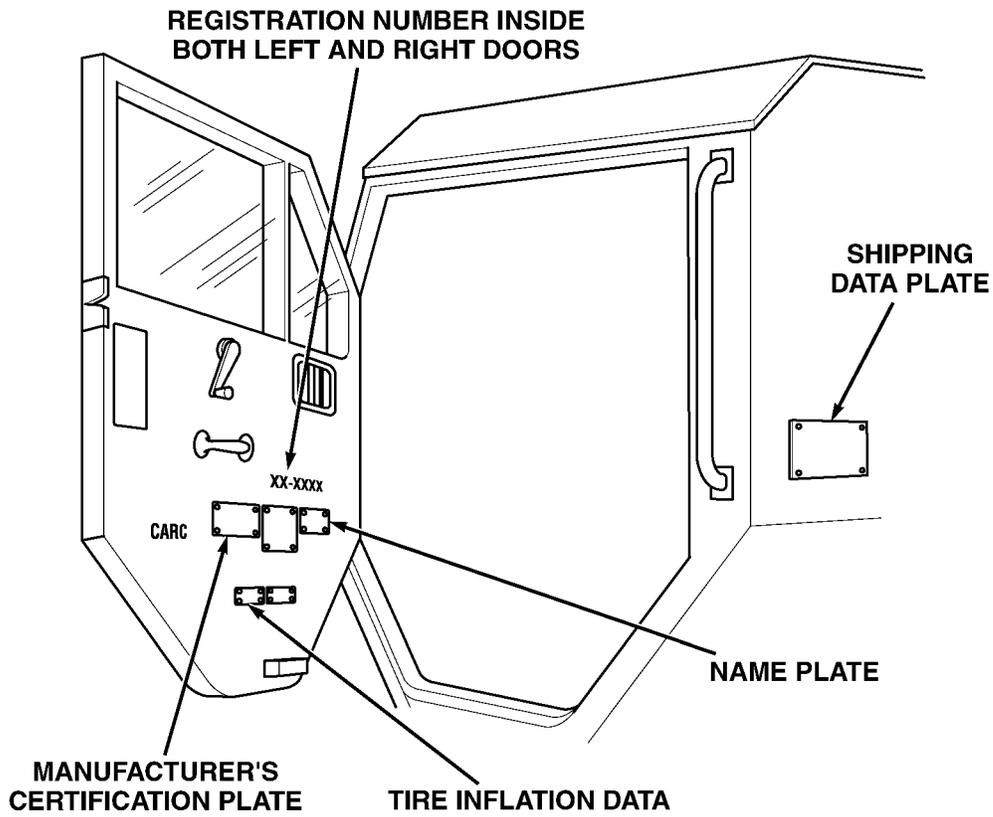

Section II. Stowage and Sign Guide

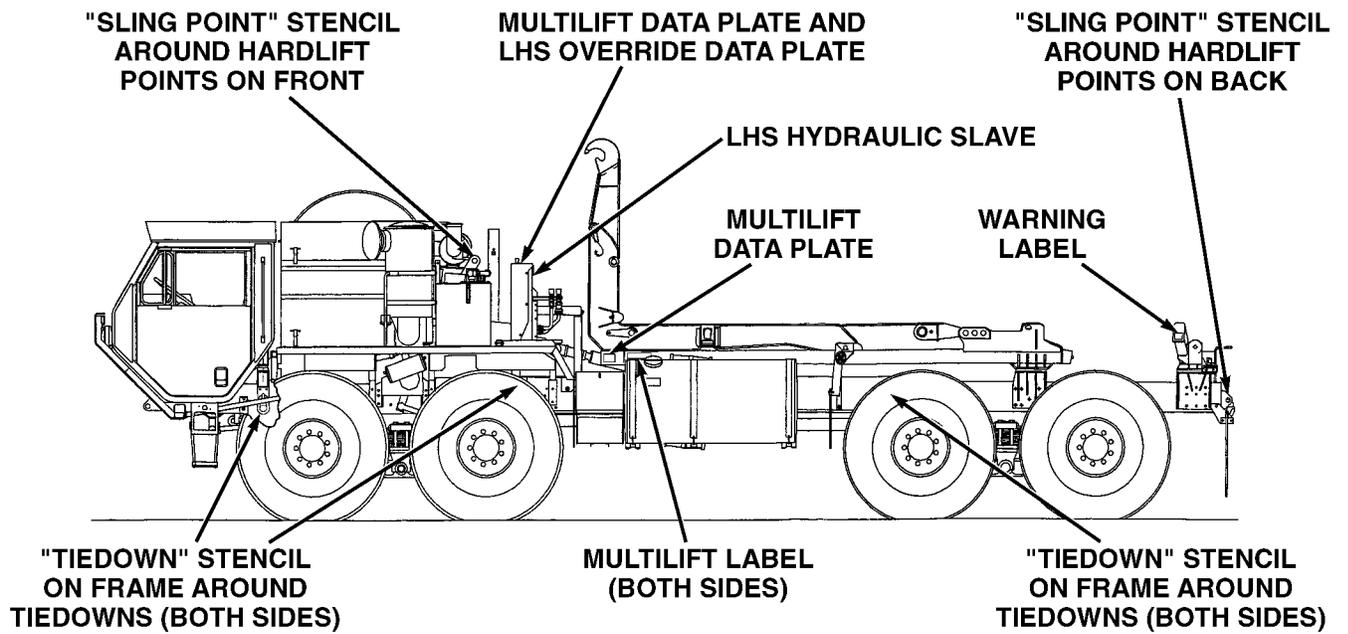
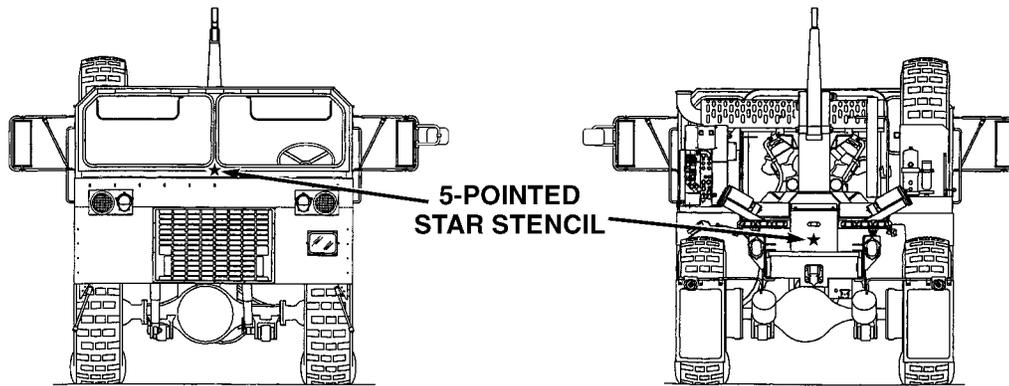

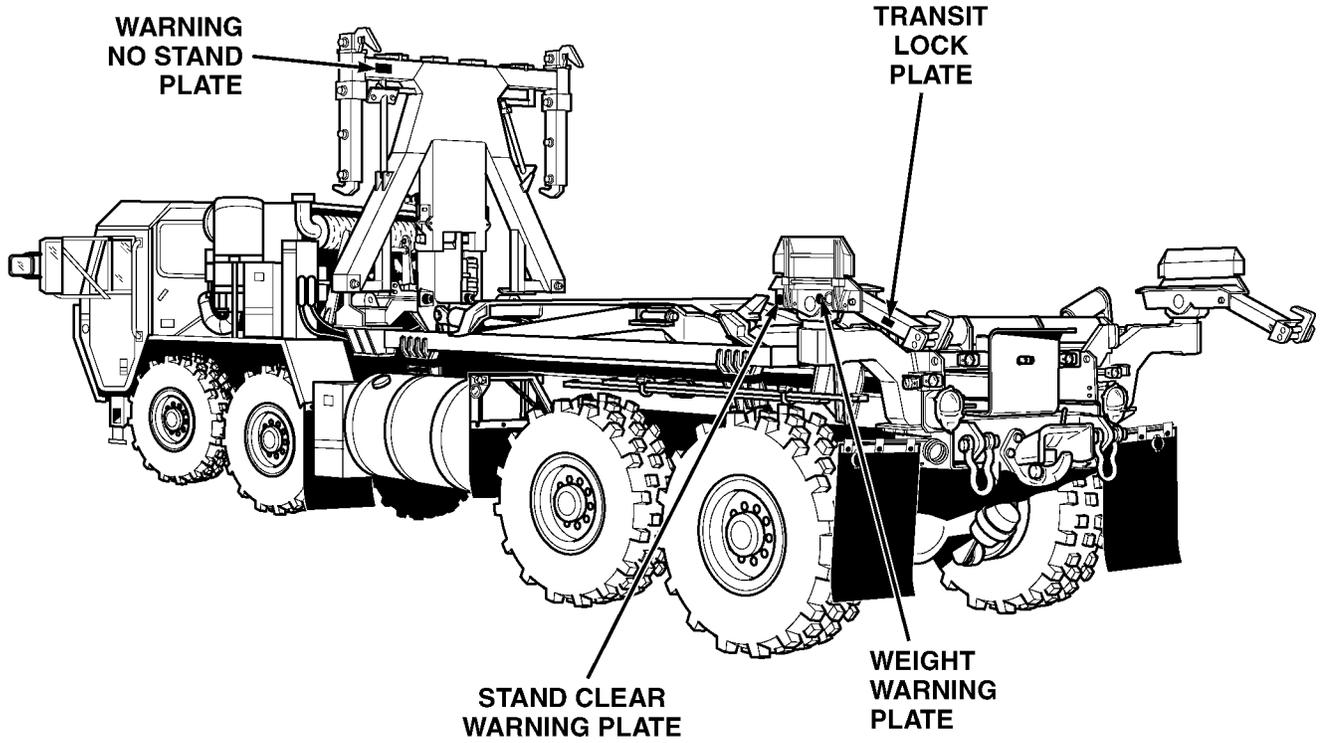

HEMTT LHS CHU

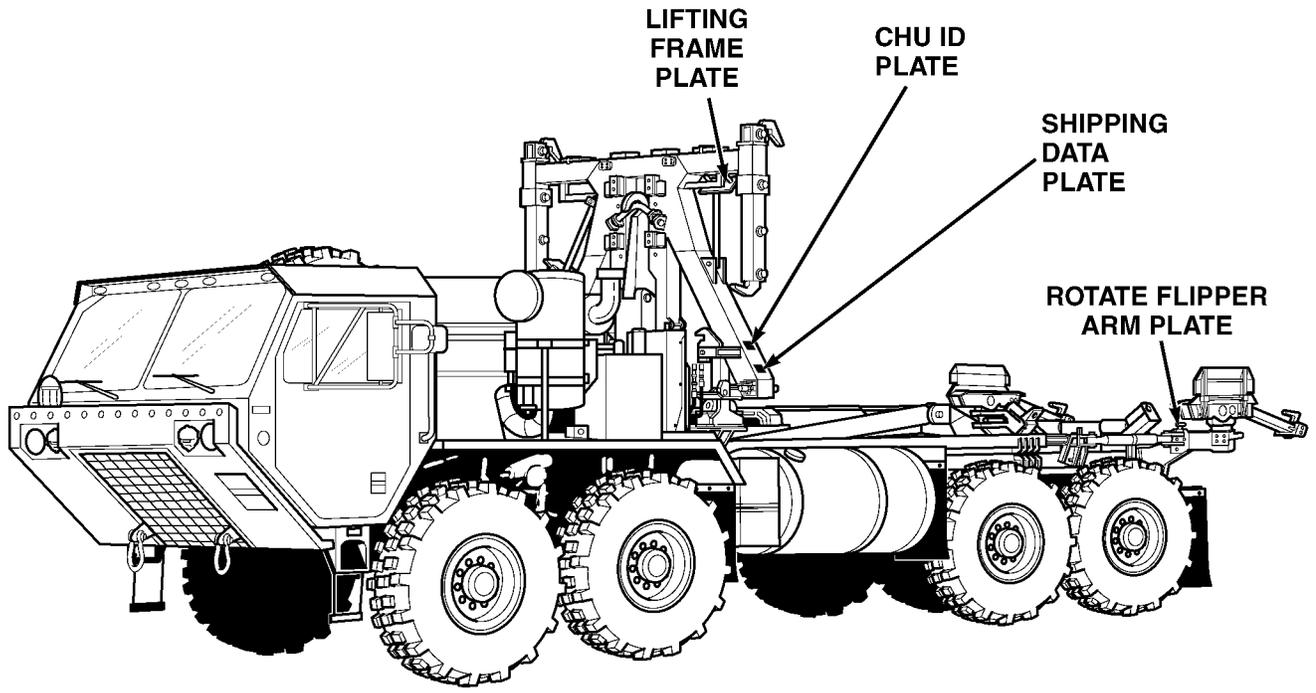

HEMTT LHS CHU

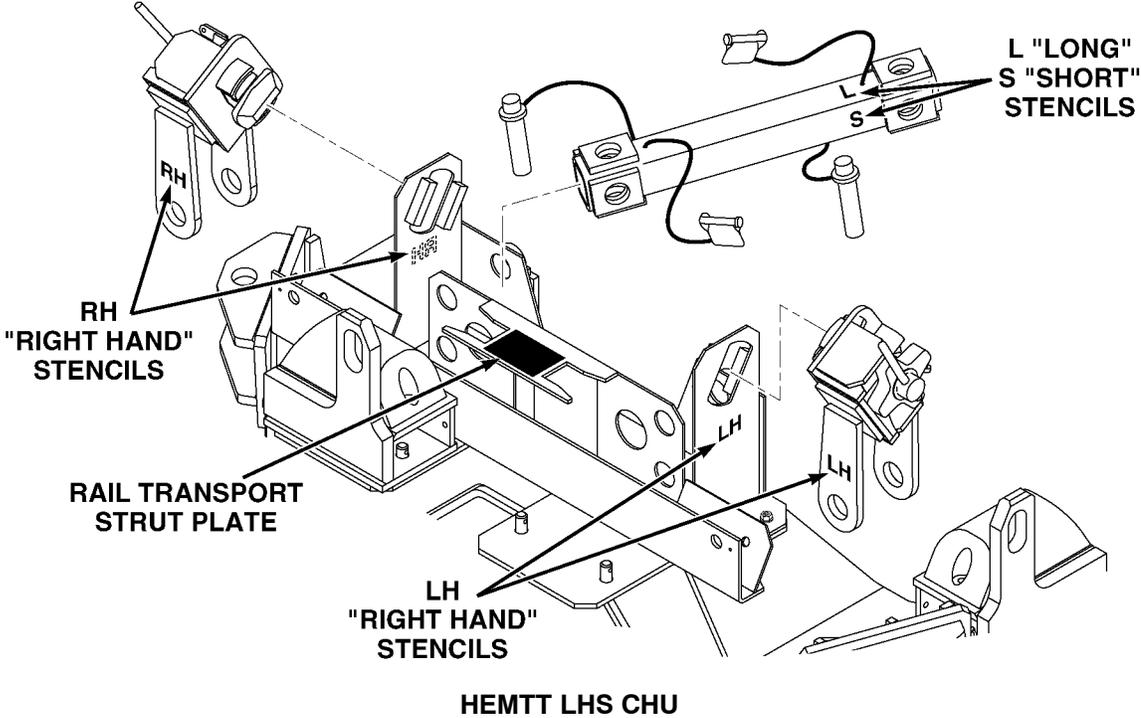

APPENDIX H ILLUSTRATED LIST OF MANUFACTURED ITEMS

This appendix includes complete instructions for manufacturing or fabricating authorized items locally. All bulk materials needed to manufacture an item are listed by part number or specification number in a tabular list with an illustration, as needed.

H-1. WOODEN BLOCKS.

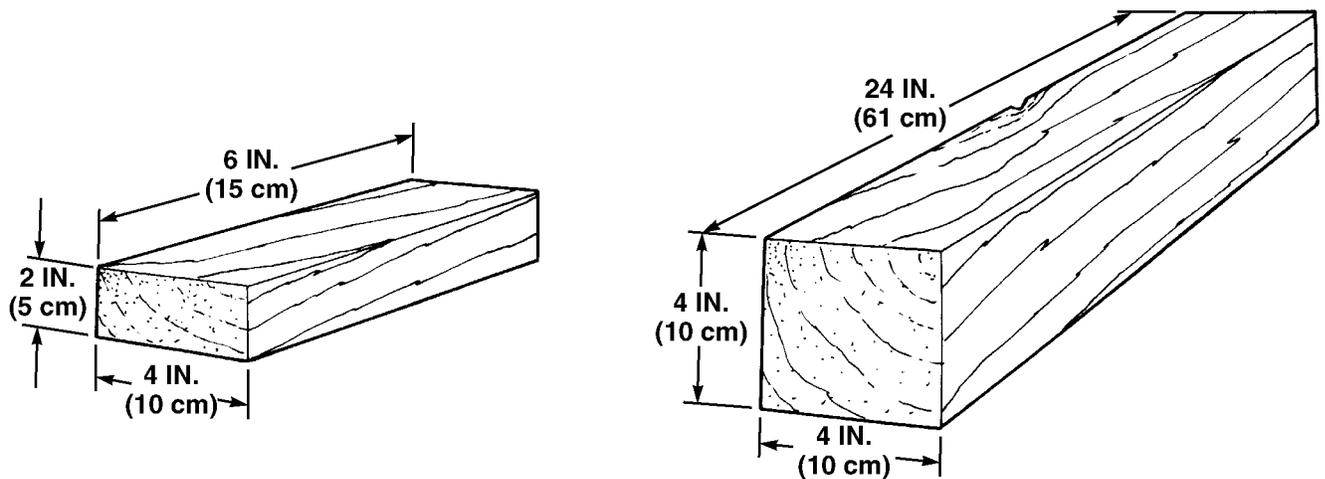

- a. Fabricate from MML751 lumber stock.
- b. Using saw and standard planing machine, cut stock to size required in Table H-1.

Table H-1. Wooden Blocks

Para Number	Finished Dimensions of Block In. (cm)	Qty
5-19	4 by 4 by 24 in. (10 by 10 by 61 cm)	2
5-23	4 by 4 by 24 in. (10 by 10 by 61 cm)	2
5-24	4 by 6 by 35 in. (10 by 15 by 89 cm)	2
5-25	2 by 4 by 6 in. (5 by 10 by 15 cm)	2
5-33	2 by 4 by 6 in. (5 by 10 by 15 cm)	2
5-36	4 by 6 by 35 in. (10 by 15 by 89 cm)	2
5-37	4 by 6 by 35 in. (10 by 15 by 89 cm)	2
5-38	1 by 2 by 6 in. (3 by 5 by 15 cm)	2
5-39	4 by 6 by 35 in. (10 by 15 by 89 cm)	2
5-40	4 by 4 by 24 in. (10 by 10 by 61 cm)	2

H-2. LHS BUSHING REMOVER/INSTALLER (SMALL).

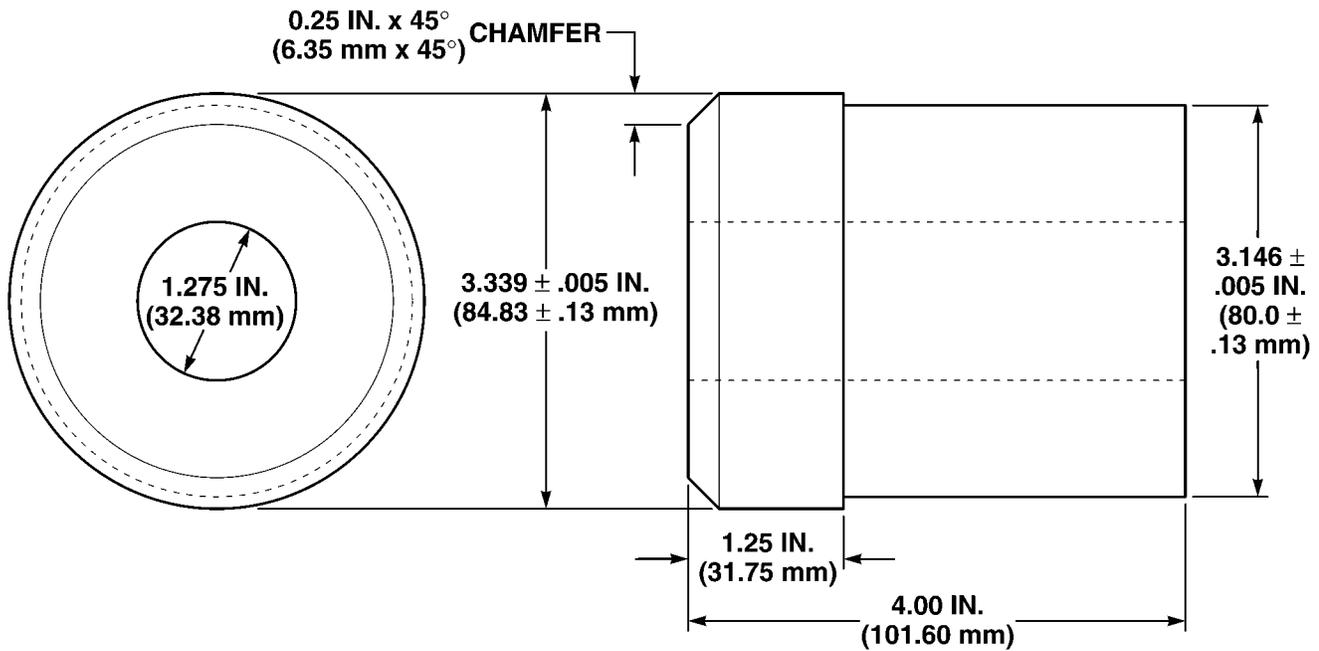

Fabricate large LHS bushing remover/installer from 4 in. (101 mm) x 3.339 in. diameter steel stock.

- a. Turn round stock to 3.339 in. ±.005 in.
- b. Cut a 1/4 in. (6 mm) x 45 degree chamfer where indicated.
- c. Drill through a 1.275 in. hole in the center of the 3.339 in. diameter steel stock where indicated.
- d. Starting at the end opposite of the chamfer, turn a length of 2.75 in. down to 3.146 in. ±.005 in. where indicated.
- e. Paint as required.

H-3. LHS BUSHING REMOVER/INSTALLER (LARGE).
--

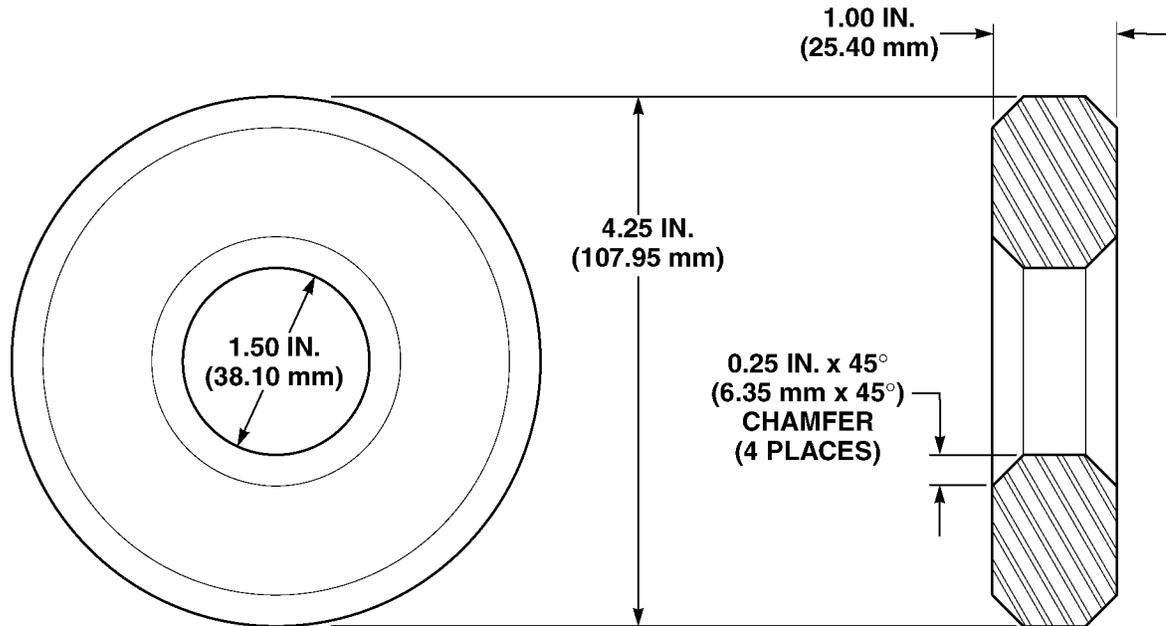

Fabricate small LHS bushing remover/installer from 1 in. (25 mm) x 4 1/4 in. (108 mm) diameter steel stock.

- a.** Drill through a 1 1/2 in. (38 mm) through steel stock where indicated.
- b.** Cut a 1/4 in. (6.35 mm) x 45 degree chamfer on both inside and outside diameters where indicated.
- c.** Paint as required.

H-4. LHS LEAD SCREW.

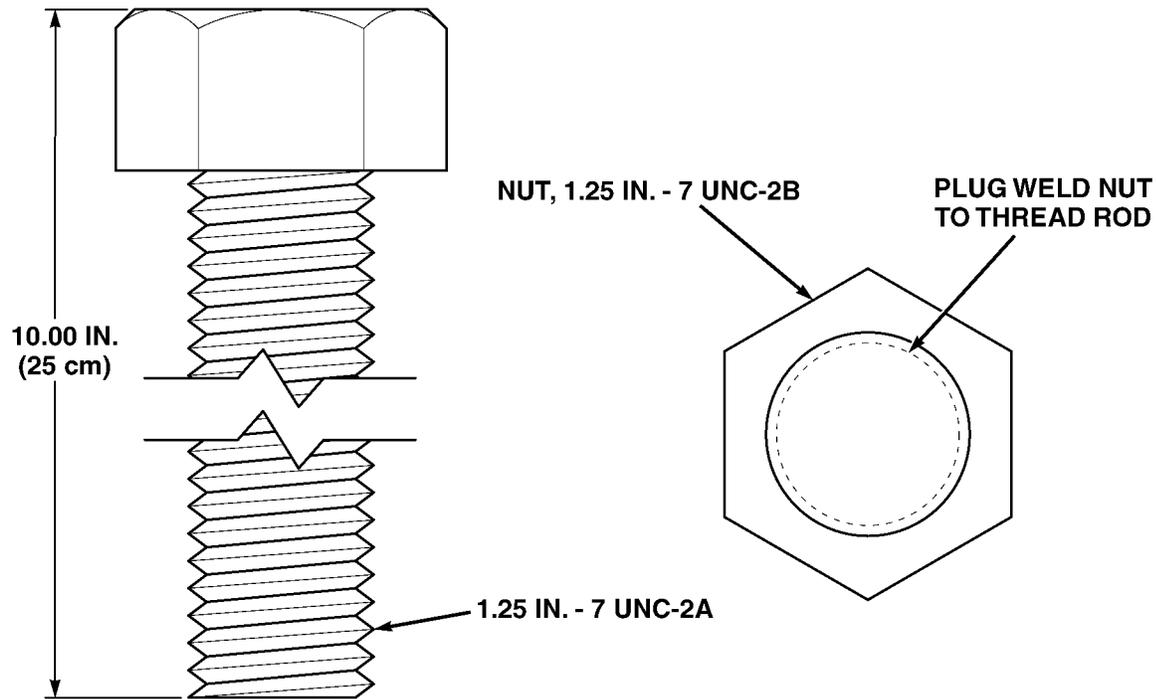

Fabricate LHS lead screw from grade 8 steel.

- a.** Cut length of thread rod to 9.750 in. (25 cm).
- b.** Thread nut on rod until total length measures 10.00 in. (25 cm).
- c.** Plug weld nut to thread rod.
- d.** Two grade 8 nuts are required, one loose and one welded.

H-5. LHS BUSHING REMOVER.

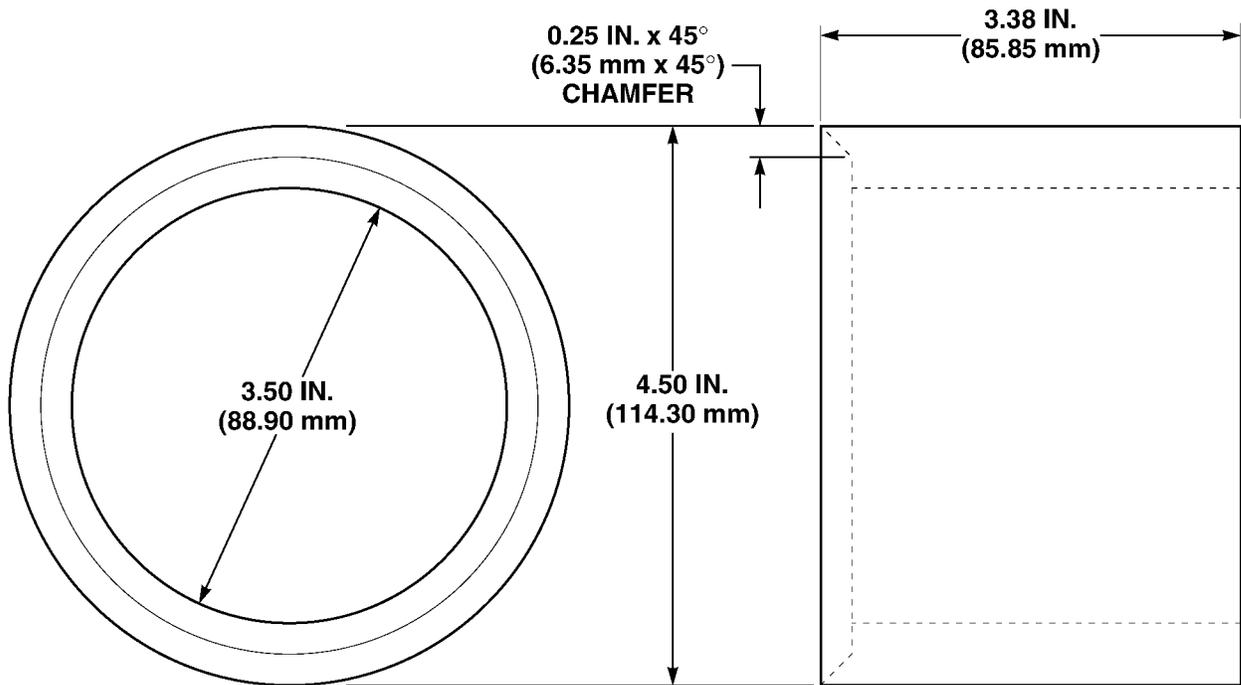

Fabricate LHS bushing remover from 3.38 in. (85.85 mm) x 4 1/2 in. (114 mm) diameter steel tubing.

- a.** Cut 4 1/2 in. (114 mm) outside diameter x 1/2 in. (13 mm) thick tubing to cut length of 3.38 in (85.85 mm).
- b.** Cut a 1/4 in. (6 mm) x 45 degree chamfer where indicated.
- c.** Paint as required.

H-6. LHS WASHER.

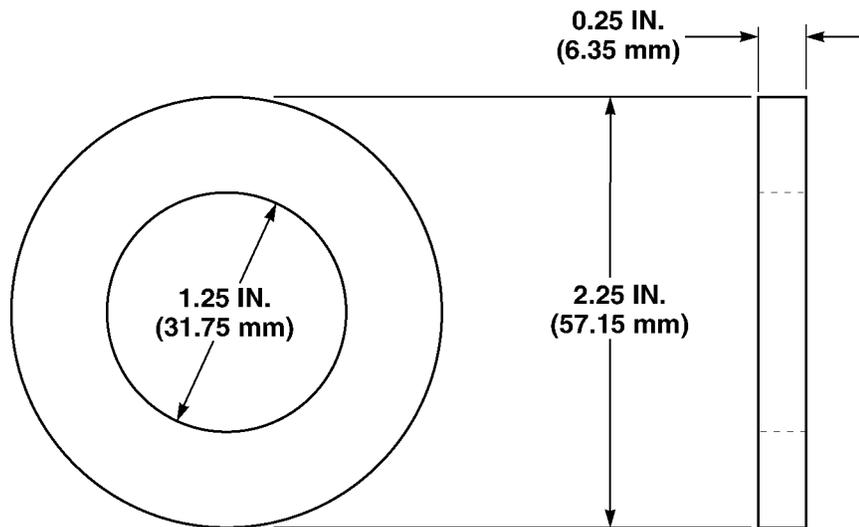

Fabricate LHS washer from 2 1/4 in. (57.15 mm) x 1/4 in. (6.35 mm) diameter steel stock.

- a. Drill 1 1/4 in. (31.75 mm) hole through steel stock where indicated.
- b. Paint as required.
- c. An alternate flat washer that may be used is part number MS51412-44.

APPENDIX J TORQUE LIMITS

Section I. Introduction

J-1. SCOPE.

This section provides general torque limits for the screws, hoses, and fittings used on the truck. Special torque limits are listed in the maintenance procedures for applicable components. The general torque limits given in this appendix shall be used when specific torque limits are not indicated in the maintenance procedure. These general torque limits cannot be applied to screws that retain rubber components. The rubber components will be damaged before the torque limit is reached. If a special torque limit is not given in the maintenance instructions, tighten the screw or nut until it touches the metal bracket then tighten it one more turn.

J-2. TORQUE LIMITS.

Table J-1 lists the torque limits for wet flange nuts. Table J-2 lists the torque limits for wet socket head cap screws. Table J-3 lists torque limits for dry fasteners. Dry torque limits are used on screws that do not have high pressure lubricants applied to the threads. Table J-4 lists torque limit for wet fasteners. Wet torque limits are used on screws that have high pressure lubricants applied to the threads. Table J-5 lists the torque limits for SAE 37 degree flare hose connections. Table J-6 lists the torque limits for SAE 45 degree flare hose connections. Table J-7 lists the torque limits of ORS preformed packing face seal hose connections. Table J-8 lists the torque limits for NPSM swivel connections.

J-3. HOW TO USE TORQUE TABLE.

a. Screws and Nuts.

- (1) Measure the diameter of the screw you are installing with a ruler.

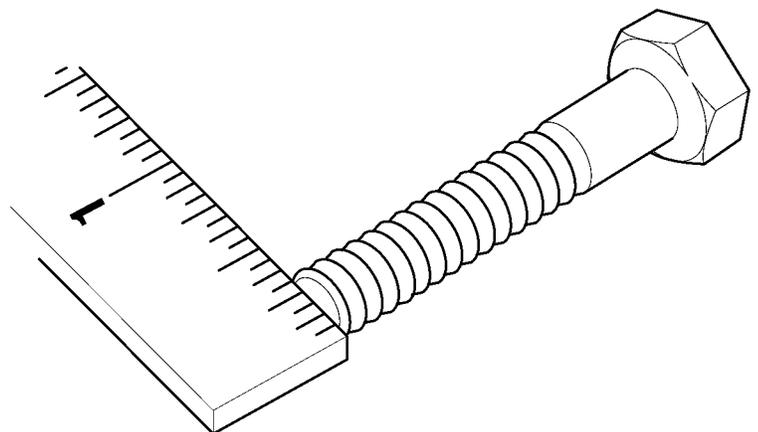

- (2) Measure out one inch with a ruler and count the number of threads per inch.
- (3) Under the heading SIZE, look down the left hand column until you find the diameter of the screw you are installing (there will usually be two lines beginning with the same size).
- (4) In the second column under SIZE, find the number of threads per inch that matches the number of threads per inch you counted in step (2). (Not required for metric screws).
- (5) To find the grade screw you are installing, match the markings on the head with the correct picture of CAPSCREW HEAD MARKINGS on the torque table.
- (6) Look down the column under the picture you found in step (5) until you find the torque limit (lb-ft. or N•m) for the diameter and threads per inch of the screw you are installing.
- (7) Use wet torque values.

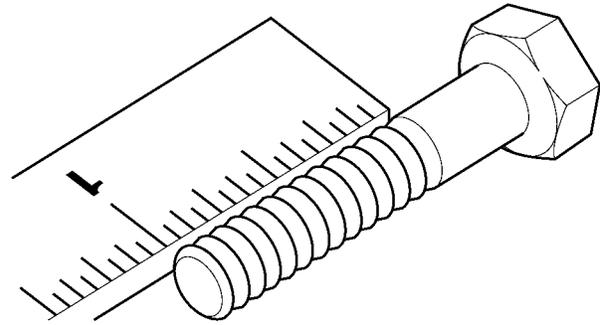

CAPSCREW HEAD MARKINGS

<p>Manufacturer's marks may vary. These are all SAE Grade 5 (3-line).</p> <p>STANDARD</p>	<p>Metric screws are of three grades: 8.8, 10.9, & 12.9. Manufacturer's marks & Grades appear on the screw head.</p> <p>METRIC</p>
--	---

Table J-1. Torque Limits For Wet Flange Nuts

SPIRALLOCK FLANGE NUT MARKINGS GRADE 8	DIAMETER		THREADS PER INCH	TORQUE	
	IN.	MM		LB-FT	N•m
	1/4	6.35	20	15	20
	5/16	7.94	18	25	34
	3/8	9.53	16	45	61
	1/2	12.70	13	110	149
	5/8	15.87	11	210	285
	3/4	19.05	10	375	508

Table J-2. Torque Limits For Wet Socket Head Cap Screws

SOC HEAD/12 PT.	TORQUE IN FT. LBS (CAP SCREWS) LUBED		
	SIZE	SOC HD OR 12 PT	SOC FLAT HD
	.10-24	55	2.5
	.25-20	12	6
	.31-18	25	12
	.38-16	44	22
	.50-13	70	36
	.56-12	106	53
	.62-11	212	106
	.75-10	375	187
	1.00-8	781	

b. Hoses and Fittings.

NOTE

Most fluid piping system sizes are measured by dash numbers. These are universally used abbreviations for the size of the component expressed as the numerator of the fraction with the denominator always being 16. For example, a -04 port is 4/16 or 1/4-inch. Dash numbers are usually nominal (in name only) and are abbreviations that make ordering of components easier.

- (1) Measure the I.D./O.D. diameter with a caliper as shown.

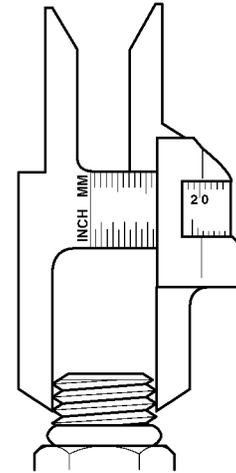

**O.D.
(MALE THREADS)**

- (2) Under the heading MALE THREAD O.D. and FEMALE THREAD I.D., match the measurements with the row in table to determine proper torque.

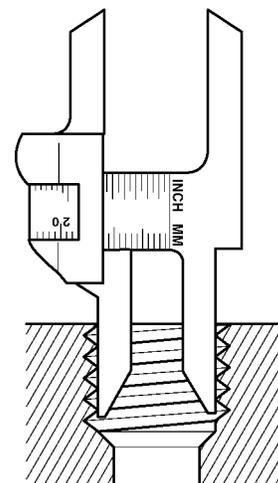

**I.D.
(FEMALE THREADS)**

- (3) To find the sealing surface angle, use a protractor and measure the sealing surface parallel to the centerline of the fitting.

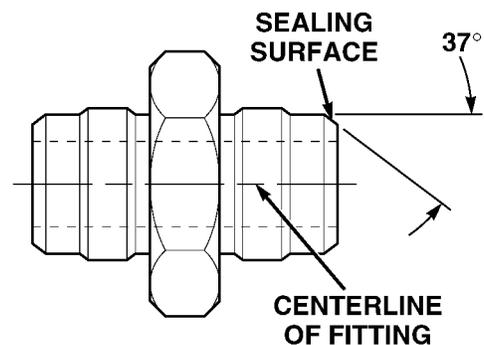
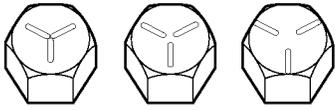

Table J-3. Torque Limits For Dry Fasteners

SIZE			TORQUE							
			SAE GRADE NO. 2		SAE GRADE NO. 5		SAE GRADE NO. 6 or 7		SAE GRADE NO. 8	
DIA. INCHES	THREADS PER INCH	MILLIMETERS	POUNDS FEET	NEWTON METERS	POUNDS FEET	POUNDS FEET	POUNDS FEET	POUNDS FEET	POUNDS FEET	POUNDS FEET
1/4	20	6.35	5	7	8	11	12	14	12	16
1/4	28	6.35	6	9	10	14	12	16	14	19
5/16	18	7.94	11	15	17	23	21	28	25	34
5/16	24	7.49	12	16	19	26	24	33	25	34
3/8	16	9.53	20	27	30	41	40	54	45	61
3/8	24	9.53	23	31	35	47	45	61	50	68
7/16	14	11.11	30	41	50	68	60	81	70	95
7/16	20		35	47	55	75	70	95	80	108
1/2	13	12.70	50	68	75	102	95	129	110	149
1/2	20		55	75	90	122	100	136	120	163
9/16	12	14.29	65	88	110	149	135	183	150	203
9/16	12		75	102	120	163	150	203	170	231
5/8	11	15.88	90	122	150	203	190	258	220	298
5/8	18		100	136	180	244	210	285	240	325
3/4	10	19.05	160	217	260	353	320	434	380	515
3/4	16		180	244	300	407	360	488	420	570
7/8	9	22.23	140	190	400	542	520	705	600	814
7/8	14		155	210	440	597	580	786	660	895
1	8	25.40	220	298	580	786	800	1085	900	1220
1	12		240	325	640	868	860	1166	1000	1356
1-1/8	7	25.58	300	407	800	1085	1120	1519	1280	1736
1-1/8	12		340	461	880	1193	1260	1709	1440	1953
1-1/4	7	31.75	420	570	1120	1519	1580	2142	1820	2468
1-1/4	12		460	624	1240	1681	1760	2387	2000	2712
1-3/8	6	34.93	560	759	1460	1980	2080	2080	2380	3227
1-3/8	12		640	868	1680	2278	2380	3227	2720	3688
1-1/2	6	38.10	740	1003	1940	2631	2780	3770	3160	4285
1-1/2	12		840	1139	2200	2983	3100	4204	3560	4827

CAPSCREW HEAD MARKINGS



Manufacturer's marks may vary. These are all SAE Grade 5 (3-line).

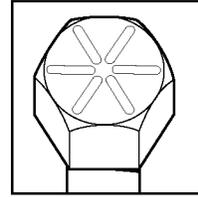
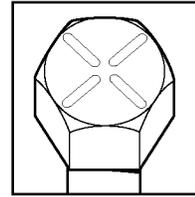
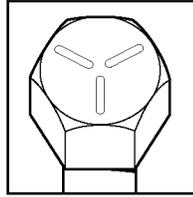
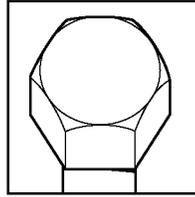
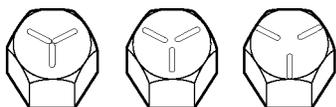

Table J-4. Torque Limits For Wet Fasteners

SIZE			TORQUE							
			SAE GRADE NO. 2		SAE GRADE NO. 5		SAE GRADE NO. 6 or 7		SAE GRADE NO. 8	
DIA. INCHES	THREADS PER INCH	MILLIMETERS	POUNDS FEET	NEWTON METERS	POUNDS FEET	POUNDS FEET	POUNDS FEET	POUNDS FEET	POUNDS FEET	POUNDS FEET
1/4	20	6.35	4	6	6	8	8	11	9	12
1/4	28	6.35	5	7	7	9	9	12	10	14
5/16	18	7.94	8	11	13	18	16	22	18	24
5/16	24	7.49	9	12	14	19	18	24	20	27
3/8	16	9.53	15	20	23	31	30	41	35	47
3/8	24	9.53	17	23	25	34	30	41	35	47
7/16	14	11.11	24	33	35	47	45	61	55	75
7/16	20		25	34	40	54	50	68	60	81
1/2	13	12.70	35	47	55	75	70	95	80	108
1/2	20		40	54	65	88	80	108	90	122
9/16	12	14.29	50	68	80	108	100	136	110	149
9/16	12		55	75	90	122	110	149	130	176
5/8	11	15.88	70	95	110	149	140	190	170	231
5/8	18		80	108	130	176	160	218	180	244
3/4	10	19.05	120	163	200	271	240	325	280	380
3/4	16		140	190	220	298	280	380	320	434
7/8	9	22.23	110	149	300	407	400	542	460	624
7/8	14		120	163	320	434	440	597	500	678
1	8	25.40	160	217	440	597	600	814	680	922
1	12		170	231	480	651	660	895	740	1003
1-1/8	7	25.58	220	298	600	814	840	1139	960	1320
1-1/8	12		260	353	660	895	940	1275	1080	1464
1-1/4	7	31.75	320	434	840	1139	1100	1492	1360	1844
1-1/4	12		360	488	920	1248	1320	1709	1500	2034
1-3/8	6	34.93	420	570	1100	1492	1560	2115	1780	2414
1-3/8	12		460	624	1260	1709	1780	2414	2040	2776
1-1/2	6	38.10	560	760	1460	1980	2080	2820	2360	3200
1-1/2	12		620	841	1640	2224	2320	3146	2660	3607

CAPSCREW HEAD MARKINGS



Manufacturer's marks may vary. These are all SAE Grade 5 (3-line).

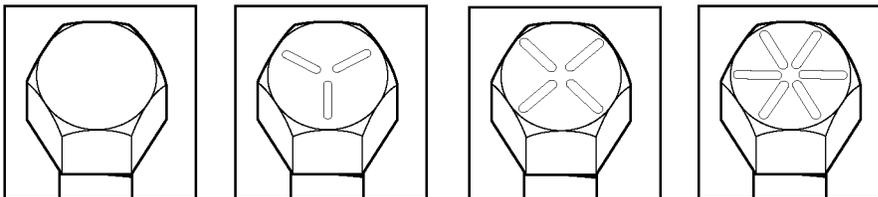
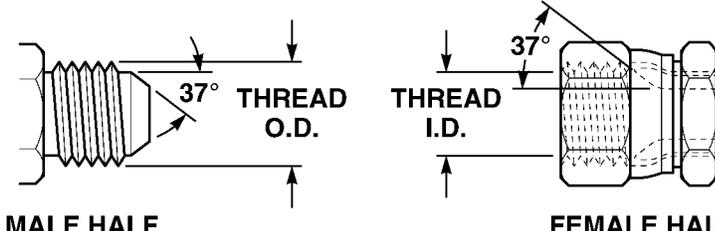
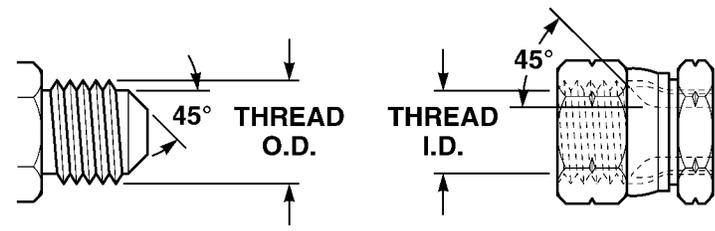

Table J-5. Torque Limits For 37-Degree Flare Hose Connections



INCH SIZE	DASH NO.	THREAD SIZE	TORQUE LB.FT.	TORQUE N•M
1/4	04	7/16-20	11-12	15-16
3/8	06	9/16-18	18-21	24-28
1/2	08	3/4-16	26-39	49-53
5/8	10	7/8-14	57-62	77-84
3/4	12	1 1/16-12	79-87	107-118
7/8	14	1 3/16-12	83-91	113-123
1	16	1 5/16-12	108-113	146-153
1 1/4	20	1 5/8-12	127-133	172-180
1 1/2	24	1 7/8-12	158-167	214-224
2	32	2 1/2-12	245-258	332-350

Table J-6. Torque Limits For 45-Degree Flare Hose Connections



INCH SIZE	DASH NO.	THREAD SIZE	TORQUE LB.FT.	TORQUE N•M
1/4	04	7/16-20	8-9	11-12
3/8	06	5/8-18	18-20	24-27
1/2	08	3/4-16	36-38	49-51
5/8	10	7/8-14	52-54	70-73
3/4	12	1 1/16-14	71-74	97-100

Table J-7. Torque Limits For ORS Preformed Packing Face Seal Hose Connections

				
INCH SIZE	DASH NO.	THREAD SIZE	TORQUE LB.FT.	TORQUE N•M
1/4	04	9/16-18	10-12	14-16
3/8	06	11/16-16	18-20	24-27
1/2	08	13/16-16	32-35	43-47
5/8	10	1-14	46-50	62-68
3/4	12	1 3/16-12	65-70	88-95
1	16	1 7/16-12	108-113	146-153
1 1/4	20	1 11/16-12	127-133	172-180
1 1/2	24	2-12	158-167	214-226

Table J-8. Torque Limits For NPSM Swivel Connections

				
INCH SIZE	DASH NO.	THREAD SIZE	TORQUE LB.FT.	TORQUE N•M
1/2	02	1/8-27	3-4	4-5
1/4	04	1/4-18	10-11	14-15
3/8	06	3/8-18	16-18	22-24
1/2	08	1/1-14	25-27	34-37
3/4	12	3/4-14	46-48	62-65
1	16	1-1 1/2	80-83	108-113
1 1/4	20	1 11/16-12	127-133	172-180
1 1/2	24	1 1/2-11/2	160-164	217-222
2	32	2-11/2	170-174	231-240

APPENDIX K MANDATORY REPLACEMENT PARTS

Section I. Introduction

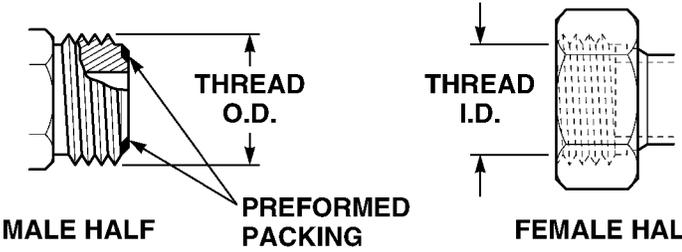
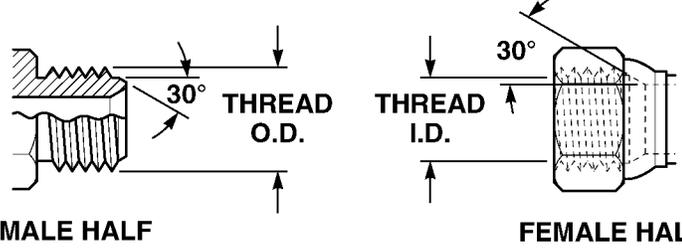
K-1. SCOPE.

This appendix lists all mandatory replacement parts required for performance of Organizational, Direct, and General Support Maintenance of LHS or M1120 trucks. It authorizes the requisitioning, issue, and disposition of consumable repair parts. All consumable repair parts listed in the maintenance task are listed here for ease of reference.

K-2. EXPLANATION OF COLUMNS (SECTION II).

- a. Column (1) - Index No.** This number is assigned to the entry in the listing and is referenced in the narrative task box to identify the part [e.g., Clamp (Item 12, Appendix K)].
- b. Column (2) - Nomenclature.** Indicates the federal item name and, if required, a description to identify the item.
- c. Column (3) - Part Number.** This is the vendor number assigned to the item.
- d. Column (4) - National Stock Number.** This is the National Stock Number assigned to the item; use it to request or requisition the item.

Section II. Mandatory Replacement Parts

Table K-1. Mandatory Replacement Parts

(1) Index No.	(2) Nomenclature	(3) Part Number	(4) National Stock Number
0.1	Insert, Thread	ALS7-1024-130	5325-01-395-0872
1	Locknut	110310A	5310-01-159-8178
1.1	Locknut	111316A	5306-01-106-7496
1.2	Locknut	115307A	5310-00-151-1036
2	Locknut	1333510	5310-01-340-5671
2.1	Locknut	110311A	5310-01-111-0645
3	Locknut	110312A	5310-01-150-5918
3.1	Locknut	1408910	5310-01-111-0645
3.2	Locknut	1437220	5310-01-288-1116
4	Locknut	1571850	5310-01-288-5096
5	Locknut	1598030	5310-01-342-8595
6	Locknut	1600460	5310-01-346-9445

(1) Index No.	(2) Nomenclature	(3) Part Number	(4) National Stock Number
7	Locknut	MS51922-9	5310-00-984-3806
8	Locknut	Z1NE-040	5310-01-066-6759
9	Locknut	MS51967-23	5310-00-763-8921
10	Locknut	N12	5310-00-185-6345
11	Locknut	T893R	5310-01-288-1116
12	Lockwasher	V75502830	5310-01-344-6738
13	Lockwasher	1937550	5310-01-355-8798
14	Lockwasher	2150HX1	5310-01-141-5565
14.1	Lockwasher	318BX	5310-01-061-5302
15	Lockwasher	351AX	5310-01-129-0450
16	Lockwasher	352A	5310-01-081-1283
17	Lockwasher	353A	5310-01-173-6716
17.1	Lockwasher	353AX	5310-00-582-5965
18	Lockwasher	354AX	5310-01-068-8446
19	Lockwasher	355AX	5310-01-133-2130
19.1	Lockwasher	371AX	5310-00-775-5139
20	Lockwasher	93613642	5310-01-068-8446
21	Lockwasher	MS35338-138	5310-00-933-8120
22	Lockwasher	MS35338-44	5310-00-582-5965
23	Lockwasher	W08	5310-01-355-8794
24	Lockwasher	W 12	5310-00-010-6265
24.1	Nut, Locking, Hex	1571850 (45152)	
25	Packing, Preformed	200-116-4490	5310-01-361-1505
26	Packing, Preformed	200-214-4490	5330-01-116-8112
27	Packing, Preformed	200-912-4490	5330-00-395-5737
28	Packing, Preformed	22617-12	5330-00-228-7196
29	Packing, Preformed	22617-16	5330-01-168-0885
30	Packing, Preformed	22617-8	5330-01-244-2273
30.1	Packing, Preformed	OR150	5310-01-463-1206
30.2	Packing, Preformed	OR155	5330-01-463-1210
31	Parts Kit, Seal	SK3-0002N-1	5330-01-357-7904
31.1	Pin, Cotter	1749HX	5315-01-459-7340
32	Pin, Cotter	MS24665-752	5315-00-546-4297
32.1	Pin, Roll	1840070	
32.2	Pin, Spring	3145955	
32.3	Plug, Hole	1798070	

(1) Index No.	(2) Nomenclature	(3) Part Number	(4) National Stock Number
33	Plug, Nylon	715001A	5340-01-372-3982
34	Preformed Packing Kit	9S000104	5330-01-363-0667
35	Preformed Packing Kit	9S-000105	5330-01-393-5075
36	Preformed Packing Kit	9S000106	5330-01-372-8377
37	Preformed Packing Kit	SK3-0017N-1	5330-01-357-7511
38	Preformed Packing Kit	SK3-0039N-1	5330-01-357-7510
39	Preformed Packing Kit	SK3-0024N1	5330-01-357-7512
40	Preformed Packing Kit	SK3-0088N-1	5330-01-355-9248
41	Ring, Retaining	MS16624-1315	5365-00-200-6684
41.1	Ring, Retaining	MS16624-1250	5365-00-806-2357
42	Screw	711053A	5305-01-355-2641
42.1	Screw, Self-Tapping		
43	Screw, Tapping	1324510	5305-01-157-5624
43.1	Seal, Plain	801000	5330-01-463-1204
44	Seal	1895210	5330-01-355-9269
45	Seal Kit	430457B	5330-01-394-3549
46	Washer, Spring	M12133/1-12P	5310-01-038-2294

INDEX

Subjects	Paragraph, Figure, Table Number
A	
Access Ladder, Use	2-12
Adjustment	
Load Handling System (LHS) Main Hydraulic Pressure	5-30
Main Frame Proximity Switch, Container Handling Unit (CHU)	4-37.2
Proximity Switch Replacement	
Container Handling Unit (CHU)	4-37.1
(Hook Arm Down)	4-35
(Hook Arm Up)	4-36
(Main Frame Down)	4-37
Rear Lock Limit Switch, Container Handling Unit (CHU)	4-45.1
Sensing Plate, Container Handling Unit (CHU)	4-37.1
Alarm, Reverse, Replacement	4-44
Assembly, General Instructions	4-25
	5-14
B	
Bracket, Bumper Stop Stinger, Replacement	4-49
Bushing	
Installer	
LHS, (Large)	H-3
LHS, (Small)	H-2
LHS, Remover	H-5
Remover	
LHS, (Large)	H-3
LHS, (Small)	H-2
C	
Capabilites, Equipment Characteristics and Features	4-7
	1-9
Characteristics, Equipment, Capabilities and Features	4-7
	1-9
Check Valve, Load Handling System (LHS), Replacement	5-42
Checks, Preventive Maintenance and Services	2-5
Clean Vehicle	3-5
Cleaning, General Instructions	4-22
	5-11
Clearance Light, Replacement	4-42
Cold Environment, Extreme, Operate Vehicle (-26°F [-32°C] to -50°F [-46°C])	2-13
Components	
Major, Location and Description	4-8
	1-10
Compression Frame, Load Handling System (LHS) Repair	5-26
Configuring for	
Air/Sea Transport	2-11
Over-the-Road Operations	2-10

INDEX (CONT)

Subjects	Paragraph, Figure, Table Number
C (cont)	
Container	
Lift Out of Mud	2-10.7
(48 Inches), Loading, Unloading	2-10.5
(51 Inches), Loading, Unloading	2-10.4
(72 Inches), Loading, Unloading	2-10.3
(82 Inches), Loading, Unloading	2-10.2
Container Guide, Container Handling Unit (CHU), Repair, Adjustment	4-53.1
Container Handling Unit (CHU)	2-10.1
Container Guide, Repair, Adjustment	4-53.1
Control Box	
Repair	4-34.3
Assembly, Replacement	4-34.1
Wiring, Replacement	4-34.2
Fault Index	T 4-2.1
Front	
Crossmember Assembly, Replacement	4-53.13
Lift Adapter	
Assembly, Replacement	4-53.8
Flipper Bracket, Repair	4-53.13
Locking Plate Assembly, Replacement	4-53.9
Lower Container Lock Plate, Repair	4-53.11
Support Brackets, Replacement	4-53.15
Jumperwire Harness, Replacement	4-33.1
Kit Installation	5-43
Lock Plate, Repair	4-53.13
Long Strut Bracket Assembly, Repair	4-53.6
Main Frame Proximity Switch, Replacement/Adjustment	4-37.2
Proximity Switch, Replacement/Adjustment	4-37.1
Rear	
Rear Bracket Assembly, Replacement	4-53.5
Light Bar Assembly, Replacement	4-43.1
Lock Limit Switch, Replacement/Adjustment	4-45.1
Sensing Plate, Replacement/Adjustment	4-37.1
Self-Recovery Winch (SRW), Rear Guide, Replacement	4-53.10
Short Strut and Pin Bracket Assembly, Repair	4-53.4
Simplified, Operation	2-10.12
Slider	
Arm Assembly, Repair	5-28.1
Wear Plate, Replacement	4-53.3
Slider/Pivot Assembly, Repair	4-53.2
Stowage Tray, Replacement	4-53.7
Wear Pad, Replacement	4-53.16
Wire Harness, Replacement	4-33.2
Controls and Indicators Introduction	2-1

INDEX (CONT)

Subjects	Paragraph, Figure, Table Number
C (cont)	
Control Box	
Container Handling Unit (CHU), Repair	4-34.3
Assembly, Container Handling Unit (CHU), Replacement	4-34.1
Wiring, Container Handling Unit (CHU), Replacement	4-34.2
Controls, LHS	F 2-1
D	
Data Plate Replacement	4-52
Deficiency, Submitting Quality, Reports (QDR)	1-5
Deck Assembly, Replacement	4-53
Description, Location, Major Components	1-10
	4-8
Destruction, Army Material to Prevent Enemy Use	4-3
Direct Support	
Troubleshooting Procedures	5-7
	T 5-2
Directional Control Valve, Load Handling System (LHS), Replacement	5-35
Disassembly	
General Instructions	5-10
	4-21
Distribution Box Replacement, Load Handling System (LHS)	4-34
E	
EIR, Reporting Equipment Improvement Recommendations	4-6
EIR MD, Equipment Improvement Report and Maintenance Digest	1-3
EIR MS, Equipment Improvement Report and Maintenance Summary	1-3
Electrical System, Overview	4-29
Emergency Procedures	2-14
Environment, Operate Vehicle in Extreme Cold (-26°F [-32°C] to -50°F [-46°C])	2-13
Equipment	
Characteristics, Capabilities, and Features	4-7
Common Tools	5-1
Support, Special Tools, TMDE	5-2
	4-4
Equipment Characteristics, Capabilities, and Features	1-9
	4-7
Equipment Data	4-9
	1-11
	T 1-1
Equipment Improvement Report and Maintenance Digest (EIR MD) and Equipment Improvement Report and Maintenance Summary (EIR MS)	1-3

INDEX (CONT)

Subjects	Paragraph, Figure, Table Number
F	
Fault Index	
Container Handling Unit (CHU)	T 4-2.1
Load Handling System	T 4-2
	T 5-1
Fault Symptom Index	T 3-1
Features	
Equipment Characteristics, Capabilities	1-9
of Equipment	4-7
Fender, Rear, Replacement	4-50
Field Manuals	A-3
Flats Rotation, Recommended	T 4-4
	T 5-3
Fluid, Leakage	4-15
Forms	
Maintenance and Records	2-4
Maintenance Records	1-2
Maintenance, Records, and Reports	4-2
Front	
Crossmember Assembly, Container Handling Unit (CHU), Replacement	4-53.14
Lift Adapter	
Assembly, Container Handling Unit (CHU), Replacement	4-53.8
Flipper Bracket, Container Handling Unit (CHU), Repair	4-53.13
Locking Plate Assembly, Container Handling Unit (CHU), Replacement	4-53.9
Lower Container Lock	
Plate, Container Handling Unit (CHU), Repair	4-53.11
Repair	4-53.12
Repair	
Lower Container Lock	4-53.12
from Truck, Install/Remove	2-10.11
G	
General Instructions	
Assembly	4-25
	5-14
Cleaning	4-22
	5-11
Disassembly	4-21
	5-10
Inspection	4-23
	5-12
Installation	4-26
	5-15
Removal	4-20
	5-9
Repair	4-24
	5-13
General Maintenance Procedures	2-6

INDEX (CONT)

Subjects	Paragraph, Figure, Table Number
G (cont)	
General Support Troubleshooting Procedures	5-7
	T 5-2
H	
Hand Receipt (HR) Manuals	1-4
HEMTT Load Handling System Vehicle	F 1-1
Hook, Load Handling System (LHS), Replacement	5-22
Hook Arm	
Load Handling System (LHS), Repair	5-23
Cylinder, Load Handling System (LHS), Replacement	5-37
Manifold, Load Handling System (LHS), Repair	5-36
Main Frame Cylinder, Load Handling System (LHS), Repair	5-38
Hose, Hydraulic, Replacement	4-58
Housing	
Hydraulic Filter, Replacement	4-57
Pilot Light, Replacement	4-32
HR, Hand Receipt Manuals	1-4
Hydraulic	
Filter and Housing Replacement	4-57
Hose Replacement	4-58
Selector Switch Replacement	4-31
System, Overview	4-55
	5-29
Hydraulic Lines - M1120 Vehicle	F 4-2
I	
Indicators	
Controls Introduction	2-1
Instrument Panel Controls	2-2
Indicators, LHS	F 2-1
Inspection	
General Instructions	4-23
	5-12
Upon Receipt	
Inspection	5-4
Instructions	4-11
Install, Front Lift Adapter from Truck	2-10.11
Installation, General Instructions	4-26
	5-15
Instrument Panel Controls and Indicators	2-2
ISO Container, Loading/Unloading, M3 CROP	2-10.9
J	
Jumperwire Harness, Container Handling Unit (CHU), Replacement	4-33.1
Junction Box, LHS, Replacement	4-41

INDEX (CONT)

Subjects	Paragraph, Figure, Table Number
K	
■ Kit Installation, Container Handling Unit (CHU)	5-43
L	
Ladder	
Access, Use	2-12
■ Bracket, Replacement	4-51.1
Lead Screw, LHS	H-4
Leakage	
Fluid	4-15
Classification and Definition	2-7
LHS	
Circuit Breaker Replacement	4-33
Controls and Indicators	F 2-1
Junction Box Replacement	4-41
Main Wire Harness Replacement	5-19
Maintenance Introduction	5-8
Rubber Bumper, Replacement	5-21
Troubleshooting	4-17
.....	5-5
■ Lifting Frame, Transport with HEMTT LHS Without Container	2-10.6
Light Bar Assembly, Rear, Replacement	4-43
Load Classification	T 1-2
Load Control Valve Main Frame, Load Handling System (LHS), Replacement	5-41
Loading	
Container (48 Inches)	2-10.5
Container (51 Inches)	2-10.4
Container (72 Inches)	2-10.3
Container (82 Inches)	2-10.2
ISO Container, M3 CROP	2-10.9
M3 CROP on Trailer	2-10.8
Load Handling System (LHS)	1-13
.....	2-9
Check Valve, Replacement	5-42
Directional Control Valve, Replacement	5-35
Distribution Box Replacement	4-34
Fault Index	T 4-2
.....	T 5-2
Hook Arm	
Cylinder, Replacement	5-37
Manifold, Repair	5-36
Repair	5-23
Hook, Replacement	5-22
Load Control Valve Main Frame, Replacement	5-41
Main Cylinder	
Manifold, Repair	5-39
Replacement	5-40

INDEX (CONT)

Subjects	Paragraph, Figure, Table Number
L (cont)	
Load Handling System (LHS) (cont)	
Main Frame	
Nose Support, Replacement	5-28
Tube, Replacement	5-25
Repair	5-24
Main Hydraulic Pressure, Adjustment	5-30
Main Manifold	
Relief Valve, Replacement	5-33
Solenoid Valve and Coil, Repair	5-34
Bracket, Replacement	5-31
Maintenance Introduction	5-8
Mounting Bracket Replacement	5-27
Rear Roller Assembly Mounting Bracket, Replacement	5-27.1
Rectifier, Replacement	4-40
Transit Valve, Replacement	5-32
Troubleshooting	4-17
	T 4-3
	5-5
Location and Description of Major Components	1-10
	4-8
Lockout Relay, Main Frame, Replacement	4-38
Lock Plate, Container Handling Unit (CHU), Repair	4-53.13
Long Strut Bracket Assembly, Container Handling Unit (CHU), Repair	4-53.6
Lower Container Lock	
Front Lift Adapter	
Repair	4-53.12
Repair	
Front Lift Adapter	4-53.12
Lowering Button, Safe, Replacement	4-39
Lubricant, Maintaining, Levels	3-1
Lubrication	
General Instructions	3-2
Points	F 3-1
M	
M3 CROP	
Loading/Unloading, ISO Container	2-10.9
Stacking/Loading, Trailer	2-10.8
Main Frame Cylinder	
Load Handling System (LHS), Replacement	5-40
Manifold, Load Handling System (LHS), Repair	5-39
Main Frame	
Load Handling System (LHS), Repair	5-24
Lockout Relay Replacement	4-38
Nose Support, Load Handling System (LHS)Replacement	5-28
Proximity Switch, Container Handling Unit (CHU), Replacement/Adjustment	4-37.2
Tube, Load Handling System (LHS), Replacement	5-25
Main Hydraulic Pressure, Load Handling System (LHS), Adjustment	5-30

INDEX (CONT)

Subjects	Paragraph, Figure, Table Number
M (cont)	
Main Manifold	
Relief Valve, Load Handling System (LHS), Replacement	5-33
Solenoid Valve and Coil, Load Handling System (LHS), Repair	5-34
Bracket, Load Handling System (LHS) , Replacement	5-31
Main Wire Harness, Load Handling System (LHS), Replacement	5-19
Maintenance	
Introduction	4-19
Introduction, Load Handling System (LHS)	5-8
Lubricant Levels	3-1
Storage, Procedures	5-18
Maintenance Forms and Records	1-2
	2-4
Maintenance Forms, Records, and Reports	4-2
Maintenance Introduction	3-4
Maintenance Procedures, General	2-6
	4-13
Mandatory Replacement Parts	T K-1
Marker Light Replacement	4-42
Metric System	1-7
Miscellaneous Publications	A-5
Mounting Bracket, Load Handling System (LHS), Replacement	5-27
Mud Flap, Center, Replacement	4-51
O	
Operate Vehicle in Extreme Cold Environment (-26°F [-32°C] to -50°F [-46°C])	2-13
Operation, Container Handling Unit (CHU) Simplified	2-10.12
Operation, Principals	4-56
Operations, Configuring for Over-the-Road	2-10
Operator's, Preventive Maintenance Checks and Services	
After	T 2-2
Before	T 2-1
Operator/Crew Preventive Maintenance Checks and Services Tables	2-8
Over-the-Road, Configuring, Operations	2-10
Overview	4-10
Electrical System	4-29
Load Handling System	4-54
P	
Parts, Repair	4-5
Pilot Light, Housing, Replacement	4-32
Pin Bracket, Container Handling Unit (CHU), Repair	4-53.4
Pivot Assembly, Container Handling Unit (CHU), Repair	4-53.2
PMCS	
Introduction	4-14
	2-3
Table	4-16
Unit Level Preventive Maintenance Checks and Services	T 4-1

INDEX (CONT)

Subjects	Paragraph, Figure, Table Number
P (cont)	
Preparation for Storage or Shipment	4-28
Instructions	4-27
Introduction	5-16
Preventive Maintenance Checks and Services Tables, Operator/Crew	2-8
Preventive Maintenance Checks and Services	2-5
Introduction	4-14
Operator's, After	T 2-2
Operator's, Before	T 2-1
Unit Level	T 4-1
Procedures, Emergency	2-14
Proximity Switch	
Container Handling Unit (CHU), Replacement/Adjustment	4-37.1
Replacement/Adjustment	
(Hook Arm Down)	4-35
(Hook Arm Up)	4-36
(Main Frame Down)	4-37
Wire Positions	T 4-5
Q	
QDR, Submitting Quality Deficiency Reports	1-5
Quality Deficiency Reports (QDR), Submitting	1-5
R	
Rail, Transport	2-10.12
Rear	
Bracket Assembly, Container Handling Unit (CHU), Replacement	4-53.5
Guide, Replacement, Container Handling Unit (CHU), Self-Recovery Winch (SRW) ..	4-53.10
Light Bar Assembly, Container Handling Unit (CHU), Replacement	4-43.1
Lock Limit Switch, Container Handling Unit (CHU), Replacement/Adjustment	4-45.1
Roller Assembly Mounting Bracket, Load Handling System (LHS), Replacement	5-27.1
Records	
Maintenance Forms	2-4
	1-2
Maintenance, Forms, and Reports	4-2
Rectifier, Load Handling System (LHS), Replacement	4-40
Reference Information	1-8
Removal	
General Instructions	5-9
	4-20
Remove, Front Lift Adapter from Truck	2-10.11
Remover, LHS Bushing	H-5
Repair	
Compression Frame, Load Handling System (LHS)	5-26
Container Guide, Container Handling Unit (CHU)	4-53.1
Control Box, Container Handling Unit (CHU)	4-34.3

INDEX (CONT)

Subjects	Paragraph, Figure, Table Number
R (cont)	
Repair (cont)	
Front Lift Adapter	
Flapper Bracket, Container Handling Unit (CHU)	4-53.13
Lower Container Lock	4-53.12
Lower Container Lock Plate, Container Handling Unit (CHU)	4-53.11
General Instructions	4-53.11
	5-13
General Wire Harness	4-30
Load Handling System (LHS)	
Hook Arm	5-23
Hook Arm Manifold	5-36
Hook Arm/Main Frame Cylinder	5-38
Main Cylinder Manifold	5-39
Main Frame	5-24
Main Manifold Solenoid Valve and Coil	5-34
Lock Plate, Container Handling Unit (CHU)	4-53.13
Long Strut Bracket Assembly, Container Handling Unit (CHU)	4-53.6
Lower Container Lock, Front Lift Adapter	4-53.12
Short Strut and Pin Bracket Assembly, Container Handling Unit (CHU)	4-53.4
Slider/Pivot Assembly, Container Handling Unit (CHU)	4-53.2
Slider Arm Assembly, Container Handling Unit (CHU)	5-28.1
Repair Parts	5-3
Replacement	
Reverse Alarm	4-44
Angled Roller	4-47
Bumper Stop Stinger Bracket	4-49
Clearance Light	4-42
Container Handling Unit (CHU), Front Crossmember Assembly	4-53.14
Control Box	
Assembly, Container Handling Unit (CHU)	4-34.1
Wiring, Container Handling Unit (CHU)	4-34.2
Data Plate	4-52
Deck Assembly	4-53
Front	
Crossmember Assembly, Container Handling Unit (CHU)	4-53.14
Lift Adapter Assembly, Container Handling Unit (CHU)	4-53.8
Lift Adapter Locking Plate Assembly, Container Handling Unit (CHU)	4-53.9
Horizontal Roller	4-46
Housing	4-57
Hydraulic Filter	4-57
Hydraulic Hose	4-58
Hydraulic Selector Switch	4-31
Jumper Wire Harness, Container Handling Unit (CHU)	4-33.1
Ladder Bracket	4-51.1
Load Handling System (LHS)	
Check Valve	5-42
Circuit Breaker	4-33

INDEX (CONT)

Subjects	Paragraph, Figure, Table Number
R (cont)	
Replacement (cont)	
Load Handling System (LHS) (cont)	
Directional Control Valve	5-35
Distribution Box	4-34
Hook	5-22
Hook Arm Cylinder	5-37
Junction Box	4-41
Load Control Valve Main Frame	5-41
Main Frame Cylinder	5-40
Main Frame Nose Support	5-28
Main Frame Tube	5-25
Main Manifold Relief Valve	5-33
Main Manifold/Bracket	5-31
Main Wire Harness	5-19
Mounting Bracket	5-27
Rear Roller Assembly Mounting Bracket, Load Handling System (LHS)	5-27.1
Rectifier	4-40
Rubber Bumper	5-21
Transit Valve	5-32
Main Frame	
Lockout Relay	4-38
Proximity Switch, Container Handling Unit (CHU)	4-37.2
Marker Light	4-42
Mud Flap, Center	4-51
Parts, Mandatory Replacement	T K-1
Pilot Light Housing	4-32
Proximity Switch	
Container Handling Unit (CHU)	4-37.1
(Hook Arm Down)	4-35
(Hook Arm Up)	4-36
(Main Frame Down)	4-37
Rear	
Bracket Assembly, Container Handling Unit (CHU)	4-53.5
Fender Replacement	4-50
Guide, Container Handling Unit (CHU), Self-Recovery Winch (SRW)	4-53.10
Light Bar Assembly	4-43
Container Handling Unit (CHU)	4-43.1
Lock Limit Switch, Container Handling Unit (CHU)	4-45.1
Roller Assembly	4-48
Reversal Alarm	
Wiring Harness	5-20
Switch	4-45
Safe Lowering Button	4-39
Sensing Plate, Container Handling Unit (CHU)	4-37.1
Slicer Wear Plate, Container Handling Unit (CHU)	4-53.3
Stowage Tray, Container Handling Unit (CHU)	4-53.7

INDEX (CONT)

Subjects	Paragraph, Figure, Table Number
R (cont)	
Replacement (cont)	
Wiring Harness	
Reversal Alarm	5-20
Container Handling Unit (CHU)	4-33.2
Report	
Equipment Improvement and Maintenance Digest and Equipment Improvement and Maintenance Summary	1-3
Submitting Quality Deficiency	1-5
Reporting Equipment Improvement Recommendations (EIR)	4-6
Reports, Maintenance, Forms, and Records	4-2
Reversal Alarm	
Wiring Harness, Replacement	5-20
Switch Replacement	4-45
Roller	
Angled, Replacement	4-47
Horizontal, Replacement	4-46
Rear, Assembly Replacement	4-48
Rubber Bumper, Load Handling System (LHS), Replacement	5-21
S	
Safe Lowering Button Replacement	4-39
Scope	1-1
	4-1
Self-Recovery Winch (SRW), Container Handling Unit (CHU), Rear Guide, Replacement	4-53.10
Selector Switch, Hydraulic, Replacement	4-6
Sensing Plate, Container Handling Unit (CHU), Replacement/Adjustment	4-37.1
Service Upon Receipt Instructions	4-12
Services, Preventive Maintenance Checks	2-5
Services Tables, Operator/Crew Preventive Maintenance Checks	2-8
Shipment	
Preparation	5-17
	4-28
Instructions	4-27
Introduction	5-16
Short Strut, Container Handling Unit (CHU), Repair	4-53.4
Slider	
Arm Assembly, Container Handling Unit (CHU), Repair	5-28.1
Assembly, Container Handling Unit (CHU), Repair	4-53.2
Wear Plate, Container Handling Unit (CHU), Replacement	4-53.3
Special Tools, TMDE, and Support Equipment	4-4
	5-2
Stacking, M3 CROP on Trailer	2-10.8
Stinger, Bumper Stop, Bracket Replacement	4-49

INDEX (CONT)

Subjects	Paragraph, Figure, Table Number
S (cont)	
Storage	
Preparation	5-17 4-28
Instructions	4-27
Introduction	5-16
Storage Maintenance Procedures	5-18
Stowage Tray, Container Handling Unit (CHU), Replacement	4-53.7
Systems Introduction	1-12
T	
Technical Manuals	A-4
Test Equipment	
Tools, Tool Kits General	B-4
Tightening	
General, Sequences	F 5-1 F 4-1
Tools	
Common Equipment	5-1
Special, TMDE, and Support Equipment	5-2 4-4
Tool Kits General, Test Equipment, Tools	B-4
Torque Limits For	
37-Degree Flare Hose Connections	T J-5
45-Degree Flare Hose Connections	T J-6
Dry Fasteners	T J-3
NPSM Swivel Connections	T J-8
ORS Preformed Packing Face Seal Hose Connections	T J-7
Wet Socket Head Cap Screws	T J-2
Wet Fasteners	T J-4
Wet Flange Nuts	T J-1
Transit Valve, Load Handling System (LHS), Replacement	5-32
Transport	
Rail	2-10.12
Configuring for Air/Sea	2-11
with HEMTT LHS Without Container, Lifting Frame	2-10.6
Troubleshooting	
Introduction	5-6 3-2.1
Direct Support, Procedures	5-7
General Support, Procedures	5-7
Instructions	4-18
Load Handling System (LHS)	4-17 5-5
Procedures	3-3
Table	
Direct Support	T 5-2
General Support	T 5-2

INDEX (CONT)

Subjects	Paragraph, Figure, Table Number
U	
Unit Level Preventive Maintenance Checks and Services (PMCS)	T 4-1
Unloading	
Container (48 Inches)	2-10.5
Container (72 Inches)	2-10.3
Container (82 Inches)	2-10.2
ISO Container, M3 CROP	2-10.9
Upon Receipt	
Inspection, Instructions	4-11
	5-4
Service, Instructions	4-12
V	
Vehicle, Clean	3-5
W	
Warranty Information	1-6
Washer, LHS	H-6
■ Wear Pad, Container Handling Unit (CHU), Replacement	4-53.16
Wire Harness, General, Repair	4-30
Wiring Harness	
Reversal Alarm, Replacement	5-20
■ Container Handling Unit (CHU), Replacement	4-33.2
Wooden Blocks	H-1
	T H-1

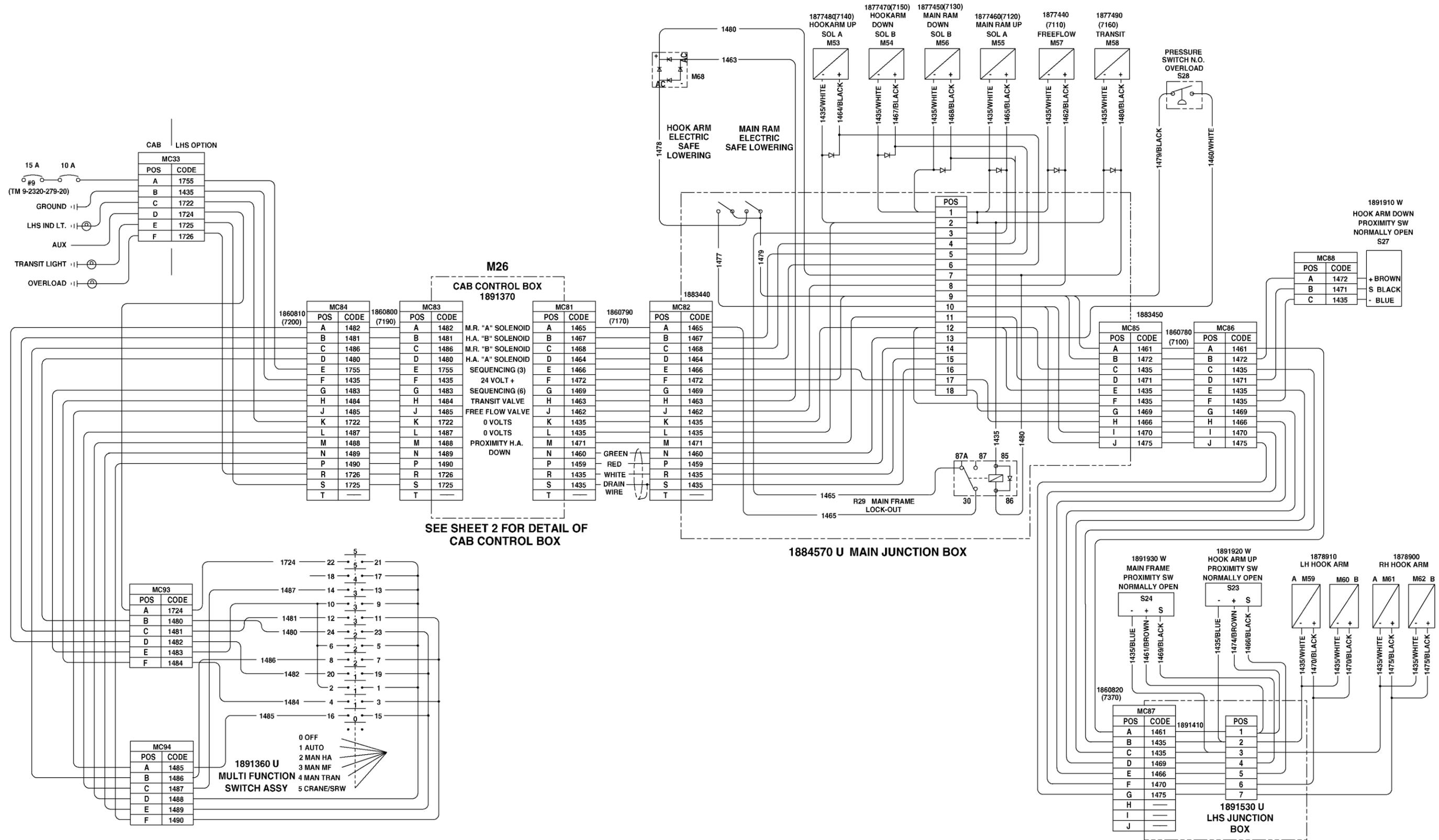

SEE SHEET 2 FOR DETAIL OF CAB CONTROL BOX

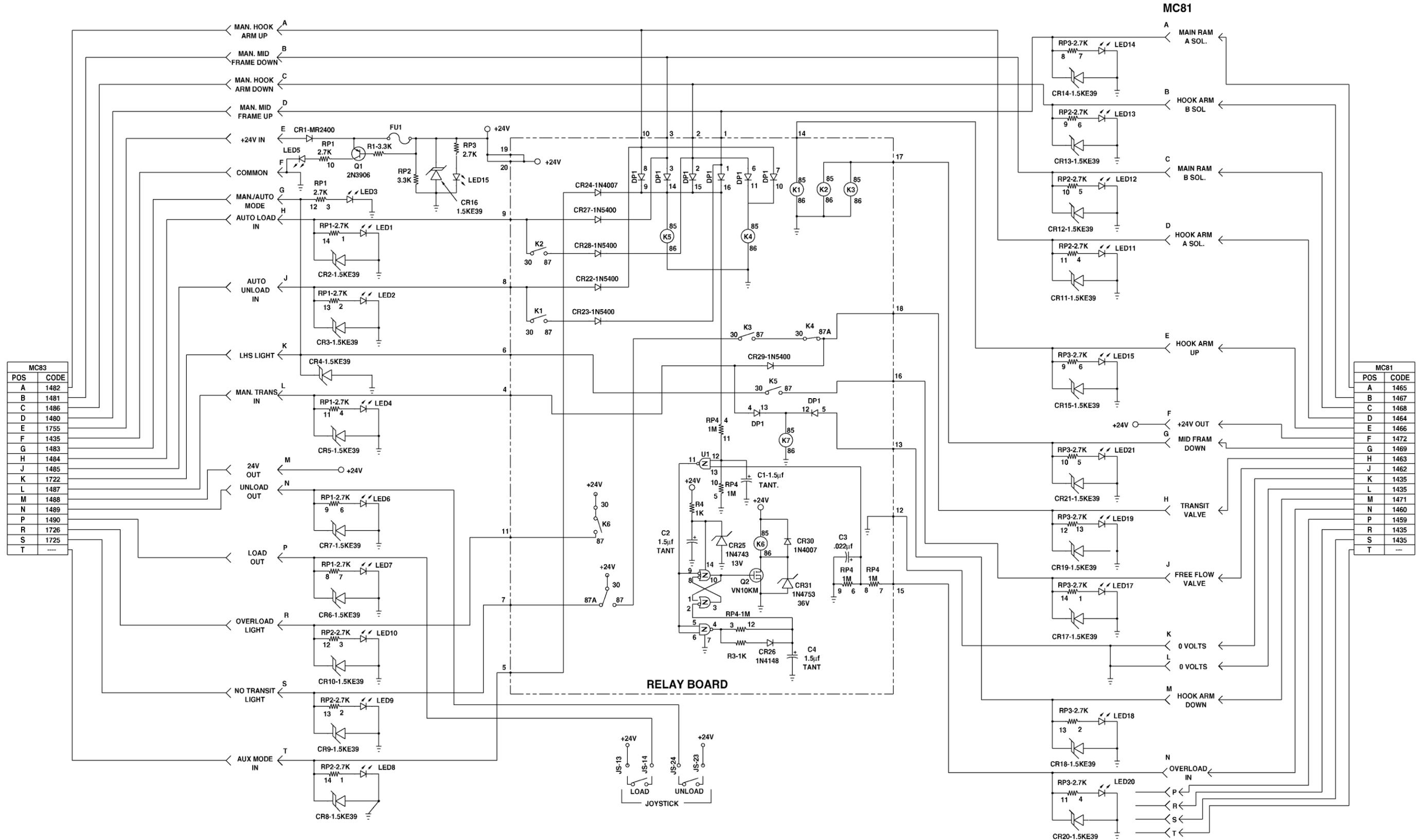

MC83	
POS	CODE
A	1482
B	1481
C	1486
D	1480
E	1755
F	1435
G	1483
H	1484
J	1485
K	1722
L	1487
M	1488
N	1489
P	1490
R	1726
S	1725
T	---

MC81	
POS	CODE
A	1465
B	1467
C	1468
D	1464
E	1466
F	1472
G	1469
H	1463
J	1462
K	1435
L	1435
M	1471
N	1460
P	1459
R	1435
S	1435
T	---

FO-1. LHS Wiring Schematic (Sheet 2 of 2).
FP-3/(FP-4 blank)

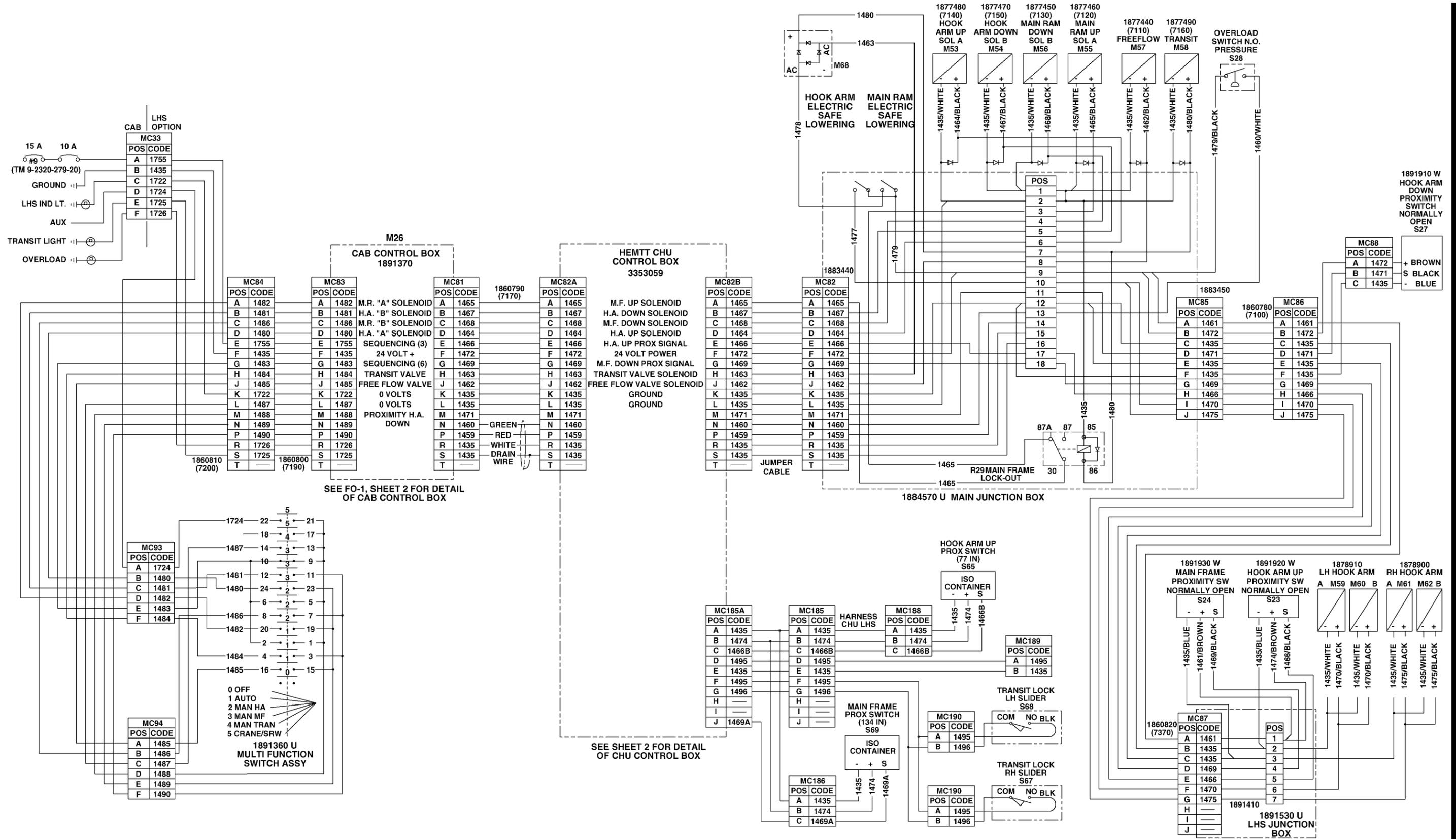

FO-1.1 LHS-CHU Wiring Schematic (Sheet 1 of 2).
Change 1 FP-4.1/(FP-4.2 blank)

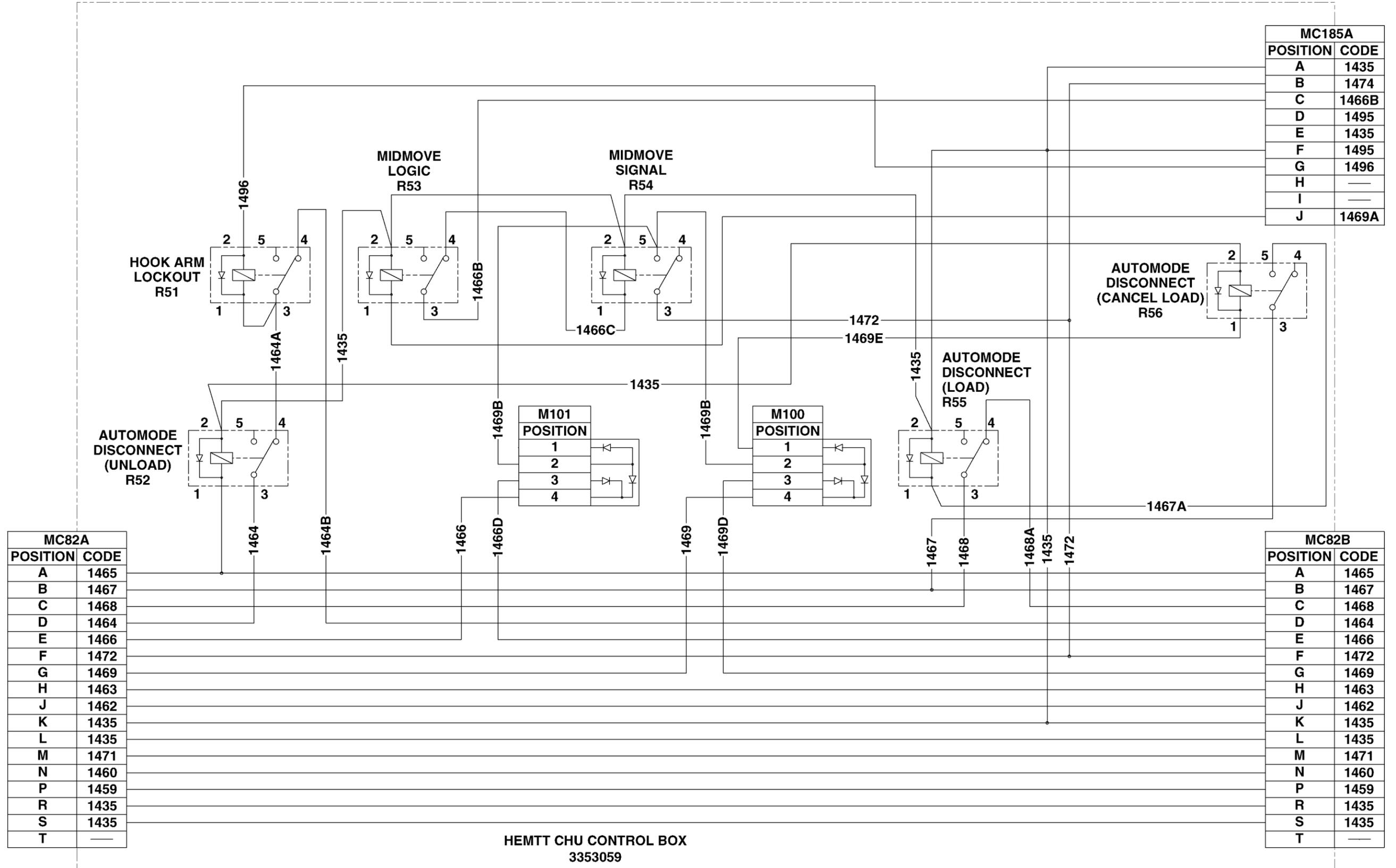

MC82A	
POSITION	CODE
A	1465
B	1467
C	1468
D	1464
E	1466
F	1472
G	1469
H	1463
J	1462
K	1435
L	1435
M	1471
N	1460
P	1459
R	1435
S	1435
T	—

MC185A	
POSITION	CODE
A	1435
B	1474
C	1466B
D	1495
E	1435
F	1495
G	1496
H	—
I	—
J	1469A

MC82B	
POSITION	CODE
A	1465
B	1467
C	1468
D	1464
E	1466
F	1472
G	1469
H	1463
J	1462
K	1435
L	1435
M	1471
N	1460
P	1459
R	1435
S	1435
T	—

HEMTT CHU CONTROL BOX
3353059

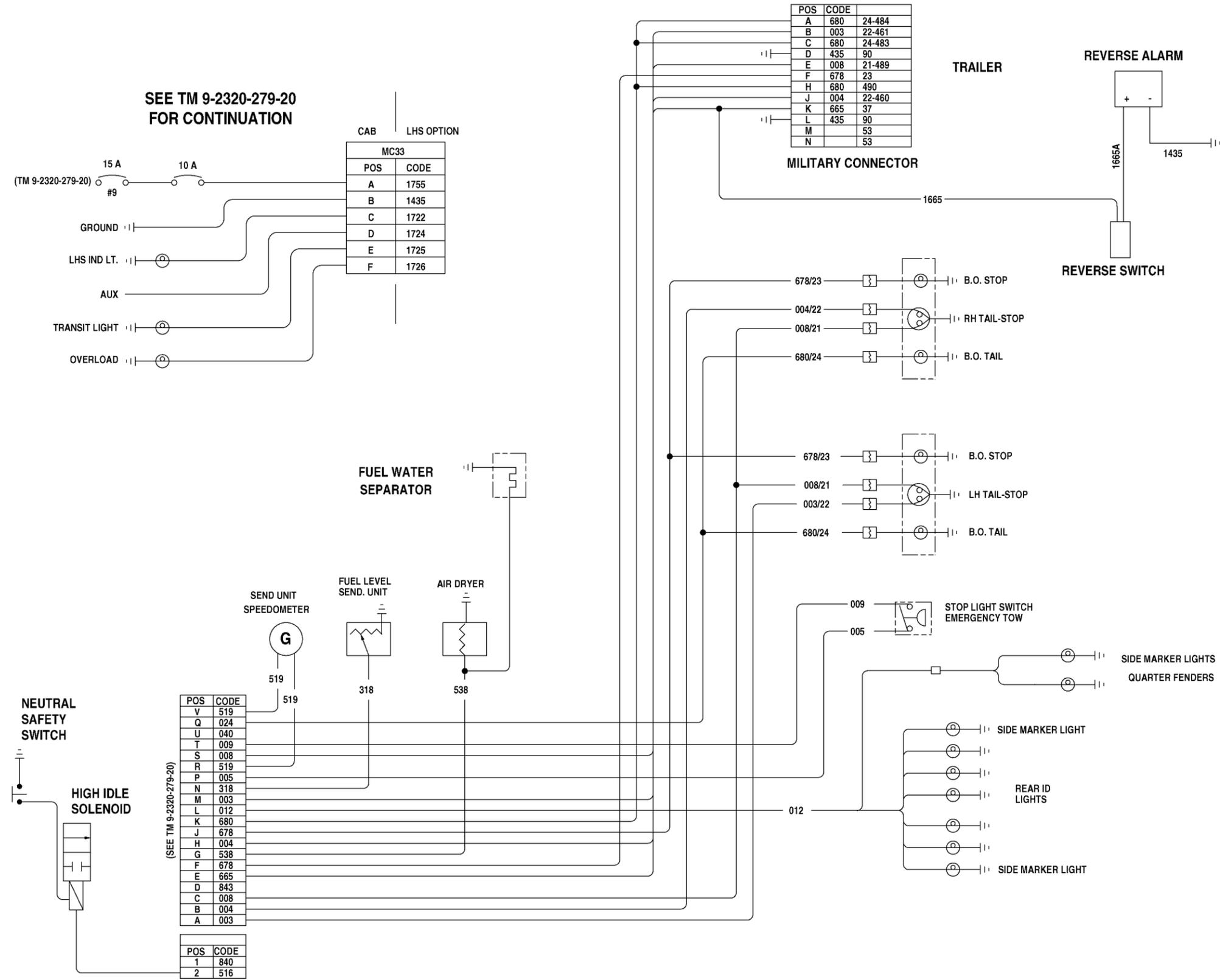

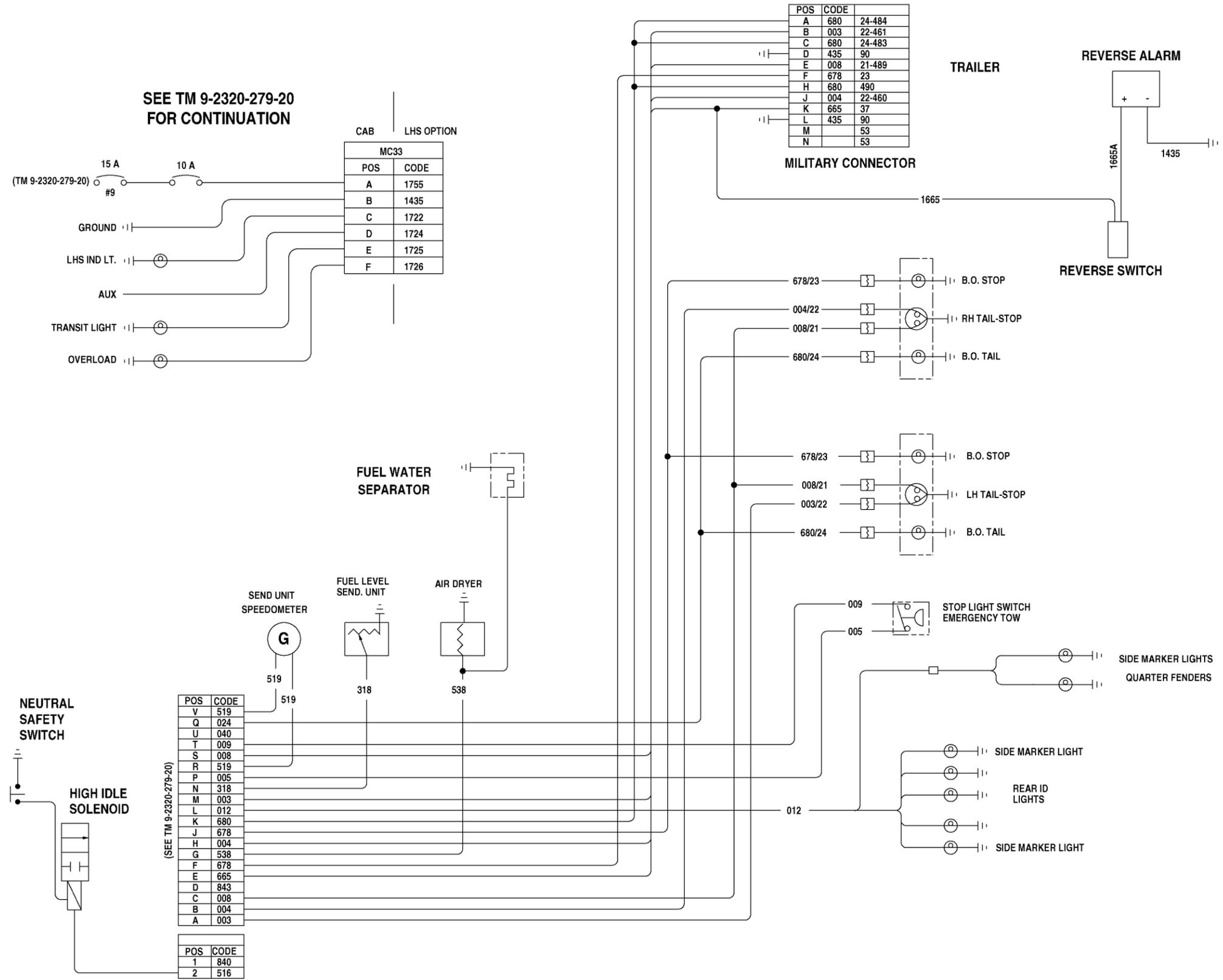

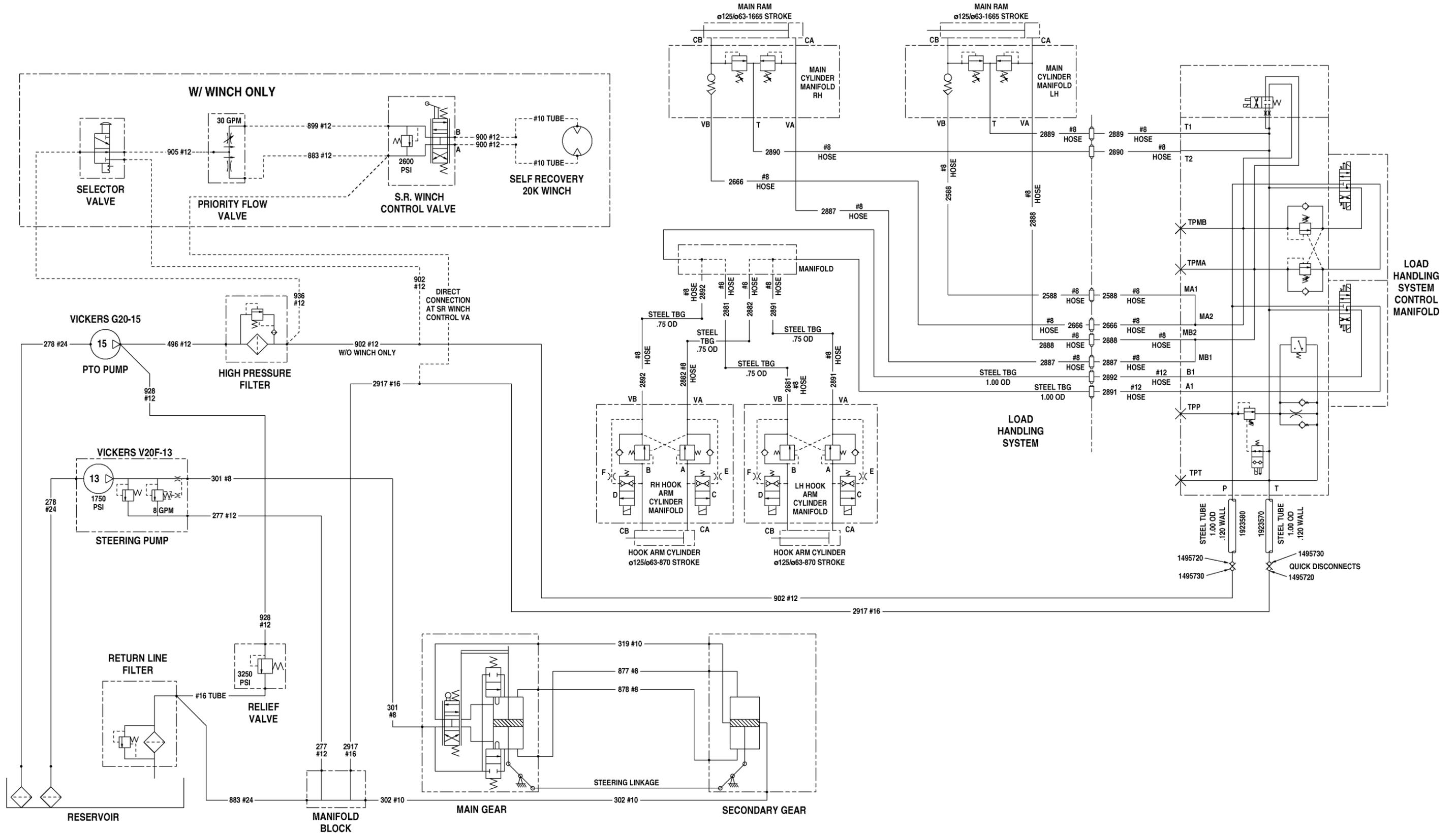

FO-3. Hydraulic Schematic.
FP-7/(FP-8 blank)

By Order of the Secretary of the Army:

Official:

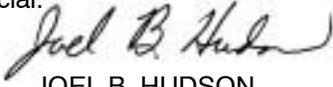

JOEL B. HUDSON
*Administrative Assistant to the
Secretary of the Army*

0017513

ERIC K. SHINSEKI
*General, United States Army
Chief of Staff*

DISTRIBUTION: To be distributed in accordance with the Initial Distribution Number (IDN) 381091, requirements for TM 9-2320-304-14&P.

RECOMMENDED CHANGES TO EQUIPMENT PUBLICATIONS



THEN - JOT DOWN THE INFO ON THIS FORM---TEAR OUT THIS PAGE---FOLD IT---AND DROP IT IN THE MAIL!

SOMETHING WRONG WITH THIS PUBLICATION?

FROM: (IMPRINT YOUR UNIT'S COMPLETE ADDRESS)

DATE SENT:

PUBLICATION NUMBER

TM 9-2320-304-14&P

PUBLICATION DATE

15 August, 2000

PUBLICATION TITLE

Operators, Unit, and DS/GS Maintenance Manual, Including RPSTL, for Load Handling System

BE EXACT...PINPOINT WHERE IT IS

PAGE NO.	PARA-GRAPH	FIGURE NO.	TABLE NO.
1-2	1-1		
3-1	3-2		
3-8	3-5		

IN THIS SPACE, TELL WHAT IS WRONG AND WHAT SHOULD BE DONE ABOUT IT:

*Truck illustration does not show fuel return line.
Reason: Fuel return line runs on top of fuel tank.*

Text refers to cleaning solvent item 7, App. D in Expendable Supplies Section. Reason: Should be item 18, App. E.

*Truck illustration not accurate as shown.
Reason: Truck should be a HEMTT (4 axles).*

SAMPLE

PRINTED NAME, GRADE OR TITLE, AND TELEPHONE NUMBER

SSG. TED RYBA 671-3681

SIGN HERE:

SSG Ted Ryba

DA FORM 1 JUL 79 **2028-2**

PREVIOUS EDITIONS ARE OBSOLETE.

P.S. IF YOUR OUTFIT WANTS TO KNOW ABOUT YOUR RECOMMENDATION, MAKE A CARBON COPY OF THIS AND GIVE IT TO YOUR HEADQUARTERS.

TEAR ALONG PERFORATED LINE

SAMPLE

FILL IN YOUR
UNIT'S ADDRESS



FOLD BACK

DEPARTMENT OF THE ARMY

OFFICIAL BUSINESS



NOTE:
Apply Stamp

**Commander
US Army Tank-automotive and Armaments Command
ATTN: AMSTA-LC-CIP-WT
Rock Island, IL 61299-7630**

TEAR ALONG PERFORATED LINE

FILL IN YOUR
UNIT'S ADDRESS



FOLD BACK

DEPARTMENT OF THE ARMY

OFFICIAL BUSINESS



NOTE:
Apply Stamp

Commander
US Army Tank-automotive and Armaments Command
ATTN: AMSTA-LC-CIP-WT
Rock Island, IL 61299-7630

TEAR ALONG PERFORATED LINE

THE METRIC SYSTEM AND EQUIVALENTS

WEIGHT MEASURE

1 Centimeter = 10 Millimeters = 0.01 Meters = 0.3937 Inches
 1 Meter = 100 Centimeters = 1000 Millimeters = 39.37 Inches
 1 Kilometer = 1000 Meters = 0.621 Miles

WEIGHTS

1 Gram = 0.001 Kilograms = 1000 Milligrams = 0.035 Ounces
 1 Kilogram = 1000 Grams = 2.2 lb.
 1 Metric Ton = 1000 Kilograms = 1 Megagram = 1.1 Short Tons

LIQUID MEASURE

1 Milliliter = 0.001 Liters = 0.0338 Fluid Ounces
 1 Liter = 1000 Milliliters = 33.82 Fluid Ounces

SQUARE MEASURE

1 Sq. Centimeter = 100 Sq. Millimeters = 0.155 Sq. Inches
 1 Sq. Meter = 10,000 Sq. Centimeters = 10.76 Sq. Feet
 1 Sq. Kilometer = 1,000,000 Sq. Meters = 0.386 Sq. Miles

CUBIC MEASURE

1 Cu. Centimeter = 1000 Cu. Millimeters = 0.06 Cu. Inches
 1 Cu. Meter = 1,000,000 Cu. Centimeters = 35.31 Cu. Feet

TEMPERATURE

$5/9(^{\circ}\text{F} - 32) = ^{\circ}\text{C}$
 212° Fahrenheit is equivalent to 100° Celsius
 90° Fahrenheit is equivalent to 32.2° Celsius
 32° Fahrenheit is equivalent to 0° Celsius
 $9/5^{\circ}\text{C} + 32 = ^{\circ}\text{F}$

APPROXIMATE CONVERSION FACTORS

TO CHANGE	TO	MULTIPLY BY
Inches	Centimeters	2.540
Feet	Meters	0.305
Yards	Meters	0.914
Miles	Kilometers	1.609
Square Inches	Square Centimeters	6.451
Square Feet	Square Meters	0.093
Square Yards	Square Meters	0.836
Square Miles	Square Kilometers	2.590
Acres	Square Hectometers	0.405
Cubic Feet	Cubic Meters	0.028
Cubic Yards	Cubic Meters	0.765
Fluid Ounces	Milliliters	29.573
its	Liters	0.473
arts	Liters	0.946
allons	Liters	3.785
Ounces	Grams	28.349
Pounds	Kilograms	0.454
Short Tons	Metric Tons	0.907
Pound-Feet	Newton-Meters	1.356
Pounds per Square Inch	Kilopascals	6.895
Miles per Gallon	Kilometers per Liter	0.425
Miles per Hour	Kilometers per Hour	1.609

TO CHANGE	TO	MULTIPLY BY
Centimeters	Inches	0.394
Meters	Feet	3.280
Meters	Yards	1.094
Kilometers	Miles	0.621
Square Centimeters	Square Inches	0.155
Square Meters	Square Feet	10.764
Square Meters	Square Yards	1.196
Square Kilometers	Square Miles	0.386
Square Hectometers	Acres	2.471
Cubic Meters	Cubic Feet	35.315
Cubic Meters	Cubic Yards	1.308
Milliliters	Fluid Ounces	0.034
Liters	Pints	2.113
Liters	Quarts	1.057
ers	Gallons	0.264
ms	Ounces	0.035
ograms	Pounds	2.205
Metric Tons	Short Tons	1.102
Newton-Meters	Pounds-Feet	0.738
Kilopascals	Pounds per Square Inch	0.145
ometers per Liter	Miles per Gallon	2.354
ometers per Hour	Miles per Hour	0.621

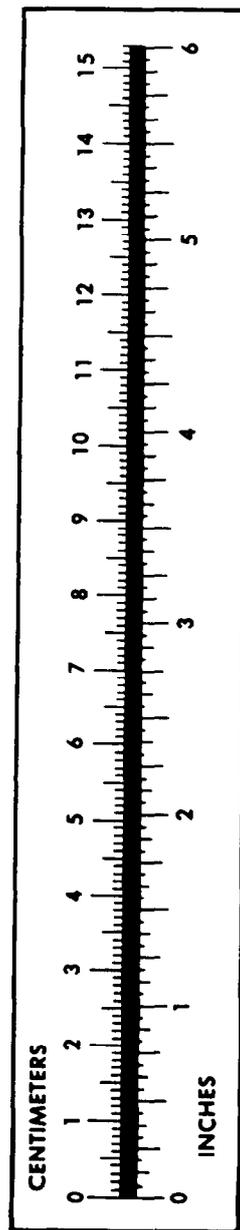

PIN: 078239-001